

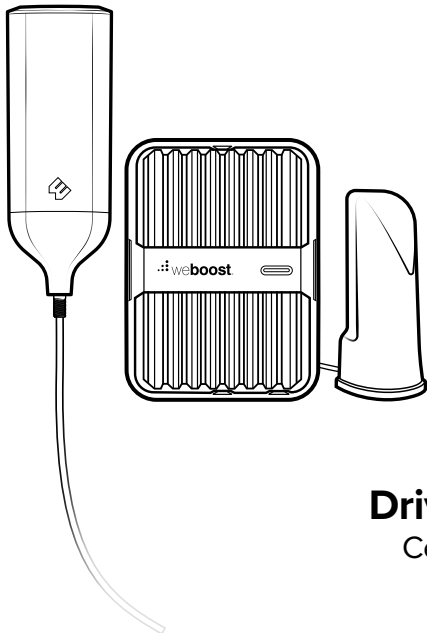

## Installation Guide



## Drive Reach RV Cell Signal Booster

## Index

Package Contents .....	1
STEP 1 Mount Outside Antenna & Route Cable .....	2
STEP 2 Connect Cable Outside Antenna .....	6
STEP 3 Inside Antenna Location & Connect Cable .....	6
STEP 4 Booster Location & Connect Cables .....	7
STEP 5 Connect Power Supply to Booster .....	7
Booster Light Patterns .....	8
Troubleshooting .....	10
Safety Guidelines .....	12
Specifications .....	15
Warranty .....	16

## Package Contents

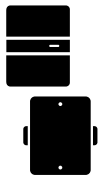

Drive Reach  
Signal Booster  
& Bracket

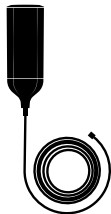

Outside  
Antenna



Inside  
Antenna



Power  
Supply

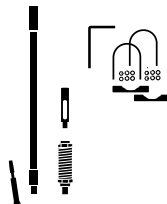

13 in. Mast Extension,  
Side-Exit Adapter,  
Spring, L-Bracket  
Mount & Thread  
Lock Pack

## STEP 1 Mount Outside Antenna & Route Cable

Determine where you want the Outside Antenna on your RV. **Mount Outside Antenna** to a ladder or pole so that the entire Outside Antenna is above the roof line of the RV and clear of other metal obstructions.

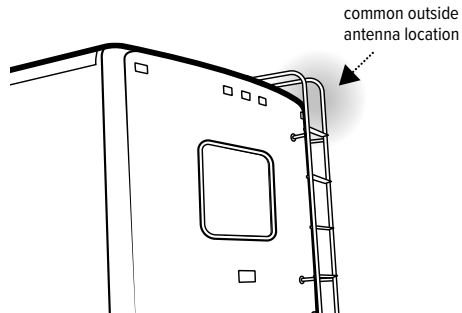

### Important

NOTE: Keep in mind to stay below the maximum height limit allowed by law, which varies from state to state (generally 14 ft. in western states and 13 ft.6 in. in eastern states).





## (STEP 1 cont.)

To assemble the antenna, insert cable through **Mast** then through **Side Exit Adapter**.

NOTE: Antenna Spring can be used optionally.

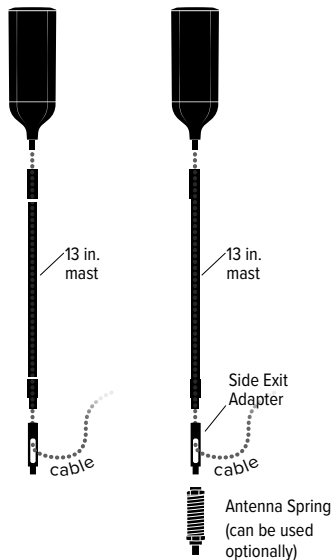
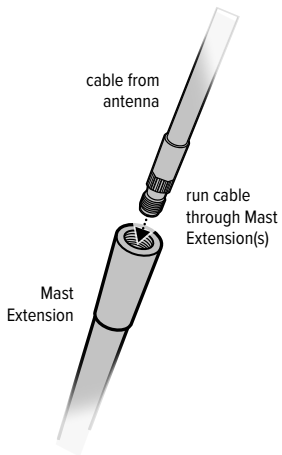

## (STEP 1 cont.)

Verify the antenna is the correct height, if so, use thread locker (provided) to thread points and screw into place.

NOTE: When adding the side exit adapter hold the antenna vertically and screw the adapter from the bottom up. This reduces cable twisting.

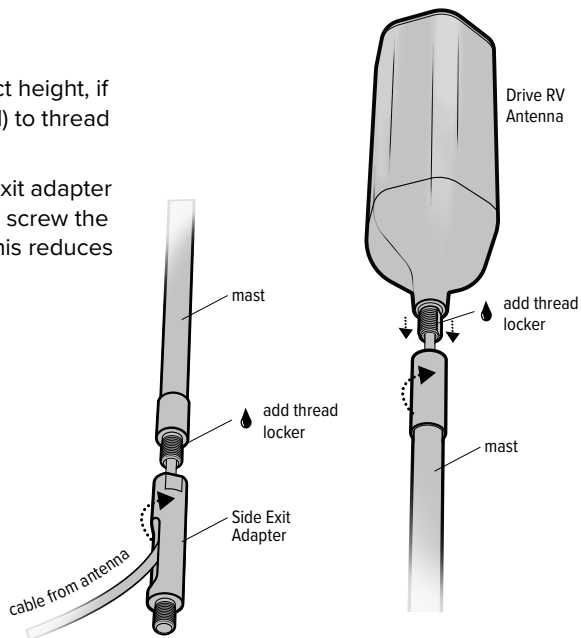

(STEP 1 cont.)

**Mount Outside Antenna. L-Bracket Mount and hardware** is provided to mount to ladder or pole. If installing with Spring, the Side Exit Adapter must be used. Then **route 25' RG-58 cable** from inside RV to Outside Antenna.

NOTE: Outside Antenna location must be within reach of the booster with the 25' coax cable. The system performs best with maximum vertical and horizontal separation.

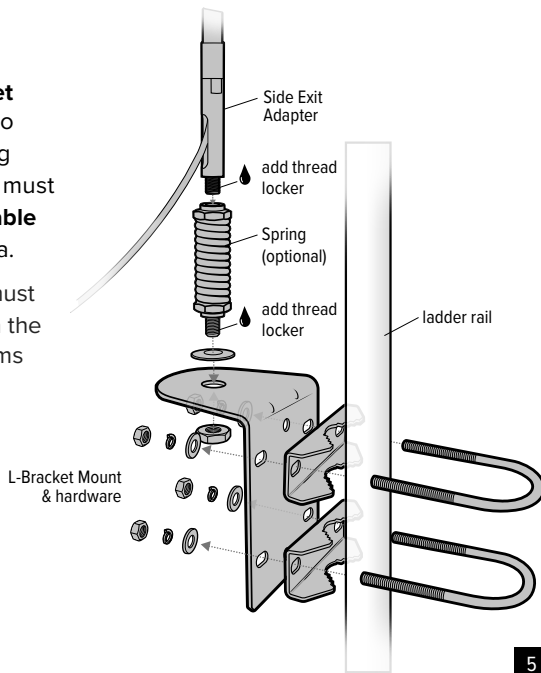

## STEP 2 Connect Cable to Outside Antenna

After routing the RG-58 Cable into the RV, **connect the cable to the Outside Antenna.**

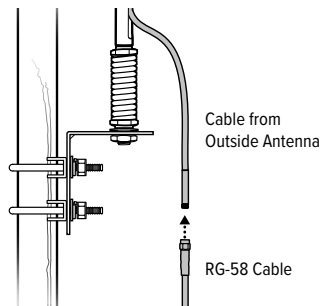

## STEP 3 Inside Antenna Location & Connect Cable

Place **Inside Antenna** where stronger signal is desired in the RV.

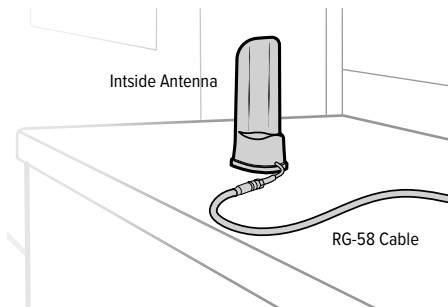

## STEP 4 Booster Location & Connect Cables

Find a location to place the **Drive Reach Booster** and secure it with provided bracket. **Connect cable from Outside Antenna** to labeled booster port and **connect cable from Inside Antenna** to labeled booster port.

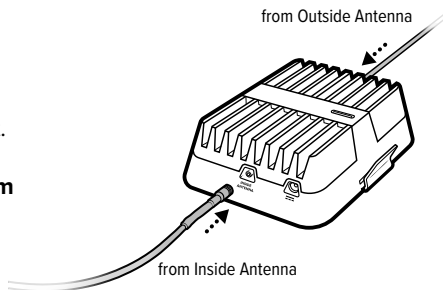

## STEP 5 Connect Power Supply to Booster

Connect the power supply cord to the end of the booster, labeled “”, and connect into a 110V wall plug. Enjoy your boosted signal!

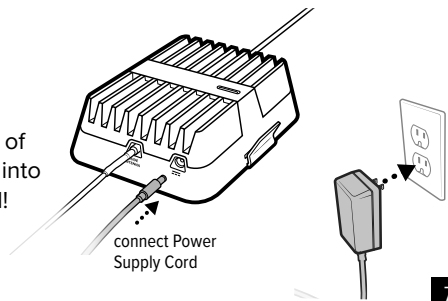

## Booster Light Patterns

### SOLID GREEN

This indicates that your Drive Reach Booster is functioning properly and there are no issues with installation.

### SOLID RED

Band has shutoff. This is due to a feedback loop condition called oscillation. This is a built in safety feature that causes a band to shut off to prevent harmful interference with a nearby cell tower. Refer to Troubleshooting section.

### BLINKING RED, THEN SOLID GREEN

This indicates that one or more of the booster bands has reduced power due to a minor feedback loop condition called oscillation. This is a built in safety feature to prevent harmful interference with a nearby cell tower. If you are already experiencing the desired signal boost, then no further adjustments are necessary. If you are not experiencing the desired boost in coverage then refer to the Troubleshooting section.

### Light Off

If the Drive Reach Signal Booster's light is off, verify your power supply has power.

## (Booster Light Patterns cont.)

NOTE: The Signal Booster can be reset by disconnecting and reconnecting the power supply.

After troubleshooting you must initiate a new power cycle by disconnecting and then reconnecting power to the Booster.

## Troubleshooting

### FIXING BLINKING OR RED LIGHT ISSUES

**This section is only applicable if the booster is red or blinking red and you are not experiencing the desired signal boost.**

- 1 Unplug the Booster's power supply.
- 2 Relocate the inside and outside antenna further from each other. The objective is to increase the separation distance between them, so that they will not create this feedback condition discussed before.
- 3 Plug power supply back in.
- 4 Monitor the indicator light on your booster. If, after a few seconds of 'power on', a solid or blinking red light appears, repeat steps 1 through 3. Increase the separation distance until the condition is corrected and/or desired coverage area is achieved. Note: Horizontal separation of the two antennas typically requires a shorter separation distance than vertical separation.

If you are having any difficulties while testing or installing your booster, contact our weBoost Customer Support team for assistance (866.294.1660).



## (Troubleshooting cont.)

### FREQUENTLY ASKED QUESTIONS

#### **How can I contact customer support?**

Customer Support can be reached Monday thru Friday by calling 866.294.1660, or through our support site at [support.weboost.com](http://support.weboost.com).

#### **Why do I need to create distance between the booster and the antenna?**

Antennas connected to a booster create spheres of signal. When these spheres overlap, a condition called oscillation occurs. Oscillation can be thought of as noise, which causes the booster to scale down its power or shut down to prevent damage. The best way to keep these spheres of signal from overlapping is to maximize separation between the inside and outside antennas.

---

 1.866.294.1660

 [www.wilsonelectronics.com](http://www.wilsonelectronics.com)

 [support@wilsonelectronics.com](mailto:support@wilsonelectronics.com)

---

## Safety Guidelines

Use only the power supply provided in this package. Use of a non-weBoost product may damage your equipment.

Connecting this signal booster directly to the cell phone with use of an adapter will damage the cell phone.

RF Safety Warning: Any antenna used with this device must be located at least 8 inches from all persons.

AWS Warning: The Outside Antenna must be installed no higher than 10 meters (31'9") above ground.

### **This is a CONSUMER device.**

---

**BEFORE USE**, you **MUST REGISTER THIS DEVICE** with your wireless provider and have your provider's consent. Most wireless providers consent to the use of signal boosters. Some providers may not consent to the use of this device on their network. If you are unsure, contact your provider.

You **MUST** operate this device with approved antennas and cables as specified by the manufacturer. Antennas **MUST** be installed at least 20 cm (8 inches) from any person.

You **MUST** cease operating this device immediately if requested by the FCC or licensed wireless service provider.

**WARNING.** E911 location information may not be provided or may be inaccurate for calls served by using this device.

## (Safety Guidelines cont.)

**FOR MORE INFORMATION ON REGISTERING YOUR SIGNAL BOOSTER WITH YOUR WIRELESS PROVIDER, PLEASE SEE BELOW:**

**Sprint:** <http://www.sprint.com/en/legal/signal-boosters.html?search=booster>

**T-Mobile/MetroPCS:** <https://support.t-mobile.com/docs/DOC-9827>

**Verizon Wireless:** <http://www.verizonwireless.com/wcms/consumer/register-signal-booster.html>

**AT&T:** <https://securec45.securewebsession.com/attsignalbooster.com/>

**U.S. Cellular:** <http://www.uscellular.com/uscellular/support/fcc-booster-registration.jsp>

## Antenna Info

The following accessories are certified by the FCC to be used with the Drive Reach Booster.

### MOBILE INSIDE ANTENNA KIT OPTIONS

Kit #	Coax Type	Ln(ft)	Antenna Type	Ω
314419	LMR-100	10	4G Slim Low Profile SMB	50

### MOBILE OUTSIDE ANTENNA KIT OPTIONS

Kit #	Coax Type	Ln(ft)	Antenna Type	Ω
311217	LMR-100	10	Mini-Mag SMB	50
304415	RG-58	15	4G Trucker	50
304420	RG-195	20	4G Marine	50
311104-5810	RG-58	10	NMO	75
311112-5810	RG-58	10	NMO Antenna	75
311125	RG-58	12.5	12' Mag Mount	50
311224-19530	RG-195	30	4G RV OTR	50
311224-0630	RG-6	25	4G RV OTR	75
314203-5810	RG-58	10	800/900/1900 NMO	50
314405	RG-58	10	4G NMO	50

## Specifications

Drive Reach Cell Signal Booster					
Model	460054				
FCC	PWO460054				
Connectors	SMB-Jack				
Antenna Impedence	50 Ohms				
Frequency	698-716 MHz, 728-756 MHz, 777-787 MHz, 824-894 MHz, 1850-1995 MHz, 1710-1755/2110-2155 MHz				
Power output for single cell phone (Uplink) dBm	<b>700 MHz B12/17</b> 28.3	<b>700 MHz B13</b> 29.1	<b>800 MHz B5</b> 29.50	<b>1700 MHz B4</b> 28.50	<b>1900 MHz B2</b> 28.30
Power output for single cell phone (Downlink) dBm	5.2	5.2	5.2	5.0	5.1
Noise Figure	5 dB (nominal)				
Isolation	> 90 dB				
Power Requirements	5V, 4.5A				

Each Signal Booster is individually tested and factory set to ensure FCC compliance. The Signal Booster cannot be adjusted without factory reprogramming or disabling the hardware. The Signal Booster will amplify, but not alter incoming and outgoing signals in order to increase coverage of authorized frequency bands only. If the Signal Booster is not in use for five minutes, it will reduce gain until a signal is detected. If a detected signal is too high in a frequency band, or if the Signal Booster detects an oscillation, the Signal Booster will automatically turn the power off on that band. For a detected oscillation the Signal Booster will automatically resume normal operation after a minimum of 1 minute. After 5 (five) such automatic restarts, any problematic bands are permanently shut off until the Signal Booster has been manually restarted by momentarily removing power from the Signal Booster. Noise power, gain, and linearity are maintained by the Signal Booster's microprocessor.

This device complies with Part 15 of FCC rules. Operation is subject to two conditions: (1) This device may not cause harmful interference, and (2) this device must accept any interference received, including interference that may cause undesired operation. Changes or modifications not expressly approved by weBoost could void the authority to operate this equipment.

## ✔ 2 YEAR WARRANTY

Antennas may also be returned directly to the manufacturer at the consumer's expense, with a dated proof of purchase and a Returned Material Authorization (RMA) number supplied by Wilson Electronics. Wilson Electronics shall, at its option, either repair or replace the product. Wilson Electronics will pay for delivery of the repaired or replaced product back to the original consumer if located within the continental U.S.

Replacement products may include refurbished Wilson Electronics products that have been recertified to conform with product specifications.

This warranty does not apply to any antennas determined by Wilson Electronics to have been subjected to misuse, abuse, neglect, or mishandling that alters or damages physical or electronic properties.

RMA numbers may be obtained by contacting Technical Support at 866-294-1660.

**DISCLAIMER:** The information provided by Wilson Electronics, LLC is believed to be complete and accurate. However, no responsibility is assumed by Wilson Electronics, LLC for any business or personal losses arising from its use, or for any infringements of patents or other rights of third parties that may result from its use.

**MARKETING APPROVAL:** Installer and end customer hereby grants to Wilson Electronics the express right to use installers or end customers company logo in marketing, sales, financial, and public relations materials and other communications solely to identify Customer as a Wilson Electronics customer.

## Notes

---

---

---

---

---

---

---

---

---

---

---

---

---

---

---

---

---

---

---

---

---

---

---

---

---



 1.866.294.1660

 [www.wilsonelectronics.com](http://www.wilsonelectronics.com)

 [support@wilsonelectronics.com](mailto:support@wilsonelectronics.com)



3301 East Deseret Drive, St. George, UT

 866.294.1660  [www.wilsonelectronics.com](http://www.wilsonelectronics.com)  [support@wilsonelectronics.com](mailto:support@wilsonelectronics.com)

Copyright © 2020 Wilson Electronics. All rights reserved. Wilson Electronics products covered by U.S. patent(s) and pending application(s) For patents go to: [weboost.com/us/patents](http://weboost.com/us/patents)

NOT AFFILIATED WITH WILSON ANTENNA

GDE000290\_Rev01\_09.21.20