

- 1 Tilt the TV up to gain access to the back of your TV.
- 2 Connect the cables.
- 3 Tilt the TV up or down to achieve the best angle of view.

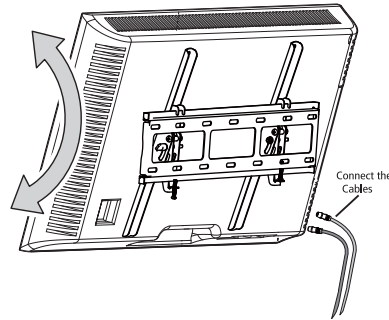

SUNCRAFT SOLUTIONS INC. LIMITED WARRANTY

SUNCRAFT SOLUTIONS, INC. warrants its products to be free of defects in material and workmanship for the product's Warranty Period. The Warranty Period commences on the original purchase date of the product and the sales receipt serves as proof of purchase.

All SUNCRAFT SOLUTIONS, INC. products are covered by a limited product warranty of three (3) years for all metal mounts and fixtures and non electrical items.

This Limited Warranty extends only to the original purchaser and is non-transferable. It is automatically void if your SUNCRAFT SOLUTIONS, INC. product is modified or altered in any way, improperly or incompletely installed, usage of non-supplied hardware and used in a non-conventional method, exceeding the weight capacity or size restrictions, All SUNCRAFT SOLUTIONS, INC. products are intended for indoors consumer or commercial use only and any outdoor or use in areas subject to weather and high humidity, water vapor or exposure to the elements use voids this Limited Warranty. The Limited Warranty for all mounts is void if the mount is transferred from one location to another. To the maximum extent permitted by applicable law, SUNCRAFT SOLUTIONS, INC. disclaims any other warranties,

express or implied, including warranties of fitness for a particular purpose and warranties of merchantability. SUNCRAFT SOLUTIONS, INC. will not be liable for any damages whatsoever arising out of the use or inability to use its products, even if SUNCRAFT SOLUTIONS, INC. has been advised of the possibility of such damages. To the maximum extent permitted by applicable law, SUNCRAFT SOLUTIONS, INC. disclaims any responsibility for incidental or consequential injuries, damages to persons, properties and other items.

For warranty claims made during the stated warranty period, SUNCRAFT SOLUTIONS, INC. will replace any defective product part free of charge. Contact SUNCRAFT SOLUTIONS, INC. at 1-855-816-6868 to make a warranty claim or e-mail warranty@suncraftsolutions.com. Proof of warranty is required. This Limited Warranty does not cover the costs of removing and replacing defective parts from your SUNCRAFT SOLUTIONS, INC. product, SUNCRAFT SOLUTIONS, INC. assumes no liability for any installation, adjustment or other costs.

# STANLEY®

## TV Mount Installation Guide

Thank you for choosing Stanley – the hardware of choice for Architects, Contractors, and Home Owners for its quality, performance and dependability.

Enclosed are your step-by-step instructions for an install made easy.

11

Usage : Tilt

GENERAL DISCLAIMER

- 1 Tilt TV up or down to achieve the best angle of view. No tools required.
- 2 Your Stanley TV mount has been preset at a perfect tension to easily tilt most TVs. If you need to adjust the tilt tension, tighten or loosen the knob with a slotted screwdriver.

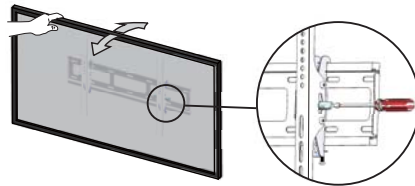

General Disclaimer

Disclaimer – Suncraft Solutions Inc. has extended every effort to ensure to accuracy and completeness of this manual. However, Suncraft Solutions Inc. does not claim that the information covers all installation, situational or operational variables. The information contained in this document is subject to change without notice or obligation of notification of any kind. Regarding the information contained herein, Suncraft Solutions Inc. makes no representation of warranty, expressed or implied, and assumes no responsibility for accuracy, sufficiency, or completeness of the information contained in this document.

**WARNING: FAILURE TO READ, THOROUGHLY UNDERSTAND, AND FOLLOW ALL INSTRUCTIONS CAN RESULT IN SERIOUS PERSONAL INJURY, DAMAGE TO PERSONAL PROPERTY, OR VOIDING OF LIMITED WARRANTY!**

It is the responsibility of the installer of this product to ensure all components are properly assembled and installed using the instructions provided. If you do not understand these instructions or have any questions or concerns, please contact customer service at 1-855-816-6868 or service@suncraftsolutions.com. Do not attempt to install or assemble this product if the product or hardware

is damaged or missing. In the event that replacement parts or hardware are needed, please contact Customer Service at 1-855-816-6868 or service@suncraftsolutions.com. International customers needing assistance should contact the Dealer from which they purchased the product.

The included hardware is designed for use on vertical walls constructed of wood studs or solid concrete. A wood stud wall is defined as consisting of a minimum of 2x4 wooden studs (1.5" wide by 3.5" deep 51 x 102 mm) with a maximum of 5/8" (16 mm) drywall. The included hardware is not designed for use with metal studs or cinderblock walls. If you are uncertain or unknowledgeable about the construction of your wall, then please consult a qualified contractor or professional installer for assistance. The wall you are mounting to must support 4 times the weight of the total load. The load is defined as the TV and Mount along with anything else suspended from the mount. If not, then the surface must be reinforced to meet this standard. The installer is responsible for verifying that the wall structure and hardware used in any installation method will safely support the total load.



12

Removing the TV

- 1 Disconnect all cables from the TV.
- 2 Unlock the secure screws.
- 3 Pull bottom of TV from wall, allow enough space to lift TV up and off wall plate.

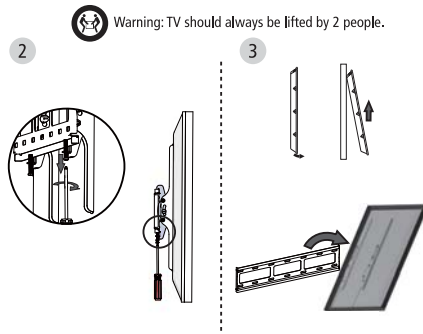

**Warning:** TV should always be lifted by 2 people.

To rehang TV, follow procedures on STEP 3 of PAGE 10.

13

If you get stuck, give customer service a call at 1-855-816-6868  
You can also reach us at [contact@stanleymounts.com](mailto:contact@stanleymounts.com)

[www.stanleymounts.com](http://www.stanleymounts.com)

**Caution:** Please read the entire manual before proceeding  
View warranty and disclaimer on page 14

## Getting Started

Before we start lets make sure we have the correct mount and all the required tools and hardware to complete the installation.

- ✓ The TV is a Flat Panel TV is between 32" - 70" and weighs no more than 90lbs.
- ✓ The Wall the TV will be mounted on is either concrete or dry wall with wood studs.
- ✓ You have all of the following tools:



Check out our free level app in the app store!

If you answer "Yes" to all the questions above then you are ready to begin the TV Mount installation!

2

**Caution:** This product contains small items that could be a choking hazard if swallowed.

## Parts & Hardware

**Caution:** Before starting assembly, verify all parts are included and undamaged. If any parts are missing or damaged, do not return the damaged item to your dealer; contact Customer Service. Never use damaged parts or previously used parts!

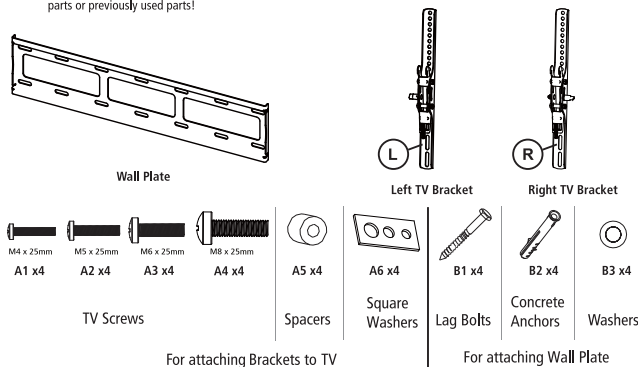

3

## Select TV Screws

- Hand thread screws into the threaded inserts on the back your TV to determine which Screw diameter to use.
- Determine whether your TV has a flat back or an irregular or obstructed back.

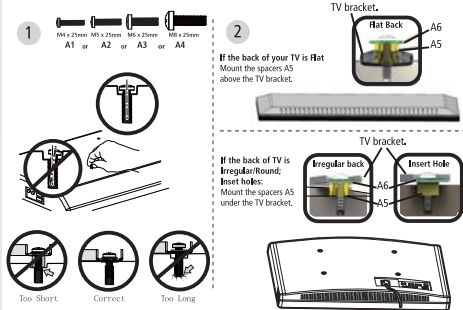

4

## Step 1: Attach TV Bracket

- Position your TV bracket over your TV hole pattern, making sure the brackets are vertically centered and level.

**Caution:** Hand tighten with screwdriver only. Do not use a power tool for this step! over tightening may damage the TV!

TV with Flat Back

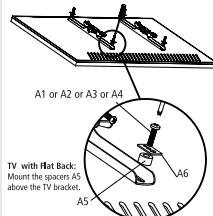

**Caution:** If you are unable to line up the hardware with the TV, please call: 1-855-816-6868

TV with Irregular/Round back; Inset holes:

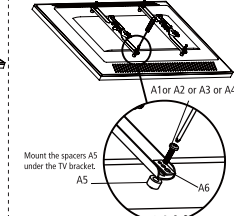

Tools Required:  
Screwdriver

5

## Step 2A: Install Wall Plate on Drywall with Wood Stud

Note: For Concrete skip to Step 2B

- Use the stud finder to locate 2 studs, and then draw a vertical line on the center of each stud.
- Level wall plate and align at center of studs. Make 4 pencil marks to indicate where to drill.

Tools Required:  
Pencil Level Stud Finder

6

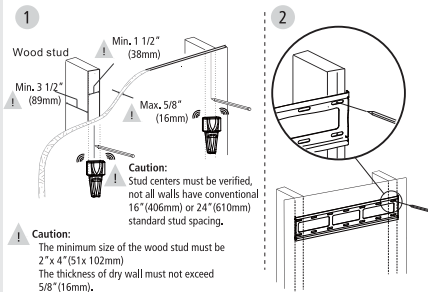

## Step 2B: Install Wall Plate on Concrete

- Level the wall plate and make 4 marks with pencil to show where to drill the pilot holes.
- Remove the wall plate and drill the pilot holes with a 3/8" drill bit.

Tools Required:  
Pencil Level Drill  
3/8" Drill Bit

8

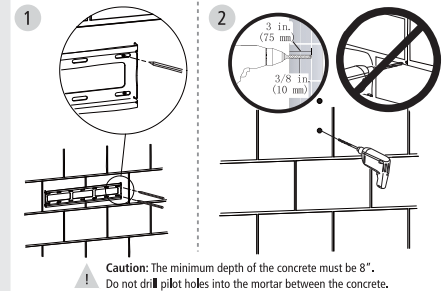

9

## Step 3: Hang our TV

**Warning:** TV should always be lifted by 2 people.

- To hang your TV, clip the TV Rails to the mounted wall plate.
- After the TV is hanging properly on the wall mount, press on the bottom of the TV to lock it in place.
- Fasten 2 screws to screw the bracket.

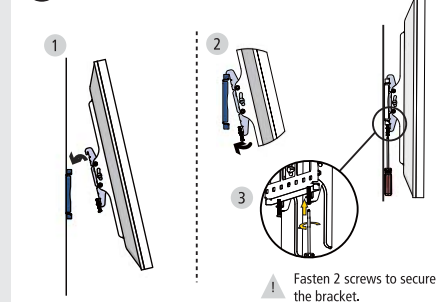

7