



15.6" WIDESCREEN LED TV

MODEL NO.: SC-1511WHT



USER MANUAL

Please read this manual carefully before using,
and keep it for future reference.

IMPORTANT INSTRUCTIONS

SAFETY INSTRUCTIONS



WARNING – TO REDUCE THE RISK OF FIRE, ELECTRIC SHOCK, OR SERIOUS PERSONAL INJURY:

- This product shall not be exposed to dripping or splashing and that no objects filled with liquids, such as vases, shall be placed on the apparatus.
- Situate this product away from heat sources such as radiators, heat registers, stoves, or other appliances (including amplifiers) that produce heat.
- Clean the product only as recommended by the manufacturer (see “Maintenance” section for details). Unplug the power adaptor from the wall outlet before cleaning,
- Unplug the power adaptor from the wall outlet when left unused for an extended period.
- Prevent objects/liquids from falling or spilled on the product.
- Operate the product only with the supplied power adaptor. Route power cords so they are not likely to be walked on or pinched by items placed upon or against them, paying particular attention to plugs, convenience receptacles, and the point where they exit from the product.
- Where the MAINS plug or an appliance coupler is used as the disconnect device, the disconnect device shall remain readily operable.
- Do not operate this product under the following conditions.
 - When the power-supply cord or plug is damaged.
 - If liquid has been spilled into or objects have fallen into the product.
 - If the product has been exposed to rain or water.
 - If the product does not operate when used according to the operating instructions.
 - If the product has been dropped or damaged in any way.
- Do not attempt to service the product; take it to the electronics repair shop of your choice for any servicing or repair.
- Do not overload wall outlets, extension cords, or integral convenience receptacles.

- Connect this product to the power outlet which has protective earth connection.



CAUTION- TO REDUCE THE RISK OR PERSONAL INJURY OR PRODUCT/PROPERTY DAMAGE:

- This product is intended solely for non-commercial, non-industrial, personal use as a television. Do not use this product for any other purpose.
- Do not subject the product to violent shocks, extreme temperatures, or lengthy periods of direct sunlight.
- Keep the product away from magnetic objects, motors, and transformers.
- Do not use outdoors in inclement weather.
- Do not use the TV while driving; this is dangerous and is illegal in some areas.



At full volume, prolonged listening to the portable audio device may damage the user’s hearing.

BATTERY HANDLING AND USAGE:

- Keep batteries away from children and pets. Only adults should handle batteries.
- Never throw batteries into a fire or expose them to fire or other heat sources.
- Follow the battery safety and usage instructions.

ACCESSORIES

User Manual.....	1
Remote Control.....	1
AC Adaptor.....	1

All the pictures in this manual are just for your reference, appearance and display should subject to the final product.

TABLE OF CONTENTS

GETTING STARTED

IMPORTANT INSTRUCTIONS.....	1-2
ACCESSORIES.....	2
FEATURES.....	4
GENERAL PARTS.....	5-6
REMOTE CONTROL.....	7-8
REMOTE CONTROL PREPARATION.....	9
BASIC CONNECTION.....	10-14

OPERATIONS

BASIC OPERATIONS.....	15-18
MAIN MENU.....	19-27
TV MODE.....	19-26
AV AND OTHER MODES.....	26
PC/VGA MODE.....	27

FOR REFERENCE

WALL MOUNTING.....	28
STAND INSTALLATION.....	29
MAINTENANCE.....	30
SPECIFICATIONS.....	30
TROUBLESHOOTING.....	31

FEATURES

15.6" LED DISPLAY

This player has a built-in LED display to provide clear vision and low radiation.

Support auto program scanning

Support digital broadcasting reception

Support Electronic Program Guide

Compatible with USB for music and photo playback

Support multi-languages on screen display

Support full function remote control

Compatible with HDMI, PC AUDIO, VGA, YPbPr, CVBS and AUDIO R/L input

Compatible with EARPHONE and COAXIAL output

With external antenna jack

With built-in speakers

GENERAL PARTS

MAIN UNIT

Front View

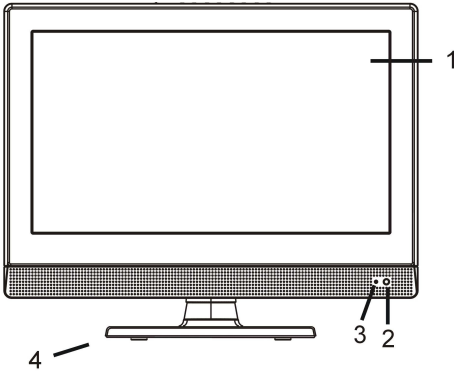

1. LED display screen
2. Remote control sensor
3. Power indicator- In standby mode the indicator light will display red color; when switching on the unit the indicator light will display blue color.
4. Stand holder
5. VOL +/- button- To increase/decrease the volume level or move left/right.
6. CH +/- button- To select next/previous channel or move up/down.
7. MENU button- To enter menu setting page.
8. SOURCE button- To select the input source.
9. POWER button- To turn ON/OFF the TV.

Top View

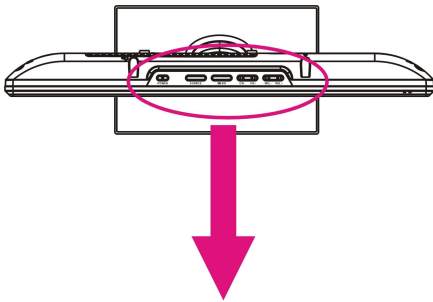

GENERAL PARTS

Back View

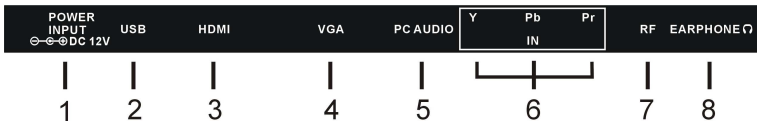
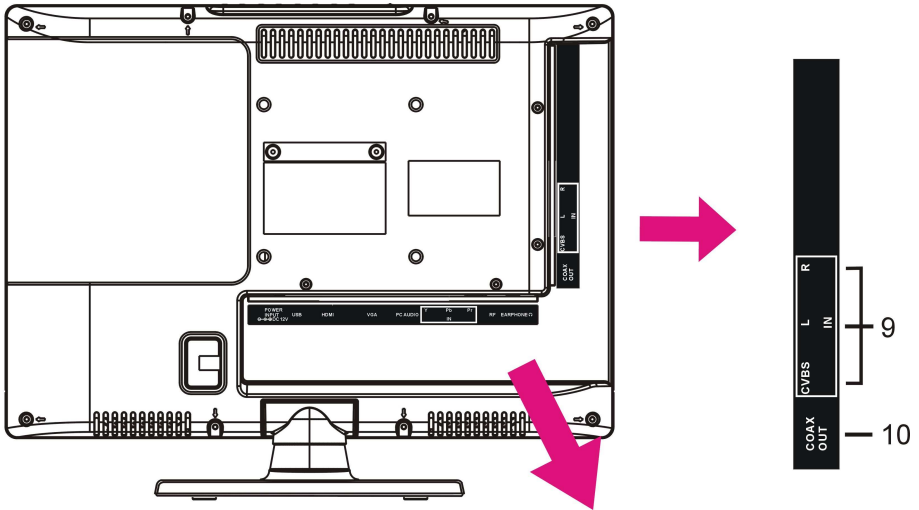

1. Power input terminal
2. USB input terminal- For MUSIC/PHOTO playback.
3. HDMI input terminal
4. VGA input terminal
5. PC AUDIO input terminal
6. YPbPr input terminals
7. RF input terminal- To connect the external antenna.
8. EARPHONE output terminal
9. CVBS and AUDIO R/L input terminals
10. COAXIAL output terminal

REMOTE CONTROL

- 1. POWER:** Pres to enable standby mode; press again to turn on.
- 2. MUTE:** To mute the sound.
- 3. Red / Green / Yellow / Blue**
- 4. NUMBER BUTTONS (0-9):** To input the number information, such as channel number and so on.
- 5. EPG:** To display electronic program guide information.
- 6. INFO:** To display current program information.
- 7. FREEZE:** To hold the picture during normal playing.
- 8. -/--:** To select additional channels (digital) being broadcast by the same station. For example, to select channel "15-3", press "1" and "5", then press "-/--" and "3".
- 9. SLEEP:** To select desired Sleep Timer.
- 10. C↻:** To return to previous channel.
- 11. SOURCE:** To switch the input source.
- 12. ASPECT:** To select desired displaying mode.
- 13. OK:** To confirm a selection.
- 14. Navigation buttons:** Press ▲/▼/◀/▶ buttons to move up/down/left/right.
- 15. MENU:** To display the main menu. Press it again to return to previous menu page.
- 16. EXIT:** To exit menu page.
- 17. PICTURE:** To switch the picture mode.
- 18. VOL +/-:** Press VOL+ button to increase the volume, or press VOL- button to decrease the volume.

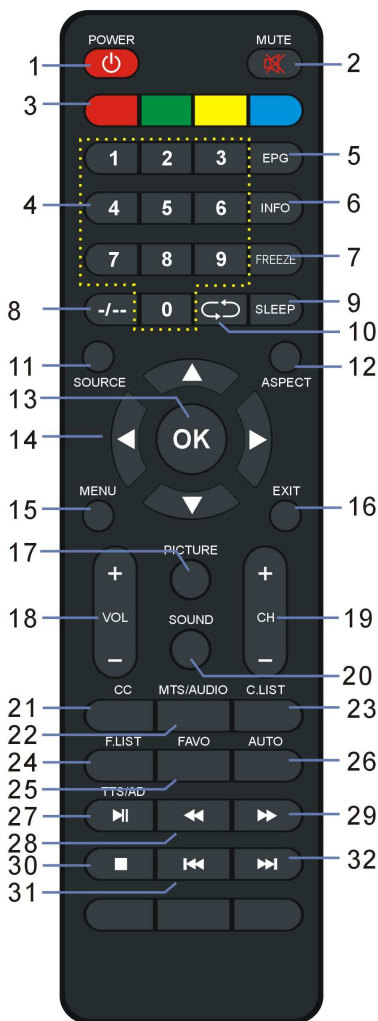

REMOTE CONTROL

19. CH+/-: Press CH+ button to play next channel, or press CH- button to play previous channel.

20. SOUND: To switch the sound mode in TV mode.

21. CC: To switch the CC mode.

22. MTS/AUDIO: To select desired soundtrack in TV mode.

23. C.LIST: To display available channels list page in TV mode.

24. F.LIST: To display the favorite channels list page in TV mode.

25. FAVO: To label current program as a favorite one or not.

26. AUTO: To adjust the screen automatically (in PC mode).

27. ⏮: Start / Pause playing;

TTS/AD: Enter TTS/AS setting page.

28. ⏪: Fast backward.

29. ⏩: Fast forward.

30. ■: Stop playing.

31. ⏮: Playing the previous file.

32. ⏩: Playing the next file.

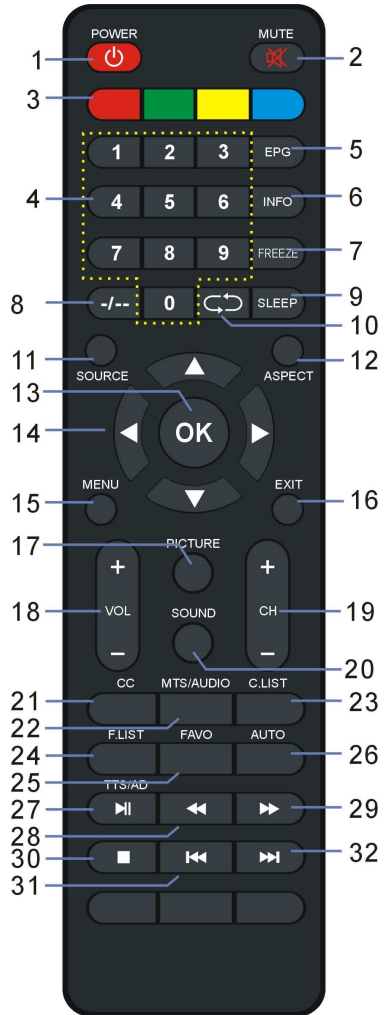

REMOTE CONTROL PREPARATION

BATTERY INSTALLATION

Install the batteries as the following pictures. Be sure + and – terminals are positioned as indicated in the battery compartment (Fig1).

SERVICE LIFE OF BATTERIES

- The batteries normally last for one year although this depends on how often the remote control is used.
- If the remote control fails to work even when it is operated near the player, replace the batteries.
- Use two size AAA dry batteries.

NOTE:

- Do not drop, step on or otherwise impact the remote control. This may damage the parts or lead to malfunction.
- If the remote control is not going to be used for a long time, remove the batteries.

REMOTE CONTROL OPERATION

Point the remote control from no more than about 6m from the remote control sensor and within about 60° of the front of the player(Fig2).

NOTES:

- The operating distance may vary according to the brightness of the room.
- Do not point bright light at remote control sensor.
- Do not place objects between the remote control and the remote control sensor.
- Do not use this remote control while simultaneously operating the remote control of any other equipments.

Fig1

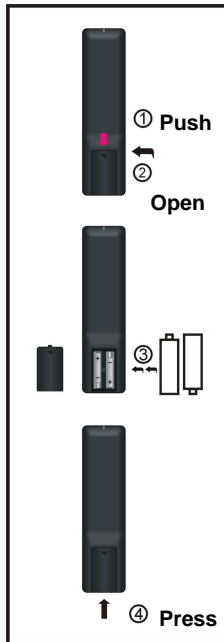
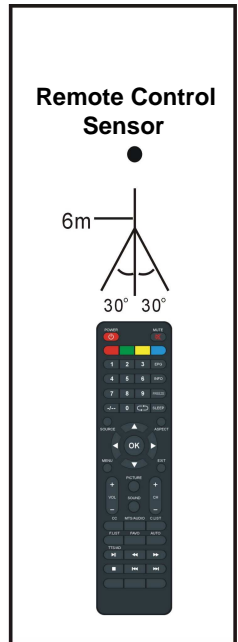

Fig2



BASIC CONNECTION

- Ensure all the cables are disconnected from the main unit before connecting to AC power source.
- Read through the instructions before connecting other equipments.

CONNECTING TO AC POWER SOURCE

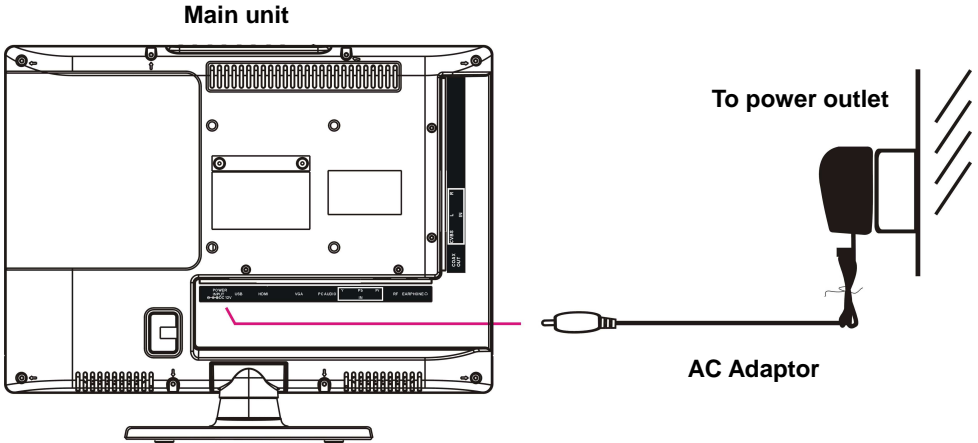

CONNECT EXTERNAL ANTENNA TO UNIT

Install external antenna into antenna jack for best picture.

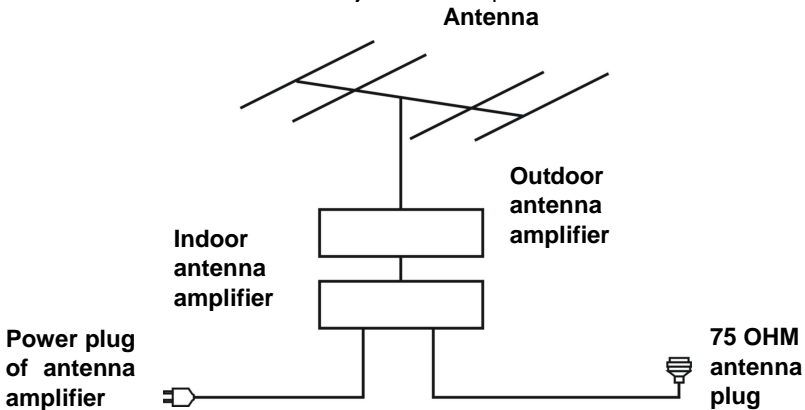

COMPOSITE AV CONNECTION



AV cable
(Optional)

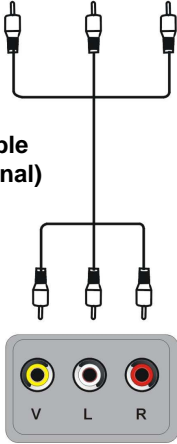

For basic connection, use the composite Audio L/R (white/red) and CVBS cable to connect the unit with other devices.

Back of DVD/VCR

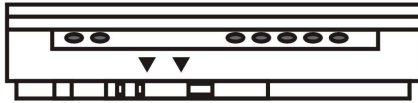

YPbPr CONNECTION



YPbPr cable
(Optional)

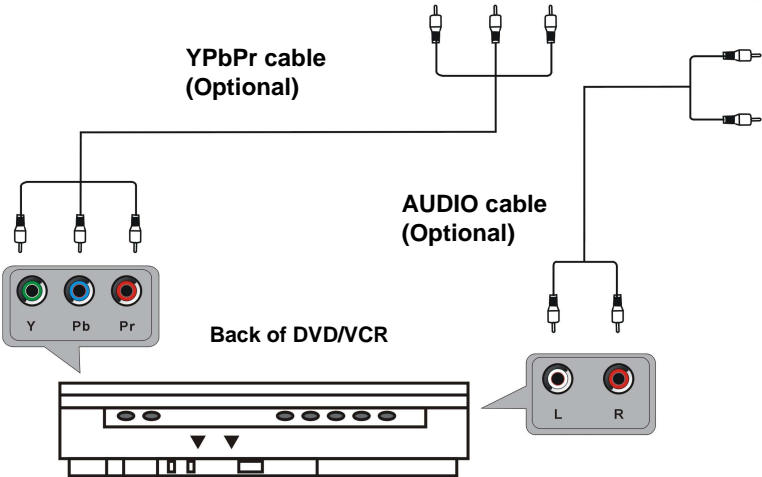

AUDIO cable
(Optional)

Back of DVD/VCR

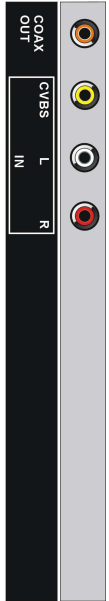

HDMI CONNECTION



**HDMI cable
(Optional)**

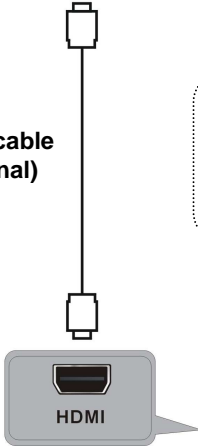

Use HDMI cable to connect the unit with other devices to receive high-definition multimedia signal.

Back of DVD/VCR

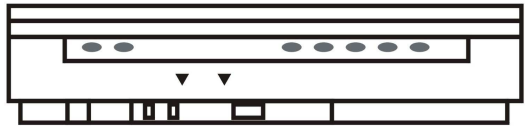

PC/VGA CONNECTION



**VGA cable
(Optional)**

**Audio cable
(Optional)**

Back of DVR or PC

Use VGA cable and Audio cable to connect the unit with TV or PC, and use this product as a monitor.

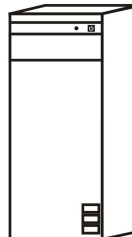
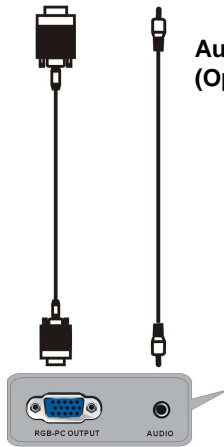

CONNECTING TO USB MEMORY DEVICE

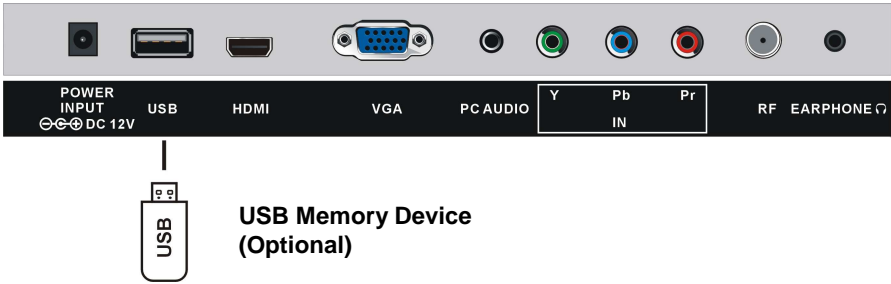

COAXIAL OUT CONNECTION

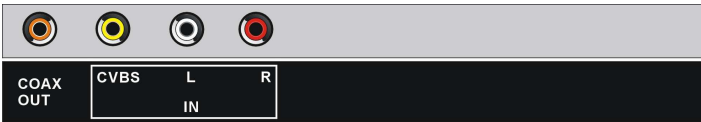

Use coaxial cable to connect the unit with amplifier or other audio decoding devices for coaxial audio signal output.

EARPHONE CONNECTION

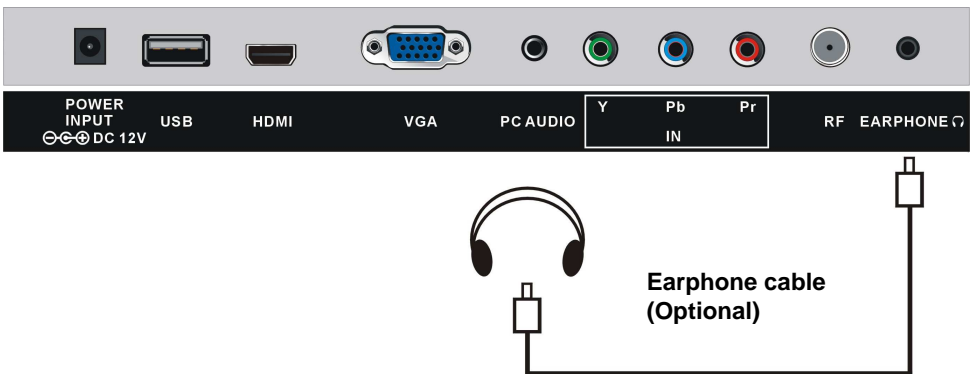

If you have your TV connected with a Cable box or Satellite Receiver box any other Video Input source you don't need to run a channel scan, please follow the procedure below to see the input source.

1. Power on TV and press "SOURCE" button on TV Remote.
2. Press UP/DOWN navigation button on TV Remote to select AV or HDMI input source and press OK button to enter it.

How to change "Input Source" signal

1. Power on TV and press "SOURCE" button on TV Remote.



2. Press DOWN arrow key and select

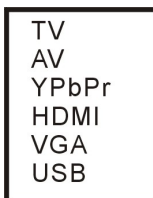

3. Press OK button on TV Remote



input source will show on TV.

MAKE SURE ALL THE EQUIPMENTS AND POWER ADAPTOR ARE CONNECTED PROPERLY AND THE UNIT IS SET IN CORRECT MODE BEFORE OPERATING.

BASIC OPERATIONS

- Press **POWER** button on the unit or remote control to power **ON** the unit (indicator will glow blue); press it again to power **OFF** (standby mode) the unit (indicator will glow red).
- Press **SOURCE** button on the unit or remote control to switch the unit to **TV mode**.

SELECT DESIRED PROGRAM

1. Press **CH+** button to play next channel.
2. Press **CH-** button to play previous channel.
3. Press number buttons on the remote control directly to select desired program.
Example : Track 9, press " 9 " , three seconds later it will turn to track 9 automatically, or press **OK** button to confirm directly.
Track 12, press " 1 " and " 2 " , three seconds later it will turn to track 12 automatically, or press **OK** button to confirm directly.

NOTE : If one frequency dot has more than one channel, for example, track 15-3, press " 1 " and " 5 " , then press " -/-- " and " 3 " , three seconds later it will turn to track 15-3 automatically, or press **OK** button to confirm directly.

VOLUME CONTROL

- Press **VOL+** or **VOL-** to adjust the level of current volume.
Available range: 0-100.

MUTE CONTROL

- Press **MUTE** button to mute the sound, press it again to turn on the sound.

SOURCE SETTING

- Press **SOURCE** button on remote control to display the sources list.
- Press **UP** or **DOWN** navigation button to select desired input source, then press **OK** button to confirm selection.
- Or press **SOURCE** button on the unit repeatedly to select desired input source.

PICTURE MODE

- Press **PICTURE** button on remote control repeatedly to select desired picture mode.
Available options: User, Standard, Dynamic, Mild.

SOUND MODE

- Press SOUND button on remote control repeatedly to select desired sound mode.
Available options: User, Music, Movie, Standard.

CLOSED CAPTION

- Press CC button on remote control repeatedly to set the CLOSED CAPTION function On or Off.

SLEEP TIMER SETTING

- Press SLEEP button on remote control repeatedly to select desired sleep time.
Available options: Off, 5 min, 10 min, 15 min, 30 min, 45 min, 60 min, 90 min, 120 min, 180 min, 240 min.

VIDEO SIZE SETTING

- Press ASPECT button on remote control repeatedly to select desired video size
Available options: Normal, Wide, Zoom, Cinema.

MTS/AUDIO SETTING

- Press MTS/AUDIO button on remote control to enter Sound menu page, then use UP or DOWN navigation button to select desired option. Options: Mono, Stereo, SAP.
(Not available in all channels)
- Or press MTS/AUDIO button on remote control to display Digital Sound language.
(Not available in all channels)

INFORMATION DISPLAY

- Press INFO button on remote control to display information of current program.

EPG (ELECTRONIC PROGRAM GUIDE)

- Press EPG button on remote control to enter into Electronic Program Guide menu page.
(Not available in all channels)
- Press LEFT or RIGHT navigation button to view previous or next page.

FAVOURITE LIST

- Press F.LIST button on remote control to enter FAVORITE LIST menu page.
- Press UP/DOWN navigation button to select desired channel.
- Press OK button to confirm selection.

NOTE: During normal playing, press FAVO button on remote control to label current program as a favorite one or not.

CHANNEL LIST

- Press C.LIST button on remote control to enter CHANNEL LIST menu page.
- Press UP/DOWN navigation button to select desired channel.
- Press OK button to confirm selection.

FREEZE FUNCTION

- During normal playing, press FREEZE button on remote control to hold the picture, and press it again to resume normal playing.

USB OPERATION

- Before following operations, insert a USB memory device first, which contains Photo and Music files.

- Press SOURCE button on the unit or remote control to set the unit in USB mode.

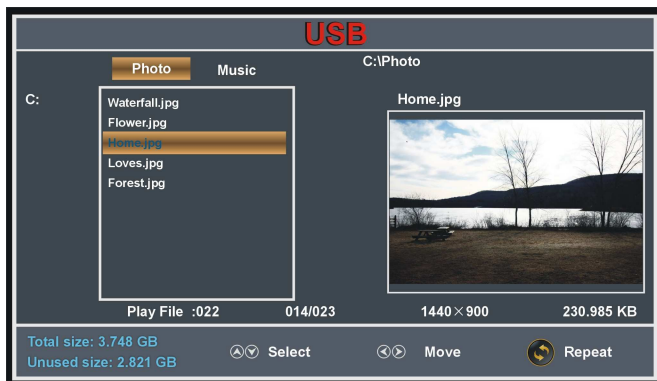

- Press LEFT/RIGHT navigation button to select Photo/Music in the main menu.

- Press UP/DOWN navigation button to select preferred file.

Photo Playback

- Select Photo item in the main menu.

- Press UP/DOWN navigation button to select preferred folder/file and press OK button to enter a folder or play selected file.

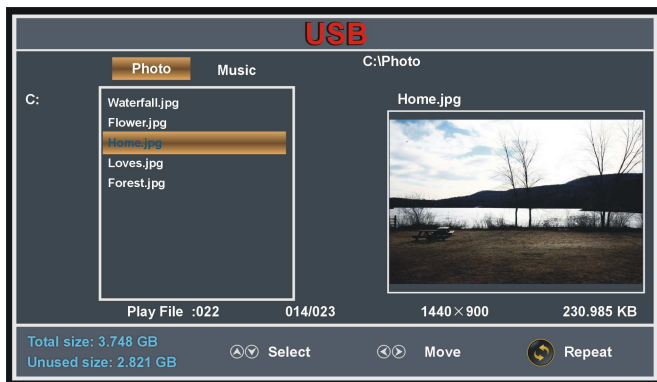

During normal playing:

- Press UP/DOWN navigation button to play previous/next photo.
- Press LEFT/RIGHT navigation button to rotate a photo counterclockwise/clockwise.
- Press EXIT button to return to file selecting page.

Music Playback

- Select Music item in the main menu.
- Press UP/DOWN navigation button to select preferred folder/file and press OK button to enter a folder or play selected file.



During normal playing:

- Press INFO button to display/hide the tool bar.



- Press LEFT/RIGHT navigation button to select preferred option and press OK button to confirm it.

MAIN MENU

- The unit contains different setting menus. Once the initial programming is entered, it will be remained in the memory until change, and the unit can always be operated under the same conditions.
- The settings will be remained in the memory until the settings are changed, even after setting the player to standby mode.

Common procedure for initial settings

- Press MENU button on the unit or remote control to display the main menu.
- Press LEFT or RIGHT navigation button to select Picture/Audio/Time/Setup/Channel.
- Press DOWN navigation button to enter submenu page.
- Press UP or DOWN navigation button to select the option that want to adjust.
- Press LEFT or RIGHT navigation button to adjust selected option to desired value.
- Press RIGHT navigation button or OK button to enter next menu page.
- Press MENU button to return to previous menu page.
- Press EXIT button to exit menu page.

TV MODE

- If this is your first time turning on this TV, Setup Wizard will appear on the screen.

- Press UP or DOWN navigation button to select preferred item.

- Press LEFT or RIGHT navigation button to adjust the value.

Menu Language

Choose your menu language.

Air/Cable

To choose your signal type: Air, Cable.

Cable System

To choose your Cable System: AUTO, STD, IRC, HRC.

NOTE: Cable System is adjustable only when your signal type is set to Cable.

Auto Scan

Highlight Auto Scan, press OK to search and store all available channels.



1. PICTURE



1.1 Picture Mode

Available options: User, Standard, Dynamic, Mild.

1.2 Contrast

The value of Contrast can be adjusted from 0-100.

1.3 Brightness

The value of Brightness can be adjusted from 0-100.

1.4 Color

The value of Color can be adjusted from 0-100.

1.5 Tint

The value of Tint can be adjusted from -50 to 50.

NOTE: Tint is adjustable only in certain TV system.

1.6 Sharpness

The value of Sharpness can be adjusted from 0-100.

NOTE: If the value of Contrast, Brightness, Color, Tint or Sharpness has been changed, the picture mode will turn to User automatically.

1.7 Color Temp. (Color Temperature)

Available options: Normal, Warm, Cool.

2. AUDIO



2.1 Sound Mode

Available options: User, Music, Movie, Standard.

2.2 Bass

The value of Bass can be adjusted from 0-100.

2.3 Treble

The value of Treble can be adjusted from 0-100.

2.4 Balance

The value of Balance can be adjusted from -50 to 50.

NOTE: If the value of Bass or Treble has been changed, the sound mode will turn to User automatically.

2.5 Surround

This item is used to turn on/off Sound Surround function.

2.6 AVC (Auto Volume Control)

Available options: On, Off.

2.7 SPDIF Type

This item is used to select preferred SPDIF audio output type.

Available options: RAW, PCM.

2.8 Audio Language

This item is used to select preferred audio language.

NOTE: This item is adjustable only for digital programs.

2.9 Accessibility

This item is used to make accessibility for people who are blind or visually impaired.

Voice Guide

Turn on/off Voice Guide for some texts on screen.

Voice Guide: On, Off

Volume: Weak, Middle, Strong.

Speed: Weak, Middle, Strong.

Pitch: Weak, Middle, Strong.

Video Description

Turn on/off Video Description

3. TIME

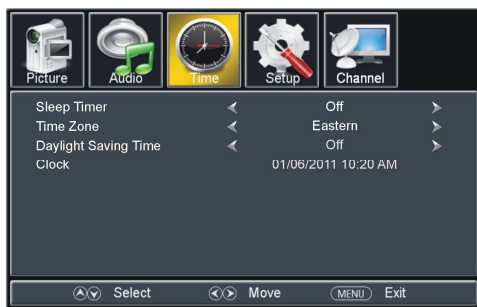

3.1 Sleep Timer

Available options: Off, 5 min, 10 min, 15 min, 30 min, 45 min, 60 min, 90 min, 120 min, 180 min, 240 min.

3.2 Time Zone

Available options: Eastern, Central, Mountain, Pacific, Alaska, Hawaii, Atlantic.

3.3 Daylight Saving Time

Available options: On, Off.

NOTE: This item is adjustable only for digital programs.

3.4 Clock

When an available digital program is present, this unit will get Date and Time information automatically from current program. And it's not user adjustable.

4. SETUP



4.1 Menu Language

This item is used to select preferred OSD menu language.

4.2 Transparency

This item is used to turn on/off Transparent OSD menu.

4.3 Zoom Mode

This item is used to select preferred zoom mode of display screen.

Available options: Normal, Wide, Zoom, Cinema.

NOTE: The available zoom mode may be different for different input source.

4.4 Noise Reduction

Available options: Off, Weak, Middle, Strong.

4.5 Advanced

This item is adjustable only for PC/VGA input signal.

4.6 Closed Caption

4.61 CC Mode

Available options: CC on Mute, Off, On.

4.62 Basic Selection

Available options: CC1, CC2, CC3, CC4, Text1, Text2, Text3, Text4.

4.63 Advanced Selection

Available options: Service1, Service2, Service3, Service4, Service5, Service6.

4.64 Option

Mode

Available options: Default, Custom.

Font Style

Available options: Default, Font 0, Font 1, Font 2, Font 3, Font 4, Font 5, Font 6, Font 7.

Font Size

Available options: Default, Normal, Large, Small.

Font Edge Style

Available options: Default, None, Raised, Depressed, Uniform, Left Shadow, Right Shadow.

Font Edge Color

Available options: Default, Black, White, Red, Green, Blue, Yellow, Magenta, Cyan.

FG Color

Available options: Default, White, Red, Green, Blue, Yellow, Magenta, Cyan.

BG Color

Available options: Default, Black, Red, Green, Blue, Yellow, Magenta, Cyan.

FG Opacity

Available options: Default, Solid, Flashing, Translucent, Transparent.

BG Opacity

Available options: Default, Solid, Flashing, Translucent, Transparent.

4.7 DLC

This item is used to turn on/off Dynamic Luminance Control.

4.8 OverScan (HDMI mode only)

Turn on OverScan if users can not get full screen display in HDMI mode.

4.9 Restore Default

This item is used to reset to factory default settings.

5. CHANNEL



5.1 Air/Cable

This item is used to select preferred signal receiving type.

5.2 Auto Scan

-Press RIGHT or OK button to enter it.

5.21 Cable System

This item is used to select preferred cable system.

Available options: AUTO, STD, IRC, HRC.

NOTE: This item is adjustable only when your signal type is set to Cable.

5.22 Start to Scan

- Press RIGHT or OK button to start auto scanning.



- Press MENU or EXIT button to exit auto channel searching.

5.3 Favorite

- Press RIGHT or OK button to enter it.
- Press UP or DOWN navigation button to select preferred channel.
- Press OK button to label the selected channel as a favorite one or not.

5.4 Show/Hide

- Press RIGHT or OK button to enter it.
- Press UP or DOWN navigation button to select preferred channel.
- Press OK button to show or hide the selected channel.

5.5 Channel No.

- Press LEFT or RIGHT navigation button to select preferred channel number.

5.6 Channel Label

- Press RIGHT or OK button to enter it.
- Press LEFT or RIGHT navigation button to move the cursor.
- Press UP or DOWN navigation button to adjust the value.

NOTE: If no available channel is present, Favorite, Show/Hide, Channel No., and Channel Label will not be adjustable.

5.7 DTV Signal

This item is not user adjustable.

AV AND OTHER MODES

- Press SOURCE button on the unit or remote control to select desired input source.
- For PICTURE, AUDIO, TIME and SETUP menus, please refer to the menu operations of TV mode.

PC/VGA MODE

- Press SOURCE button on the unit or remote control to set the unit in VGA mode.
- Press MENU button to display the main menu and select Setup item. Then press DOWN navigation button to enter Setup menu page.
- Press UP or DOWN navigation button to select Advanced and press RIGHT navigation button or OK button to enter it.



1. H-Pos (Horizontal Position)

Available range: 0-100.

2. V-Pos (Vertical Position)

Available range: 0-100.

3. Clock

Available range: 0-100.

4. Phase

Available range: 0-100.

5. Auto

If this item is entered, it will adjust the PC screen automatically.

WALL MOUNTING

WARNING:

- Contact a professional for assistance when wall mounting your TV. We are not responsible for any damage to the product or injury to yourself, if you mount the TV on your own.
- Do not wall mount the TV while TV is turned on or connected to power. It may cause personal injury due to electric shock.
- Use standard M4*8mm screws (4 pieces; not included) to mount this TV.

Back of your TV

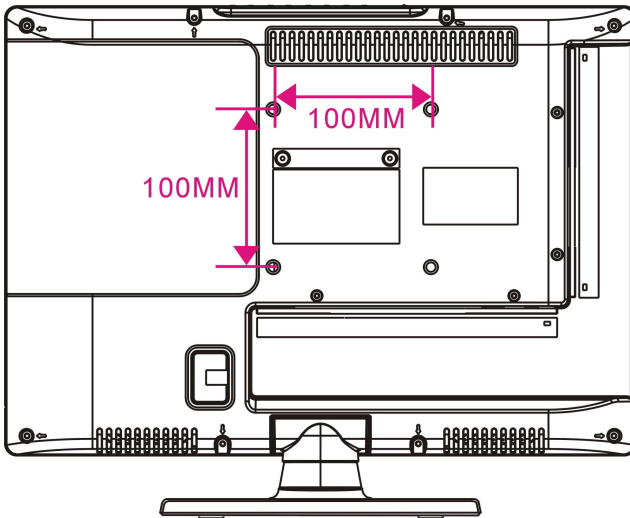

STAND INSTALLATION

Your TV may be packaged with the Stand and the Cabinet separated. Before enjoying this TV, please carry out the Stand Installation according to the instructions below.

Step 1

Place the TV faced down on a soft cloth or cushion to prevent the panel from being damaged.

Step 2

Align the stand and the bottom of this TV.

Step 3

Tighten the included screws with a screw driver.

NOTES:

- Unplug the power plug first when installing or removing the TV Stand.
- To avoid any damage to this TV, contact one or more partner for assistance when installing or removing the TV stand.

To: remove the Stand Support:

Open the Front Cover and disassemble the screws which used to lock Stand Support and Back Cover.

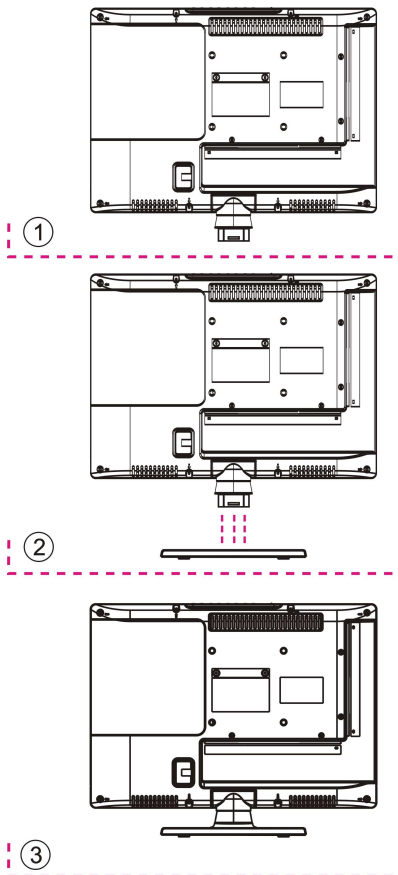

MAINTENANCE

- Be sure to press POWER button to set the player to the standby mode and disconnect the power plug before maintaining the player.
- Wipe the player with a dry, soft cloth.
- If the surface is extremely dirty, wipe clean with a cloth which has been dipped in a weak soap-water solution and wrung out thoroughly, and then wipe again with a dry cloth.
- Never use alcohol, benzene, thinner, cleaning fluid or other chemicals. And do not use compressed air to remove dust.

SPECIFICATIONS

Display Device	15.6 inch LED TV	
Resolution	1366×768	
Display Colors	262 K	
Contrast Ratio	500:1	
Aspect Ratio	16:9	
Life Time	10,000 Hrs	
Signal Format Supported	PC-RGB	Up to 1366×768@60Hz
	HDMI	Max. 1080P
	Component	Max. 1080P
Power Source	AC adaptor(normal DC 12 V $\overline{\text{---}}$ 1.5A)	
Power Consumption	<18W	
Operation Temperature	-5°C to 45°C	
Measurement	400(W)×119(D)×325(H) mm	
Weight	Approx. 1.1 Kg	

Specifications are subject to change without notice.

GENERAL TROUBLESHOOTING

Check the following points before assuming malfunctions of this unit:

Symptom	Remedy
No power.	Insert the power plug securely into the power outlet.
No picture.	Ensure that the equipment is connected properly.
<ul style="list-style-type: none"> ● No sound. ● Distorted sound. 	<ul style="list-style-type: none"> ● Ensure that the equipment is connected properly. ● Ensure that the input setting for the TV and stereo system are correct. ● Adjust the master volume to a suitable volume by pressing VOL+/VOL- button.
No operations can be performed with the remote control unit.	<ul style="list-style-type: none"> ● Check if the batteries are installed with the correct polarities. ● The batteries are exhausted: replace them with new ones. ● Point remote control at the remote sensor on TV and operate it again. ● Operate the remote control unit at a distance of less than 6m from the remote control sensor on TV. ● Remove the obstacles between the remote control and remote control sensor on TV.
No key operation (by the main unit and/or the remote control unit) is effective.	Disconnect the power adaptor from power source and then reconnect it. (This TV may not be operating properly due to lightning, static electricity or some other factors.)
Symptom(TV)	Remedy
No or poor picture.	<ul style="list-style-type: none"> ● Adjust antenna or use an external antenna. ● Relocate the unit near a window (if inside a building). ● Move subjects that cause interference away from this TV. ● Do Auto Tuning again. ● Try another channel.
No sound or poor sound.	<ul style="list-style-type: none"> ● Check the audio settings. ● Press MUTE button on remote control to cancel mute function. ● Unplug the headphone.
Noise or other interference	Electronic equipment near the unit is causing interference. Relocate the unit or move the equipment.

Warranty

Basic Warranty Statement

Supersonic Inc. ("Supersonic") warrants this product to the original purchaser ONLY, to be free from defects in materials and workmanship under normal use, for ninety (90) DAYS from the date of original purchase. Proof of purchase (receipt) required.

Please visit <http://www.supersonicinc.com/warranty> for additional information.