

Clock Radio with Wireless Charging



**MODEL: QiCR-200
USER MANUAL**

**PLEASE READ THIS USER MANUAL COMPLETELY BEFORE OPERATING
THIS UNIT AND RETAIN THIS BOOKLET FOR FUTURE REFERENCE**

WARNING

TO PREVENT FIRE OR SHOCK HAZARD, DO NOT USE THIS PLUG WITH AN EXTENSION CORD, RECEPTACLE OR OTHER OUTLET UNLESS THE BLADES CAN BE FULLY INSERTED TO PREVENT BLADE EXPOSURE. TO PREVENT FIRE OR SHOCK HAZARD, DO NOT EXPOSE THIS APPLIANCE TO RAIN OR MOISTURE.

 <p>The lightning flash with arrowhead symbol, within an equilateral triangle is intended to alert the user to the presence of uninsulated dangerous voltage within the product is enclosure that may be of sufficient magnitude to constitute a risk of electric shock to persons.</p>	<table border="1"><tr><td>CAUTION</td></tr><tr><td>RISK OF ELECTRIC SHOCK</td></tr><tr><td>DO NOT OPEN</td></tr></table> <p>CAUTION TO REDUCE THE RISK OF ELECTRIC SHOCK, DO NOT REMOVE COVER (OR BACK). NO USER-SERVICEABLE PARTS INSIDE. REFER SERVICING TO QUALIFIED SERVICE PERSONEL.</p>	CAUTION	RISK OF ELECTRIC SHOCK	DO NOT OPEN	 <p>The exclamation point within an equilateral triangle is intended to alert the user to the presence of important operating and maintenance (servicing) instructions in the literature accompanying the appliance.</p>
CAUTION					
RISK OF ELECTRIC SHOCK					
DO NOT OPEN					

The Rating plate is located at the back enclosure of the apparatus

IMPORTANT SAFETY INSTRUCTIONS

1. Read these instructions.
2. Keep these instructions.
3. Heed all warnings.
4. Follow all instructions.
5. Do not use this apparatus near water.
6. Clean only with dry cloth.
7. Do not block any ventilation openings. Install in accordance with the manufacturer's instructions.
8. Do not install near any heat sources such as radiators, heat registers, stoves, or other apparatus (including amplifiers) that product heat.
9. AC adaptor is used as disconnect device and it should remain readily operable during intended use. In order to disconnect the apparatus from the mains completely, the AC adaptor should be disconnected form the mains socket outlet completely.
10. Only use attachments/accessories specified by the manufacturer.
11. Use only with a cart, stand, tripod, bracket, or table recommended by the manufacturer, or sold with the product.
When a cart is used, use caution when moving the cart/apparatus combination to avoid injury from tip-over.
12. Unplug this apparatus during lightning storms or when unused for a long periods of time.
13. Refer all servicing to qualified service personnel. Servicing is required when the apparatus has been damaged in any way, such as power-supply cord or plug is damaged, liquid has been spilled or objects have fallen into the apparatus, the apparatus has been exposed to rain or moisture, does not operate normally, or has been dropped.
14. This appliance shall not be exposed to dripping or splashing water and that no object filled with liquids such as vases shall be placed on the apparatus.
15. Do not overload wall outlet. Use only power source as indicated.
16. Use replacement part as specified by the manufacturer.



17. Upon completion of any service or repairs to this product, ask the service technician to perform safety checks.
18. Power Sources - This product should be operated only from the type of power source indicated on the marking label. If you are not sure of the type of power supply to your home, consult your product dealer or local power company. For products intended to operate from battery power, or other sources, refer to the operating instruction.
19. Object and Liquid Entry - Never push objects of any kind into this product through openings as they may touch dangerous voltage points or short-out parts that could result in a fire or electric shock. Never spill liquid of any kind on the product.
20. Damage Requiring Service - Unplug this product from the wall outlet and refer servicing to qualified service personnel under the following conditions:
 - a) When the power-supply cord or plug is damaged,
 - b) If liquid has been spilled, or objects have fallen into the product,
 - c) If the product has been exposed to rain or water,
 - d) If the product does not operate normally by following the operating instructions. Adjust only those controls that are covered by the operating instructions as an improper adjustment of other controls may result in damage and will often require extensive work by a qualified technician to restore the product to its normal operation.
 - e) If the product has been dropped or damaged in any way, and
 - f) When the product exhibits a distinct change in performance - this indicates a need for service.
21. Battery shall not be exposed to excessive heat such as sunshine, fire or the like.
22. Minimum distances of 10 cm around the apparatus for sufficient ventilation.
23. The ventilation should not be impeded by covering the ventilation openings with items, such as newspapers, table-cloths, curtains, etc.
24. No naked flame sources, such as lighted candles, should be placed on the apparatus.
25. The use of apparatus in moderate climates.
26. Attention should be drawn to the environmental aspects of battery disposal

SAVE THESE INSTRUCTIONS

COMPLIANCE WITH FCC REGULATIONS

FCC ID 2APXVCQ2

This device complies with Part 15 of the FCC Rules. Operation is subject to the following two conditions:

- (1) This device may not cause harmful interference, and
- (2) This device must accept any interference received, including interference that may cause undesired operation.

This equipment has been tested and found to comply with the limits for a class B digital device, pursuant to Part 15 of the FCC Rules. These limits are designed to provide reasonable protection against harmful interference in a residential installation. This equipment generates uses and can radiate radio frequency energy and, if not installed and used in accordance with the instructions, may cause harmful interference to radio communications. However, there is no guarantee that interference will not occur in a particular installation. If this equipment does cause harmful interference to radio or television reception, which can be determined by turning the equipment off and on, the user is encouraged to try to correct the interference by one or more of the following measures:

- Reorient or relocate the receiving antenna.
- Increase the separation between the equipment and receiver.
- Connect the equipment into an outlet on a circuit different from that to which the receiver is connected.
- Consult the dealer or an experienced radio/TV technician for help.

CAUTION: Changes or modifications not expressly approved by the party responsible for compliance could void the user's authority to operate the equipment.

PROTECT YOUR FURNITURE!!

This system is equipped with non-skid rubber 'feet' to prevent the product from moving when you operate the controls. These 'feet' are made from non-migrating rubber material specially formulated to avoid leaving any marks or stains on your furniture. However certain types of oil based furniture polishes, wood preservatives, or cleaning sprays may cause the rubber 'feet' to soften and leave marks or a rubber residue on the furniture.

To prevent any damage to your furniture we strongly recommend that you purchase small self-adhesive felt pads, available at hardware stores and home improvement centers everywhere, and apply these pads to the bottom of the rubber 'feet' before you place the product on fine wooden furniture.

DEAR JENSEN CUSTOMER

Selecting fine audio equipment such as the unit you've just purchased is only the start of your musical enjoyment. Now it's time to consider how you can maximize the fun and excitement your equipment offers. This manufacturer and the Electronic Industries Association's Consumer Electronics Group want you to get the most out of your equipment by playing it at a safe level. One that lets the sound come through loud and clear without annoying blaring or distortion and, most importantly, without affecting your sensitive hearing.

Sound can be deceiving. Over time your hearing "comfort level" adapts to higher volumes of sound. So what sounds "normal" can actually be loud and harmful to your hearing. Guard against this by setting your equipment at a safe level BEFORE your hearing adapts.

To establish a safe level:

- Start your volume control at a low setting.
- Slowly increase the sound until you can hear it comfortably and clearly, and without distortion.

Once you have established a comfortable sound level:

- Set the dial and leave it there.

Taking a minute to do this now will help to prevent hearing damage or loss in the future. After all, we want you listening for a lifetime.

We Want You Listening For a Lifetime

Used wisely, your new sound equipment will provide a lifetime of fun and enjoyment. Since hearing damage from loud noise is often undetectable until it is too late, this manufacturer and the Electronic Industries Association's Consumer Electronics Group recommend you avoid prolonged exposure to excessive noise.



Customer's Record:

The serial number of this product is found on its bottom. You should note the serial number of this unit in the space provided as a permanent record of your purchase to aid in identification in the event of theft or loss.

Model Number: QiCR-200

Serial Number:

LOCATION OF CONTROLS

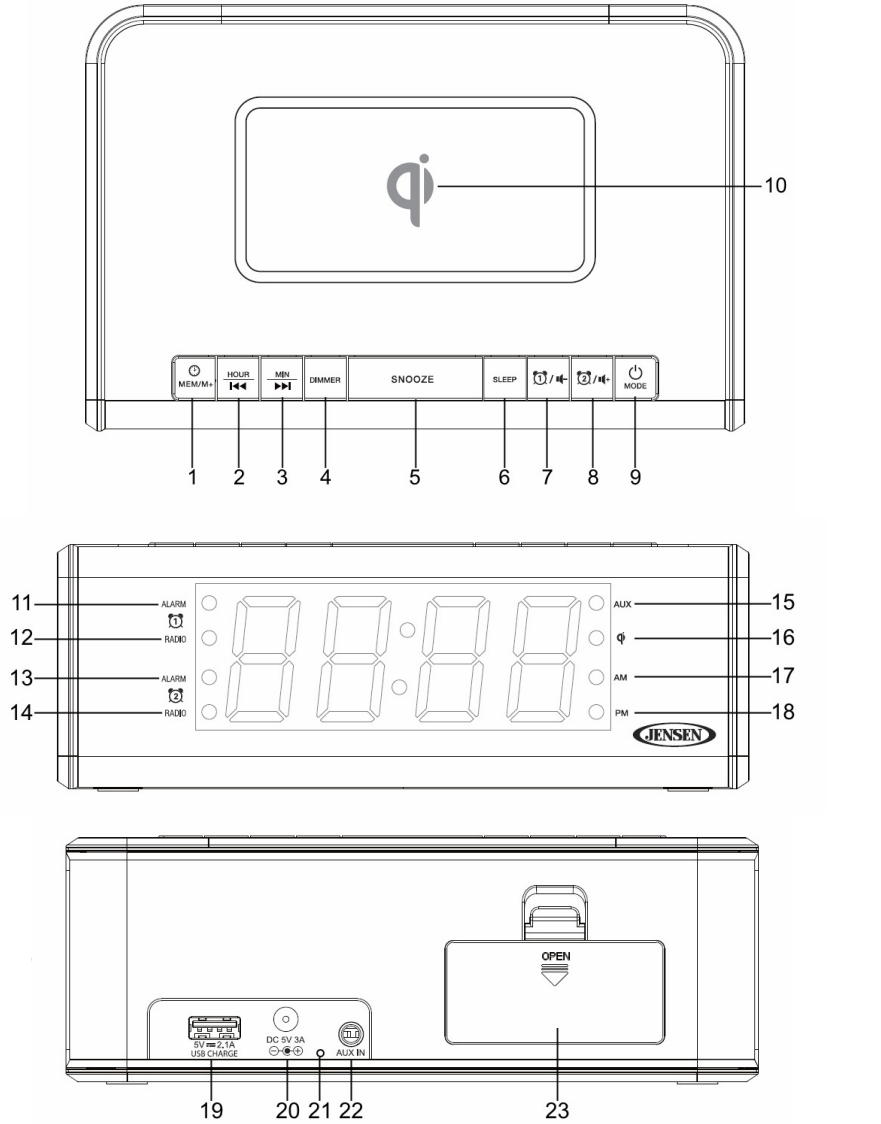

- | | |
|--|---|
| <p>1 / MEM / M + BUTTON</p> <p>2 HOUR / BUTTON</p> <p>3 MIN / BUTTON</p> <p>4 DIMMER BUTTON</p> <p>5 SNOOZE BUTTON</p> <p>6 SLEEP BUTTON</p> <p>7 / - BUTTON</p> <p>8 / + BUTTON</p> <p>9 / MODE BUTTON</p> <p>10 WIRELESS CHARGING PAD</p> <p>11 ALARM 1 INDICATOR
(wake to alarm)</p> <p>12 ALARM 1 INDICATOR
(wake to radio)</p> | <p>13 ALARM 2 INDICATOR
(wake to alarm)</p> <p>14 ALARM 2 INDICATOR
(wake to radio)</p> <p>15 AUX-IN INDICATOR</p> <p>16 CHARGING INDICATOR</p> <p>17 AM INDICATOR</p> <p>18 PM INDICATOR</p> <p>19 USB CHARGING PORT</p> <p>20 DC IN JACK</p> <p>21 FM ANTENNA</p> <p>22 AUX-IN JACK</p> <p>23 BATTERY DOOR</p> |
|--|---|

POWER SOURCE (AC ADAPTOR ONLY)

The QiCR-200 operates with an external AC-DC adaptor with output DC 5V $\overline{\text{---}}$ 3A .

The unit is also equipped with a battery back-up system for the clock that is powered by 2 x AAA batteries (Not included).

POWER CONNECTION

1. Connect the cord of the power adaptor to the DC IN JACK (#20) of the QiCR-200.
2. Connect the plug of the power adaptor to a wall socket.
The QiCR-200 is powered and in standby mode when you see the display is switched on.

Battery Back-up system

- The radio is equipped with a battery back-up system. It requires 2 x AAA batteries (Not included).
- Open the BATTERY DOOR (#23). Insert the batteries into the battery compartment and make sure the positive and negative (+ or -) sides of the batteries are in contact with the corresponding terminals in the battery compartment. Replace the BATTERY DOOR (#23).
- If a power cut occurs, the radio automatically switches to the battery power supply and keeps the clock and timer settings.
- When replacing the battery, do not disconnect the power adaptor. Otherwise, all clock and alarm settings will be lost.



CAUTIONS:

1. Do not mix old and new batteries.
2. Only use good quality/name brand batteries.
3. Do not mix alkaline, standard (carbon-zinc) or rechargeable (nickel-cadmium) batteries.
4. If the unit is not going to be used for an extended period of time, please remove the batteries. Using old, leaking or cheaply made batteries can cause damage to the unit and may void the warranty.
5. Do not dispose of batteries in fire, batteries may explode or leak.
6. Batteries shall not be exposed to excessive heat such as sunshine, fire or the like.
7. Replace all the batteries at the same time, no matter exhausted or not, every 2 years at the same time to avoid possible battery leakage.
8. Do not try to recharge batteries not intended to be recharged; they can overheat, rupture and leak. (Follow battery manufacturer's directions).
9. Only an adult should replace the batteries.

SETTING THE CLOCK TIME

In order for the clock to function properly, the clock must be set before using it for the first time. The display will be flashing when you plug the unit in for the first time. If the display is not flashing, and the unit is in standby mode, press and hold the  / MEM / M + BUTTON (#1) until the clock display begins to flash.

To set the time, follow the steps below:

1. Tap the HOUR/◀◀ BUTTON (#2) repeatedly to set the correct hour. Press and hold the button to increase the time faster.
2. After hour is set, tap the MIN/▶▶I BUTTON (#3) repeatedly to set the correct minutes. Press and hold the button to increase the time faster.
3. Press the  / MEM / M + BUTTON (#1) to confirm the time. The unit will automatically save the setting and exit the time set mode if you do not tap the  / MEM / M + BUTTON (#1) within 5 seconds.

Notes:







If the AM INDICATOR (#17) is ON, the time displayed is “AM”.

If the PM INDICATOR (#18) is ON, the displayed time is “PM”.



ALARM OPERATION

The QiCR-200 features a dual alarm clock.



To set the alarms:

1. While in standby mode, press and hold the  / - BUTTON (#7) to enter the ALARM 1 time setting mode.
2. The alarm time display will flash.
3. Tap the HOUR/◀◀ BUTTON (#2) repeatedly to set alarm hour. Press and hold the button to increase the time faster.
4. Tap the MIN/▶▶I BUTTON (#3) repeatedly to set the alarm minutes. Press and hold the button to increase the time faster.
5. Tap the  / - BUTTON (#7) to confirm.
6. Follow the same steps to set ALARM 2 using the  / + BUTTON (#8).

SETTING WAKE TO ALARM, RADIO or OFF

1. While in standby mode, tap the  / - BUTTON (#7) repeatedly to set ALARM 1.

The alarm time will show on the display.

- a. Wake to Alarm, ALARM 1 INDICATOR (wake to alarm) (#11) will light up.
 - b. Wake to Radio, ALARM 1 INDICATOR (wake to radio) (#12) will light up.
 - c. ALARM 1 Off, both WAKE to ALARM & RADIO indicators will be off.
2. Follow the same steps for ALARM 2 using the  / + BUTTON (#8).
 3. When the alarm sounds, the corresponding alarm indicators will flash.
 4. The alarm will continue to sound for one hour unless stopped by pressing the  / MODE BUTTON (#9).
 5. The set alarm times will sound again at the same time the following day.

Note: If ALARM 1 and ALARM 2 are set to the same time, only ALARM 1 will sound.

NOOZE FUNCTION











When the alarm sounds, tap the SNOOZE BUTTON (#5) to temporarily turn off the alarm and activate the snooze function, the alarm will stop and sound again 9 minutes later. If you tap the SNOOZE (#5) again, the alarm will temporarily turn off again and sound again in 9 minutes and so on. The alarm sound will turn off after one hour.

NOTES :



- To temporarily silence the alarm, press the SNOOZE BUTTON (#5). The alarm will sound again when the snooze period (9 minutes) expires.
- The corresponding Alarm 1 or Alarm 2 indicator (alarm or radio) flashes on the display during the snooze period.
- To cancel the snooze period and the alarm, press  / MODE BUTTON (#9).

RADIO OPERATION

Listening to the radio





1. Tap the  / MODE BUTTON (#9) repeatedly to turn the unit on and select either AM or FM radio mode. The frequency of the station will show on the display.
2. Press and hold the MIN /  BUTTON (#3) OR HOUR /  BUTTON (#2) to search for the next / previous available station.
3. If the reception is poor, try Manual Tuning to fine-tune the station. Tap the MIN /  BUTTON (#3) OR HOUR /  BUTTON (#2) briefly to manually tune through the frequency band.
4. Adjust the  / + BUTTON (#8) and  / - BUTTON (#7) to obtain the desired sound level.
5. When you have finished listening, press and hold  / MODE BUTTON (#9) to turn the radio off.

NOTES:

- When in radio mode, the display will automatically switch back to showing the time after a few seconds.
- When listening to the radio, you can check the frequency of the station you are listening by tapping the MIN /  BUTTON (#3) OR HOUR /  BUTTON (#2). The unit will automatically change back to the time after a few seconds.

Setting the Radio Station Presets

The unit allows you to store up to 30 FM stations and 20 AM stations for easy recall at any time.

1. Press the  / MODE BUTTON (#9) repeatedly to turn on the unit and select either AM or FM radio mode.
2. Tune to the radio station you want to store in memory.
3. Press and hold the  / MEM / M + BUTTON (#1). The preset channel number "P01" will be flashing on the display.
4. To change the preset channel number location, press the MIN /  BUTTON (#3) OR HOUR /  BUTTON (#2) to step through the preset locations.
5. To confirm the preset location, press  / MEM / M + BUTTON (#1).
6. To store another station presets, repeat steps 2-5 above.

RECALLING A PRESET STATION

In AM or FM mode, tap the  / MEM / M + BUTTON (#1) repeatedly to select the preset channel.

TIPS FOR BEST RADIO RECEPTION

AM - The AM antenna is built inside the radio. If AM reception is weak, change the position of the unit until the internal antenna picks up the strongest signal.

FM - If FM reception is weak, fully extend the wire antenna and vary the position and location of the antenna until you find the strongest signal.

AUX-IN OPERATION

You can play other music sources (iPod, MP3 or other digital audio players) through the speakers of the QiCR-200 by connecting the AUX-IN JACK (#22) to your external player's audio out jack or headphone jack.

1. Plug one end of an audio cable (not included) into the AUX IN JACK (#22) and the other end of the cable to the headphone jack of your digital audio player.
2. Tap  / MODE BUTTON (#9) repeatedly to select AUX mode.
3. AUX will show on the LED Display.
4. Turn on and start playing the external device you plugged into the AUX IN JACK (#22).
5. Slowly adjust both the volume controls of your QiCR-200 and the external device until you reach a comfortable listening level.

Notes:

- If you connect the QiCR-200 to the Line-Out Jack on your external device, you only need to adjust the volume control of your QiCR-200. If you connect to the Headphone Jack of your external device, you may need to adjust both the volume controls of your external device and the QiCR-200 to obtain the desirable listening level.
- Remember to turn off the QiCR-200 when you have finished listening. Don't forget to switch off the power of your external audio device as well.

SLEEP OPERATION

The sleep timer turns off the unit automatically after a designated time has elapsed.

1. Tap the SLEEP BUTTON (#6) to enter sleep mode.
2. Repeatedly tap the SLEEP BUTTON (#6) to select the sleep timer 120 – 90 – 80 – 70 – 60 – 50 – 40 – 30 – 20 – 10 – 5 - OFF (in minutes). The unit will play for the selected length of time then turn off automatically.
3. To cancel the sleep timer, repeatedly tap the SLEEP BUTTON (#6) until the timer shows OFF.
4. To turn the unit "Off" before the selected length of time, press and hold the  / MODE BUTTON (#9) at any time.

Note: Tap the SLEEP BUTTON (#6) once to check the remaining sleep time.

DIMMER OPERATION

Tap the DIMMER BUTTON (#4) repeatedly to select the brightness settings of the display (High, Medium or Low).

Qi WIRELESS CHARGING

You can charge your Qi compatible phones wirelessly using the **Qi WIRELESS CHARGING PAD (#10)** located on top of the unit.

Place your Qi compatible device (back side down) on the **Qi WIRELESS CHARGING PAD (#10)**. The **Qi CHARGING INDICATOR (#16)** will light.

NOTE WHEN USING THE AM RADIO:

The **Qi WIRELESS CHARGING PAD (#10)** will turn off when the AM radio is on. Once the AM radio is turned off, the **Qi WIRELESS CHARGING PAD (#10)** will turn back on automatically.

CAUTION:

Remove your phone from any metal or magnetic protective case before placing it on the Charging Pad. Do not place any metal objects or magnetic-striped devices on Charging Pad. Doing so could damage the object or this unit.

Qi compatible phones with metallic finishes will charge normally.

USB CHARGING

If your phone doesn't feature wireless charging, you can still charge your phone with this unit by a connecting a USB charging cable (not included) to the USB Charging Port (dc 5v --- 2.1a) located on the back of the unit.

1. Plug the standard end of a USB charging cable (not included) into the **USB CHARGING PORT (#19)** located on the back of the QiCR-200. Plug the other end of the cable into the device you wish to charge.
2. Observe the battery charge indicator on your device to make sure the charging process starts normally.
3. Unplug the charging cable when your device is fully charged.

WARNING!

- The USB port located on the back of the QiCR-200 is only designed for charging a smart phone or portable device, and does not support data transfer or connection to a computer.
- Don't connect another USB charger to the USB charging port on the QiCR-200. This may damage the charging circuits on both devices and void the warranty.

CARE AND MAINTENANCE

- Clean the radio with a soft damp cloth and let all parts dry completely after cleaning.
- Do not use any aggressive cleaners, brushes with nylon bristles, sharp or metallic cleaning utensils, knives, hard scrapers and the like. They could damage the surfaces of the radio.
- Do not immerse the radio in water and do not let water getting into the housing of the radio.
- Unplug the power adaptor and clean the radio before storage.
- Always store the radio in a dry and clean place.

SPECIFICATIONS

Power: AC Adaptor:
 Input: AC 100-240V ~ 50/60Hz
 Output: DC 5V \equiv 3A \ominus \oplus

Backup batteries: 2 x AAA batteries (not included)
 Frequency Range: FM 87.5 – 108 MHz
 AM 520 – 1710 KHz

TROUBLESHOOTING GUIDE

If you experience difficulties in the use of this clock radio, please check the following or call 1-800-777-5331 for Customer Service and support.

SYMPTOM	POSSIBLE CAUSE	POSSIBLE SOLUTION
Power does not come on	Power adaptor connect unstable	Reconnect adaptor
No sound	VOLUME control at minimum position.	Increase Volume
Noise or sound distorted on AM or FM broadcast	- Station not tuned properly - FM: Antenna is not extended - AM : Internal antenna is not positioned correctly	- Retune Broadcast station - Fully extend the antenna - Reposition the unit until the best reception is obtained
USB charging is not working	USB cable is damaged or intermittent	Reconnect the cable again or try another charging cable.
No wireless charging	- The AM radio is on - Your Qi device is not properly placed on the charging pad	- Turn off the AM radio - Reposition your Qi device



At Spectra, environmental and social responsibility is a core value of our business. We are dedicated to continuous implementation of responsible initiatives with an aim to conserve and maintain the environment through responsible recycling.

Please visit us at <http://www.spectraintl.com/green.htm> for more information on Spectra's green initiatives or to find a recycler in your area.

90 DAY LIMITED WARRANTY AND SERVICE VALID IN THE U.S.A. ONLY

SPECTRA MERCHANDISING INTERNATIONAL, INC. warrants this unit to be free from defective materials or factory workmanship for a period of 90 days from the date of original customer purchase and provided the product is utilized within the U.S.A. This warranty is not assignable or transferable. Our obligation under this warranty is the repair or replacement of the defective unit or any part thereof, except batteries, when it is returned to the SPECTRA Service Department, accompanied by proof of the date of original consumer purchase, such as a duplicate copy of a sales receipt.

You must pay all shipping charges required to ship the product to SPECTRA for warranty service. If the product is repaired or replaced under warranty, the return charges will be at SPECTRA's expense. There are no other express warranties other than those stated herein.

This warranty is valid only in accordance with the conditions set forth below:

1. The warranty applies to the SPECTRA product only while:
 - a. It remains in the possession of the original purchaser and proof of purchase is demonstrated.
 - b. It has not been subjected to accident, misuse, abuse, improper service, usage outside the descriptions and warnings covered within the user manual or non-SPECTRA approved modifications.
 - c. Claims are made within the warranty period.
2. This warranty does not cover damage or equipment failure caused by electrical wiring not in compliance with electrical codes or SPECTRA user manual specifications, or failure to provide reasonable care and necessary maintenance as outlined in the user manual.
3. Warranty of all SPECTRA products applies to residential use only and is void when products are used in a nonresidential environment or installed outside the United States.

This warranty gives you specific legal rights, and you may also have other rights which vary from state to state. TO OBTAIN SERVICE please remove all batteries (if any) and pack the unit carefully and send it freight prepaid to SPECTRA at the address shown below. IF THE UNIT IS RETURNED WITHIN THE WARRANTY PERIOD shown above, please include a proof of purchase (dated cash register receipt) so that we may establish your eligibility for warranty service and repair of the unit without cost. Also include a note with a description explaining how the unit is defective. A customer service representative may need to contact you regarding the status of your repair, so please include your name, address, phone number and email address to expedite the process. IF THE UNIT IS OUTSIDE THE WARRANTY PERIOD, please include a check for **\$25.00** to cover the cost of repair, handling and return postage. All out of warranty returns must be sent prepaid.

It is recommended that you contact SPECTRA first at 1-800-777-5331 or by email at custserv@spectraintl.com for updated information on the unit requiring service. In some cases, the model you have may be discontinued, and SPECTRA reserves the right to offer alternative options for repair or replacement.

SPECTRA MERCHANDISING INTERNATIONAL, INC.
4230 North Normandy Avenue, Chicago, IL60634, USA. 1-800-777-5331

To register your product, visit the link on the website below to enter your information.
<http://www.spectraintl.com/wform.htm>