

USER'S MANUAL
COMBINATION CARBON MONOXIDE & SMOKE ALARM

SEPARATE SENSORS TO DETECT SMOKE AND CO; THE TWO ALARM SYSTEMS WORK INDEPENDENTLY

POWERED BY "AA" BATTERIES

VOICE ALERTS, ALARM TELLS YOU TYPE AND LOCATION OF DANGER WITH EASY ACCESS DOOR FOR BATTERY REPLACEMENT

IMPORTANT! PLEASE READ CAREFULLY AND SAVE.
 The warnings/limitations card and manual contains important information about your smoke & carbon monoxide (CO) alarm's operation. If you are installing this alarm for use by others, you must leave this manual—or a copy of it—with the end user. Reference product card for additional information.
 Para el manual del usuario en español, por favor visite www.firstalert.com.

Printed in Mexico
 M06-0468-160287-US L 12/17
 CONFORMS TO UL STD 217 AND UL STD 2034
 Model FC1200

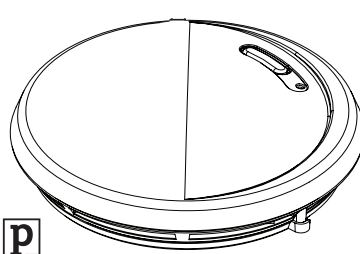

INTRODUCTION

All First Alert® smoke alarms conform to regulatory requirements, including UL217 and are designed to detect particles of combustion. Smoke particles of varying number and size are produced in all fires.

Ionization technology is generally more sensitive than photoelectric technology at detecting small particles, which tend to be produced in greater amounts by flaming fires, which consume combustible materials rapidly and spread quickly. Sources of these fires may include paper burning in a wastebasket, or a grease fire in the kitchen.

Photoelectric technology is generally more sensitive than ionization technology at detecting large particles, which tend to be produced in greater amounts by smoldering fires, which may smolder for hours before bursting into flame. Sources of these fires may include cigarettes burning in couches or bedding.

For maximum protection, use both types of smoke alarms on each level and in every bedroom of your home.

© 2018 BRK Brands, Inc. All rights reserved. Distributed by BRK Brands, Inc. - BRK Brands, Inc. is a subsidiary of Newell Brands Inc. (NYSE:NWL) - 3901 Liberty Street, Aurora, IL, 60504-8122 - Customer Service Team: (800) 323-9005 - www.firstalert.com - www.bneltronics.com

FOLLOW THESE SIMPLE STEPS

- Hold base firmly and twist the mounting bracket clockwise to separate it from the base.
- Hold the mounting bracket against the ceiling (or wall) so the two clusters of universal mounting holes are aligned approximately at the 9:00 and 3:00 o'clock positions. See image. Choose one of the three sets of holes shown, A, B or C (see image) and trace around one of the sets. Be sure to choose a top and bottom slot on opposite sides so you can rotate the universal mounting bracket into position later. This will make it easier in the future to remove the mounting bracket without completely removing the screws.
- Put the unit where it won't get covered with dust when you drill the mounting holes.
- Using a 3/16" (5 mm) drill bit, drill a hole through the center of the oval outlines you traced.
- Insert the plastic screw anchors (in the plastic bag with screws) into the holes. Tap the screw anchors gently with a hammer, if necessary, until they are flush with the ceiling or wall.
- Install the screws but do not tighten completely. Attach the mounting bracket by aligning the screws in the open portion of the universal mounting slots and rotating the bracket into place. Tighten the screws until they are snug to secure the bracket. Do not over tighten.
- Install the batteries (included). Open the battery door. Match the terminals on the ends of each battery with the terminals on the unit. Match "+" to "+" and "-" to "-". Push the batteries in until they snap securely and cannot be shaken loose. If the batteries are not snapped in completely, the unit cannot receive battery power.
NOTE: After you install the batteries, the power indicator light may flash. (If the unit alarms, the light will blink rapidly, and the horn will repeatedly sound 3 beeps, pause, 3 beeps.)
- Position the base of the alarm over the mounting bracket and turn. Turn the alarm clockwise until the unit is in place.
- Test the alarm. See "Weekly Testing."

OPTIONAL LOCKING FEATURE

The optional locking feature is designed to prevent unauthorized removal of the alarm. It is not necessary to activate the lock in single-family households where unauthorized alarm removal is not a concern.

Tools you will need: Needle-nose pliers or utility knife, standard flathead screwdriver

The feature uses a locking pin which is molded into the mounting bracket. Remove locking pin by using needle-nose pliers or a utility knife.

IMPORTANT!
 To permanently remove the locking pin, insert a flathead screwdriver between the locking pin and the lock and pry the pin out of the lock.

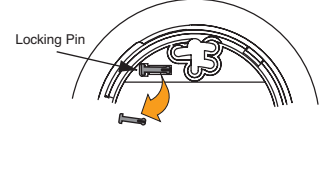

TO LOCK THE MOUNTING BRACKET

- Using needle-nose pliers, detach the pin from the mounting bracket.
- Insert the locking pin through the hole on the back of the smoke alarm as shown in the diagram.
- When you attach the alarm to the mounting bracket the locking pin's head will fit into a notch on the bracket.

USER'S MANUAL
COMBINATION CARBON MONOXIDE & SMOKE ALARM

SEPARATE SENSORS TO DETECT SMOKE AND CO; THE TWO ALARM SYSTEMS WORK INDEPENDENTLY

POWERED BY "AA" BATTERIES

VOICE ALERTS, ALARM TELLS YOU TYPE AND LOCATION OF DANGER WITH EASY ACCESS DOOR FOR BATTERY REPLACEMENT

IMPORTANT! PLEASE READ CAREFULLY AND SAVE.
 The warnings/limitations card and manual contains important information about your smoke & carbon monoxide (CO) alarm's operation. If you are installing this alarm for use by others, you must leave this manual—or a copy of it—with the end user. Reference product card for additional information.
 Para el manual del usuario en español, por favor visite www.firstalert.com.

Printed in Mexico
 M06-0468-160287-US L 12/17
 CONFORMS TO UL STD 217 AND UL STD 2034
 Model FC1200

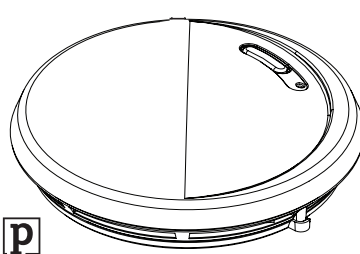

INTRODUCTION

All First Alert® smoke alarms conform to regulatory requirements, including UL217 and are designed to detect particles of combustion. Smoke particles of varying number and size are produced in all fires.

Ionization technology is generally more sensitive than photoelectric technology at detecting small particles, which tend to be produced in greater amounts by flaming fires, which consume combustible materials rapidly and spread quickly. Sources of these fires may include paper burning in a wastebasket, or a grease fire in the kitchen.

Photoelectric technology is generally more sensitive than ionization technology at detecting large particles, which tend to be produced in greater amounts by smoldering fires, which may smolder for hours before bursting into flame. Sources of these fires may include cigarettes burning in couches or bedding.

For maximum protection, use both types of smoke alarms on each level and in every bedroom of your home.

FOLLOW THESE SIMPLE STEPS

- Hold base firmly and twist the mounting bracket clockwise to separate it from the base.
- Hold the mounting bracket against the ceiling (or wall) so the two clusters of universal mounting holes are aligned approximately at the 9:00 and 3:00 o'clock positions. See image. Choose one of the three sets of holes shown, A, B or C (see image) and trace around one of the sets. Be sure to choose a top and bottom slot on opposite sides so you can rotate the universal mounting bracket into position later. This will make it easier in the future to remove the mounting bracket without completely removing the screws.
- Put the unit where it won't get covered with dust when you drill the mounting holes.
- Using a 3/16" (5 mm) drill bit, drill a hole through the center of the oval outlines you traced.
- Insert the plastic screw anchors (in the plastic bag with screws) into the holes. Tap the screw anchors gently with a hammer, if necessary, until they are flush with the ceiling or wall.
- Install the screws but do not tighten completely. Attach the mounting bracket by aligning the screws in the open portion of the universal mounting slots and rotating the bracket into place. Tighten the screws until they are snug to secure the bracket. Do not over tighten.
- Install the batteries (included). Open the battery door. Match the terminals on the ends of each battery with the terminals on the unit. Match "+" to "+" and "-" to "-". Push the batteries in until they snap securely and cannot be shaken loose. If the batteries are not snapped in completely, the unit cannot receive battery power.
NOTE: After you install the batteries, the power indicator light may flash. (If the unit alarms, the light will blink rapidly, and the horn will repeatedly sound 3 beeps, pause, 3 beeps.)
- Position the base of the alarm over the mounting bracket and turn. Turn the alarm clockwise until the unit is in place.
- Test the alarm. See "Weekly Testing."

OPTIONAL LOCKING FEATURE

The optional locking feature is designed to prevent unauthorized removal of the alarm. It is not necessary to activate the lock in single-family households where unauthorized alarm removal is not a concern.

Tools you will need: Needle-nose pliers or utility knife, standard flathead screwdriver

The feature uses a locking pin which is molded into the mounting bracket. Remove locking pin by using needle-nose pliers or a utility knife.

IMPORTANT!
 To permanently remove the locking pin, insert a flathead screwdriver between the locking pin and the lock and pry the pin out of the lock.

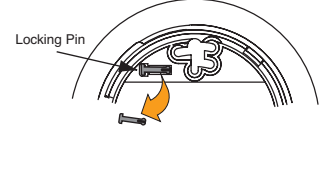

TO LOCK THE MOUNTING BRACKET

- Using needle-nose pliers, detach the pin from the mounting bracket.
- Insert the locking pin through the hole on the back of the smoke alarm as shown in the diagram.
- When you attach the alarm to the mounting bracket the locking pin's head will fit into a notch on the bracket.

BASIC SAFETY INFORMATION

IMPORTANT!
 • Dangers, Warnings, and Cautions alert you to important operating instructions or to potentially hazardous situations. Pay special attention to these items.

CAUTION!
 • This smoke/CO alarm is approved for use in single-family residences. It is NOT designed for marine or RV use.

WARNING!
 • This combination smoke/carbon monoxide alarm has two separate alarms. The CO alarm is not designed to detect fire or any other gas. It will only indicate the presence of carbon monoxide gas at the sensor. Carbon monoxide gas may be present in other areas. The smoke alarm will only indicate the presence of smoke that reaches the sensor. The smoke alarm is not designed to sense gas, heat or flames.

CAUTION!
 • This unit will not operate without battery power. The smoke/CO alarm cannot work until you activate the battery power pack.

NEVER ignore any alarm. See "If Your Smoke/CO Alarm Sounds" for more information on how to respond to an alarm. Failure to respond can result in injury or death.

• The Silence Features are for your convenience only and will not correct a problem. See "Using the Silence Features" for details. Always check your home for a potential problem after any alarm. Failure to do so can result in injury or death.

• Test this smoke/CO alarm once a week. If the alarm ever fails to test correctly, have it replaced immediately! If the alarm is not working properly, it cannot alert you to a problem.

• This product is intended for use in ordinary indoor locations of family living units. It is not designed to measure CO levels in compliance with Occupational Safety and Health Administration (OSHA) commercial or industrial standards. Individuals with medical conditions that may make them more sensitive to carbon monoxide may consider using warning devices which provide audible and visual signals for carbon monoxide concentrations under 30 ppm. For additional information on carbon monoxide and your medical condition contact your physician.

INSTALLATION

WHERE TO INSTALL THIS ALARM
 Minimum coverage for smoke alarms, as recommended by the National Fire Protection Association (NFPA), is one smoke alarm on every level, in every sleeping area, and in every bedroom (See "Regulatory Information for Smoke Alarms" for details on the NFPA recommendations). For CO alarms, the National Fire Protection Association (NFPA) recommends that a CO alarm should be centrally located outside of each separate sleeping area in the immediate vicinity of the bedrooms. For added protection, install additional CO alarms in each separate bedroom, and on every level of your home.

NOTE: For added protection, install an additional smoke/CO alarm at least 15 feet (4.6 meters) away from the furnace or fuel burning heat source where possible. In smaller homes or in manufactured homes where this distance cannot be maintained, install the alarm as far away as possible from the furnace or other fuel burning source. Installing the alarm closer than 15 feet (4.6 meters) will not harm the alarm, but may increase the frequency of unwanted alarms.

IN GENERAL, INSTALL COMBINATION SMOKE AND CARBON MONOXIDE ALARMS:

- On every level of your home, including finished attics and basements.
- Inside every bedroom, especially if people sleep with the door partly or completely closed.
- In the hall near every sleeping area. If your home has multiple sleeping areas, install a unit in each. If a hall is more than 40 feet (12 meters) long, install a unit at each end.
- At the top of first-to-second level stairs.
- At the bottom of the basement stairs.

• For additional coverage, install alarms in all rooms, halls, and storage areas, where temperatures normally remain between 40° F and 100° F (4.4° C and 37.8° C).

TO UNLOCK THE MOUNTING BRACKET

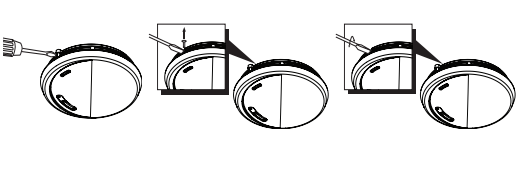
- Insert a flathead screwdriver in between the mounting bracket and the locking pin.
 - Pry the alarm away from the mounting bracket by pushing in on the screwdriver and turning the alarm counterclockwise (left) at the same time.
- 

TROUBLESHOOTING GUIDE		
IF THE ALARM...	PROBLEM...	YOU SHOULD...
Horn "chirps" about once per minute.	Low Battery Warning.	Install two new AA batteries*.
Horn does three "chirps" every minute; LED has 3 rapid Green flashes with "chirps"	MalFUNCTION SIGNAL. Device is not working properly, and needs to be replaced.	Units under warranty should be returned to manufacturer for replacement. See "Limited Warranty" for details.
The light flashes GREEN and the horn sounds 5 "chirps" every minute.	END OF LIFE SIGNAL. Alarm needs to be replaced.	Immediately replace the alarm.
CARBON MONOXIDE ALARM ONLY:		
CO alarm goes back into alarm 4 minutes after you silence it.	CO levels indicate a potentially dangerous situation.	IF YOU ARE FEELING SYMPTOMS OF CO POISONING, EVACUATE your home and call 911 or the Fire Department. Refer to "If The CO Alarm Sounds" for details.
CO alarm sounds frequently even though no high levels of CO are revealed in an investigation.	The CO alarm may be improperly located. Refer to "Where to Install This Alarm" for details.	Relocate your alarm. If frequent alarms continue, have home rechecked for potential CO problems. You may be experiencing an intermittent CO problem
SMOKE ALARM ONLY:		
Smoke alarm sounds when no smoke is visible.	Unwanted alarm may be caused by non-emergency source like cooking smoke.	Silence alarm using Test/Silence button; clean the alarm's cover with a soft, clean cloth. If frequent unwanted alarms continue, relocate your alarm. Alarm may be too close to a kitchen, cooking appliance, or steamy bathroom.
*For a list of acceptable replacement batteries, see "Regular Maintenance."		
If you have questions that cannot be answered by reading this manual, call the Customer Service Team at 1-800-323-9005		

RECOMMENDED PLACEMENT:

Smoke Alarm
 One on every level and in every bedroom

Carbon Monoxide Alarm
 One on every level and in every bedroom

Fire Extinguisher
 One on every level, plus kitchen and garage

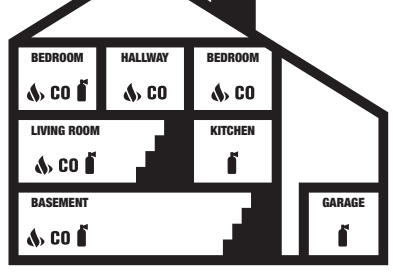

When installing on the wall, the top edge of smoke alarms should be placed between 4 inches (102 mm) and 12 inches (305 mm) from the wall/ceiling line.

- When installing on the ceiling, place the alarm as close to the center as possible.
- In other case, install at least 4 inches (102 mm) from where the wall and ceiling meet. See "Avoiding Dead Air Spaces" for more information.

NOTE: For any location, make sure no door or other obstruction could keep carbon monoxide or smoke from reaching the alarm.

INSTALLING SMOKE/CO ALARMS IN MOBILE HOMES

For minimum security install one smoke/CO alarm as close to each sleeping area as possible. For more security, put one unit in each room. Many older mobile homes (especially those built before 1978) have little or no insulation. If your mobile home is not well insulated, or if you are unsure of the amount of insulation, it is important to install units on inside walls only.

WHERE THIS ALARM SHOULD NOT BE INSTALLED

- DO NOT LOCATE THIS SMOKE/CO ALARM:**
- In garages, furnace rooms, crawl spaces and unfinished attics. Avoid extremely dusty, dirty or greasy areas.
 - Where combustion particles are produced. Combustion particles form when something burns. Areas to avoid include poorly ventilated kitchens, garages, and furnace rooms. Keep units at least 20 feet (6 meters) from the sources of combustion particles (stoves, furnace, water heater, space heater) if possible. In areas where a 20-foot (6 meter) distance is not possible – in modular, mobile, or smaller homes, for example – it is recommended the smoke alarm be placed as far from these fuel-burning sources as possible. The placement recommendations are intended to keep these alarms at a reasonable distance from a fuel-burning source, and thus reduce "unwanted" alarms. Unwanted alarms can occur if a smoke alarm is placed directly next to a fuel-burning source. Ventilate these areas as much as possible.
 - Within 5 feet (1.5 meters) of any cooking appliance. In air streams near kitchens. Air currents can draw cooking smoke into the smoke sensor and cause unwanted alarms.
 - In extremely humid areas. This alarm should be at least 10 feet (3 meters) from a shower, sauna, humidifier, vaporizer, dishwasher, laundry room, utility room, or other source of high humidity.
 - In direct sunlight.
 - In turbulent air, like near ceiling fans or open windows. Blowing air may prevent CO or smoke from reaching the sensors.

TESTING & MAINTENANCE

WEEKLY TESTING
WARNING!
 • NEVER use an open flame of any kind to test this unit. You might accidentally damage or set fire to the unit or to your home. The walk-in test switch accurately tests the unit's operation as required by Underwriters Laboratories, Inc. (UL). NEVER use vehicle exhaust! Exhaust may cause permanent damage and voids your warranty.

• DO NOT stand close to the alarm when the horn is sounding. Exposure at close range may be harmful to your hearing. When testing, step away when horns starts sounding.

CAUTION!
 It is important to test this unit every week to make sure it is working properly. Using the test button is the recommended way to test this smoke/CO alarm.

You can test this smoke/CO alarm: Press and hold the Test/Silence button 3-5 seconds until unit starts to alarm. During testing, you will see and hear the following sequence:

- The Horn will sound 3 beeps, pause, 3 beeps. The LED flashes Red.
- Next the Horn will sound 4 beeps, pause, 4 beeps. The LED flashes Red.

If the unit does not alarm, make sure the batteries are correctly installed, and test again. If the unit still does not alarm, replace it immediately.

REGULAR MAINTENANCE
 This unit has been designed to be as maintenance free as possible, but there are a few simple things you must do to keep it working properly.

- Test it at least once a week.
- Clean the smoke/CO alarm at least once a month; gently vacuum the outside of the smoke/CO alarm using your household vacuum's soft brush attachment. A can of clean compressed air (sold at computer or office supply stores) may also be used. Follow manufacturer instructions for use. Test the smoke/CO alarm. Never use water, cleaners or solvents since they may damage the unit.
- If the smoke/CO alarm becomes contaminated by excessive dirt, dust and/or grime, and cannot be cleaned to avoid unwanted alarms, replace the unit immediately.
- Relocate the unit if it sounds frequent unwanted alarms. See "Where This Alarm Should Not Be Installed" for details.

CHOOSING A REPLACEMENT BATTERY:
 Your smoke/CO alarm requires two standard AA batteries. The following batteries are acceptable as replacements: Eveready Energizer DSI or Duracell MN1500. These batteries are available at many local retail stores.

WARNING!
 • Always use the exact batteries specified by this user's Manual. DO NOT use rechargeable batteries. Clean the battery contacts and also those of the device prior to battery installation. Install batteries correctly with regard to polarity (+ and -).

WARNING!
 • Please dispose of or recycle used batteries properly, following any local regulations. Consult your local waste management authority or recycling organization to find an electronics recycling facility in your area. DO NOT DISPOSE OF BATTERIES IN FIRE. BATTERIES MAY EXPLODE OR LEAK.

• Keep battery out of reach of children. In the event a battery is swallowed, immediately contact your poison control center, your physician, or the National Battery Ingestion hotline at 202-625-3333 as serious injury may occur.

IMPORTANT!
 Actual battery service life depends on the smoke/CO alarm and the environment in which it is installed. All the batteries specified above are acceptable replacement batteries for this unit. Regardless of the manufacturer's suggested battery life, you MUST replace the battery immediately once the unit starts "chirping" (the "Low Battery Warning").

RECOMMENDED PLACEMENT:

Smoke Alarm
 One on every level and in every bedroom

Carbon Monoxide Alarm
 One on every level and in every bedroom

Fire Extinguisher
 One on every level, plus kitchen and garage

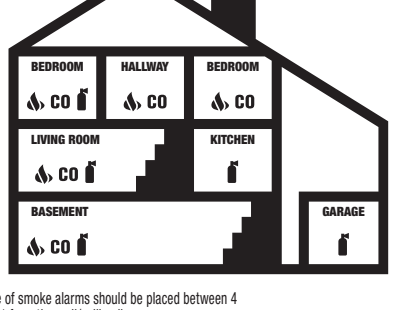

When installing on the wall, the top edge of smoke alarms should be placed between 4 inches (102 mm) and 12 inches (305 mm) from the wall/ceiling line.

- When installing on the ceiling, place the alarm as close to the center as possible.
- In other case, install at least 4 inches (102 mm) from where the wall and ceiling meet. See "Avoiding Dead Air Spaces" for more information.

NOTE: For any location, make sure no door or other obstruction could keep carbon monoxide or smoke from reaching the alarm.

INSTALLING SMOKE/CO ALARMS IN MOBILE HOMES

For minimum security install one smoke/CO alarm as close to each sleeping area as possible. For more security, put one unit in each room. Many older mobile homes (especially those built before 1978) have little or no insulation. If your mobile home is not well insulated, or if you are unsure of the amount of insulation, it is important to install units on inside walls only.

WHERE THIS ALARM SHOULD NOT BE INSTALLED

- DO NOT LOCATE THIS SMOKE/CO ALARM:**
- In garages, furnace rooms, crawl spaces and unfinished attics. Avoid extremely dusty, dirty or greasy areas.
 - Where combustion particles are produced. Combustion particles form when something burns. Areas to avoid include poorly ventilated kitchens, garages, and furnace rooms. Keep units at least 20 feet (6 meters) from the sources of combustion particles (stoves, furnace, water heater, space heater) if possible. In areas where a 20-foot (6 meter) distance is not possible – in modular, mobile, or smaller homes, for example – it is recommended the smoke alarm be placed as far from these fuel-burning sources as possible. The placement recommendations are intended to keep these alarms at a reasonable distance from a fuel-burning source, and thus reduce "unwanted" alarms. Unwanted alarms can occur if a smoke alarm is placed directly next to a fuel-burning source. Ventilate these areas as much as possible.
 - Within 5 feet (1.5 meters) of any cooking appliance. In air streams near kitchens. Air currents can draw cooking smoke into the smoke sensor and cause unwanted alarms.
 - In extremely humid areas. This alarm should be at least 10 feet (3 meters) from a shower, sauna, humidifier, vaporizer, dishwasher, laundry room, utility room, or other source of high humidity.
 - In direct sunlight.
 - In turbulent air, like near ceiling fans or open windows. Blowing air may prevent CO or smoke from reaching the sensors.

TESTING & MAINTENANCE

WEEKLY TESTING
WARNING!
 • NEVER use an open flame of any kind to test this unit. You might accidentally damage or set fire to the unit or to your home. The walk-in test switch accurately tests the unit's operation as required by Underwriters Laboratories, Inc. (UL). NEVER use vehicle exhaust! Exhaust may cause permanent damage and voids your warranty.

• DO NOT stand close to the alarm when the horn is sounding. Exposure at close range may be harmful to your hearing. When testing, step away when horns starts sounding.

CAUTION!
 It is important to test this unit every week to make sure it is working properly. Using the test button is the recommended way to test this smoke/CO alarm.

You can test this smoke/CO alarm: Press and hold the Test/Silence button 3-5 seconds until unit starts to alarm. During testing, you will see and hear the following sequence:

- The Horn will sound 3 beeps, pause, 3 beeps. The LED flashes Red.
- Next the Horn will sound 4 beeps, pause, 4 beeps. The LED flashes Red.

If the unit does not alarm, make sure the batteries are correctly installed, and test again. If the unit still does not alarm, replace it immediately.

REGULAR MAINTENANCE
 This unit has been designed to be as maintenance free as possible, but there are a few simple things you must do to keep it working properly.

- Test it at least once a week.
- Clean the smoke/CO alarm at least once a month; gently vacuum the outside of the smoke/CO alarm using your household vacuum's soft brush attachment. A can of clean compressed air (sold at computer or office supply stores) may also be used. Follow manufacturer instructions for use. Test the smoke/CO alarm. Never use water, cleaners or solvents since they may damage the unit.
- If the smoke/CO alarm becomes contaminated by excessive dirt, dust and/or grime, and cannot be cleaned to avoid unwanted alarms, replace the unit immediately.
- Relocate the unit if it sounds frequent unwanted alarms. See "Where This Alarm Should Not Be Installed" for details.

CHOOSING A REPLACEMENT BATTERY:
 Your smoke/CO alarm requires two standard AA batteries. The following batteries are acceptable as replacements: Eveready Energizer DSI or Duracell MN1500. These batteries are available at many local retail stores.

WARNING!
 • Always use the exact batteries specified by this user's Manual. DO NOT use rechargeable batteries. Clean the battery contacts and also those of the device prior to battery installation. Install batteries correctly with regard to polarity (+ and -).

WARNING!
 • Please dispose of or recycle used batteries properly, following any local regulations. Consult your local waste management authority or recycling organization to find an electronics recycling facility in your area. DO NOT DISPOSE OF BATTERIES IN FIRE. BATTERIES MAY EXPLODE OR LEAK.

• Keep battery out of reach of children. In the event a battery is swallowed, immediately contact your poison control center, your physician, or the National Battery Ingestion hotline at 202-625-3333 as serious injury may occur.

IMPORTANT!
 Actual battery service life depends on the smoke/CO alarm and the environment in which it is installed. All the batteries specified above are acceptable replacement batteries for this unit. Regardless of the manufacturer's suggested battery life, you MUST replace the battery immediately once the unit starts "chirping" (the "Low Battery Warning").

WHERE THIS ALARM SHOULD NOT BE INSTALLED (CONTINUED)...

- In areas where temperature is colder than 40° F (4.4° C) or hotter than 100° F (37.8° C). These areas include non-airconditioned crawl spaces, unfinished attics, uninsulated or poorly insulated ceilings, porches, and garages.
- In insect infested areas. Insects can clog the openings to the sensing chamber.
- Less than 12 inches (305 mm) away from fluorescent lights. Electrical "noise" can interfere with the sensor.
- In "dead air" spaces. See "Avoiding Dead Air Spaces".

AVOIDING DEAD AIR SPACES

"Dead air" spaces may prevent smoke from reaching the smoke alarm. To avoid dead air spaces, follow installation recommendations below.

On ceilings, install smoke alarms as close to the center of the ceiling as possible. If this is not possible, install the smoke alarm at least 4 inches (102 mm) from the wall or corner.

For wall mounting (if allowed by building codes), the top edge of smoke alarms should be placed between 4 inches (102 mm) and 12 inches (305 mm) from the wall/ceiling line, below typical "dead air" spaces.

On a peaked, gabled, or cathedral ceiling, install the first smoke alarm within 3 feet (0.9 meters) of the peak of the ceiling, measured horizontally. Additional smoke alarms may be required depending on the length, angle, etc. of the ceiling's slope. Refer to NFPA 72 for details on requirements for sloped or peaked ceilings.

HOW TO INSTALL THIS ALARM

IMPORTANT!
 • This combination smoke/CO alarm was designed to be mounted on the ceiling or wall. It is not a tabletop device. You must install this device on the ceiling or wall as outlined below. Read "Where to Install This Alarm" before starting.

CAUTION!
 • Do not connect this unit to any other alarm or auxiliary device. It is a single-station unit that cannot be linked to other devices. Connecting anything else to this unit may prevent it from working properly.

• Do not install this unit over an electrical junction box. Air currents around junction boxes can prevent smoke from reaching the sensing chamber and prevent the unit from alarming. Only AC-powered units are intended for installation over junction boxes. This unit is designed to be mounted on the ceiling, or on the wall if necessary.

Tools you will need: pencil, drill with 3/16" (5 mm) drill bit, standard flathead screwdriver, hammer

THE PARTS OF THIS SMOKE/CO ALARM

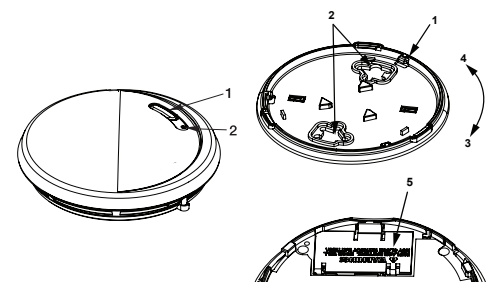
- Test/Silence button
 - Dual Power indicator light and alarm indicator. Green LED provides visual indication of an alarm memory condition. Red LED provides visual indication of an alarm and hush modes
 - Mounting bracket
 - Mounting slots
 - Turn this way to attach
 - Turn this way to remove
 - Battery door, install batteries here
- 

FIRE SAFETY TIPS

Follow safety rules and prevent hazardous situations: 1) Use smoking materials properly. Never smoke in bed. 2) Keep matches or lighters away from children; 3) Store flammable materials in proper containers; 4) Keep electrical appliances in good condition and don't overload electrical circuits; 5) Keep stoves, barbecue grills, fireplaces and chimneys grease- and debris-free; 6) Never leave anything cooking on the stove unattended; 7) Keep portable heaters and open flames, like candles, away from flammable materials; 8) Don't let rubbish accumulate. Keep alarms clean, and test them weekly. Replace alarms immediately if they are not working properly. Smoke alarms that do not work cannot alert you to a fire. Keep at least one working fire extinguisher on every level, and an additional one in the kitchen. Have fire escape ladders or other reliable means of escape from an upper level in case stairs are blocked.

IF YOUR SMOKE/CO ALARM SOUNDS

WHAT TO DO FIRST—IDENTIFY THE TYPE OF ALARM

Type of alarm	What You See and Hear	"ALARM-MOVE TO FRESH AIR" If you hear the CO alarm horn and the CO red light is flashing, move everyone to a source of fresh air. DO NOT remove the batteries!
Carbon Monoxide (CO)	CO LED: Flashes Red Horn: 4 beeps, pause, 4 beeps, pause	WARNING! Alarms have various limitations. See "General Limitations of smoke/CO alarms" for details.
Smoke	Smoke LED: Flashes Red Horn: 3 beeps, pause, 3 beeps, pause	

IF THE CO ALARM SOUNDS

WARNING!
 Actuation of your CO alarm indicates the presence of carbon monoxide (CO) which can kill you. In other words, when your CO alarm sounds, you must not ignore it!

IF THE CO ALARM SIGNAL SOUNDS:

- Press the Test/Silence button.
- Call your emergency services, fire department or 911. Write down the number of your local emergency service here:

3. Immediately move to fresh air—outdoors or by an open door or window. Do a head count to check that all persons are accounted for. Do not re-enter the premises, or move away from the open door or window until the emergency services responder has arrived, the premises have been aired out, and your CO alarm remains in its normal condition.

4. After following steps 1-3, if your CO alarm reactivates within a 24-hour period, repeat steps 1-3 and call a qualified appliance technician to investigate for sources of CO from fuel-burning equipment and appliances, and inspect for proper operation of this equipment. If problems are identified during this inspection have the equipment serviced immediately. Note any combustion equipment not inspected by the technician, and consult the manufacturers' instructions, or contact the manufacturers directly, for more information about CO safety and this equipment. Make sure that motor vehicles are not, and have not, been operating in an attached garage or adjacent to the residence. Write down the number of a qualified appliance technician here:

NOTE: A qualified appliance technician is defined as "a person, firm, corporation, or company that either in person or through a representative, is engaged in and responsible for the installation, testing, servicing, or replacement of heating, ventilation, air conditioning (HVAC) equipment, combustion appliances and equipment, and/or gas fireplaces or other decorative combustion equipment."

WHERE THIS ALARM SHOULD NOT BE INSTALLED (CONTINUED)...

- In areas where temperature is colder than 40° F (4.4° C) or hotter than 100° F (37.8° C). These areas include non-airconditioned crawl spaces, unfinished attics, uninsulated or poorly insulated ceilings, porches, and garages.
- In insect infested areas. Insects can clog the openings to the sensing chamber.
- Less than 12 inches (305 mm) away from fluorescent lights. Electrical "noise" can interfere with the sensor.
- In "dead air" spaces. See "Avoiding Dead Air Spaces".

AVOIDING DEAD AIR SPACES

"Dead air" spaces may prevent smoke from reaching the smoke alarm. To avoid dead air spaces, follow installation recommendations below.

On ceilings, install smoke alarms as close to the center of the ceiling as possible. If this is not possible, install the smoke alarm at least 4 inches (102 mm) from the wall or corner.

For wall mounting (if allowed by building codes), the top edge of smoke alarms should be placed between 4 inches (102 mm) and 12 inches (305 mm) from the wall/ceiling line, below typical "dead air" spaces.

On a peaked, gabled, or cathedral ceiling, install the first smoke alarm within 3 feet (0.9 meters) of the peak of the ceiling, measured horizontally. Additional smoke alarms may be required depending on the length, angle, etc. of the ceiling's slope. Refer to NFPA 72 for details on requirements for sloped or peaked ceilings.

HOW TO INSTALL THIS ALARM

IMPORTANT!
 • This combination smoke/CO alarm was designed to be mounted on the ceiling or wall. It is not a tabletop device. You must install this device on the ceiling or wall as outlined below. Read "Where to Install This Alarm" before starting.

CAUTION!
 • Do not connect this unit to any other alarm or auxiliary device. It is a single-station unit that cannot be linked to other devices. Connecting anything else to this unit may prevent it from working properly.

• Do not install this unit over an electrical junction box. Air currents around junction boxes can prevent smoke from reaching the sensing chamber and prevent the unit from alarming. Only AC-powered units are intended for installation over junction boxes. This unit is designed to be mounted on the ceiling, or on the wall if necessary.

IF THE SMOKE ALARM SOUNDS: RESPONDING TO AN ALARM

▲WARNING!

- If the unit alarms and you are not testing the unit, it is warning you of a potentially dangerous situation that requires your immediate attention. NEVER ignore an alarm. Ignoring the alarm may result in injury or death.
- Never remove the batteries from a battery operated smoke/CO alarm to stop an unwanted alarm (caused by cooking smoke, etc.). Removing batteries disables the alarm so it cannot sense smoke, and removes your protection. Instead open a window or fan the smoke away from the unit. The alarm will reset automatically.
- If the unit alarms get everyone out of the house immediately.

WHAT TO DO IN CASE OF FIRE

- Don't panic; stay calm. Follow your family escape plan.
- Get out of the house as quickly as possible. Don't stop to get dressed or collect anything.
- Feel doors with the back of your hand before opening them. If a door is cool, open it slowly. Don't open a hot door. Keep doors and windows closed, unless you must escape through them.
- Cover your nose and mouth with a cloth (preferably damp). Take short, shallow breaths.
- Meet at a planned meeting place outside your home, and do a head count to make sure everybody got out safely.
- Call the Fire Department as soon as possible from outside. Give your address, then your name.
- Never go back inside a burning building for any reason.
- Contact your Fire Department for ideas on making your home safer.

USING THE SILENCE FEATURE

▲WARNING!

Never remove the batteries to quiet an unwanted alarm. Removing the batteries disables the alarm and removes your protection.

The silence feature is intended to temporarily silence the horn while you identify and correct the problem. Do not use the silence feature in emergency situations. It will not correct a CO problem or extinguish a fire. The silence feature can temporarily quiet an unwanted alarm for several minutes. Press the Test/Silence button on the alarm cover for at least 3-5 seconds. After the Test/Silence button is released, the Red LED blinks during the silence mode.

When the smoke alarm is silenced	When the CO alarm is silenced
The smoke alarm will remain silent for up to 15 minutes, then return to normal operation.	The CO alarm will remain silent for up to 4 minutes.
If the smoke has not cleared—or continues to increase—the device will go back into alarm.	After 4 minutes, if CO levels remain potentially dangerous the horn will start sounding again.

SILENCING THE LOW BATTERY WARNING

This silence feature can temporarily quiet the Low Battery Warning "chirp". Press the Test/Silence button on the alarm.

Once the Low Battery Warning "chirp" silence feature is activated, the unit continues to flash the Green light once a minute. After time, the low battery "chirp" will resume. Replace the batteries as soon as possible, this unit will not operate without battery power!

To deactivate this feature: Press the Test/Silence button again. The unit will go into test mode and the Low Battery Warning will require LED flashes and unit sounds "chirp" once a minute).

SILENCING THE END OF LIFE SIGNAL

This silence feature can temporarily quiet the End of Life warning "chirp" for up to 2 days. You can silence the End of Life warning "chirp" by pressing the Test/Silence button. The horn will chirp, acknowledging that the End of Life silence feature has been activated. After approximately 2 days, the End of Life "chirp" will resume.

AGENCY PLACEMENT RECOMMENDATIONS

Standards: Underwriters Laboratories Inc. Single and Multiple Station Smoke Alarms 217.

NFPA 72 CHAPTER 29 *FOR YOUR INFORMATION, THE NATIONAL FIRE ALARM AND SIGNALING CODE, NFPA 72, READS AS FOLLOWS:*

29.5.1.1* REQUIRED DETECTION.

29.5.1.1* Where required by other governing laws, codes, or standards for a specific type of occupancy, approved single and multiple-station smoke alarms shall be installed as follows:

- (1) "In all sleeping rooms and guest rooms
- (2) "Outside of each separate dwelling unit sleeping area, within 21 ft (6.4 m) of any door to a sleeping room, with the distance measured along a path of travel
- (3) On every level of a dwelling unit, including basements
- (4) On every level of a residential board and care occupancy (small facility), including basements and excluding crawl spaces and unfinished attics
- (5) "In the living areas) of a guest suite
- (6) In the living areas) of a residential board and care occupancy (small facility)

(Reprinted with permission from NFPA 72*, National Fire Alarm and Signaling Code Copyright © 2010 National Fire Protection Association, Quincy, MA 02269. This reprinted material is not the complete and official position of the National Fire Protection Association, on the referenced subject which is represented only by the standard in its entirety. (National Fire Alarm and Signaling Code" and NFPA 72* are registered trademarks of the National Fire Protection Association, Inc., Quincy, MA 02269).

CALIFORNIA STATE FIRE MARSHAL (CSFM)

Early warning detection is best achieved by the installation of fire detection equipment in all rooms and areas of the household as follows:
A smoke alarm installed in each separate sleeping area in the vicinity, but outside bedrooms, and heat or smoke alarms in the living rooms, dining rooms, bedrooms, kitchens, hallways, finished attics, furnace rooms, closets, utility and storage rooms, basements, and attached garages.

ABOUT SMOKE ALARMS

Battery (CO) operated smoke alarms: Provide protection even when electricity fails, provided the batteries are fresh and properly installed. (Units are easy to install, and do not require professional installation.

AC powered smoke alarms: Can be interconnected so if one unit senses smoke, all units alarm. They do not operate if electricity fails. AC with battery (CO) back-up will operate if electricity fails, provided the batteries are fresh and correctly installed. AC and AC/DC units must be installed by a qualified electrician.

Smoke/CO alarms for Solar or wind energy users and battery backup power systems: AC powered smoke/CO alarms should only be operated with true or pure sine wave inverters. Operating this alarm with most battery-powered UPS (uninterruptible power supply) products or square wave or "quasi sine wave" inverters will damage the alarm. If you are not sure about your inverter or UPS type, please consult with the manufacturer to verify.

Smoke alarms for the hearing impaired: Special purpose smoke alarms should be installed for the hearing impaired. They include a visual alarm and an audible alarm, and meet the requirements of the Americans With Disabilities Act. Can be interconnected so if one unit senses smoke, all units alarm.

Smoke alarms are not to be used with detector gears unless the combination has been evaluated and found suitable for that purpose.

All these smoke alarms are designed to provide early warning of fires if located, installed and cared for as described in the user's manual, and if smoke reaches the alarm. If you are unsure which type of smoke alarm to install, refer the National Fire Protection Association (NFPA) Standard 72 (National Fire Alarm and Signaling code and NFPA 101 (Life Safety Code), National Fire Protection Association, One Batterymarch Park, Quincy, MA 02269-3101. Local building codes may also require specific units in new construction or in different areas of the home.

WHAT YOU NEED TO KNOW ABOUT CO:

WHAT IS CO?

CO is an invisible, odorless, tasteless gas produced when fossil fuels do not burn completely, or are exposed to heat (usually fire). Electrical appliances typically do not produce CO.

These fuels include: Wood, coal, charcoal, oil, natural gas, gasoline, kerosene, and propane.

Common appliances are other sources of CO. If they are not properly maintained, are improperly ventilated, or malfunction, CO levels can rise quickly. CO is a real danger now that homes are more energy efficient. "Air-tight" homes with added insulation, sealed windows, and other weatherproofing can "trap" CO inside.

SYMPTOMS OF CO POISONING

These symptoms are related to CO POISONING and should be discussed with ALL household members.

Mild Exposure: Slight headache, nausea, vomiting, fatigue ("flu-like" symptoms).

Medium Exposure: Throbbing headache, drowsiness, confusion, fast heart rate.

Extreme Exposure: Convulsions, unconsciousness, heart and lung failure. Exposure to carbon monoxide can cause brain damage, death.

IMPORTANT!

This CO alarm measures exposure to CO over time. It alarms if CO levels are extremely high in a short period of time, or if CO levels reach a certain minimum over a long period of time. The CO alarm generally sounds an alarm before the onset of symptoms in average, healthy adults. Why is this important? Because you need to be warned of a potential CO problem while you can still react in time. In many reported cases of CO exposure, victims may be aware that they are not feeling well, but become disoriented and can no longer react well enough to exit the building or get help. Also, young children and pets may be the first affected. The average healthy adult might not feel any symptoms when the CO alarm sounds. However, people with cardiac or respiratory problems, infants, unborn babies, pregnant mothers, or elderly people can be more quickly and severely affected by CO. If you experience even mild symptoms of CO poisoning, consult your doctor immediately!

HOW CAN I PROTECT MY FAMILY FROM CO POISONING?

A CO alarm is an excellent means of protection. It monitors the air and sounds a loud alarm before carbon monoxide levels become threatening for average, healthy adults. A CO alarm is not a substitute for proper maintenance of home appliances.

TO HELP PREVENT CO PROBLEMS AND REDUCE THE RISK OF CO POISONING:

- Clean chimneys and flues yearly. Keep them free of debris, leaves, and nests for proper air flow. Also, have a professional check for rust and corrosion, cracks, or separations. These conditions can prevent proper air movement and cause backdrafting. Never "cap" or cover a chimney in any way that would block air flow.

- Test and maintain all fuel-burning equipment annually. Many local gas or oil companies and HVAC companies offer appliance inspections for a nominal fee.

- Make regular visual inspections of all fuel-burning appliances. Check appliances for excessive rust and scaling. Also check the flame on the burner and pilot lights. The flame should be blue. A yellow flame means fuel is not being burned completely and CO may be present. Keep the blower door on the furnace closed. Use vents or fans when they are available on all fuel-burning appliances. Make sure appliances are vented to the outside. Do not grill or barbecue indoors, or in garages or on screen porches.

- Check for exhaust backflow from CO sources. Check the draft hood on an operating furnace for a backdraft. Look for cracks on furnace heat exchangers.
- Check the house or garage on the other side of shared wall.
- Keep windows and doors open slightly. If you suspect that CO is escaping into your home, open a window or a door. Opening windows and doors can significantly decrease CO levels.

In addition, familiarize yourself with all enclosed materials. Read this manual in its entirety, and make sure you understand what to do if your CO alarm sounds.

When the smoke alarm is silenced	When the CO alarm is silenced
The smoke alarm will remain silent for up to 15 minutes, then return to normal operation.	The CO alarm will remain silent for up to 4 minutes.
If the smoke has not cleared—or continues to increase—the device will go back into alarm.	After 4 minutes, if CO levels remain potentially dangerous the horn will start sounding again.

SPECIAL COMPLIANCE CONSIDERATIONS

This smoke alarm is suitable for use in apartments, condominiums, townhouses, hospitals, day care facilities, health care facilities, boarding houses, group homes and dormitories providing a primary fire detection system already exists to meet fire detection requirements in common areas like lobbies, hallways, or porches. Using this smoke alarm in common areas may not provide sufficient warning to all residents or meet local fire protection ordinances/regulations.

This smoke alarm alone is not a suitable substitute for complete fire detection systems in places housing many people—like apartment buildings, condominiums, hotels, motels, dormitories, hospitals, health care facilities, nursing homes, day care facilities, or group homes of any kind. It is not a suitable substitute for complete fire detection systems in warehouses, industrial facilities, commercial buildings, and special-purpose non-residential buildings which require special fire detection and alarm systems. Depending on the building codes in your area, this smoke alarm may be used to provide additional protection in these facilities.

In new construction, most building codes require the use of AC or AC/DC powered smoke alarms only. In existing construction, AC, AC/DC, or DC powered smoke alarms can be used as specified by local building codes. Refer to NFPA 72 (National Fire Alarm and Signaling code) and NFPA 101 (Life Safety Code), local building codes, or consult your Fire Department for detailed fire protection requirements in buildings not defined as "households".

HUD MAP PROGRAM

Certain HUD battery powered smoke alarm applications, especially those that fall under HUD 2231) MAP (Multi-family Accelerated Processing), may require a 10-Year sealed tamper resistant battery. This alarm does not meet that requirement. Substitute First Alert SA340B.

FCC COMPLIANCE

This equipment has been tested and found to comply with the limits for a Class B digital device, pursuant to Part 15 of the FCC rules. These limits are designed to provide reasonable protection against harmful interference in a residential installation. This equipment generates, uses and can radiate radio frequency energy and, if not installed and used in accordance with the instructions, may cause harmful interference to radio communications.

However, there is no guarantee that the interference will not occur in a particular installation. If this equipment does cause harmful interference to radio or television reception, which can be determined by turning the equipment off and on, the user is encouraged to try to correct the interference by one or more of the following measures:

- Reorient or relocate the receiving antenna.
- Increase the separation between the equipment and receiver.
- Connect the equipment into an outlet on a circuit different from that of the receiver.
- Consult the dealer or an experienced radio or TV technician for help.

▲WARNING!

Changes or modifications to the product, not expressly approved by First Alert / BRK Brands, Inc., could void the user's authority to operate the equipment.

This device complies with Part 15 of the FCC Rules. Operation is subject to the following two conditions: (1) this device may not cause harmful interference, and (2) this device must accept any interference received, including interference that may cause undesired operation.

WHAT YOU NEED TO KNOW ABOUT CO:

WHAT IS CO?

CO is an invisible, odorless, tasteless gas produced when fossil fuels do not burn completely, or are exposed to heat (usually fire). Electrical appliances typically do not produce CO.

These fuels include: Wood, coal, charcoal, oil, natural gas, gasoline, kerosene, and propane.

Common appliances are other sources of CO. If they are not properly maintained, are improperly ventilated, or malfunction, CO levels can rise quickly. CO is a real danger now that homes are more energy efficient. "Air-tight" homes with added insulation, sealed windows, and other weatherproofing can "trap" CO inside.

SYMPTOMS OF CO POISONING

These symptoms are related to CO POISONING and should be discussed with ALL household members.

Mild Exposure: Slight headache, nausea, vomiting, fatigue ("flu-like" symptoms).

Medium Exposure: Throbbing headache, drowsiness, confusion, fast heart rate.

Extreme Exposure: Convulsions, unconsciousness, heart and lung failure. Exposure to carbon monoxide can cause brain damage, death.

IMPORTANT!

This CO alarm measures exposure to CO over time. It alarms if CO levels are extremely high in a short period of time, or if CO levels reach a certain minimum over a long period of time. The CO alarm generally sounds an alarm before the onset of symptoms in average, healthy adults. Why is this important? Because you need to be warned of a potential CO problem while you can still react in time. In many reported cases of CO exposure, victims may be aware that they are not feeling well, but become disoriented and can no longer react well enough to exit the building or get help. Also, young children and pets may be the first affected. The average healthy adult might not feel any symptoms when the CO alarm sounds. However, people with cardiac or respiratory problems, infants, unborn babies, pregnant mothers, or elderly people can be more quickly and severely affected by CO. If you experience even mild symptoms of CO poisoning, consult your doctor immediately!

HOW CAN I PROTECT MY FAMILY FROM CO POISONING?

A CO alarm is an excellent means of protection. It monitors the air and sounds a loud alarm before carbon monoxide levels become threatening for average, healthy adults. A CO alarm is not a substitute for proper maintenance of home appliances.

TO HELP PREVENT CO PROBLEMS AND REDUCE THE RISK OF CO POISONING:

- Clean chimneys and flues yearly. Keep them free of debris, leaves, and nests for proper air flow. Also, have a professional check for rust and corrosion, cracks, or separations. These conditions can prevent proper air movement and cause backdrafting. Never "cap" or cover a chimney in any way that would block air flow.

- Test and maintain all fuel-burning equipment annually. Many local gas or oil companies and HVAC companies offer appliance inspections for a nominal fee.
- Make regular visual inspections of all fuel-burning appliances. Check appliances for excessive rust and scaling. Also check the flame on the burner and pilot lights. The flame should be blue. A yellow flame means fuel is not being burned completely and CO may be present. Keep the blower door on the furnace closed. Use vents or fans when they are available on all fuel-burning appliances. Make sure appliances are vented to the outside. Do not grill or barbecue indoors, or in garages or on screen porches.

- Check for exhaust backflow from CO sources. Check the draft hood on an operating furnace for a backdraft. Look for cracks on furnace heat exchangers.
- Check the house or garage on the other side of shared wall.
- Keep windows and doors open slightly. If you suspect that CO is escaping into your home, open a window or a door. Opening windows and doors can significantly decrease CO levels.

In addition, familiarize yourself with all enclosed materials. Read this manual in its entirety, and make sure you understand what to do if your CO alarm sounds.

When the smoke alarm is silenced	When the CO alarm is silenced
The smoke alarm will remain silent for up to 15 minutes, then return to normal operation.	The CO alarm will remain silent for up to 4 minutes.
If the smoke has not cleared—or continues to increase—the device will go back into alarm.	After 4 minutes, if CO levels remain potentially dangerous the horn will start sounding again.

SILENCING THE LOW BATTERY WARNING

This silence feature can temporarily quiet the Low Battery Warning "chirp". Press the Test/Silence button on the alarm.

Once the Low Battery Warning "chirp" silence feature is activated, the unit continues to flash the Green light once a minute. After time, the low battery "chirp" will resume. Replace the batteries as soon as possible, this unit will not operate without battery power!

To deactivate this feature: Press the Test/Silence button again. The unit will go into test mode and the Low Battery Warning will require LED flashes and unit sounds "chirp" once a minute).

SILENCING THE END OF LIFE SIGNAL

This silence feature can temporarily quiet the End of Life warning "chirp" for up to 2 days. You can silence the End of Life warning "chirp" by pressing the Test/Silence button. The horn will chirp, acknowledging that the End of Life silence feature has been activated. After approximately 2 days, the End of Life "chirp" will resume.

AGENCY PLACEMENT RECOMMENDATIONS

Standards: Underwriters Laboratories Inc. Single and Multiple Station Smoke Alarms 217.

NFPA 72 CHAPTER 29 *FOR YOUR INFORMATION, THE NATIONAL FIRE ALARM AND SIGNALING CODE, NFPA 72, READS AS FOLLOWS:*

29.5.1.1* REQUIRED DETECTION.

29.5.1.1* Where required by other governing laws, codes, or standards for a specific type of occupancy, approved single and multiple-station smoke alarms shall be installed as follows:

- (1) "In all sleeping rooms and guest rooms
- (2) "Outside of each separate dwelling unit sleeping area, within 21 ft (6.4 m) of any door to a sleeping room, with the distance measured along a path of travel
- (3) On every level of a dwelling unit, including basements
- (4) On every level of a residential board and care occupancy (small facility), including basements and excluding crawl spaces and unfinished attics
- (5) "In the living areas) of a guest suite
- (6) In the living areas) of a residential board and care occupancy (small facility)

(Reprinted with permission from NFPA 72*, National Fire Alarm and Signaling Code Copyright © 2010 National Fire Protection Association, Quincy, MA 02269. This reprinted material is not the complete and official position of the National Fire Protection Association, on the referenced subject which is represented only by the standard in its entirety. (National Fire Alarm and Signaling Code" and NFPA 72* are registered trademarks of the National Fire Protection Association, Inc., Quincy, MA 02269).

CALIFORNIA STATE FIRE MARSHAL (CSFM)

Early warning detection is best achieved by the installation of fire detection equipment in all rooms and areas of the household as follows:
A smoke alarm installed in each separate sleeping area in the vicinity, but outside bedrooms, and heat or smoke alarms in the living rooms, dining rooms, bedrooms, kitchens, hallways, finished attics, furnace rooms, closets, utility and storage rooms, basements, and attached garages.

ABOUT SMOKE ALARMS

Battery (CO) operated smoke alarms: Provide protection even when electricity fails, provided the batteries are fresh and properly installed. (Units are easy to install, and do not require professional installation.

AC powered smoke alarms: Can be interconnected so if one unit senses smoke, all units alarm. They do not operate if electricity fails. AC with battery (CO) back-up will operate if electricity fails, provided the batteries are fresh and correctly installed. AC and AC/DC units must be installed by a qualified electrician.

Smoke/CO alarms for Solar or wind energy users and battery backup power systems: AC powered smoke/CO alarms should only be operated with true or pure sine wave inverters. Operating this alarm with most battery-powered UPS (uninterruptible power supply) products or square wave or "quasi sine wave" inverters will damage the alarm. If you are not sure about your inverter or UPS type, please consult with the manufacturer to verify.

Smoke alarms for the hearing impaired: Special purpose smoke alarms should be installed for the hearing impaired. They include a visual alarm and an audible alarm, and meet the requirements of the Americans With Disabilities Act. Can be interconnected so if one unit senses smoke, all units alarm.

Smoke alarms are not to be used with detector gears unless the combination has been evaluated and found suitable for that purpose.

All these smoke alarms are designed to provide early warning of fires if located, installed and cared for as described in the user's manual, and if smoke reaches the alarm. If you are unsure which type of smoke alarm to install, refer the National Fire Protection Association (NFPA) Standard 72 (National Fire Alarm and Signaling code and NFPA 101 (Life Safety Code), National Fire Protection Association, One Batterymarch Park, Quincy, MA 02269-3101. Local building codes may also require specific units in new construction or in different areas of the home.

FINDING THE SOURCE OF CO AFTER AN ALARM

Carbon monoxide is an odorless, invisible gas, which often makes it difficult to locate the source of CO after an alarm. These are a few of the factors that can make it difficult to locate sources of CO:

- House well ventilated before the investigator arrives.
- Problem caused by "backdrafting."
- Transient CO problem caused by special circumstances.

Because CO may dissipate by the time an investigator arrives, it may be difficult to locate the source of CO. BRK Brands, Inc. shall not be obligated to pay for any carbon monoxide investigation or service call.

POTENTIAL SOURCES OF CO IN THE HOME

Fuel-burning appliances like: portable heater, gas wood burning fireplace, gas kitchen range or cooktop, gas clothes dryer.

Damaged or insufficient venting: corroded or disconnected water heater vent pipe, leaking chimney

Improper use of appliance/device: operating a barbecue grill or vehicle in an enclosed area (like a garage or screened porch).

Transient CO Problems: "transient" or on-again-off-again CO problems can be caused by outdoor conditions and other special circumstances.

The following conditions can result in transient CO situations:

- Excessive spillage or reverse venting of fuel appliances caused by outdoor conditions such as:
 - Wind direction and/or velocity, including high, gusty winds. Heavy air in the vent pipes (cold/humid air with extended periods between cycles).
 - Negative pressure differential resulting from the use of exhaust fans.
 - Several appliances running at the same time competing for limited fresh air.
 - Vent pipe connections vibrating loose from clothes dryers, furnaces, or water heaters.
 - Obstructions in or unconventional vent pipe designs which can amplify the above situations.
 - Extended operation of unvented fuel burning devices (range, oven, fireplace).
 - Temperature inversions, which can trap exhaust close to the ground.
 - Car idling in an open or closed attached garage, or near a home.
- These conditions are dangerous because they can trap exhaust in your home. Since these conditions can come and go, they are also hard to recreate during a CO investigation.**



Fire Department: If you are unsure which type of smoke alarm to install, refer the National Fire Protection Association (NFPA) Standard 72 (National Fire Alarm and Signaling code and NFPA 101 (Life Safety Code), National Fire Protection Association, One Batterymarch Park, Quincy, MA 02269-3101. Local building codes may also require specific units in new construction or in different areas of the home.

GENERAL LIMITATIONS OF SMOKE/CO ALARMS

This smoke/CO alarm is intended for residential use. It is not intended for use in industrial applications where Occupational Safety and Health Administration (OSHA) requirements for carbon monoxide alarms must be met. The smoke alarm portion of this device is not intended to alert hearing impaired residents. Special purpose smoke alarms should be installed for hearing impaired residents (CO alarms are not yet available for the hearing impaired).

Smoke/CO alarms may not wakeen all individuals. Practice the escape plan at least twice a year, making sure that everyone is involved – from kids to grandparents. Allow children to master fire escape planning and practice before holding a fire drill at night when they are sleeping. If children or others do not readily wake to the sound of the smoke/CO alarm, or if there are infants or family members with mobility limitations, make sure that someone is assigned to assist them in fire drill and in the event of an emergency. It is recommended that you hold a fire drill while family members are sleeping in order to determine their response to the sound of the smoke/CO alarm while sleeping and to determine whether they may need assistance in the event of an emergency.

Smoke/CO alarms cannot work without power. Battery operated units cannot work if the batteries are missing, disconnected or dead, if the wrong type of batteries are used, or if the batteries are not installed correctly. AC units cannot work if the AC power is cut off for any reason (open fuse or circuit breaker, failure along a power line or at a power station, electrical fire that burns the electrical wires, etc.). If you are concerned about the limitations of battery or AC power, install both types of units.

This smoke/CO alarm will not sense smoke or CO that does not reach the sensors. It will only sense smoke or CO at the sensor. **Smoke or CO may be present in other areas.** Doors or other obstructions may affect the rate at which CO or smoke reaches the sensors. If bedroom doors are usually closed at night, we recommend you install an alarm device (Combination CO and smoke alarm, or separate CO alarms and smoke alarm) in each bedroom and in the hallway between them.

This smoke/CO alarm may not sense smoke or CO on another level of the home. Example: This alarm device, installed on the second level, may not sense smoke or CO in the basement. For this reason, one alarm device may not give adequate early warning. Recommended minimum protection is one alarm device in every sleeping area, every bedroom, and on every level of your home. Some experts recommend battery powered smoke and CO alarms be used in conjunction with interconnected AC powered smoke alarms. For details, see "About Smoke Alarms" for details.

Smoke/CO alarms may not be heard. The alarm horn loudness meets or exceeds current UL standards of 85 dB at 10 feet (3 meters). However, if the smoke/CO alarm is installed outside the bedroom, it may not wake up a sound sleeper or one who has recently used drugs or has been drinking alcoholic beverages. This is especially true if the door is closed or only partly open. Even persons who are awake may not hear the alarm horn if the sound is blocked by distance or closed doors. Noise from traffic, clerks, radio, television, air conditioner, or other appliances may also prevent alert persons from hearing the alarm horn. This smoke/CO alarm is not intended for people who are hearing impaired.

The alarm may not have time to alarm before the fire itself causes damage, injury, or death, since smoke from some fires may not reach the unit immediately. Examples of this include persons smoking in bed, children playing with matches, or fires caused by violent explosions resulting from escaping gas.

This smoke/CO alarm is not a substitute for life insurance. Though this smoke/CO alarm warns against increasing CO levels or the presence of smoke, BRK Brands, Inc. does not warrant or imply in any way that they will protect lives. Homeowners and renters must still insure their lives.

This smoke/CO alarm has a limited life. Although this smoke/CO alarm and all of its parts have passed many stringent tests and are designed to be as reliable as possible, any of these parts could fail at any time. Therefore, you must test this device weekly. The unit should be replaced immediately if it is not operating properly.

This smoke/CO alarm is not foolproof. Like all other electronic devices, this smoke/CO alarm has limitations. It can only detect smoke or CO that reaches the sensors. It may not give early warning of the source of smoke or CO if is in a remote part of the home, away from the alarm device.

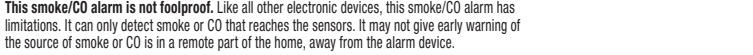

Fire Department: If you are unsure which type of smoke alarm to install, refer the National Fire Protection Association (NFPA) Standard 72 (National Fire Alarm and Signaling code and NFPA 101 (Life Safety Code), National Fire Protection Association, One Batterymarch Park, Quincy, MA 02269-3101. Local building codes may also require specific units in new construction or in different areas of the home.

FINDING THE SOURCE OF CO AFTER AN ALARM

Carbon monoxide is an odorless, invisible gas, which often makes it difficult to locate the source of CO after an alarm. These are a few of the factors that can make it difficult to locate sources of CO:

- House well ventilated before the investigator arrives.
- Problem caused by "backdrafting."
- Transient CO problem caused by special circumstances.

Because CO may dissipate by the time an investigator arrives, it may be difficult to locate the source of CO. BRK Brands, Inc. shall not be obligated to pay for any carbon monoxide investigation or service call.