

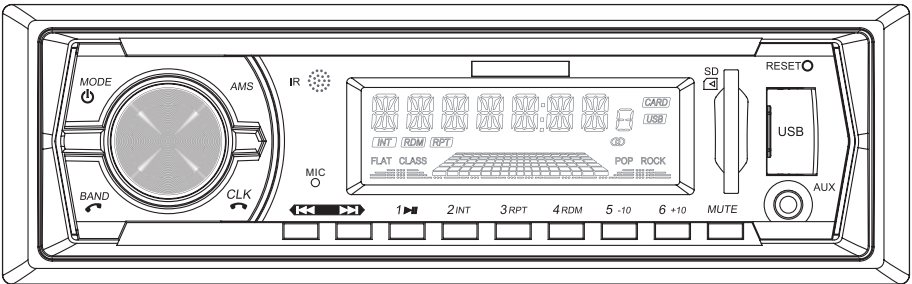

In-Dash AM/FM Receiver with MP3 Playback & USB/SD/AUX Inputs

Receiver Models: PLMRB29W/PLMRB29B



USER'S MANUAL



COTENTS

COTENTS	1
PRECAUTIONS	2
Precautions & Warnings	2
Lithium Battery Cell Warnings	2
Drives and connections	2
Others Warnings	2
INSTALLATION	3
Installation Procedures	3
Installation Opening	3
To Install the Car Radio	3
Wiring Connections	4
Removal of the Main Unit	4
CONTROL PANEL BUTTON LOACTIONS	5
GENERAL OPERATION	6
Turn Unit On/Off	6
Adjust Volume (VOL.)	6
Adjust Menu Options (SEL)	6
Set the Clock (CLK)	6
Change the Source (MODE)	7
Mute on/off	7
Loudness on/off	7
Preset Equalizer(EQ)	7
USB port	7
Built-in Microphone	7
Aux input connector	7
Reset System (RESET)	7
RADIO OPERATION	8
Switch Between USA area and Europe area Frequency	8
Change Bands (BAND)	8
Manual Tuning (◀◀ / ▶▶)	8
Auto Seek Tuning (◀◀ / ▶▶)	8
To Store / Recall Preset Stations	8
Automatic Store station/ Preset station scan (AMS)	8
LOCAL/DX	8
STEREO/MONO	8
USB / SD CARD OPERATION	9
To insert USB / SD CARD	9
Eject USB/SD	9
Play/Pause	9
Next/Previous Track	9
Fast Forward/Backward	9
Introduction Scan	9
Repeating the same track	9
Playing all tracks in random	9
Track/Folder Navigation	9
Select the track or file for playback in MP3 format	10
AUXILIARY INPUT OPERATION	10
BLUETOOTH OPERATION	11
Pair and Connect	11
Make a Call	11
Redial Last Dialed Number	11
Answer a Call	11
Reject a Call	11
End a Call	11
Switch Audio Between Car Audio and Mobile Phone	11
Adjust Talk Volume	11
Audio Streaming (A2DP)	11
REMOTE CONTROL	12
SPECIFICATIONS	13
TROUBLESHOOTING	14

PRECAUTIONS

Precautions & Warnings

- To reduce the risk of fire, electric shock, and interference, do not attempt to repair this unit yourself. Refer all service to a qualified technician.
- Some MP3/WMA files may not be playable.
- Keep the volume at a reasonable level to avoid distracted driving. High volume levels may make it difficult to concentrate on traffic and road conditions while driving.
- If the car has been in direct sunlight for an extended period, you may need to reduce the temperature inside the car before turning on and using the unit.
- If the battery is disconnected, discharged, or changed, the preset memory of the unit will be lost and require reprogramming.
- The unit is designed to be installed in a level, horizontal position.
For optimal performance, avoid installing the unit at an angle.
Do not tightly grip the display and buttons to avoid damage.

Lithium Battery Cell Warnings

- Cell leakage may cause damage to the remote control.
- Do not throw cells into as this may cause an explosion.
- Keep battery cells out of reach of children.

Drives and connections

Never place any foreign objects into the openings of the car radio (USB jack, card slot, AUX IN connection). Otherwise you might damage the slots and connections.

Others Warnings

Do not switch on the car radio for long periods of time when the motor is switched off. This could cause the car battery to discharge and the vehicle can no longer be started.

INSTALLATION

Installation Procedures

First complete the electrical connections and then check for correctness.

Installation Opening

This unit can be installed in any dashboard having an opening as shown the right figure.

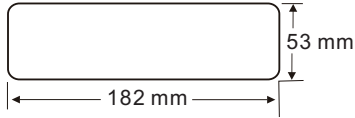

To Install the Car Radio

Be sure you test all connections first, and then follow these steps to install this unit.

1. Make sure the ignition is turned off, and then disconnect the cable from the vehicle battery's negative (-) terminal.
2. Disconnect the wire harness and the antenna.
3. Lift the left or right top corner of the plastic outer trim ring then pull it out to remove it.
4. Insert the two bracket keys into the left and right side of the chassis, as shown the below figure to separate the chassis from the housing.

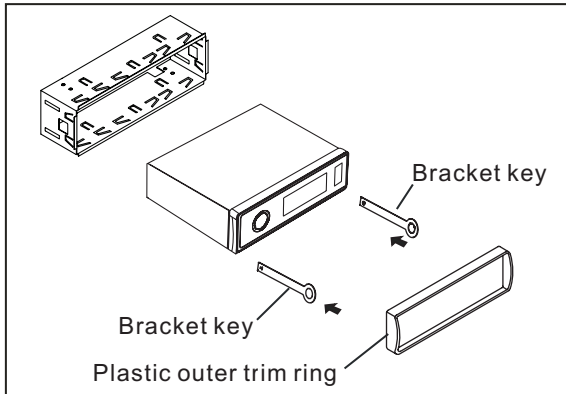

5. Insert mounting sleeve into the dashboard and bend the mounting tabs out with a screwdriver.
Make sure that the lock lever is flush with the mounting sleeve and is not projecting beyond.
6. Insert car radio into the mounting sleeve.
7. Use a metal strap to secure the rear part of the chassis using the hardware indicated.
8. Make wiring connections, as illustrated in the "Wiring Diagram."
9. Install the plastic outer trim ring.

Wiring Connections

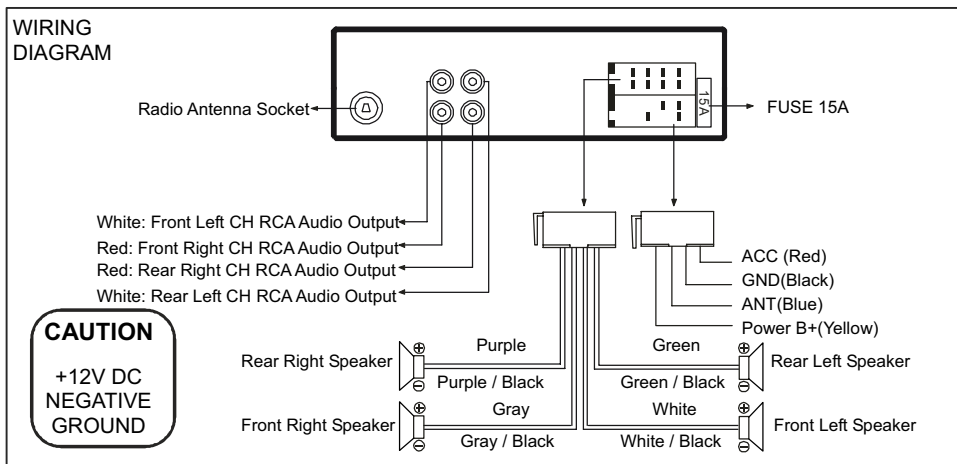

- Only use speakers with 4 ohms impedance.

- The maximum current of the auto antenna is 200mA.

Removal of the Main Unit

1. Remove the plastic trim out from the main unit.
2. Insert a bracket key into the left and right side of the main unit and draw the unit out of the mounting sleeve.

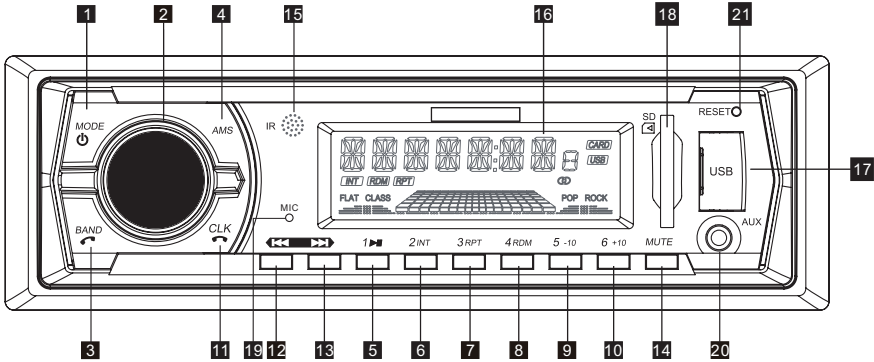

CONTROL PANEL BUTTON LOACTIONS



1. (power)/MODE (source) button
2. SEL (select/menu) button and VOL (volume) knob
3. BAND(button), button
4. AMS (automatic store / preset station scan, automatic music search) button
5. (pause/play), Preset station 1 button
6. INT (intro), Preset station 2 button
7. RPT (repeat), Preset station 3 button
8. RDM (random), Preset station 4 button
9. -10(previous 10 tracks), Preset station 5 button
10. +10(next 10 tracks), Preset station 6 button
11. CLK (clock setting) button, button
12. (tune down, seek down, track down, fast reverse) button
13. (tune up, seek up, track up, fast forward)button
14. MUTE button
15. IR remote control sensor
16. LCD Display
17. USB port
18. SD Card Slot
19. MIC hole(built-in Microphone)
20. AUX IN (auxiliary input) jack
21. RESET button

GENERAL OPERATION

Turn Unit On/Off

- Press the power () /**MODE** button on the front panel to turn on the unit, and long press it again to turn off the unit.
- Press the power () button on the remote control to turn the unit on or off.

Adjust Volume (VOL)

Rotate the **VOL** knob on the front panel or press the **VOL+ ▲/VOL- ▼** button on the remote control to increase or decrease the volume level.

Adjust Menu Options (SEL)

- Press the **SEL** button on the front panel or on the remote control repeatedly to cycle through the following adjustable audio functions: BASS, TREBLE, BALANCE, FADER, EQ FLAT/POP/ROCK/CLASS/OFF, LOUD ON/OFF, DX/LOC, STEREO/MONO and VOLUME.
- Rotate the **VOL** knob on the front panel or press the **VOL+ ▲/VOL- ▼** button on the remote control to adjust the selected item.
 - BASS:-07,-06, ~, -01,00,+01,~, +06,+07
 - TREBLE:-07,-06, ~, -01,00,+01,~, +06,+07
 - BALANCE:L07,L06,~, L01, 00, R01,~,R06,R07
 - FADER:R07,R06~,R01,00,F01,~,F06,F07
 - EQ(Equalizer) Setting: OFF, FLAT, POP, ROCK, CLASS
 - Loudness: LOUD ON/OFF
 - DX/LOCAL: Enables or disables the local broadcast mode (LOCAL).
 - Stereo/Mono: Switches between MONO and STEREO reception mode for radio frequencies.
 - Volume level:00, 01,~,43
- Press and hold the **SEL** button on the front panel or press the **SEL/ENTER** button on the remote control to access the AREA US/EU frequency switch mode.
 - AREA US/EU: This car radio is equipped the USA / Europe frequency.
Rotate the volume knob to switch between USA and Europe frequency.
The system will change the frequency setting in about 3 seconds.
- Rotate the **VOL** knob on the front panel or press the **VOL+ ▲/VOL- ▼** button on the remote control to adjust the selected item.

Set the Clock (CLK)

1. To display clock time, press the **CLK** button.
2. To set clock time, press and hold the **CLK** button and the hour will flash.
3. Press the **◀▶** or **▶▶** button on the front panel or on the remote control to adjust the hour.

4. Press the **CLK** button and the minutes will flash.
5. Press the **◀** or **▶** button on the front panel or on the remote control to adjust the minute.
6. Note: During Bluetooth mode, the clock can not be adjusted.

Change the Source (MODE)

Press the **MODE** button to switch between RADIO, BT(Bluetooth) , USB(with USB device inserted), CARD(with SD card inserted) and AUX-IN(auxiliary input) modes.

Mute on/off

In power on mode, briefly press the **MUTE** button to toggle mute on or off. The muted state will be also released when the volume knob is used.

Loudness on/off

Press the **LOUD** button on the remote control to turn on the loudness to reinforce the output of bass frequencies, press again to turn it off.

Preset Equalizer(EQ)

Press the **EQ** button on the remote control to toggle between EQ OFF, FLAT, POP, ROCK, CLASS.

USB port

The USB port of this car radio is designed for media playback from flash memory devices.

Built-in Microphone

To receive your voice when you calling by using this Bluetooth hands-free system.

Aux input connector

The 3.5mm auxiliary input stereo connection is designed for devices with 3.5mm line-out or headphone output.

Reset System (RESET)

The RESET button is used to reset all parameters to factory default settings.

This function may be used when the LCD does not display normally or sound is distorted, or when any of the controls are disabled. Use a thin object with a pointed end to depress the RESET button.

RADIO OPERATION

Switch Between USA area and Europe area Frequency

In radio mode, press and hold the **VOL/SEL** button to enter switch state of the US(USA) and EU (Europe) frequency, then rotate it to switch between US(USA) and EU(Europe) frequency. The system will change the frequency setting in about 3 seconds.

Change Bands (BAND)

Press the **BAND** button to switch between the FM1, FM2, FM3, AM1 and AM2 bands. Each band stores up to six preset stations.

Manual Tuning (◀◀ / ▶▶)

Press and hold the ▶▶ or ◀◀ button on the front panel or on the remote control to enter manual tuning mode. In manual tuning mode, press the ▶▶ or ◀◀ button to move the radio frequency number up or down one step.

Auto Seek Tuning (◀◀ / ▶▶)

In standby mode or while not in manual tuning mode, quickly press the ◀◀ or ▶▶ button to move to the next/previous available station automatically.

To Store / Recall Preset Stations

The radio can be stored 6 preset stations for each band (FM1, FM2, FM3, AM1 and AM2) for a total of 30 preset stations.

- To memorize a station:

- Turn the radio on and select the desired band and station.
- Select a station by ◀◀ or ▶▶ button.
- Press and hold the desired preset button (numbered 1-6 on the face of the radio) for more than 2 seconds to save the station to that preset number.

- To recall a preset station:

- Select the desired band.
- Briefly press a preset button (numbered 1-6) to recall the corresponding preset station.

Automatic Store station/ Preset station scan (AMS)

Press and hold the **AMS** button for more than 2 seconds to select six strong stations and store them in the current band. The radio will automatically scan the current frequency and enter the six strongest stations into the preset memory positions for that band.

Briefly press the **AMS** button on the remote control to recall each preset station that saved in the memories in each band.

LOCAL/DX

In urban areas, most stations are strong enough and "LOCAL ON" mode should be selected.

Switch to LOCAL OFF mode to search for stations with weaker signals.

Press the **LOC** button on the remote control to choose local or distant reception mode.

STEREO/MONO

FM station is received in stereo mode. However, if the signal is weak or reception is not as good as you would like, switching to MONO mode usually improves the overall sound quality.

Press the **ST** button on the remote control to choose FM STEREO or MONO audio effect.

USB / SD CARD OPERATION

To insert USB / SD CARD

- To play files on a USB device, open the USB port cover and insert the USB storage device into the USB port. Playback will begin automatically.
- Insert the SD card into the SD slot on the chassis. Playback will begin automatically.

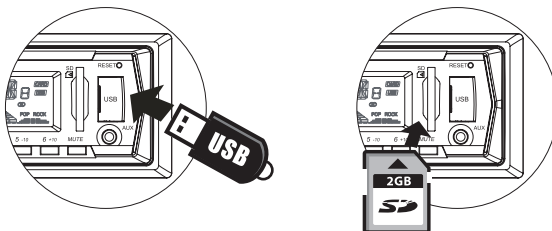

Eject USB/SD

- To eject a USB device, press the **▶||** button to stop playback, then remove the USB device.
- To eject an SD card, press the **▶||** button to stop playback, and push the SD card in the slot, then remove the SD card from the chassis.

Play/Pause

Press the **▶||** (play/pause) button to pause or resume playback.

Next/Previous Track

- To play the next track, press the **▶▶** button.
- To play the previous track, press the **◀◀** button.

Fast Forward/Backward

- To fast forward, press and hold the **▶▶** button.
- To fast backward, press and hold the **◀◀** button.

Introduction Scan

Press the **INT** button to play the first 10 seconds of each track, press again to stop the introduction scan, and play the current track.

Repeating the same track

Press the **RPT** button to repeat the current track, press again to stop repeat playback and resume normal playback.

Playing all tracks in random

Press the **RDM** button to play all tracks in random order, press again to cancel this function.

Track/Folder Navigation

- During a disc, USB or SD card mode, press the **5/-10** button to go backward 10 tracks.
Press the **6/+10** button to jump forward 10 tracks.
- During a MP3 disc, USB or SD card mode, press and hold the **5/-10** button to go back the previous folder.
Press and hold the **6/+10** button to go to the next folder.
You can repeat this function depending on the number and level of folders.
- These buttons have no this function if the USB device or SD card has no folders.

Select the track or file for playback in MP3 format

- a) In playback of files with MP3 format, press the AMS button to enter track search mode which allow you to quickly find a specific MP3 track or file by its serial number, and the "TRK SCH" and "T ---" will appear on the LCD display in sequence.
- b) Rotate the VOL knob to select the serial number of your favorite song with high speed.
- c) After selecting the desired serial number of your favorite song, press the SEL button to confirm and search. The track will be played immediately when the number is matched.

e.g. :

To listen to the 123rd song:

- a) Rotate the VOL knob to select the "1" on the ones place, 2 seconds later, the "1" will skip to tens place.
- b) Rotate the VOL knob to select the "2" on the ones place, 2 seconds later, the "1" and "2" will skip to hundreds and tens place.
- c) Rotate the VOL knob to select the "3" on the ones place.
- d) Finally press the SEL button to search and play the 123rd song.

AUXILIARY INPUT OPERATION

This car radio has an external auxiliary input jack, it is compatible with audio output from an MP3 music player. So you can listen to sounds and music from external devices, if you have plugged such a player into the AUX IN jack with a audio cable. Press the **MODE** button to switch to the AUX input mode on or off.

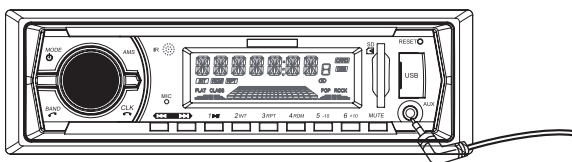



BLUETOOTH OPERATION

Pair and Connect

Prior to using the Bluetooth device as a hands-free system for a Bluetooth-enabled mobile phone for the first time, you must pair and connect the two devices as follows:

1. In any mode, prior to pairing and connecting, the BT logo in the LCD indicating that no device is connected. To begin pairing, enable BT mode on your mobile phone.
2. When the phone finds the car audio system, the "PYLE" name will be displayed.
3. Choose the "PYLE" from the device list to pair and connect with the car audio system. Upon confirming, the BT logo will stop flashing.
4. When pairing is complete, the mobile phone audio will automatically transfer to the car audio system whenever a call is made or received, or when the mobile phone plays music.

Make a Call

- To make a call, dial the call directly from the paired mobile phone.
- To make a call with this bluetooth hands-free system:
 - a) When linking up the Bluetooth-enabled mobile phone to this bluetooth hands-free system, press the  button to access the dial telephone number mode, then press the "0~9", * and # button on remote control to input the telephone number, and the entered number will be shown on the LCD display.
 - b) If a number has been incorrectly inputted, press the **DEL** button or  button to delete it.
 - c) Press the  button to make outgoing call.

Redial Last Dialed Number

Press and hold the  button on the control panel to redial the last dialed phone number.

Answer a Call

- When the mobile phone is called, the incoming telephone number displays on the LCD.
- To receive the call, press the  button on the control panel.

Reject a Call

To reject the call, press the  button on the control panel.

End a Call

To end an active call, press the  button.





Switch Audio Between Car Audio and Mobile Phone

During a call, press the **VOL** knob/button to switch the audio source from the car audio system back to your mobile phone.

Adjust Talk Volume

- During a call, use **VOL** knob or **VOL+** ▲ /**VOL-** ▼ button to adjust the volume level.
- Use the **MUTE** button to mute sound.

Audio Streaming (A2DP)

1. Press the  /**MODE** button to enter BT mode and display pause in the LCD display.
2. When a mobile device is paired, music played through that device will automatically be heard through the car audio system.
3. Press the  or  button to play the next or previous on the mobile phone.
4. Press the  button to pause or resume music playback.

REMOTE CONTROL

Remove Insulating Sheet

The remote control comes with an insulating sheet attached to the underside of the remote control, as illustrated on the right. The remote control will not work until the insulating sheet is removed.

Replace Lithium Battery Cell

1. When the lithium cell battery becomes weak, replace it as illustrated on the right.
2. Press and hold the movable block in the direction indicated by arrow 1. At the same time, pull the cell holder out of the remote control in the direction indicated by arrow 2.
3. Replace the old cell with a new one, making sure the (+) polarity is facing upward.
4. Re-insert the cell holder into the remote control.

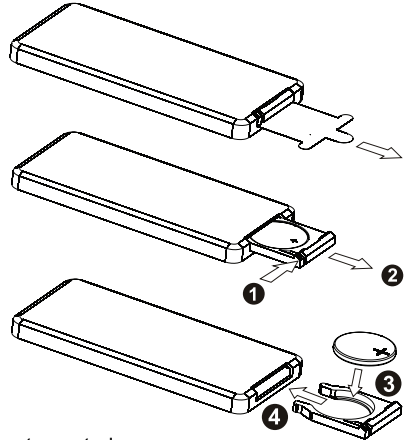

- Cell leakage may cause damage to the remote control.
- Do not throw cells into as this may cause an explosion.
- Keep battery cells out of reach of children.

Remote Control Operation

Position the emitting window of the remote control toward the sensor window of the unit.

- The operation angle for front panel remote control reception is about 30 degrees.
- The distance between the emitting window of the remote control and the sensor window of the unit should remain less 5 meters.

Button Names and Locations

1. (Power on/off) button
2. VOL+/VOL-(volume increase/decrease) button
3. Band button, (answer call) button
4. button: Tune down, seek down; Track down, fast reverse
5. SEL(selection) button
6. button: Tune up, seek up; Track up, fast forward
7. Mute button, DEL(Delete) button
8. CLK(clock setting) button, (end call) button
9. button, preset station 1 button, keypad 1
10. INT(intro) button, preset station 2 button, keypad 2
11. RPT(repeat) button, preset station 3 button, keypad 3
12. RDM (random), preset station 4 button, keypad 4
13. -10(previous 10 tracks), preset station 5 button, keypad 5
14. +10(next 10 tracks), preset station 6 button, keypad 6
15. ST (stereo) button, keypad 7
16. LOUD(loudness) button, keypad 8
17. AMS (automatic music search) button, keypad 9
18. MODE button, keypad *
19. EQ(Equalizer) button, keypad 0
20. LOC (local)/DX button, keypad #

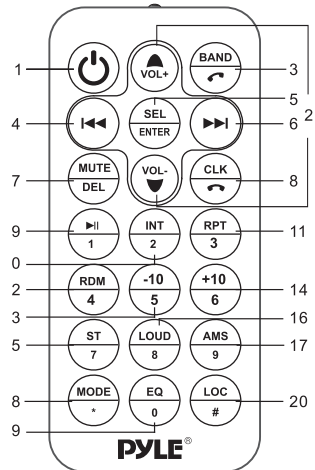

Note: When using the remote control for the first time, you must pull out the protective plastic tab from the battery compartment found on the back of the remote control.

SPECIFICATIONS

General

Chassis Dimensions.....	178(W) x 160(D) x 50(H) mm
Power Supply Requirement	DC 12V
Current Consumption15A (max.)
Maximum Power Output75W x 4CH

Radio

FM

USA/ Europe Frequency Range.....	87.5 - 107.9 MHz (200KHz/Step)
	87.5 - 108.0 MHz(50KHz/Step)

Usable Sensitivity	30 dBu
I.F. Frequency	10.7 MHz

AM

USA/ Europe Frequency Range.....	530 - 1710KHz (10KHz/Step)
	522 - 1620 KHz (9KHz/Step)

Usable Sensitivity	20 dBu
I.F. Frequency	450 KHz

USB/Card

Usable Audio Formats	MP3/WMA
Pre-amp Output	Front and Rear
Frequency Response20 Hz - 20 KHz
S/N Ratio	60dB

BT

BT Profile supports	A2DP, AVRCP, HSP, HFP
Range of frequency	2.4GHz spectrum

TROUBLESHOOTING

If you suspect something is wrong, immediately switch power off. Do not use the unit in abnormal condition, for example without sound, or with smoke or foul smell, can cause fire or electric shock.

Immediately stop using it and call the store where you purchased it. Never try to repair the unit by yourself because it is dangerous to do so.

■ General

- 1) Car's engine switch is not on.
 - Turn you car's key to ACC or ON.
- 2) Cable is not correctly connected.
 - Check the connection.
- 3) Fuse is burnt.
 - Replace fuse.
- 4) Volume is in mute or minimum.
 - Check volume or mute on/off, adjust volume to a desired level.
- 5) Sound skips.
 - The installation angle is more than 30°. Adjust the installation angle less than 30°.
- 6) The operation keys do not work.
 - The built-in micro- computer is not operating properly due to noise. Press the RESET button to restore the program to zero.

■ Radio

- 1) Much noise in broadcasts.
 - Station or signal is too weak. Select other stations of stronger signal level.
- 2) The antenna cable is not connected.
 - Insert the antenna cable firmly into the antenna socket of this car radio.
- 3) Preset station is reset.
 - Battery cable is not correctly connected. Connect the battery cable to the terminal that is always live.

■ USB/SD

USB or SD card is connecting but no sound

- USB or SD card connection is not good. Take it out and insert again.
- USB or SD card is damaged or no music file inside. Change to another USB or SD card, or record music inside it.