



Mini Projector

User's Guide for Model PJ609B v2294-01

For the most up-to-date version of this User's Guide, go to www.gpx.com

Safety Instructions & Warnings

Important Safety Instructions

- Read these Instructions.
- Keep these Instructions.
- Heed all Warnings.
- Follow all instructions.
- Do not use this apparatus near water.
- Clean only with a dry cloth.
- Do not block any ventilation openings. Install in accordance with the manufacturer's instructions.
- Do not install near any heat sources such as radiators, heat registers, stoves, or other apparatus (including amplifiers) that produce heat.
- Do not defeat the safety purpose of the polarized or grounding - type plug. A polarized plug has two blades with one wider than the other. A grounding type plug has two blades and a third grounding prong. The wide blade or the third prong are provided for your safety. When the provided plug does not fit into your outlet, consult an electrician for replacement of the obsolete outlet.
- Protect the power cord from being walked on or pinched particularly at plugs, convenience receptacles, and the point where they exit from the apparatus.
- Only use attachments/accessories specified by the manufacturer.
- Unplug this apparatus during lightning storms or when unused for long periods of time.
- Refer all servicing to qualified service personnel. Servicing is required when the apparatus has been damaged in any way, such as power-supply cord or plug is damaged, liquid has been spilled or objects have fallen into the apparatus, the apparatus has been exposed to rain or moisture, does not operate normally, or has been dropped.
- Use only with a cart, stand, tripod, bracket, or table specified by the manufacturer, or sold with the apparatus. When a cart is used, use caution when moving the cart/apparatus combination to avoid injury from tip-over.



FCC Warnings

Warning: Changes or modifications to this unit not expressly approved by the party responsible for compliance could void the user's authority to operate the equipment.

NOTE: This equipment has been tested and found to comply with the limits for a Class B digital device, pursuant to Part 15 of the FCC Rules. These limits are designed to provide reasonable protection against harmful interference in a residential installation. This equipment generates, uses, and can radiate radio frequency energy and, if not installed and used in accordance with the instructions, may cause harmful interference to radio communications. However, there is no guarantee that interference will not occur in a particular installation. If this equipment does cause harmful interference to radio or television reception, which can be determined by turning the equipment off and on, the user is encouraged to try to correct the interference by one or more of the following measures:

- Reorient or relocate the receiving antenna.
- Increase the separation between the equipment and receiver.
- Connect the equipment into an outlet on a circuit different from that to which the receiver is connected.
- Consult the dealer or an experienced radio/TV technician for help.

Battery Warnings

- WARNING: Do not ingest battery, Chemical Burn Hazard.
- If the remote control supplied with this product contains a coin/button cell battery and the coin/button cell battery is swallowed, it can cause severe internal burns in just 2 hours and can lead to death.
- Keep new and used batteries away from children. If the battery compartment does not close securely, stop using the product and keep it away from children.
- If you think batteries might have been swallowed or placed inside any part of the body, seek immediate medical attention.
- CAUTION: Danger of explosion if battery is incorrectly replaced. Replace only with the same or equivalent type.
- WARNING: There is a danger of explosion if you attempt to charge standard Alkaline batteries in the unit. Only use rechargeable NiMH batteries.
- Battery shall not be exposed to excessive heat such as sunshine, fire, or the like.
- Do not mix old and new batteries.
- Completely replace all old batteries with new ones.
- Do not mix alkaline, standard (carbon-zinc), or rechargeable (ni-cad, ni-mh, etc) batteries.
- Batteries should be recycled or disposed of as per state and local guidelines.

Additional Warnings and Precautions

- Do not look directly into the projector light.
- Use in well ventilated area with ambient temperature between 41°F~104°C (5°C~40°C).
- Do not block any ventilation openings.
- To prevent risk of overheating, place the projector in an area that does not block ventilation, such as an enclosure or cabinet that might restrict airflow.
- Do not place the projector on an unstable surface, such as a loose stack of books, bed, or cushion.
- Do not cover the projector with a blanket, curtain, or similar.
- If setting up near a wall, leave at least 10 in. (25cm) between the wall and the projector's ventilation ports.
- Use a power outlet that can be easily accessed and unplugged.
- Do not block the light coming out of the lens. The light will heat the object and may cause burns, cause it to melt or catch fire.
- When powering off the projector, allow the cooling cycle to finish before handling or disconnecting the power supply.
- Do not use the projector if it has been damaged. Damage could be (but not limited to):
 - Unit has been dropped or something has been dropped on it or into it.
 - Something is loose or rattling inside the unit.
 - Projector has been exposed to rain or liquid.
 - Power supply or power cord is damaged.
- Do not use the projector in places where flammable gases or explosives may be present.
- Do not use the projector in the following conditions:
 - Extremely hot, cold, or humid environments
 - Environments with excessive amounts of dust and dirt in the atmosphere.
 - Near appliances generating a strong electromagnetic field or heat.
 - In direct sunlight.

- If the air vents become clogged or dirty, use a vacuum or air compressor and nozzle to clean. Do not use canned air, as the gas may leave a residue inside the enclosure.
- **CAUTION: TO PREVENT ELECTRIC SHOCK, MATCH WIDE BLADE OF PLUG TO WIDE SLOT, FULLY INSERT.**
- Mains plug is used as disconnect device and it should remain readily operable during intended use. In order to disconnect the apparatus from the mains completely, the mains plug should be disconnected from the mains socket outlet completely.
- **CAUTION:** Use of controls or adjustments or performance of procedures other than those specified may result in hazardous radiation exposure.
- **WARNING:** Changes or modifications to this unit not expressly approved by the party responsible for compliance could void the user's authority to operate the equipment.
- **WARNING:** Use of this unit near fluorescent lighting may cause interference regarding use of the remote. If the unit is displaying erratic behavior move away from any fluorescent lighting, as it may be the cause.
- **WARNING:** Shock hazard - Do Not Open.
- Caution and marking information is located at the rear or bottom of the apparatus.
- **WARNING:** To reduce the risk of fire or electric shock, do not expose this apparatus to rain, moisture, dripping, or splashing.
- Objects filled with liquids, such as vases, shall not be placed on the apparatus.
- Do not place any objects, heavy or otherwise, on the projector.
- This product meets and complies with all Federal regulations.
- See projector enclosure for related safety markings.
- No user serviceable parts inside, do not attempt to open the unit or perform any repair. Doing so may cause damage or injury, and will void your warranty.
- Refer all repairs or replacement to qualified service personnel.
- Stop using the projector and unplug the power source immediately if you notice the following:
 - Smoke coming from the unit or power supply.
 - Strange odors or noises coming from the unit.
 - Liquid or foreign objects have gotten inside the unit.
 - Unit has been dropped and enclosure has been damaged.



WARNING: To reduce the risk of electric shock, do not remove cover (or back). No user-serviceable parts inside. Refer servicing to qualified service personnel.



The exclamation point within an equilateral triangle is intended to alert the user to the presence of important operating and maintenance (servicing) instructions in the literature accompanying the appliance.



The lightning flash with arrowhead symbol, within an equilateral triangle, is intended to alert the user to the presence of un-insulated "dangerous voltage" within the product's enclosure that may be of sufficient magnitude to constitute a risk of electric shock to persons.



This symbol indicates that this product incorporates double insulation between hazardous mains voltage and user accessible parts.



WARNING : This product can expose you to chemicals including lead, which is known to the State of California to cause cancer and birth defects or other reproductive harm. For more information go to www.P65Warnings.ca.gov.

Table of Contents

Overview

Features - 5

Includes - 5

Projector

Features & Inputs - 6

Remote

Functions - 8

Batteries - 8

Menu Options

Picture Menu - 9

Sound Menu - 10

Options Menu - 11

Projector Setup

Power - 12

Projector Placement - 12

Angle Adjustment - 12

Viewing Options - 13

Image Adjustment - 13

Ceiling Mount - 14

Connecting to Other Devices

Pairing to Bluetooth Wireless Speakers or Sound Bar - 15

HDMI - 15

Audio/Video Input - 16

Computer Video (VGA) - 17

External Audio - 18

MicroSD & USB Storage Devices - 18

Customer Support

Contact Information - 19

Warranty - 19

International Support - 19

Overview

Features

- Supports 480p, 720p, 1080i, 1080p
- Native Resolution: 1280 x 720 (720p)
- Aspect Ratio: 16:9, 4:3 LB
- Brightness : 150 ANSI lumens
- Bluetooth wireless
- I/O: 2 x HDMI, VGA PC, USB, MicroSD card, AV, 3.5mm Headphone Jack
- 30" to 150" viewable screen size
- Display distance: 3.3-16.4 ft. (1-5m)
- Built-in speaker
- Keystone angle correction and focus adjust
- Ceiling mountable (hardware not included)

Includes

- Remote control: requires 2 AAA batteries (not included)
- 3.5mm to 3 x RCA audio/video cable
- AC/DC power adapter
- User's Guide

Projector

Features & Inputs

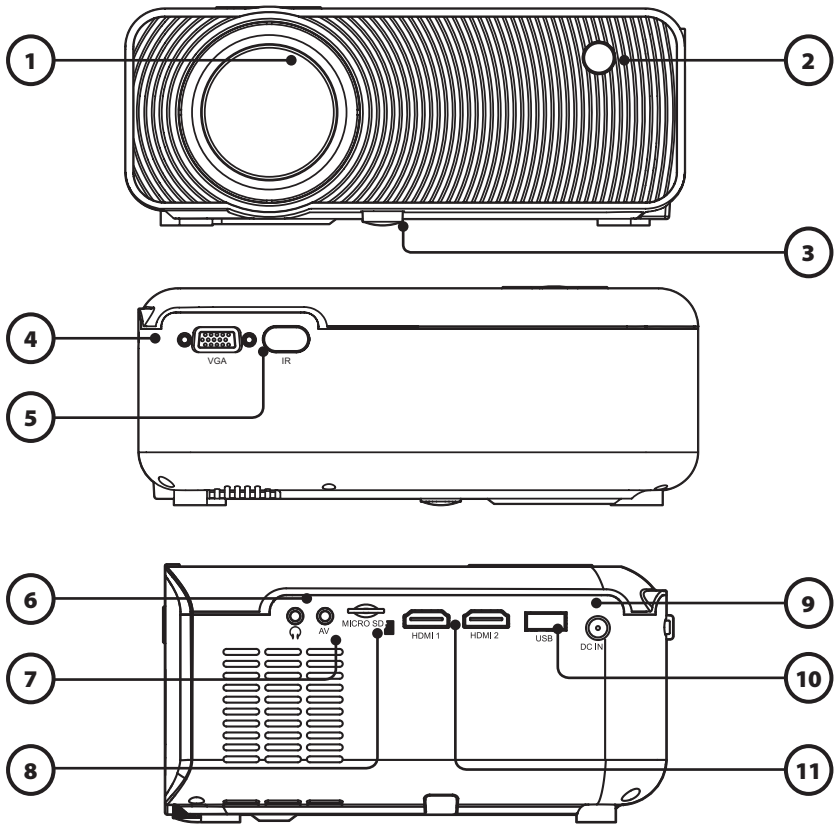

- | | |
|--------------------------|---------------------------|
| 1. Projector Lens | 8. MicroSD Card Port |
| 2. Front Remote Sensor | 9. DC Power Port |
| 3. Angle Adjustment Knob | 10. USB Port |
| 4. PC VGA Input | 11. HDMI Input 1 & 2 |
| 5. Rear Remote Sensor | 12. Focus Adjustment |
| 6. 3.5mm Audio Output | 13. Keystone Adjustment |
| 7. 3.5mm AV Input | 14. Controls & Indicators |

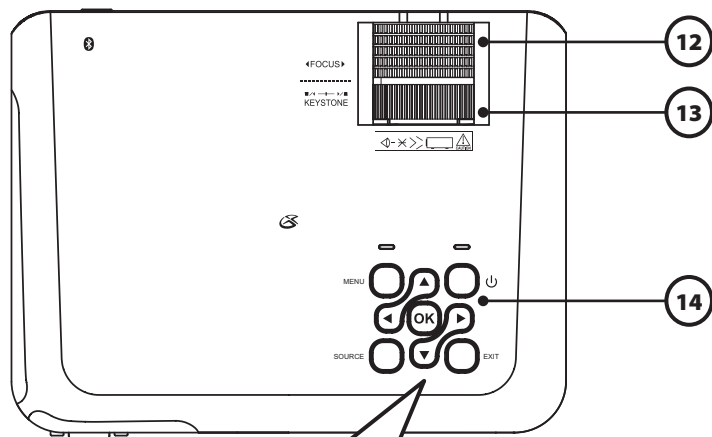

Menu
Press to access on-screen menu(s) and options.

Source
Press to change media source mode.

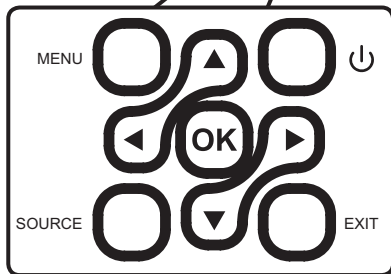

Arrows/OK
Press to navigate on-screen menu(s) and make selections.

Power
Press to power on the projector.
Press and hold to power OFF.

Exit
Press to return to a previous page or setting in the on-screen menu(s).

Remote

Functions

- Power**
Press to power ON.
Press to power OFF.
- ◀◀ Previous / Next ▶▶**
Press to skip between chapters or tracks.
- Stop**
Press to stop playback.
- Flip**
Press to flip display image 180°.
- ▶|| Play/Pause**
Press to play or pause an individual chapter or track.
- Arrows/OK**
Press to navigate and confirm selections in Settings and other menu(s).
- Menu**
Press to access projector Settings.
- Go To/Number Keypad**
Press to enter specific chapter or track numbers. Press Play when ready.

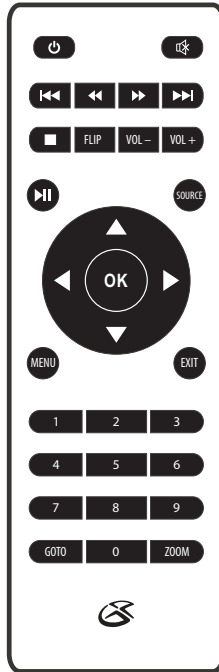

- Mute**
Press to mute volume.
- ◀◀ Back / Fwd ▶▶**
Press to search through an individual chapter or track.
- Vol + / Vol -**
Press to adjust audio level.
- Source**
Press to select media source (AV, PC, HDMI, MEDIA).
- Exit**
Press to exit menu(s).
- Zoom**
Press to zoom display image in or out.

Batteries

Requires 2 AAA batteries (not included).

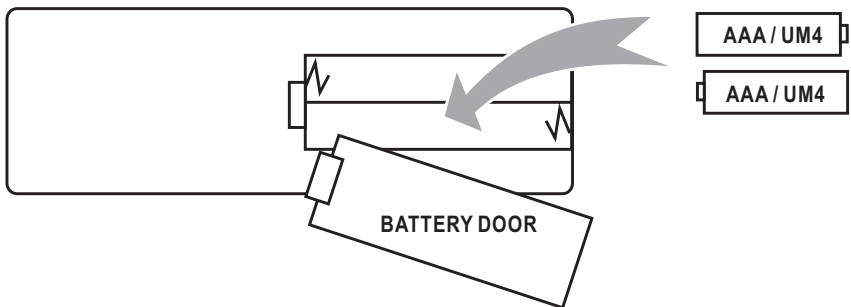

Menu Options

Change projector settings by pressing the Menu button and selecting the Setup icon.

Note: Not all settings are user adjustable.

Picture Menu

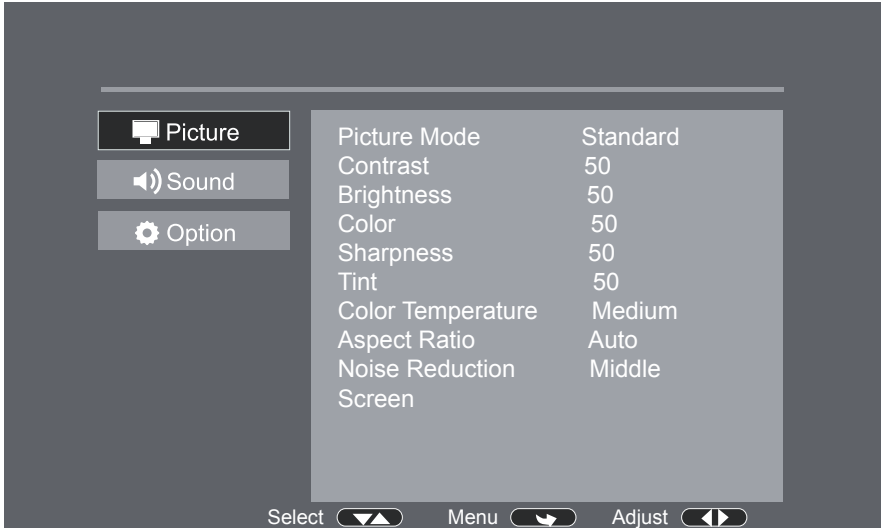

1. Picture Mode

Select Vivid, User (custom), Soft, or Standard.

2. Contrast, Brightness, etc.

Set Picture Mode to "User" to adjust these settings.

3. Color Temperature

Select Warm, Cool, or Medium.

4. Aspect Ratio

Select 16:9, 4:3, or Auto.

Menu Options

Sound Menu

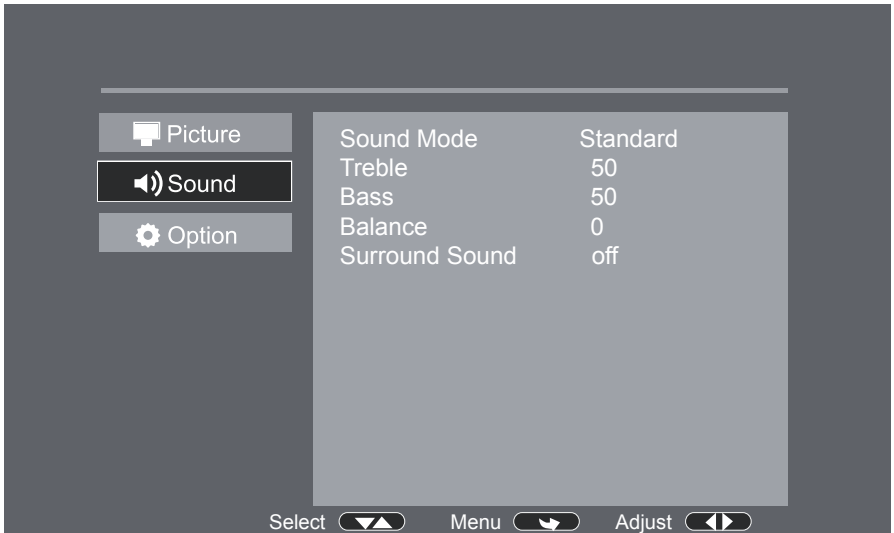

1. Sound Mode

Select Music, Movie, User (custom), Sports, or Standard.

2. Treble & Bass

Set Sound Mode to "User" to adjust these settings.

3. Balance

Adjust the audio balance.

4. Surround Sound

Turn Surround Sound ON or OFF.

Options Menu

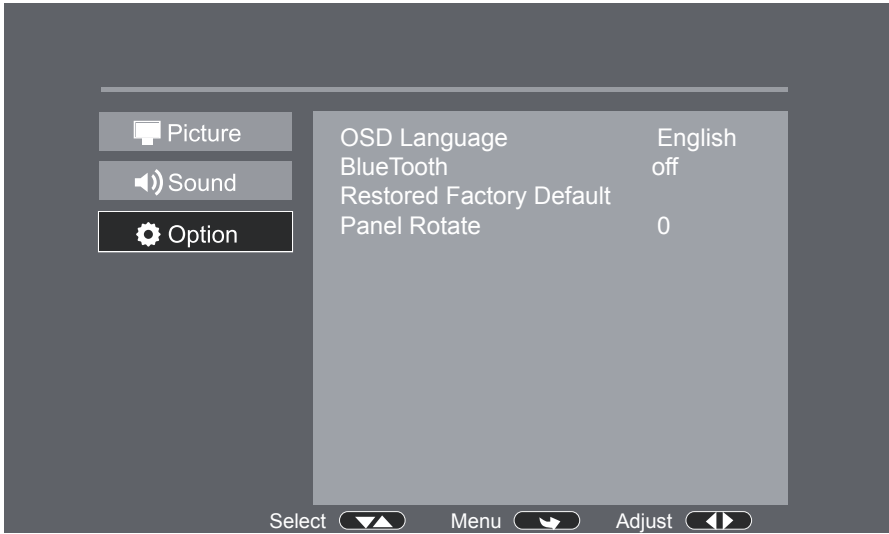

1. **OSD Language**

Select English, French, or Spanish for the On Screen Display.

2. **Bluetooth**

Turn Bluetooth ON or OFF.

3. **Restore Factory Default**

Reset the projector and restore all of the default settings.

4. **Panel Rotate**

Flip and mirror the screen image.

Projector Setup

Power

Plug the AC/DC power adapter (included) into a standard wall outlet and the DC power input on the rear of the unit. After connecting power, please allow approximately 5 seconds to pass before powering the unit ON.

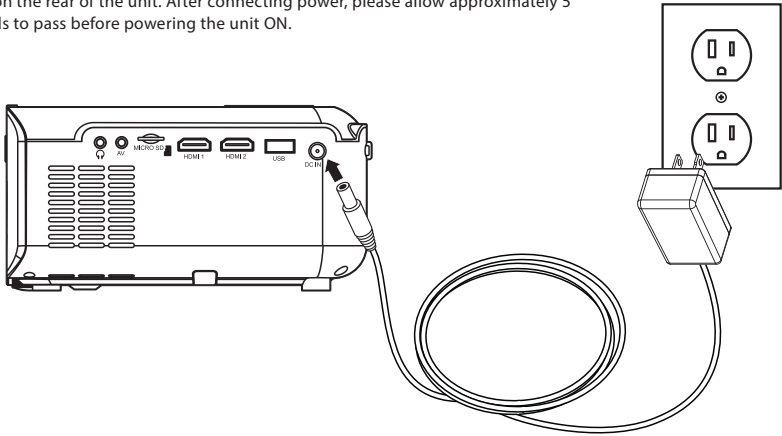

Projector Placement

For best results, place the projector in a dark room or other dimly lit area. The projector will display a screen size from 30" to 150". Adjust the projector angle and distance to best suit your needs.

Use the unit with a dedicated projector screen for best picture resolution. If placing the projector behind the viewing screen (unit in front of/projecting toward viewers), a special screen will be required. Projector screens are not included. If you are not using the unit with a screen, a smooth, white or lightly colored surface will provide the best results.

Angle Adjustment

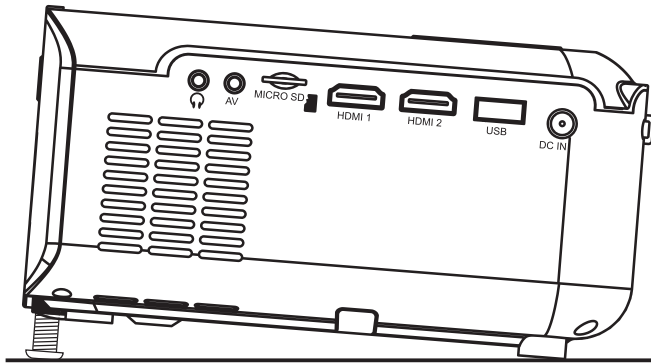

Use the Angle Adjustment Knob to fine tune the projector's height.

Viewing Options

The projector can be used to project onto a wall or screen. It can be mounted from a ceiling or placed on a table. Be sure to aim the remote at the sensor on the front or rear of the projector. See page 6 for sensor locations on the projector. When projecting from the rear position, a special screen will be needed (not included) to display the image.



FRONT TABLE

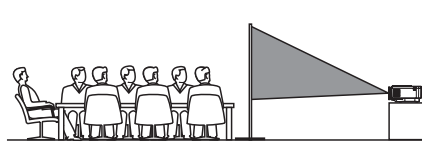

REAR TABLE

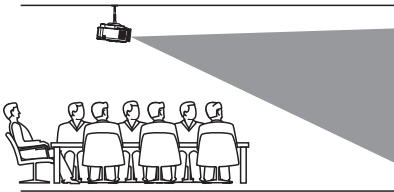

FRONT CEILING

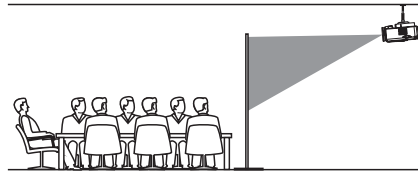

REAR CEILING

Image Adjustment

◀ FOCUS ▶

— — — — —
 ■ / \ — + — / \ ■
 KEYSTONE

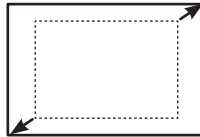
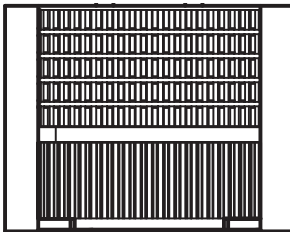

Focus Adjustment

Increase or reduce image size to sharpen image.

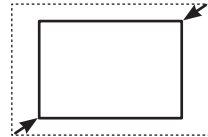

Keystone Adjustment

Adjust image corners to reduce image distortion.

Projector Setup

Ceiling Mount

To mount the projector from the ceiling, you will need mounting hardware as recommended by a professional. Mounting hardware and instructions are not included.

Before mounting, be sure the ceiling structure can support the weight of the projector and the mount itself. It is recommended to have this unit mounted by a professional.

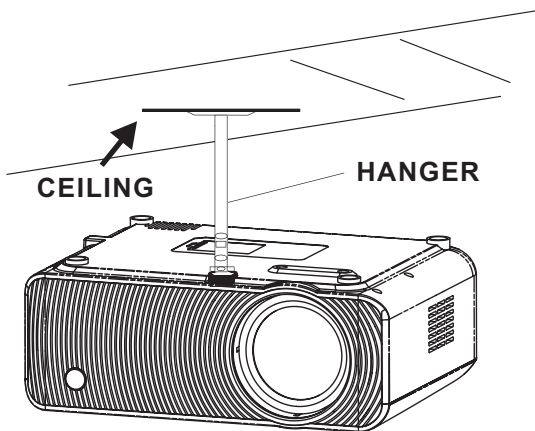
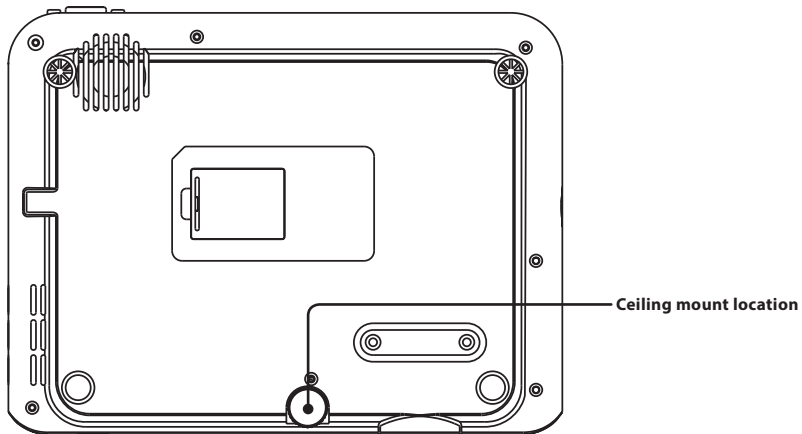

Connecting to Other Devices

Pairing to Bluetooth Wireless Speakers or Sound Bar

NOTE: Bluetooth is OFF by default when the projector first powers ON. Bluetooth can be turned ON or OFF from the OPTIONS Menu.

1. Enable Bluetooth on the receiver (external speakers, sound bar, etc.) to which you wish to connect. *Devices such as smartphones, tablets, or computers are not Bluetooth receivers and will not connect to the projector. To eliminate confusion, you should disable Bluetooth on all receivers to which you do not wish to connect.*
2. Power on the projector and make sure the projector's Bluetooth is ON (see note above). The projector will begin searching for nearby Bluetooth devices to connect to, and will automatically initiate pairing.
3. When successfully paired, the Bluetooth receiver should indicate it is connected, usually with a chime or other audible noise. *Check the user manual on your Bluetooth receiver for more information.*
4. When successfully connected, the projector will display the Bluetooth receiver's name on the top right portion of the Main Menu screen, and sound played from the projector will be heard through the Bluetooth receiver.

After initial pairing, the projector and the Bluetooth speakers will stay paired unless unpaired manually by the user, or erased due to a reset of either device. If this occurs or you find either unit is unable to connect, repeat the above steps.

HDMI

HDMI offers superior sound and picture quality, and is the easiest way to play media from a computer, Blu-Ray player, or other device with an HDMI output.

Requires an HDMI cable (not included) and a device with an HDMI output.

1. Using an HDMI cable, connect the **HDMI 1 or 2 input** on the projector to the **HDMI output** on your media player or computer.
2. Set the projector's **Source** to the **connected HDMI input** and use the controls on the connected device to select and play media.

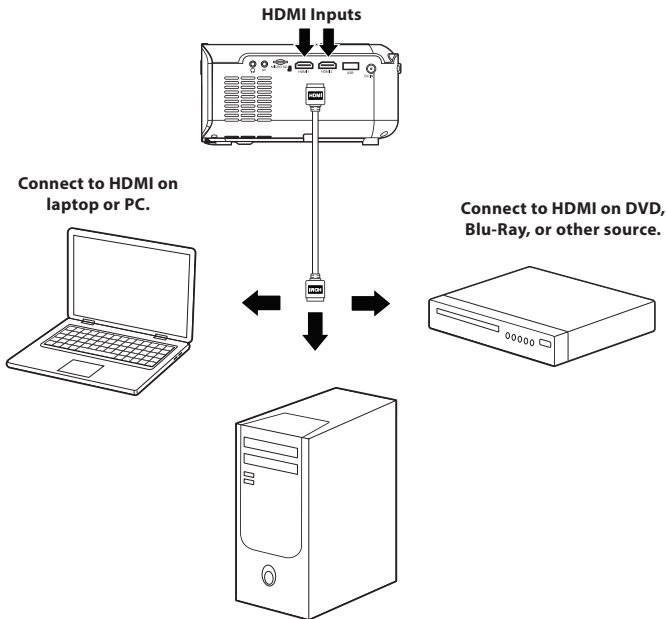

Connecting to Other Devices

Audio/Video Input

Requires a 3.5mm to RCA audio/video cable (included).

1. Connect the 3.5mm to RCA audio/video cable to the AV input on the unit.
2. Connect the 3.5mm to RCA audio/video cable to the RCA stereo audio outputs and composite video output on the media player.
3. Set the projector's **Source** to **AV** and use the controls on the connected player to select and play media.

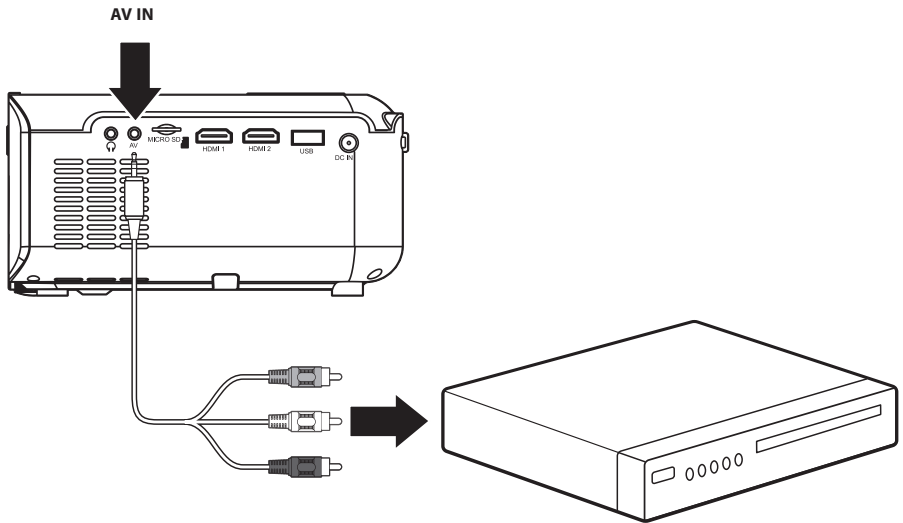

Connect AV cable (included) to media player's AV outputs.

Audio Left Channel - White

Audio Right Channel - Red

Video - Yellow

Computer Video (VGA)

Note: VGA connections do not support audio. You will need to use the computer's speakers to hear audio.

Requires a VGA cable (not included) and a desktop PC or laptop with a VGA output.

1. Using a VGA cable, connect the **VGA input** on the projector to the **VGA output** on your computer.
2. Set the projector's **Source** to **PC** and use the controls on the computer to select and play media.

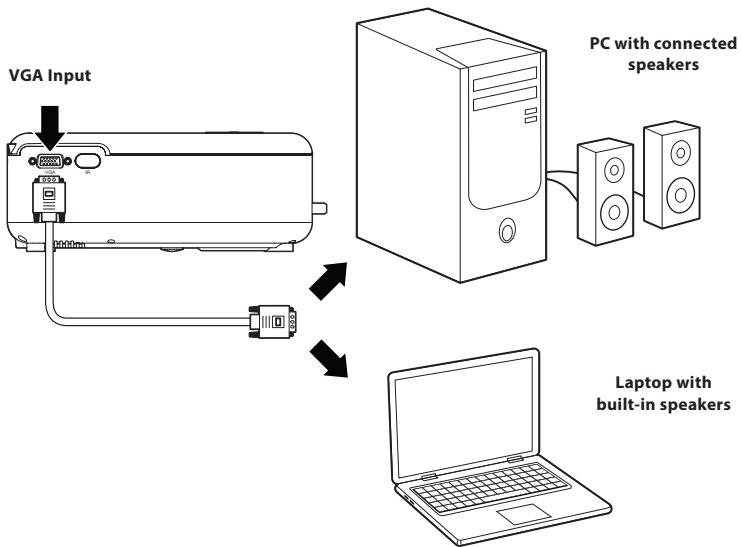

Connecting to Other Devices

External Audio

Requires a 3.5mm to RCA audio/video cable (included).

Note: Speakers must have their own power supply.

1. Using a 3.5mm to RCA stereo cable (included), connect the external powered speakers to the **Headphone Jack** on the projector. *Note: The yellow video plug will not be needed in this setup and will not need to be connected.*
2. The projector will automatically detect the connection and send audio signal to the speakers.

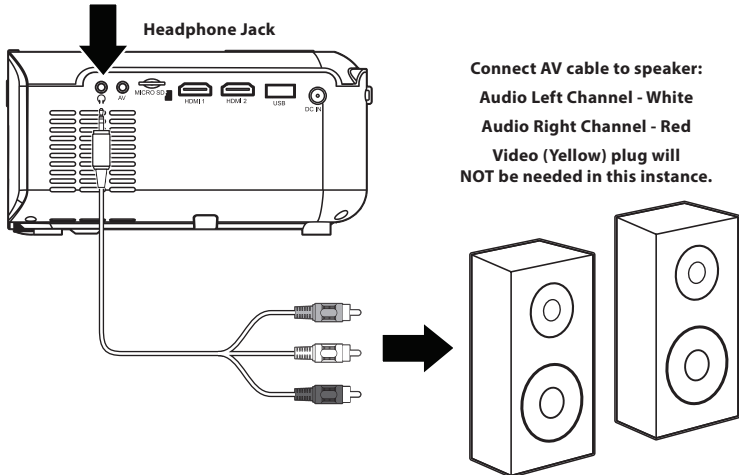

MicroSD & USB Storage Devices

Supports MicroSD cards and USB drives up to 32GB. Supports AVI, MOV file formats.

1. Load a USB drive into the **USB Port**.
2. Set the **Source** to **Media Player**, then use the **Arrow** buttons to select "**C:Drive**" or "**D:Drive**" (C:Drive is the SD card, D:Drive is the USB).
3. Use the **Arrow** buttons to select **Music/Photo/Movie**, then press the **OK** button to begin playing content from the connected storage device.

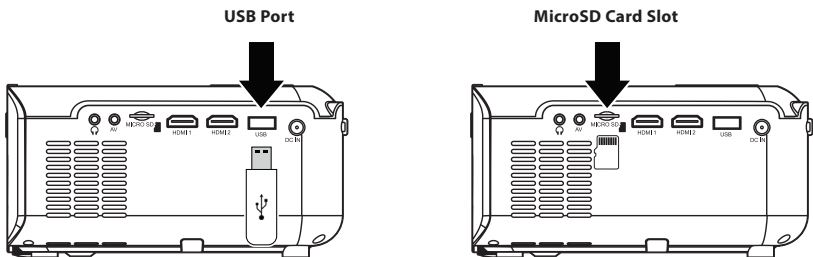

Customer Support

Contact Information

Website: www.gpx.com

Email Support: prodinfo@dpiinc.com

Email Parts: partsinfo@dpiinc.com

Phone Support: 1-888-999-4215

Warranty

For Warranty Information and the most up-to-date version of this User's Guide, go to: www.gpx.com

International Support

To download this User's Guide in English, Spanish, and French, or to get answers to frequently asked questions, visit the support section at: www.gpx.com

Para descargar este Manual del Usuario en inglés, español y francés, o para obtener respuestas a preguntas frecuentes, visite la sección de apoyo en: www.gpx.com

Pour télécharger ce guide de l'utilisateur en anglais, espagnol ou français, ou pour obtenir des réponses à des questions fréquemment posées, consultez la rubrique d'assistance sur: www.gpx.com

Copyright © 2019 Digital Products International (DPI, Inc.) All other trademarks appearing herein are the property of their respective owners. Specifications are subject to change without notice.



***Protect for Today
Sustain for Tomorrow***

