

a sound relationship

Russound

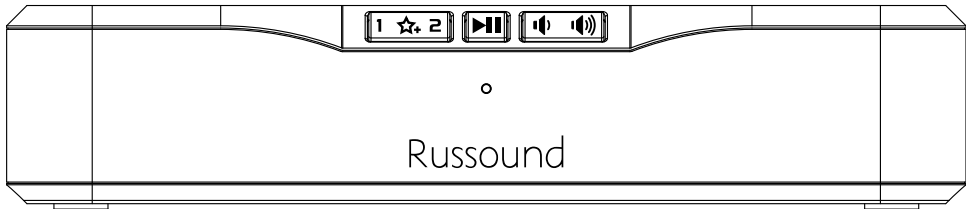

MBX-PRE Streaming Media Player

Installation Manual



NOTICE:

IF YOU ARE NOT A RUSSOUND CERTIFIED INSTALLER, YOU WILL NOT BE ABLE TO INSTALL AND CONFIGURE THIS PRODUCT

INTERNET CONNECTION REQUIRED FOR PRODUCT INSTALLATION

There are two things that must be done at the time of installation of this product that require a working internet connection:

1. Enter valid Russound Certified Installer credentials. The MBX-PRE is shipped in a locked state. It cannot be operated without first being configured by a Russound Certified Installer.

If you are a custom installation professional and wish to become authorized as a Russound Certified Installer, please contact your Russound Sales Representative for more information.

Note: If you are a Russound Certified Installer and you plan on installing this product on a job site that may not have working internet access, please configure the unit at your shop or other location where internet access is available BEFORE you take it to the job site.

2. Firmware may be updated easily through Web Config configuration. An internet connection is required for obtaining the most recent firmware.

Note: If an internet connection will not be available at the place of installation, please download the latest firmware from the Russound website to a laptop **before** going to the job site.

Lockdown Feature

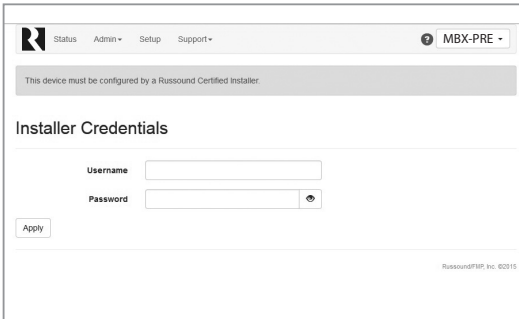

The screenshot shows a web browser interface for the MBX-PRE device. At the top, there is a navigation bar with 'Status', 'Admin', 'Setup', and 'Support' menus, and a 'MBX-PRE' dropdown menu. Below the navigation bar, a message states: 'This device must be configured by a Russound Certified Installer'. The main content area is titled 'Installer Credentials' and contains two input fields: 'Username' and 'Password'. The 'Password' field has a small eye icon to its right. Below the input fields is an 'Apply' button. At the bottom right of the page, there is a small copyright notice: 'Russound®/PMP, Inc. ©2015'.

Russound Certified Installer credentials must be entered through the Web Config configuration web pages.

When the MBX-PRE is shipped from Russound, it will only operate in a "locked" state. In this state, no audio or control is available. In order to unlock the system, valid Russound Certified Installer credentials must be entered using our convenient Web Config browser-based configuration utility.

When the MBX-PRE is first powered on, a message will appear on any compatible user interfaces and the MyRussound App indicating that the device must be unlocked. The message will contain the IP address of the controller. Using your mobile device or computer, browse to the controller's IP address (type <http://> and then the IP address).

If you are using the MyRussound App, the IP address appears as a link that will direct you to Web Config via your local web browser.

If you do not have a valid Russound Certified Installer credential, please contact your Russound Sales Representative.

Table of Contents

Product Overview	3
Web Configuration.....	4
Ethernet Connection and Factory Reset.....	5
Installation Overview.....	6
Installation and First Time Setup	8-11
Configuration.....	12-17
Troubleshooting	18
Audio Connection with MCA-Series Controllers.....	19
Additional Connection Diagrams.....	20
Network Best Practices.....	21
Technical Specifications	22
Safety Instructions	23
Limited Warranty	25

Product Overview

The MBX-PRE Streaming Audio Player is designed to offer a simple-to-install and simple-to-configure streaming media solution to add high quality streaming audio content to any audio system. The MBX-PRE can be used as a single stereo audio streaming source for a single room, or supply a single audio stream to a larger whole-house system through its easy-to-use analog line-level/digital (coax/optical) outputs.

The MBX-PRE allows for expansion to up to 32 streaming rooms of audio in a single installation with any combination of other MBX-Series® streaming products from Russound. When paired with a Russound multi-room controller, system expansion is possible up to 8 independent audio sources and up to 48 total rooms of audio.

In addition to offering streaming audio from popular internet sources, the MBX-PRE also offers streaming of local UPnP™-compliant audio. In addition, a built-in USB port allows users to connect an external flash drive or an externally-powered USB hard drive for use as additional music sources.

Features

- Independent streaming audio player
- Built-in AirPlay streaming with full metadata to iOS/Android apps or XTSPPlus touchscreens
- Built-in Chromecast for Audio support with full metadata to iOS/Android apps or XTSPPlus touchscreens
- Bluetooth Audio
- Hi-Res audio streaming support up to 24-bit/192 kHz
- USB for Flash or external USB Hard drive-based music collections
- Digital (PCM) and Analog Stereo Inputs
- Digital or analog output
- Can be integrated (as a source) with a Russound multi-room system or standalone (as a zone) when used with any brand of amplifier or receiver
- Controllable with the MyRussound App and fully compatible with the Russound XTSPPlus in-wall touchscreen
- Bass, Treble, and Loudness settings available through the MyRussound App
- Supports local favorites
- Onboard browser-based configuration, accessible from a smartphone or tablet
- Mix and match with other MBX-Series® components for versatile system designs

WEB CONFIGURATION

Key Programming Features

The MBX-PRE has a programming feature called Web Config. Web Config is an onboard hosted web page used for unlocking and configuring the MBX-PRE. Web Config can be accessed by entering the IP address or Hostname in any web browser on a smartphone, tablet, or laptop that is connected to the same network as the MBX-PRE. Using Web Config, the MBX-PRE can be completely configured, quickly and easily, from the palm of your hand.

For more information, refer to the installation manual of your specific Russound controller.

Web Config Features

- General Network Configuration (DHCP/static IP)
- Firmware Updates
- Zone or Source Mode
- Assign Device Name
- Zone/Source Volume Trim
- Set AirPlay Password

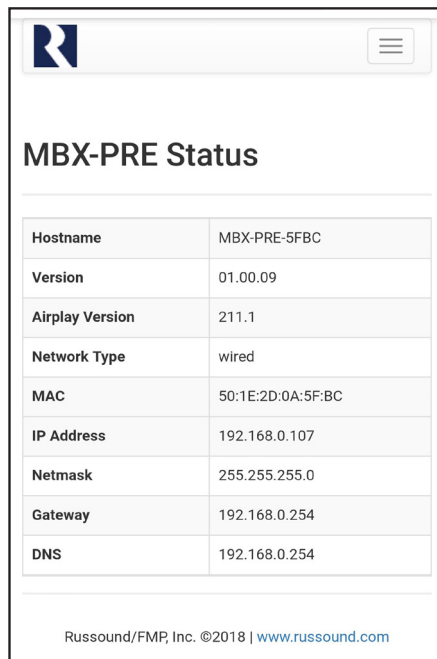

Hostname	MBX-PRE-5FBC
Version	01.00.09
Airplay Version	211.1
Network Type	wired
MAC	50:1E:2D:0A:5F:BC
IP Address	192.168.0.107
Netmask	255.255.255.0
Gateway	192.168.0.254
DNS	192.168.0.254

Russound/FMP, Inc. ©2018 | www.russound.com

Web Config status page.

Ethernet Connection

The Ethernet connection is used for configuration and programming as well as for enabling control via the MyRussound App or the XTSPPlus Touchscreen. The default network setting is DHCP-enabled, but the MBX-PRE can be configured with a static IP address using the Web Config software. The Ethernet connection is also used for the built-in streaming services and for playing any music stored on connected network drives using UPnP.

Factory Reset

The factory reset button has three functions. A 1-second press will initiate a device reboot. A 3-second press and hold will restore network settings to DHCP. A 10-second press and hold will completely reset the MBX-PRE to its factory default settings.

Note: Performing a factory reset will restore the unit to its factory default settings and put MBX-PRE in Zone mode. The unit will require valid Russound Certified Installer credentials in order to be unlocked and configured again. The factory reset will also delete all personal information including service account settings and passwords.

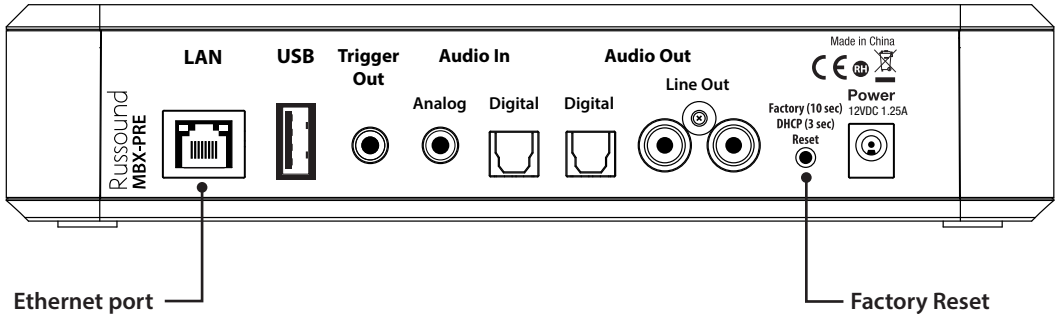

INSTALLATION OVERVIEW

The MBX-PRE can be mounted on a table-top or shelf, but can also be mounted in a rack by using a 2U or larger rack shelf. A 2U or larger rack shelf is required to assure that there is proper ventilation and airflow above the unit.

Important Considerations

1. Disconnect the power cord before making any wiring connections to the MBX-PRE.
2. Verify that all connections and polarity are correct.
3. Keep all power cords away from all signal cables to prevent humming caused by induced noise.
4. Label wires appropriately, on both ends of the wire run.
5. Avoid running signal cables close to house electrical wiring for any distance. If you have to run them parallel, make sure to space the wires at least two feet from the AC line. If you need to cross an AC line it should be at a 90° angle.

Step 1.

Connect the appropriate audio output of the MBX-PRE to your system using either the analog connection (stereo line-level RCA), or one of the digital outputs (coax or optical).
Note: Connection cables are NOT included with the MBX-PRE.

Step 2.

Connect the 12vDC power cable barrel plug into the Power connection on the rear of the MBX-PRE.

1. The external power supply included with the MBX-PRE is shipped with a US power adapter attached. Additional adapters are included for Euro, UK, and Australian plugs. To change the adapter, depress and slide the tab as shown below and remove the existing adapter. The new adapter will snap in place as shown below.

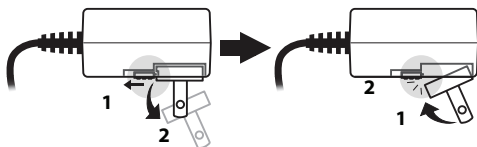

The MBX-PRE will take about 30 seconds to fully power up. When ready, the front panel LED will illuminate either green or yellow. Green means that a network connection has been made and yellow means that the unit is ready but not connected to a wired or wi-fi network. See below for Network Connection information.

Step 3. Network Connections

The MBX-PRE requires a network connection in order to use the MyRussound app or an XTSPplus touchscreen for system control. The network connection is also used for accessing all streaming audio sources other than Bluetooth or any connected USB drives. The MBX-PRE works with Wired Ethernet connections (preferred) or with wireless connections using Wi-Fi.

A. Wired Ethernet Connection (Preferred)

Connect an Ethernet cable from an open network port to the port labeled “LAN” on the rear of the MBX-PRE. The front panel LED of the MBX-PRE will turn green when the network connection is successfully established.

Note: If using Chromecast (Recommended), open your Google Home app on your phone/tablet and follow the prompts to add your MBX-AMP to your list of devices.

B. Wi-Fi Connections

The MBX-PRE can be connected to the network utilizing Wi-Fi. There are four ways to configure the Wi-Fi settings. The easiest method is using a phone/tablet to transfer existing Wi-Fi settings.

Option B1 (Recommended for all systems)

The MBX-PRE can be quickly added to an existing Wi-Fi network by utilizing the Google Home app. The Google Home app is also used to configure the MBX-PRE’s for Chromecast Built-in for Audio. If you do not yet have the Google Home app on your device, download and install it from the Google Play Store or Apple App Store.

Open the Google Home app and it will automatically discover the MBX-PRE* on your network. It will be listed as “MBX-PRE-XXXX”, with XXXX being the last 4 digits of the MAC ID of the MBX-PRE.

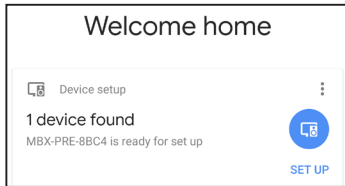

Sample Google Home screen showing a newly discovered MBX-PRE

1. From the Google Home app, find your MBX-PRE either on the main screen or under “Devices” and choose “Set Up”.
2. Choose a name for the MBX-PRE. The name you choose will be name that is visible within the MyRusound app and any other network based interface to identify the MBX-PRE. There is a list of possible room names as well as an option to use a custom name “Add a custom room”.
3. If you are using the MBX-PRE as a source device such as with a controller or multizone receiver, it is important to identify the MBX-PRE as a source rather than name it as a particular room. Suggested names are:

Jane's Streamer	Jane's Music	Streamer
Bill's Streamer	Bill's Music	Streamer 2
Her Streamer	MBX-PRE	Stream 1
His Streamer	MBX-PRE 1	Stream 2

*During the setup process, the MBX-PRE will play a tone in order to confirm that you are configuring the proper device. Because the MBX-PRE is a pre-amplifier, it must be connected to an active amplifier or to the active selected source input of a receiver or controller in order for the tone to be heard.

4. If you are using the MBX-PRE as a dedicated source for a particular room of the home, we suggest naming the MBX-PRE as that particular room, such as “Kitchen”.

5. After selecting the name, the next step is connecting to Wi-Fi. Choose the Wi-Fi network you would like to connect to, or enter the appropriate connection information manually and follow the prompts to continue. The MBX-PRE will attempt to connect to the selected network and the front panel LED will turn green when the connection is successful.

Option B2 (iOS devices only)

1. From an iOS device that is on the Wi-Fi network that you would like to use with the MBX-PRE, go to Settings – Wi-Fi – Set up new Airplay speaker. The MBX-PRE will be listed there as “MBX-PRE-XXXX” with XXXX being the last 4 digits of the MAC ID.

2. Select the MBX-PRE you want to configure.

3. Rename the MBX-PRE depending on how and where it will be used. Please refer to the suggested naming instructions above.

4. Follow the prompts to connect to the appropriate Wi-Fi network.

5. The MBX-PRE will attempt to connect to the selected network and the front panel LED will turn green when the connection is successful.

INSTALLATION AND FIRST TIME SETUP

Option B3 (Using a soft access point)

The MBX-PRE will broadcast an SSID of “MBX-PRE-XXXX.h013” with XXXX being the last 4 digits of the MAC ID of the device.

1. From your phone/tablet connect to the MBX-PRE-XXXX.h013 Wi-Fi network.
2. From a browser on your phone/tablet, navigate to “http://192.168.255.249” to access the Web Config page of your MBX-PRE. You can access the network settings by navigating to Admin-Networking. It is recommended to use “Automatic” as the Networking Type. Select the Wi-Fi network you would like to connect to and enter the appropriate password.
3. Select “Apply” to apply the new settings and the MBX-PRE will reboot and attempt to connect to the Wi-Fi network. The front panel LED of the MBX-PRE will turn green when a successful connection has been made.

Option B4 (Configuring using a wired connection)

Connect the MBX-PRE to the network using a wired connection and then use Web Config to access the MBX-PRE settings and enter the appropriate network SSID and password settings. These settings are accessed in the Admin-Networking section.

Network Connection Type

The first selection to make is the type of network connection you would like to use. There are three possible options:

Automatic (Default) – Automatic is the preferred setting for almost all systems. When set to “automatic”, either a wired or wireless connection can be used and the MBX-PRE will prioritize the wired connection whenever it is present. If a wired connection is not available, the MBX-PRE will use the currently configured Wi-Fi settings to attempt to connect to the network.

Wired – When set to “Wired”, the Wi-Fi connection will be disabled. The only connection method available will be the Wired Ethernet connection. This option is recommended for all rack-based installations or whenever Wi-Fi network pollution might be an issue and you want to reduce the number of available Wi-Fi devices in the local environment.

Wi-Fi – When set to “Wi-Fi”, the Wired Ethernet connection will be disabled. This setting should only be used in environments when you want to disable physical access to the network connection such as a commercial installation. This setting is NOT recommended for typical usage.

First Time Setup

The first time that a user navigates to the MBX-PRE Web Config page, Web Config will open automatically in First Time Setup mode.

First Time Setup is designed to help configure a few basic system settings as well as to provide for a quick method of enabling Chromecast Built-in for Audio.

Using a web browser from any device (phone, tablet, or computer) that is on the same network as the MBX-PRE, navigate to the MBX-PRE’s Web Config page by entering one of the following:

1. MBX-PRE IP address – Example: if the IP address is 192.168.0.105, enter http://192.168.0.105 into the web browser. If you don’t know the IP address, you can use a network scanning app such as Fing (Free for iOS and Android) to discover the IP address.

2. MBX-PRE Hostname – The hostname is printed on a label on the bottom of the MBX-PRE. The hostname is formatted as MBX-PRE-XXXX where XXXX is the last four digits of the MBX-PRE’s MAC ID. Example: If the hostname is MBX-PRE-1234, enter http://MBX-PRE-1234 into the web browser.

Device Name

The first item you will see on the first time setup screen is

the device name. The default device name is the hostname MBX-PRE-XXXX. If you edited the name using Google Home, or in your Apple configuration in the Installation steps above, the name will be whatever you entered. The name can be edited here or changed at any time in the future using Web Config.

Option 1 – (Source Mode) MBX-PRE connected to a multiroom audio system or controller - If the MBX-PRE is being used as a source device that is available in multiple rooms of a home, we recommend naming it as a streamer such as “Streamer 1”, “Streamer 2”, etc, or ideally, if there is an MBX-PRE for every occupant of the home, we recommend naming it “Bob’s Streamer”, “Mary’s Streamer”, etc.

Option 2 – (Zone Mode) MBX-PRE dedicated for use in a particular room/rooms – If the MBX-PRE is being used to send audio to a dedicated room or area in a home, we recommend naming it for the room/area, such as “Kitchen”, “Master Bedroom”, “Patio”, etc.

The name you choose will be the name that is visible within the MyRussound app when controlling the MBX-PRE and also the name that will appear in apps when attempting to cast or stream audio from a phone or tablet.

The name can be changed at any time.

Networking

Because the MBX-PRE is already on the network (or you wouldn’t be able to get to the First Time Setup screen), the primary reason for making a change on this page is if you have connected via a wired connection and want to input a Wi-Fi configuration SSID and password to use the MBX-PRE with Wi-Fi. It is also possible to modify DHCP settings here and set a static IP for either the wired connection, the wireless connection, or both. These settings can be changed again at any time in Web Config.

Type – The default type of networking is automatic. This is recommended for almost all installations. When set to “automatic”, the MBX-PRE will always prioritize a Wired

Ethernet connection if available. If a wired connection is not available, it will attempt to connect to the last properly configured Wi-Fi network. Because it works with both types of connections and prioritizes wired whenever it is available, the “automatic” setting is always recommended.

When set to “Wired”, the MBX-PRE’s Wi-Fi radio will be disabled. The only way to connect the MBX-PRE to a network will be by use of the Wired Ethernet connection.

When set to “Wireless”, the MBX-PRE will disable the Ethernet port and will only be able to connect to a network using Wi-Fi.

The screenshot displays the 'First Time Setup: Networking' interface. At the top left is a logo, and at the top right is a menu icon. The main heading is 'First Time Setup: Networking'. Below this, there are three radio buttons under the heading 'Type': 'Automatic' (which is selected and highlighted in blue), 'Wired', and 'Wireless'. Underneath the 'Type' section is a 'Wired' section containing a 'DHCP' toggle with 'Enabled' selected. At the bottom of the screen is a 'Wireless' section with a 'Wi-Fi Select' dropdown menu that currently shows 'Select Wi-Fi'.

FIRST TIME SETUP

Adding Wi-Fi configuration info

Under “Wireless”, choose “Select Wi-Fi”. A list of available Wi-Fi networks will appear. If you would like to manually enter an SSID and password, simply select “Enter Manual SSID” from the choices and enter the network configuration information following the user prompts.

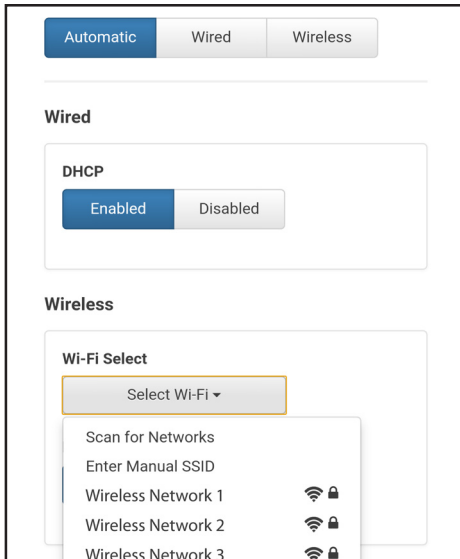

The screenshot shows a network configuration interface. At the top, there are three tabs: "Automatic" (selected), "Wired", and "Wireless". Below the tabs, the "Wired" section is visible, showing a "DHCP" toggle set to "Enabled". The "Wireless" section is also visible, showing a "Wi-Fi Select" dropdown menu. The dropdown menu is open, displaying the following options: "Scan for Networks", "Enter Manual SSID", "Wireless Network 1" (with a Wi-Fi icon and a lock icon), "Wireless Network 2" (with a Wi-Fi icon and a lock icon), and "Wireless Network 3" (with a Wi-Fi icon and a lock icon). The "Select Wi-Fi" dropdown is highlighted with a yellow border.

Note: If you enter new Wi-Fi information here and apply the changes, your MBX-PRE will attempt to connect to that Wi-Fi network and its network IP address will change. If necessary, enter the new IP address or hostname in your browser again in order to return to the First Time Setup screen.

Date and Time

From the drop-down menu's select the country where the MBX-PRE is located as well as the region. This information will allow the MBX-PRE to automatically keep its date and time information accurate at all times.

Firmware Update

The MBX-PRE will automatically verify if it is running the most up-to-date firmware. If it is, you'll see the message "Software is up to date". Otherwise, select the update to get the latest firmware. It is ALWAYS recommended to run the most recent available firmware on your MBX-PRE and other Russound devices.

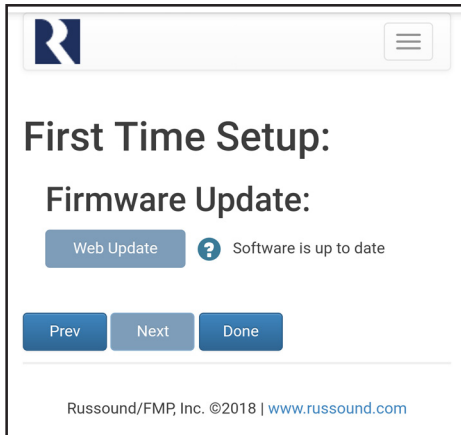

Updating the unit will not erase any of the settings or configuration steps that you have already done.

Select "Done" to exit the First Time Setup menu and the MBX-PRE will take you to Status Page for further configuration steps. The first step in the Status Page is unlocking the product for use.

Lockdown Feature

When the MBX-PRE is shipped from Russound, it will only operate in a "locked" state. In this state, no audio or control is available. In order to unlock the system, valid Russound Certified Installer credentials must be entered using our convenient Web Config browser-based configuration utility.

If you do not have a valid Russound Certified Installer credential, please contact your Russound Sales Representative.

Note: If you are a Russound Certified Installer and you plan on installing this product on a job site that may not have working internet access, please configure the unit at your shop or other location where internet access is available BEFORE you take it to the job site.

CONFIGURATION

The MBX-PRE has two different modes of operation: Source mode and Zone mode.

Source mode is used for connecting an MBX-PRE as an audio source to a Russound C-Series or MCA-Series controller.

Zone mode is used for connecting an MBX-PRE as a streaming audio player with an amplifier or receiver.

Option 1.

Configuring the MBX-PRE as an audio source with a Russound MCA-Series controller

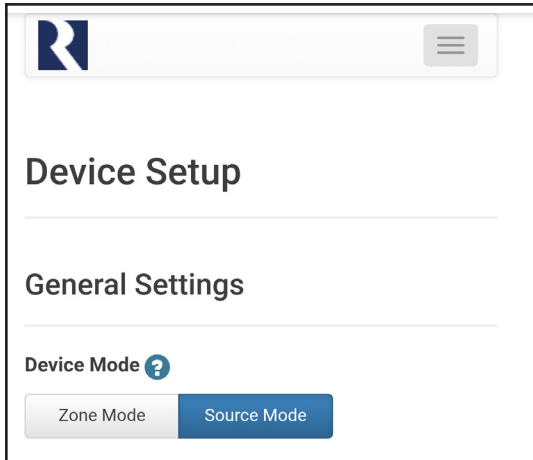

Step 1.

Operating Mode Selection - In the MBX-PRE Web Config, navigate to Setup in the menu options. Under Device Settings, choose "Source Mode" as shown above. Once "Source Mode" has been selected, identify the source number that corresponds to the input source number of the Russound controller. For example, if the MBX-PRE is connected to Source 4 on the controller, choose "4" and select OK.

Step 2.

Naming the MBX-PRE – Enter the desired name for this MBX-PRE. This name will be visible to end users in the list of available Apple AirPlay devices, Chromecast Built-in for audio and Spotify Connect devices for users to select when streaming from a phone, tablet, or computer. For example, an appropriate name when using the MBX-PRE with an MCA-66 controller as Source 4 might be "Streamer". An appropriate name when using the MBX-PRE in Zone Mode might be "Kitchen" or "Living Room"

Step 3.

AirPlay Password (Optional) - If you want to use an AirPlay password to limit access for AirPlay users to stream audio to this MBX-PRE, enter an AirPlay password and select "Apply". This same password must be entered on any iOS device when using Apple AirPlay to stream audio to the MBX-PRE. If you do not want to use a password to control access to AirPlay, leave the AirPlay Password field blank.

Step 4.

Configuring the Russound Controller –

Note: This step shows the basic configuration when using an MCA-Series controller such as the MCA-66 or MCA-88 (Firmware Version 4.0 or higher is needed).

1. Navigate to the Web Config page of the Russound Controller. It may be available by selecting on the drop-down menu in the top right hand section of the MBX-PRE's Web Config page.

If the controller is not visible in the drop-down list, navigate to the controller's Web Config page by entering the controller's IP address or hostname in your web browser (a controller's hostname is normally located on a label concealed under the controller's removable front panel).

2. From the controller's Web Config page, navigate to the Setup > Source Settings page.

- Enter a name for the MBX-PRE in the appropriate Source Name field that corresponds to the name that you entered for the MBX-PRE when you configured its name.

The name you enter for the controller source name is the name that will be visible to users when selecting a source from the MyRussound app or the XTSPPlus touchscreen.

3. After naming the source, select 'Edit' next to the source.
 - Under Source Information, select the Device Type drop down. Then select Russound Media Streamer
 - Depending on the controller model and the source you have selected, you may have additional options such as the Audio Input type (Analog, Digital Coax, or Optical).
 - Adjust the Volume Trim if desired. The Volume Trim is used to allow compensation from one audio source to another so that volume levels do not jump within a room when different audio sources are selected on a controller. For example, certain audio devices such as a CD/DVD player may have a higher audio level than another device. You can use the volume trim levels to adjust the levels of every source on your Russound controller
 - Select Done when finished.

Congratulations! Your MBX-PRE is now fully configured to work with your Russound Controller.

CONFIGURATION

Option 2.

Using the MBX-PRE as a streaming audio player with an amplifier or receiver (Zone Mode)

Device Setup

General Settings

Device Mode ?

Zone Mode Source Mode

Configuration Password

Disable Enable

Device Name ?

AirPlay Password ?

Step 1.

Operating Mode Selection - In the MBX-PRE Web Config, navigate to Setup in the menu options. Under Device Settings, choose Zone Mode. Once Zone Mode has been selected, additional configuration options will be displayed.

Step 2.

Naming the MBX-PRE – The name you choose will be visible to all users in the MyRussound App or other user interface when selecting the zone or room that they wish to control. Suggested names when the MBX-PRE is configured as a zone include such names as:

Master Bedroom	Dining Room	Guest Room
Billy's Room	Patio	Office
Great Room	Pool	Bath
Kitchen	Veranda	Media Room

This name will be visible to end users in the list of available Apple AirPlay devices, Chromecast built-in for audio and Spotify Connect devices for users to select when streaming from a phone, tablet, or computer.

Step 3.

AirPlay Password (Optional) - If you want to use an AirPlay password to limit access for AirPlay users to stream audio to this MBX-PRE, enter an AirPlay password and select "Apply". This same password must be entered on any iOS device when using Apple AirPlay to stream audio to this MBX-PRE. If you do not want to use a password to control access to AirPlay, leave the AirPlay Password field blank.

Step 4.

Adjusting the Volume Trim (Optional) - The Volume Trim is used to allow compensation from one audio source to another so that volume levels do not jump within a room when different audio sources are selected on a receiver or amplifier that allows switching of more than one audio source. If you are using the MBX-PRE with a single-input stereo amplifier, the Volume Trim does not need to be adjusted.

Step 5.

Line Output Settings – If using the analog line-level outputs of the MBX-PRE, you may select from either Variable (Default) or Fixed. The appropriate setting will depend

on how the MBX-PRE is being used within your particular audio system. Note that this setting will only affect the analog output. Both digital outputs (coax and optical) are unaffected by changes to this setting and always operate in Fixed mode.

Congratulations! Your MBX-PRE is now fully configured to work with your amplifier or receiver.

Firmware Updates

By default, the MBX-PRE will search periodically for any available firmware updates. When an update is available, the update process will happen automatically with no need for any user interactions. In order to minimize any disruption to the enjoyment of the Russound audio system, the update time can be set in the Admin-Firmware Update section of Web Config. You can set the Update Time to any time when the system is unlikely to be in use. For example, 3:18 AM is a time when most audio systems are unlikely to be in use. Set the time as appropriate for your particular installation.

Dynamic and Static IP Addresses

The MBX-PRE can be configured with either a dynamic DHCP address (Default) or a static IP address. This setting is available for both the Wired Ethernet connection and the Wi-Fi Ethernet connection. While the setting for a static IP address is available, Russound recommends using a dynamic DHCP address and setting up DHCP reservations on the network router to get all of the benefits of a static IP address but with the added benefit of being able to control or modify any IP addresses from a single location.

Note: Any time that the IP address is changed or modified in WebConfig, you will need to re-navigate in your browser to the NEW IP address of the MBX-PRE.

Power

As an advanced networking device, the MBX-PRE is designed to be left on at all times. This allows instant access to your favorite streaming audio sources at any time and is especially useful due to the fact that most installations involve locating the MBX-PRE in remote locations of the home where it would be difficult to know if it is powered on or off or to know its current status.

The MBX-PRE has several options for entering a low-power mode after a specified period of time without being in use. These options are configurable in the "Setup" section of WebConfig.

After the number of minutes configured in "Idle Timeout" in the Admin section of Web Config has passed without any active audio source in use, the MBX-PRE will enter network standby mode automatically. In this mode, the power consumption of the device will be 1.9W.

CONFIGURATION

Configuring Streaming Service Accounts (Optional)

Spotify® – Spotify account credentials are entered in the Spotify app on your phone, tablet, or PC. No additional information needs to be entered on the MBX-PRE. Note that the MBX-PRE Device Name that you set in Web Config will be the same name that appears in the Spotify Connect menu as an available selection, for example “Kitchen”, “Bedroom”, “Patio”, etc. This same name is also the name used when connecting to the MBX-PRE via Apple AirPlay.

SiriusXM® – SiriusXM account credentials are entered by using the MyRussound App or a connected Russound XTSPPlus in-wall touchscreen. Select the MBX-PRE as the active audio source and then choose “SiriusXM” from its menu. If no account information has been entered, a login screen will be displayed.

vTuner® – No account information is needed to access vTuner internet radio. If you wish to associate an MBX-PRE with a vTuner account so that you can share vTuner favorites across multiple devices, you can select “Get Access Code” from the MBX-PRE vTuner menu and enter that code at <http://russound.vtuner.com> to associate an MBX-PRE with your vTuner account.

Tuneln® – No account information is needed to access Tuneln internet radio. If you wish to associate an MBX-PRE with a Tuneln account so that you can share Tuneln favorites across multiple devices, you can select “Account Association” from the MBX-PRE Tuneln menu and enter that code in your account settings page at <http://www.tuneln.com> to associate an MBX-PRE with your Tuneln account.

Deezer® – A Deezer subscription is required to use Deezer on your device. First, head to deezer.com/offers and sign up to start your free trial*. Next, Deezer account credentials are entered by using the MyRussound app or a connected Russound XTSPPlus in-wall touchscreen. Select the MBX-PRE as the active audio source and then choose “Deezer” from its menu. If no account information has been entered previously, a login screen will be displayed.
*terms and conditions apply

Listening to AirPlay Streaming

The MBX-PRE supports Apple’s AirPlay technology. AirPlay enables you to listen to your iTunes library or other audio content from any AirPlay-enabled Apple device through the MBX-PRE. With AirPlay, your iOS device becomes an extension of your audio system.

MBX-PRE – Zone Mode

When the MBX-PRE is used in Zone Mode, using AirPlay will instantly turn on the MBX-PRE and start playing music from your phone, tablet, or computer.

When AirPlay is selected from iTunes or an iOS mobile device, the MBX-PRE will activate and select the internal streamer as the source.

When the MBX-PRE is actively streaming AirPlay, the volume control on the MBX-PRE and the AirPlay-enabled device are linked, which means a change in volume on the AirPlay-enabled device will also change the volume level of the MBX-PRE and vice versa.

MBX-PRE – Source Mode

When the MBX-PRE is used in Source Mode with a Russound controller, AirPlay must be configured to a primary zone on the controller in order to allow easy access for AirPlay to instantly turn on the zone and start playing music from your phone, tablet, or computer. By default on Russound controllers, Zone 1 is the primary AirPlay zone.

When AirPlay is selected from iTunes or an iOS mobile device, the Russound controller will turn the primary AirPlay zone on and select the internal streamer of the MBX-PRE as the active audio source.

When the MBX-PRE is actively streaming AirPlay, the volume control for the primary AirPlay zone and that of the AirPlay-enabled device are linked, which means that a change in volume on the AirPlay-enabled device will also change the zone volume level on the Russound controller and vice versa.

AirPlay Password

The MBX-PRE supports an optional AirPlay password feature that when set, requires a password in order for an iOS device to stream to the MBX-PRE using AirPlay. You'll find the AirPlay password settings using Web Config in the "Setup" tab.

Under AirPlay Password, enter the desired password. When a password has been configured, any time that the MBX-PRE is selected from the list of available AirPlay devices, a message will appear on the iOS device, prompting for the AirPlay password. Once the correct password is entered, the iOS device can successfully stream music to the MBX-PRE. The iOS device will retain the password for future use.

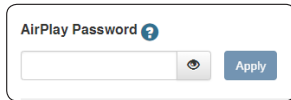

Multiple Streaming Products

Note that account settings are individual settings for each MBX-PRE or other Russound MBX-Series® streaming product. If you have multiple MBX-Series® devices, each must be configured with the appropriate account login information. This is done so that each device can have its own independent user in a home so that users will not have to share accounts or favorites with anyone else in the home. The ideal installation is for each user in a home to have their own personal MBX-Series® streaming device so that each user always has access to their favorite music selections.

Using Bluetooth

In order to pair a Bluetooth device with the MBX-PRE, you must enter Bluetooth Pairing Mode. To enter pairing mode, press and hold the outermost buttons on the MBX-PRE front panel (Favorite 1 and Volume Up) for a few seconds until the front panel LED on the MBX-PRE blinks blue twice. The MBX-PRE is now in pairing mode. Use your phone/tablets Bluetooth pairing process to discover the MBX-PRE and complete the pairing.

Using Quick Access Buttons

The MBX-PRE has two front-panel buttons for quick access to up to 2 favorite audio sources. The buttons operate like radio preset buttons. Press and hold one of the buttons to store the currently playing selection. A quick tap of that button will let you quickly access and start playing that selection again at any time.



Quick Access Buttons

DHCP Reset

A DHCP Reset can be performed using the factory reset button on the rear panel of the MBX-PRE.

If your MBX-PRE cannot communicate on the network, you can reset its DHCP connection by pressing and holding the Reset button on the rear of the MBX-PRE for 3 seconds and then releasing it. This will restore the MBX-PRE to a DHCP connection from a static IP connection. This will also reset the network connection type to "Automatic" so that a wired Ethernet connection can easily be made. Performing the DHCP reset will also delete Wi-Fi configuration information so that the device can be configured for a new wireless connection. Refer to "Wi-Fi Connections" on page 6 for more information on connecting to a Wi-Fi network.

Factory Reset

For a full factory reset, erasing all configuration settings, and re-locking the MBX-PRE:

Press and hold the Reset button on the rear of the MBX-PRE for 10 seconds. The Red Status LED will light and the MBX-PRE will reboot on its own.

Note: Performing a factory reset will restore the unit to its factory default settings and put MBX-PRE in Zone mode. The unit will require valid Russound Certified Installer credentials in order to be unlocked and configured again. The factory reset will also delete all personal information including service account settings and passwords.

TROUBLESHOOTING

General Troubleshooting

This chart explains the operation of the LED:

System Status	Yellow	Green	Red	Blue	Purple	Cyan
Booting	ON	-	-	-	-	-
Ready	-	-	-	-	-	-
Streaming Source is Active	-	ON	-	-	-	-
Bluetooth Streaming	-	-	-	ON	-	-
Bluetooth Pairing	-	-	-	Blinking	-	-
Bluetooth Paused	-	-	-	Blinking	-	-
Digital Input Active	-	-	-	-	-	ON
Group/Party Mode	-	-	-	-	ON	-
Standby Mode	-	-	ON	-	-	-
Firmware Update	-	Blinking	-	-	-	-
Network Error	Blinking	-	-	-	-	-

Check for firmware updates available to make sure that your Russound product is always up to date and to take advantage of any additional features or supporting services that may be available.

Many issues can be resolved by power cycling the MBX-PRE by disconnecting the power supply, waiting 15 seconds and re-connecting the power supply.

For networking issues, resetting network gear in the home such as the router or any switches between the MBX-PRE and the router may also resolve any issues.

If you have the MBX-PRE configured with a static IP address and do not remember the settings, you can reset the MBX-PRE to DHCP by pressing and holding the rear panel Reset button for 3 seconds. If there are any issues reconnecting to the MBX-PRE after resetting to DHCP, unplug the MBX-PRE from the network and re-connect it, or try power cycling the network router to force a new DHCP connection.

For audio connection issues, verify all audio connections from the MBX-PRE to the controller/amplifier/receiver. If connected to a Russound controller, verify that the source number configured on the MBX-PRE matches the source number that has been configured for it on the controller and that the input source type matches the correct type being used (analog, coax, or digital).

Configuration Password

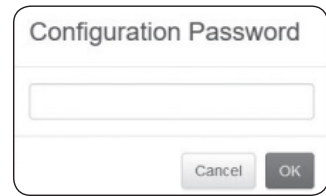

Within Web Config, there is an option in the Setup-Systems Settings menu to Enable/Disable the Configuration Password. This password is disabled by default but can be enabled to prevent inadvertent changes to the MBX-PRE configuration. This is a simple password system to make certain that you want to make changes to key configuration settings before making changes. The password is static and cannot be changed. The configuration password, when enabled, is: **russound123**

When enabled, this password must be entered in order to change any configuration settings.

AUDIO CONNECTIONS WITH MCA-SERIES CONTROLLER

The MBX-PRE can be used with a Russound MCA-Series controller and supported user interfaces to access all features and provide amplification for speakers in multiple locations.

Use the diagram below as an example of possible wiring connections when using a Russound controller with your MBX-PRE.

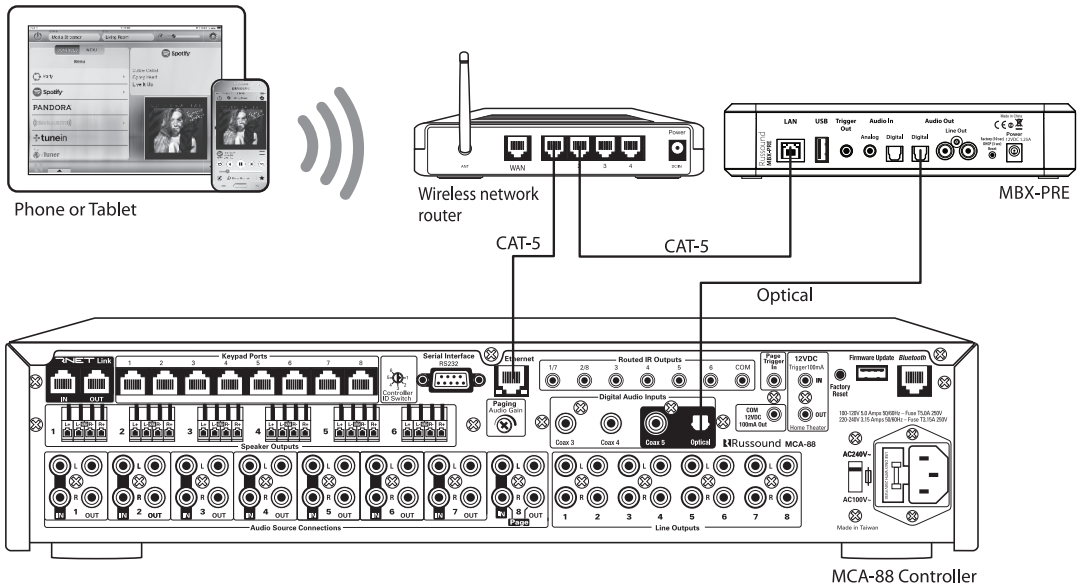

ADDITIONAL CONNECTION DIAGRAMS

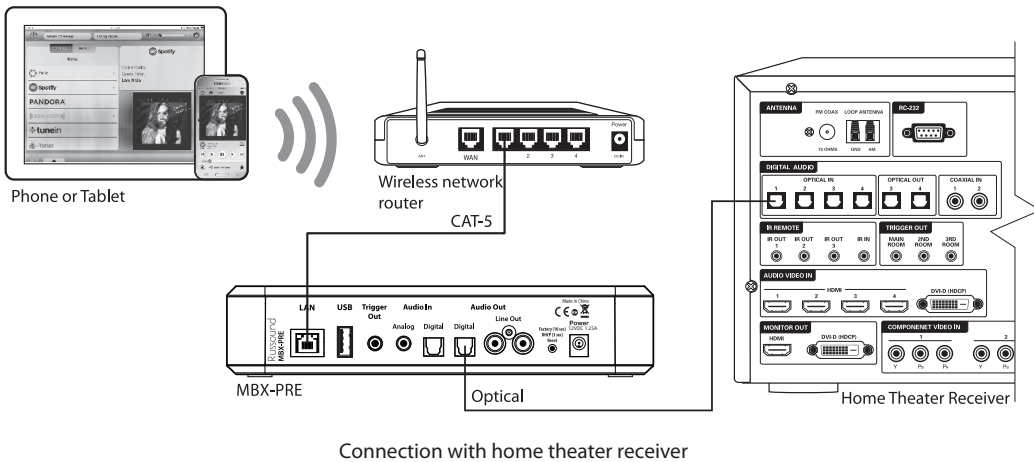
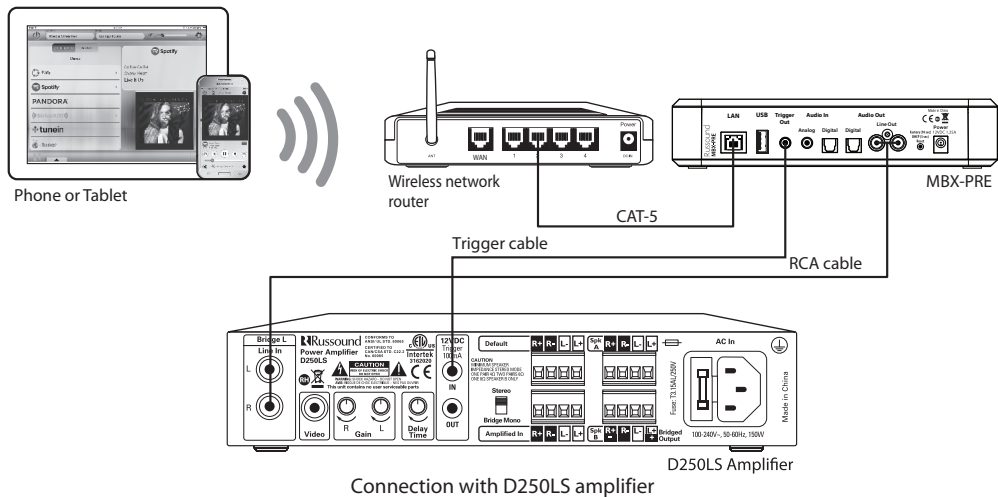

Networking Best Practices

Some of the most common problems can be caused by network configuration and out-of-date firmware. Improper network configuration can prevent MBX-Series® devices from connecting and communicating on the network.

The first step for troubleshooting is to check networking connections and power cycle the equipment to check for proper communication.

A dedicated wireless 802.11n or 802.11ac compatible router is recommended. The reason for this is that ISP supplied modem/router combination devices may have incompatible settings that can cause issues with MBX-Series devices connecting or communicating across the network. It is recommended not to use these modem/router combination devices, because the end user may not have access to all services of the device. The ISP may have sole control over the device settings and send updates to reset, reinitialize, or replace the device at their discretion.

Check for **firmware updates** available for your Russound equipment to make sure they are up-to-date in order to take advantage of any additional features and supported services.

Use a network discovery and IP scanning application that can assist to better understand the network, such as FING. <http://overlooksoft.com/FING> is free and available for iOS and Android and can assist in identifying devices on the network and if there are any IP addressing conflicts.

Bandwidth:

Audio streaming uses substantially less network bandwidth than video streaming or large file transfers. Typical audio streams range from 64 kbps to 160 kbps for most streaming services and hi-res audio streams typically max out at 320 kbps. This compares to video streaming which will typically range from 1.5 to 3 Mbps for SD, 5 Mbps or more for HD and even 25 Mbps or higher for Ultra HD.

Video consumes much more bandwidth overall than audio.

Satellite Internet Service

Due to the inherent high-latency nature of Satellite Internet Service, it is generally incompatible with reliable and enjoyable audio streaming. Russound therefore does not recommend utilizing any of its streaming audio solutions in systems that rely solely on a satellite internet connection. For installations where satellite internet service is the only available option, Russound recommends using UPnP-based NAS drives, flash drives, or AirPlay/casting-type solutions from a dedicated audio source rather than internet streaming.

Router Configuration:

A few routers may need additional configuration to prevent incompatibility or intermittent connection issues. Access the router and check user accessible settings that enable support for **Multicast** or **IGMP** and enable them or check for options that may be actively filtering these protocols and disable those filters. Check for other options that could have an effect on communication: Options such as **UPnP** should be **enabled**. Options such as **IGMP Proxy**, **IGMP Snooping**, **Multicast Filtering** or **WMM Proxy** should be **disabled**.

Glossary

Multicast: The delivery of a message or information to a group of destination computers simultaneously in a single transmission from the source.

Unicast: The delivery of a message or information which is sent from one point to another point. An example would be connecting to an IP address of a URL such as www.google.com.

IGMP: Internet Group Management Protocol is an integral part of IP Multicast and is used for one-to-many networking applications such as online streaming audio and video, gaming, and allows more efficient use of resources when supporting these types of applications.

WMM: Wireless Media Management is designed to support consumer and corporate applications and works with 802.11a, 802.11b and 802.11g. The specification provides basic prioritization of data packets based on four categories - voice, video, best effort and background.

UPnP: Universal Plug and Play uses Multicast and allows media servers and streaming devices to communicate.

TECHNICAL SPECIFICATIONS

Frequency Response	20Hz to 20KHz
Audio Outputs	Analog – Stereo Audio RCA Digital Optical
Line Audio Output	2V rms
Audio Inputs	3.5mm Analog Stereo Audio Digital Optical USB2.0 Media Playback
Communication Ports	Ethernet RJ45 10/100 BaseT
Wi-Fi	802.11ac, dual band
Bluetooth Audio Support	Yes
Trigger Output	12vDC @100mA
Music File Formats	MP3 (CBR, VBR), WAV (8, 16-bit), OGG Vorbis, FLAC (8, 16-bit). AAC, AAC+ (supports up to 24-bit/192 kHz)
Power Requirements	12VDC, 1.25A
Product Dimensions	8.25"W x 7"D x 1.75"H 21cm W x 17.8cm D x 4.5cm H
Product Weight:	1 lb 0.45 kg



Safety Instructions

- 1. Read Instructions** - All the safety and operating instructions should be read before the appliance is operated.
Lisez les instructions - Toutes les instructions de sécurité et doivent être lues avant d'utiliser l'appareil.
- 2. Retain Instructions** - The safety and operating instructions should be retained for future reference.
Conservez les instructions - Les instructions de sécurité et devrait être conservé pour référence future.
- 3. Heed Warnings** - All warnings on the appliance in the operating instructions should be adhered to.
Tenez compte des avertissements - Tous les avertissements figurant sur l'appareil dans les instructions de fonctionnement doivent être respectées.
- 4. Follow Instructions** - All operating and user instructions should be followed.
Suivez les instructions - Toutes les instructions de fonctionnement et d'utilisation doivent être suivies.
- 5. Water and Moisture** - The appliance should not be used near water; for example, near a bathtub, washbowl, kitchen sink, laundry tub, in a wet basement, or near a swimming pool. The apparatus shall not be exposed to dripping or splashing liquids and no objects filled with liquids, such as vases, shall be placed on the apparatus. Do not touch the appliance with wet hands. Do not handle the appliance or power cord with wet or damp hands. If water or any other liquid enters the appliance cabinet, take it to qualified service personnel for inspection.
Eau et humidité - L'appareil ne doit pas être utilisé près de l'eau, par exemple près d'une baignoire, d'un lavabo, d'un évier, machine à laver, dans un sous-sol humide ou près d'une piscine. L'appareil ne doit pas être exposé à des éclaboussures de liquides et aucun objet rempli de liquide, comme des vases, ne doit être posé sur l'appareil. Ne pas toucher l'appareil avec les mains mouillées. Ne manipulez pas l'appareil ou le cordon d'alimentation avec les mains mouillées ou humides. Si de l'eau ou tout autre liquide pénètre dans le coffret de l'appareil, il amène à un personnel qualifié pour l'inspection.
- 6. Cleaning** - The appliance should be cleaned only as recommended by the manufacturer. From time to time you should wipe off the front and side panels and the cabinet with a soft cloth. Do not use rough material, thinners, alcohol or other chemical solvents or cloths since this may damage the finish or remove the panel lettering.
Nettoyage - L'appareil doit être nettoyé uniquement tel que recommandé par le fabricant. De temps en temps vous devriez essuyer les panneaux latéraux avant et arrière et le boîtier avec un chiffon doux. Ne pas utiliser de matériel rugueux, de diluant, d'alcool ou d'autres solvants chimiques ou de chiffons car cela pourrait endommager la finition ou faire disparaître la sérigraphie du boîtier.
- 7. Heat** - The appliance should be situated away from heat sources such as radiators, heat registers, stoves, or other appliances (including amplifiers) that produce heat.
Chaleur - L'appareil doit être placé loin des sources de chaleur telles que des radiateurs, registres de chaleur, poêles ou autres appareils (incluant les amplificateurs) qui produisent de la chaleur.
- 8. Grounding or Polarization** - Precaution should be taken so that the grounding or polarization means of an appliance is not defeated.
La terre ou polarisation - précautions doivent être prises pour que les moyens d'un appareil à la terre ou polarisation ne soit pas annulée.
- 9. Power Cord Protection** - Power supply cords should be routed so that they are not likely to be walked on or pinched by items placed upon or against them, paying particular attention to cords at plugs, receptacles, and the point where they exit from the appliance.
Protection du cordon d'alimentation - Les cordons d'alimentation doivent être acheminés de sorte qu'ils ne sont pas susceptibles d'être piétinés ou coincés par des objets placés sur ou contre eux, en accordant une attention particulière aux cordons au niveau des fiches, des prises et à l'endroit où ils sortent de l'appareil.

SAFETY INSTRUCTIONS

- 10. Power Sources** - The appliance should be connected to a power supply only of the type described in the operating instructions or as marked on the appliance.
Sources d'énergie - Cet appareil doit être connecté à une source d'alimentation du type décrit dans le mode manuel ou tel qu'indiqué sur l'appareil.
- 11. Main Power Disconnect** - The power switch is a single-pole switch. When the switch is in the "Off" position, the appliance is not completely disconnected from the main power. The main power plug is used as the disconnect device and shall remain readily operable. When installing the product, ensure that the plug is easily accessible.
Débranchez l'alimentation principale - L'interrupteur est un interrupteur unipolaire. Lorsque l'interrupteur est en position "Off", l'appareil n'est pas complètement déconnecté de l'alimentation principale. La fiche d'alimentation est utilisée comme dispositif de déconnexion et doit rester facilement accessible. Lors de l'installation du produit, assurez-vous que la prise soit facilement accessible.
- 12. Attachments** - Only use attachments/accessories specified by the manufacturer.
Accessoires - N'utilisez que des fixations / accessoires spécifiés par le fabricant.
- 13. Object and Liquid Entry** - Care should be taken so that objects do not fall and liquids are not spilled into the enclosure through the openings.
Objets et de liquides - Des précautions doivent être prises afin que des objets ne tombent ou que des liquides coulent dans le boîtier à travers les ouvertures.
- 14. Servicing** - The user should not attempt to service the appliance beyond that described in the operating instructions. All other servicing should be referred to qualified service personnel.
Entretien - L'utilisateur ne doit pas tenter de réparer l'appareil au-delà de celle qui est décrite dans le manuel d'instructions. Toutes les réparations doivent être effectuées par un technicien qualifié.

- 15. Damage Requiring Service** - The appliance should be serviced by qualified service personnel when: A. The power supply cord or the plug has been damaged; B. Objects have fallen, liquid has been spilled into the appliance; C. The appliance has been exposed to rain; or D. The appliance does not appear to operate normally; or E. The appliance has been dropped or the enclosure is damaged.
Dommages nécessitant des réparations - L'appareil doit être réparé par un personnel qualifié lorsque: A. Le cordon d'alimentation ou la prise a été endommagé; B. Des objets sont tombés, du liquide a été renversé dans l'appareil C. Si l'appareil a été exposé à pluie; ou D. l'appareil ne semble pas fonctionner normalement, ou E. L'appareil est tombé ou son boîtier est endommagé.

Note: This equipment has been tested and found to comply with the limits for a Class B digital device, pursuant to part 15 of the FCC rules. These limits are designed to provide reasonable protection against harmful interference in a residential installation. This equipment generates, uses and can radiate radio frequency energy and, if not installed and used in accordance with the instructions, may cause harmful interference to radio communications. However, there is no guarantee that interference will not occur in a particular installation. If this equipment does cause harmful interference to radio or television reception, which can be determined by turning the equipment off and on, the user is encouraged to try to correct the interference by one of or more of the following measures: reorient or relocate the receiving antenna; increase the separation between the equipment and receiver; connect the equipment into an outlet on a circuit different from that to which the receiver is connected, or consult the dealer or an experienced radio/TV technician for help.
This Class B digital apparatus complies with Canadian ICES-003. Cet appareil numérique de la classe B est conforme à la norme NMB-003 du Canada.

Laitte on liitettävä suojakoskettimilla varustettuun pistorasiaan (for Finland). Apparatet må tilkoples jordat stikkontakt (for Norway). Apparatet skall anslutas till jordat uttag (for Sweden). Apparatets stikprop skal tilsluttes en stikkontakt med jord, som giver forbindelse til stikproppens jord (for Denmark).
Changes or modifications not expressly approved by the party responsible for compliance could void the user's authority to operate the equipment.

The Russound MBX-PRE is guaranteed against all defects in materials and workmanship for two (2) years from the date of purchase. During this period, Russound will replace any defective parts and correct any defect in workmanship without charge for either parts or labor.

For this warranty to apply, the unit must be installed and used according to its written instructions. If service is necessary, it must be performed by Russound. The unit must be returned to Russound at the owner's expense and with prior written permission from Russound. Accidental damage and shipping damage are not considered defects, nor is damage resulting from abuse or from servicing by an agency or person not specifically authorized in writing by Russound.

This Warranty does not cover:

1. Damage caused by abuse, accident, misuse, negligence, or improper installation or operation
2. Power surges and lightning strikes
3. Normal wear and maintenance
4. Products that have been altered or modified
5. Any product whose identifying number, decal, serial number, etc. has been altered, defaced or removed.

Russound sells products only through authorized Dealers and Distributors to ensure that customers obtain proper support and service. Any Russound product purchased from an unauthorized dealer or other source, including retailers, mail order sellers and online sellers will not be honored or serviced under existing Russound warranty policy. Any sale of products by an unauthorized source or other manner not authorized by Russound shall void the warranty on the applicable product.

Damage to or destruction of components due to application of excessive power voids the warranty on those parts. In these cases, repairs will be made on the basis of the retail value of the parts and labor. To return for repairs, the unit must be shipped to Russound at the owner's expense, along with a note explaining the nature of service required. Be sure to pack the unit in a corrugated container with at least three (3) inches of resilient material to protect the unit from damage in transit.

Before returning a unit for repair, call Russound at (603) 659-5170 for a Return Authorization number. Write this number on the shipping label and ship to:

Russound

Attn: RA# *(Insert your RA number here)*

1955 Wehrle Dr

Williamsville NY 14221

Due to continual efforts to improve product quality as new technology and techniques become available, Russound/FMP, Inc. reserves the right to revise system specifications without notice.



MBX-PRE

Streaming Media Player

Installation Manual

Russound
1 Forbes Road, Newmarket, NH 03857
Telephone: 603.659.5170
Email: tech@russound.com www.russound.com

28-1400 2.26.19. Rev. 20

AirPlay, iPad, iPhone and iPod, are trademarks of Apple Inc., registered in the U.S. and other countries. iPad Air and iPad mini are trademarks of Apple Inc.

Use of the Works with Apple badge means that an accessory has been designed to work specifically with the technology identified in the badge and has been certified by the developer to meet Apple performance standards.

SiriusXM Internet Radio Service is available in the USA, PR or Canada. SiriusXM Internet Radio subscriptions are sold separately and are governed by the Sirius Terms and Conditions (see www.siriusxm.com). Be sure to read this agreement before you purchase your subscription. Sirius, XM and all related marks and logos are trademarks of Sirius XM Radio Inc. and its subsidiaries. All rights reserved.

This product includes some software components that are licensed under the General Public License (GPL). Source code for GPL components is available upon request.

©2016-2018 Russound/FMP, Inc.. All rights reserved. Russound, MBX-Series® and the Russound logo are registered trademarks of Russound/FMP, Inc. All trademarks are the property of their respective owners. Specifications are subject to change without notice.