



UNDER CABINET UNIVERSAL BLUETOOTH MUSIC SYSTEM



USER MANUAL SMPS-628



PLEASE READ THIS USER MANUAL COMPLETELY BEFORE OPERATING
THIS UNIT AND RETAIN THIS BOOKLET FOR FUTURE REFERENCE.

CAUTION

Follow the advice below for safe operations.

- To reduce the risk of fire, do not place any heating or cooking appliance beneath this unit.
- Stop operation immediately if any liquid or solid object should fall into the cabinet.
- If the unit is not to be used for a long period of time, make sure that all power sources are disconnected from the unit. Remove all batteries from the battery compartment, and unplug the AC-DC adaptor from the wall outlet. Make it a practice to remove the AC-DC adaptor by grasping the plug and not by pulling the cord.

ON PLACEMENT

- Do not use the unit in places, which are extremely hot, cold, dusty or humid.
- Install the SMPS-628 as far as possible from a source of noise. (for example, refrigerator, microwave oven, fluorescent lamp, etc.)
- Do not restrict the airflow of the unit by placing it in a place with poor ventilation, by covering it with a cloth or by placing it on a carpet.

Should any trouble occur, remove the power source and refer servicing to qualified personnel.

COMPLIANCE WITH FCC REGULATIONS

This device complies with Part 15 of the FCC Rules. Operation is subject to the following two conditions:

- (1) this device may not cause harmful interference, and
- (2) this device must accept any interference received, including interference that may cause undesired operation.

NOTE : This equipment has been tested and found to comply with the limits for a Class B digital device, pursuant to Part 15 of the FCC Rules. These limits are designed to provide reasonable protection against harmful interference in a residential installation. This equipment generates, uses and can radiate radio frequency energy and, if not installed and used in accordance with the instructions, may cause harmful interference to radio communications. However, there is no guarantee that interference will not occur in a particular installation. If this equipment does cause harmful interference to radio or television reception, which can be determined by turning the equipment off and on, the user is encouraged to try to correct the interference by one or more of the following measures:

- Reorient or relocate the receiving antenna.
- Increase the separation between the equipment and receiver.
- Connect the equipment into an outlet on a circuit different from that to which the receiver is connected.
- Consult the dealer or an experienced radio/TV technician for help.

CAUTION: Changes or modifications not expressly approved by the party responsible for compliance could void the user's authority to operate the equipment.

DEAR JENSEN® CUSTOMER

Selecting fine audio equipment such as the unit you've just purchased is only the start of your musical enjoyment. Now it's time to consider how you can maximize the fun and excitement your equipment offers. This manufacturer and the Electronic Industries Association's Consumer Electronics Group want you to get the most out of your equipment by playing it at a safe level. One that lets the sound come through loud and clear without annoying blaring or distortion and, most importantly, without affecting your sensitive hearing. Sound can be deceiving. Over time your hearing "comfort level" adapts to higher volumes of sound. So what sounds "normal" can actually be loud and harmful to your hearing. Guard against this by setting your equipment at a safe level BEFORE your hearing adapts.

To establish a safe level:

- Start your volume control at a low setting.
- Slowly increase the sound until you can hear it comfortably and clearly, and without distortion.

Once you have established a comfortable sound level:

- Set the dial and leave it there.

Taking a minute to do this now will help to prevent hearing damage or loss in the future. After all, we want you listening for a lifetime.

We Want You Listening For a Lifetime

Used wisely, your new sound equipment will provide a lifetime of fun and enjoyment. Since hearing damage from loud noise is often undetectable until it is too late, this manufacturer and the Electronic Industries Association's Consumer Electronics Group recommend you avoid prolonged exposure to excessive noise.

Customer's Record:

The serial number of this product is found on its back cover. You should note the serial number of this unit in the space provided as a permanent record of your purchase to aid in identification in the event of theft or loss.

Model Number : SMPS-628

Serial Number:

PREPARATION FOR USE

Installing the unit under a cabinet

1. Make the position of the 3 holes by using the supplied template. Use a drill to make the holes.
2. When the cabinet door overhangs the shelf and obstructs the unit, you can adjust the unit/shelf height.
3. Install the unit with the supplied mounting kit.

Unpack the unit carefully to remove all the accessories from the packing. Verify that the following accessories are present before setting up the unit.

Accessories

- Main Unit X 1
- AC adaptor X 1
- User Manual X 1
- Mounting kit X 1

LOCATION OF CONTROLS

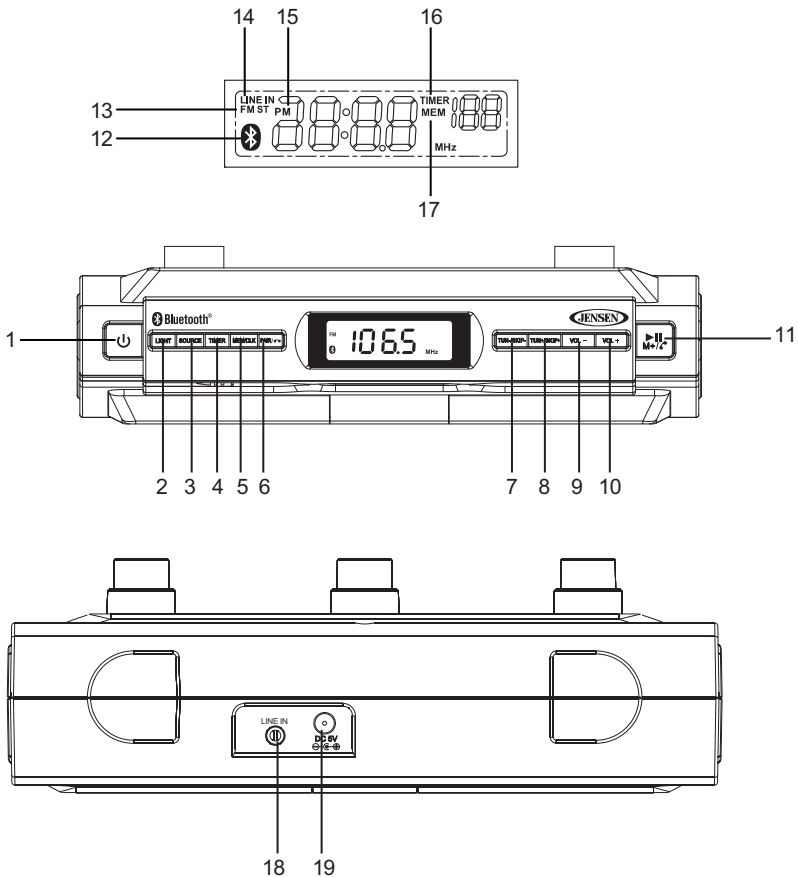

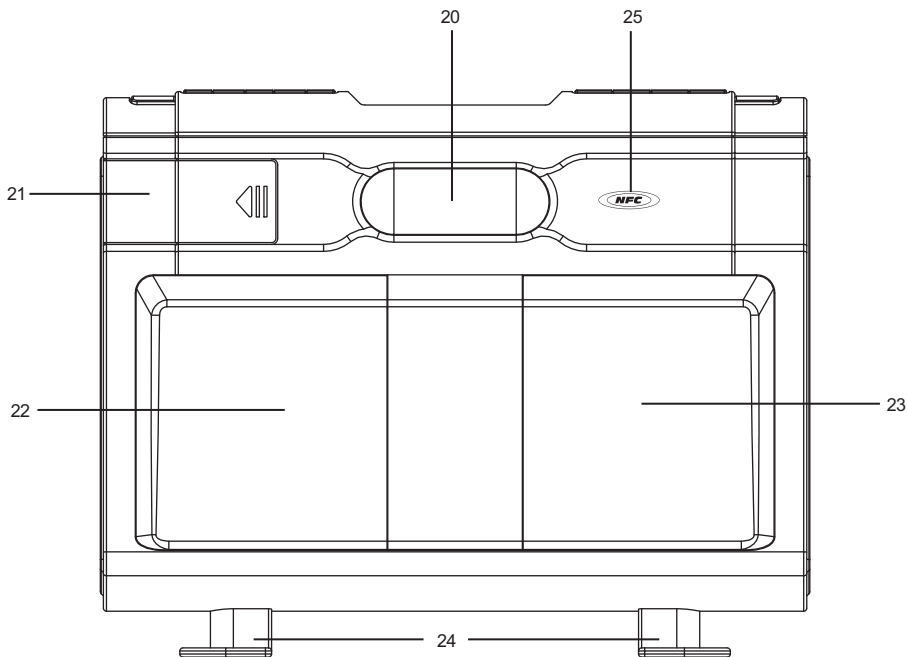

- | | | | |
|----|------------------------|----|---------------------|
| 1 | ⏻ STANDBY BUTTON | 13 | FM INDICATOR |
| 2 | LIGHT BUTTON | 14 | LINE-IN INDICATOR |
| 3 | SOURCE BUTTON | 15 | PM INDICATOR |
| 4 | TIMER BUTTON | 16 | TIMER INDICATOR |
| 5 | MEM / CLK BUTTON | 17 | MEMORY INDICATOR |
| 6 | PAIR / 📶 BUTTON | 18 | LINE IN JACK |
| 7 | TUNE - / SKIP - BUTTON | 19 | DC IN JACK |
| 8 | TUNE + / SKIP + BUTTON | 20 | LED LAMP |
| 9 | VOL - BUTTON | 21 | BATTERY COMPARTMENT |
| 10 | VOL + BUTTON | 22 | SPEAKER (L) |
| 11 | ▶ / M+ / 📶 BUTTON | 23 | SPEAKER (R) |
| 12 | BLUETOOTH 📶 INDICATOR | 24 | CORD WRAP |
| | | 25 | NFC LINKING POINT |

POWER SOURCE

The SMPS-628 operates using the supplied AC Adapter (Operate at 120V ~ 60Hz)

AC ADAPTOR OPERATION

NOTE: Only use the supplied adapter

1. Plug the AC adaptor into normal AC power outlet socket.
2. Insert the DC plug of the AC adaptor cord into the DC IN JACK (#18) at the back of the unit.

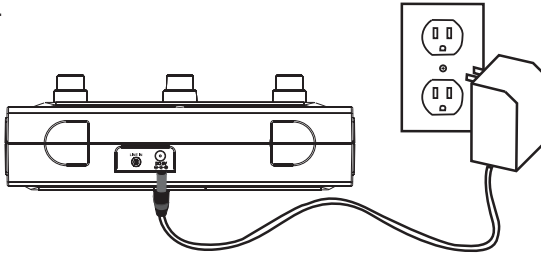

WARNING :

- Before connecting to the power supply, ensure that the supply corresponds to the information on the rating label at the back of the apparatus.
- Be sure that the adapter cord has no slack when using the unit. If the cord has some slack, wrap the extra cord around the Cord Wrap (#24) located on the back of the unit.

INSTALLING BACKUP BATTERIES

1. Remove the Battery Door on the bottom of the unit.
2. Following the polarity diagram as shown inside the battery compartment (#21), insert 2 AAA size batteries (not included) and replace the door.

If power failure occurs, the clock automatically switches to the battery power supply, the clock continue running internally and the radio presets are preserved. When power returns, the unit switches back to AC adaptor again.

NOTE: The display will not exhibit time during power failure but the clock will keep correct time internally.

BATTERY WARNING

1. Be sure that the batteries are installed correctly. Wrong polarity may damage the unit.
2. Use only the size and type of batteries specified.
3. Do not mix old and new batteries.
4. Do not mix alkaline, standard (carbon-zinc) or rechargeable (nickel-cadmium) batteries.
5. For better performance and longer operating time, we recommend the use of alkaline-type batteries.
6. If the unit is not to be used for an extended period of time, remove the batteries. Old or leaking batteries can cause damage to the unit and may void the warranty.
7. Do not try to recharge batteries not intended to be recharged; they can overheat and rupture. (Follow battery manufacturer's directions).
8. Do not dispose of batteries in fire, batteries may leak or explode.

CLOCK SETTING

1. In standby mode, press and hold the MEM / CLK BUTTON (#5). The “12H” will blink.
2. Press the TUN+ / SKIP+ BUTTON (#8) or TUN- / SKIP- BUTTON (#7) to set the 12Hour or 24Hour format.
3. Press the MEM / CLK BUTTON (#5) to confirm. The hour digits will blink.
4. Press the TUN+ / SKIP+ BUTTON (#8) or TUN- / SKIP- BUTTON (#7) to set the current hour.
5. Press the MEM / CLK BUTTON (#5) to confirm. The minute digits will blink.
6. Press the TUN+ / SKIP+ BUTTON (#8) or TUN- / SKIP- BUTTON (#7) to set the current minute.
7. Press the MEM / CLK button to confirm and the Clock Setting is completed.

NOTE:

1. The clock settings may be lost if the adaptor is unplugged and the battery drains after a period of time. If this occurs, you will need to reset the clock.
2. The PM ICON (#15) will light when the 12hour format is selected

TIMER SETTING

In any mode, press the TIMER BUTTON (#4), the TIMER INDICATOR (#16) with time “180” will show on the LCD Display and flash.

1. Press the TIMER BUTTON (#4) repeatedly to adjust the timer in decrements of 10 minutes.
2. Press the TUN+ / SKIP+ BUTTON (#8) or TUN- / SKIP- BUTTON (#7) to adjust the timer in increments / decrements of 1 minute.
3. After the set time is reached, the SMPS-628 alarm will sound.
4. When the alarm sounds, press the  STANDBY BUTTON to stop the alarm.

LISTENING TO THE RADIO



1. Press the  STANDBY BUTTON (#1) to turn on the SMPS-628.
2. Press the SOURCE BUTTON (#3) repeatedly to select FM band, the FM INDICATOR (#13) and frequency will show on the LCD display.
3. Press and hold the TUN+ / SKIP+ BUTTON (#8) or TUN- / SKIP- BUTTON (#7) to search the next/previous available station.
4. If the reception is poor, try manual tuning to fine-tune the station. Press the TUN+ / SKIP+ BUTTON (#8) or TUN- / SKIP- BUTTON (#7) briefly to manually tune through the frequency band.
5. Adjust the VOL + / VOL – (#10/#9) to obtain the desired volume level.

Note :

The LCD display will change to show the clock time after a few seconds. Press the TUN+ / SKIP+ BUTTON (#8) or TUN- / SKIP- BUTTON (#7) to check the tuned frequency.



Setting the Radio Station Presets



The SMPS-628 allows you to store up to 20 stations for easy recall at any time.

1. Press the  STANDBY BUTTON (#1) to turn on the SMPS-628.
2. Press the SOURCE BUTTON (#3) repeatedly to select FM band, the FM INDICATOR (#13) and frequency will show on the LCD display.
3. Press the TUN+ / SKIP+ BUTTON (#8) or TUN- / SKIP- BUTTON (#7) to select the desired station.
4. Press the MEM / CLK BUTTON (#5) to enable the program function and the program number "P01" will show on the LCD display and flashing.
5. Press the TUN+ / SKIP+ BUTTON (#8) or TUN- / SKIP- BUTTON (#7) to select the desired program number of program.
6. Press the MEM / CLK BUTTON (#5) to confirm.
7. Repeat above steps #3 and #6 to preset up to 20 stations.
8. To retrieve one of the preset stations already programmed, press  / M+ /  BUTTON (11) repeatedly until you reach the desired program number of the station.

BLUETOOTH OPERATION

Pairing a Bluetooth enabled device with the SMPS-628.

1. Press the  STANDBY BUTTON (#1) to turn on the SMPS-628.
2. Press the SOURCE BUTTON (#3) repeatedly to select Bluetooth Mode. The BLUETOOTH  INDICATOR will show on the LCD display and flash. The SMPS-628 will enter the Pairing/Discoverable mode.
3. Turn on the Bluetooth function for the device you want to link to, and enable the search or scan function to find the SMPS-628.
4. Select " SMPS-628" from the device list when it appears on your device screen. If required, enter the pass code "0000" to pair (link) the unit with your device.

5. If you are pairing (linking) your computer to the speaker using Bluetooth, you may need to set the SMPS-628 as your computer's default sound device.
6. After successfully pairing (linking) the Bluetooth enable device, the BLUETOOTH  INDICATOR (#12) will stop flashing and remain lit, and a confirmation tone will be heard.
7. If you want to connect the SMPS-628 to another Bluetooth device, press and hold the PAIR /  BUTTON (#6) a few seconds, the BLUETOOTH  INDICATOR (#12) will flash to confirm the SMPS-628 enter the Pairing/Discoverable mode again. Repeat steps 3 and 4.

To connect to a previously paired Bluetooth device



The SMPS-628 can store one previously paired device for quick pairing during power on. When the unit is powered on and the previously paired device is found within the operating range, the unit will pair with the device automatically.

NOTE:

- Due to different operating systems used in Bluetooth devices, the time taken during the pairing process might be different. If pairing is not successful during the first attempt, please try the pairing process again by pressing and holding the PAIR /  button again.
- The pairing time might take a little longer the first time pairing is performed or when pairing a new Bluetooth device.
- Make sure you have the latest firmware for your Bluetooth mobile devices.
- Make sure your device is working properly. Check your device's manual for details on Bluetooth pairing and linking.
- Refer to manual of your cell phones, tablet PC, computer or other Bluetooth enabled device for Bluetooth operation since it may vary from model to model.

PLAYING FROM A BLUETOOTH DEVICE

You can play music from your Bluetooth device wirelessly to the SMPS-628 after pairing.

1. Selecting your favorite song, press the PLAY button on your Bluetooth device or the  /  /  BUTTON (#11) on the SMPS-628 to play or pause the Bluetooth device playback.
2. Adjust both the VOL + / VOL – BUTTONS (#10/#9) on the SMPS-628 and on your Bluetooth device until you reach a comfortable listening level.

Notes:

- 1.) Your Bluetooth enabled device will not play music through the speaker, even if connected (linked) if the device does not support the A2DP profile.
- 2.) Remember to turn off the SMPS-628 when you have finished listening.
- 3.) Don't forget to turn off the power of your external audio device as well.

USING THE SMPS-628 AS A HANDS-FREE SPEAKERPHONE

To use SMPS-628 as a speakerphone for receiving a phone call from a Bluetooth enabled phone.

1. Follow the **“Pairing a Bluetooth enabled device with the SMPS-628”** section above to set up the Bluetooth connection with your smartphone.
2. When a call is received when music is playing, the music will pause, and a ringtone will be heard from the SMPS-628. Press the **▶|| / M+ / 🔊** BUTTON (#11) once to answer the call.
3. Use the VOLUME +/- buttons to adjust the volume level.
4. To ignore an incoming call, simply press the PAIR / 🔊 button, and the call will be ignored.
5. When your call is completed, press the PAIR / 🔊 button once to end the call. If music was playing before answering the call, the music will automatically resume playing when you hang up.
6. Tap the **▶|| / M+ / 🔊** button twice to re-dial the last number you dialed.

CONNECTING YOUR BLUETOOTH DEVICE USING NFC

ABOUT NFC

NFC (Near Field Communication) is a technology enabling short-range wireless communication between various devices, such as mobile phones and IC tags. Thanks to the NFC function, data communication can be achieved easily just by touching the relevant symbol or designated location on NFC compatible devices.

1. Make sure your Smartphone or Bluetooth device has the NFC feature, and it is turned ON (enabled).
2. Touch the back of your smartphone to the NFC linking point (#25) located on the bottom of the unit. Check the owner’s manual of your Bluetooth device to locate the NFC touch point if you are not sure where it is.
3. If the SMPS-628 is in Standby mode, it will turn on and enter Bluetooth mode automatically and pair with your smartphone. If the SMPS-628 is in Radio or LINE-IN mode, it will switch to Bluetooth mode and pair with your smartphone.
4. Some smartphones may ask you to confirm the pairing if they are not paired before.

NOTE: If you have multiple NFC compatible devices to link, just touch the smartphone to a different device to switch the connection to that device. For example, when your smartphone is connected to NFC compatible headphones, just touch the smartphone to the system to change the Bluetooth connection to the system (one touch connection switching).

LINE-IN OPERATION

You can play other music sources (iPod, MP3 or other digital audio players) through the speakers of the SMPS-628 by connecting the LINE-IN Jack (#18) to your external player's audio out jack or headphone jack.

1. Plug one end of an audio cable (not included) into the LINE-IN Jack (#18) and the other end of the cable to the headphone jack of your digital audio player.
2. Turn ON the SMPS-628 and your external audio device.
3. Tap the SOURCE BUTTON (#3) repeatedly to select AUX mode. LINE-IN INDICATOR (#14) will appear on the LCD Display.
4. Start playing the device you plugged into the LINE-IN Jack (#18).
5. Slowly adjust both the volume controls of your SMPS-628 and the external device until you reach a comfortable listening level.

Note :

- If you connect the SMPS-628 to the Line-Out Jack of your external device, you only need to adjust the VOLUME CONTROL of the SMPS-628. If you connect to the Headphone Jack of your external device, you may need to adjust both the volume controls of your external device and the SMPS-628 to obtain the desirable listening level.
- Remember to turn off the SMPS-628 when you have finished listening. Don't forget to turn off the power of your external audio device as well.

RESETTING THE UNIT

If the system does not respond or exhibits erratic or intermittent operation, you may have experienced an electrostatic discharge (ESD) or a power surge that triggered the internal microcontroller to shut down automatically. If this occurs, simply disconnect the AC Adaptor and remove the system back-up battery, wait for at least 3 minutes and then setup the unit again as if you were using it for the very first time.

CARE AND MAINTENANCE

1. Clean the unit with a soft, damp (never wet) cloth. Solvent or detergent should never be used.
2. Avoid operating your unit under direct sunlight or in hot, humid or dusty places to reduce the risk of fire or electric shock.
3. Keep your unit away from heating appliances and sources of electrical noise such as fluorescent lamps or motors.
4. For better Clock Display clarity, avoid operating the unit under direct sunlight or in strong room illumination.
5. Unplug the unit from the electrical power outlet immediately in case of malfunction.

CAUTION: Never allow any water or other liquids to get inside the unit while cleaning.

SPECIFICATIONS

Power Adaptor:	AC input 120V~ 60Hz 10W DC Output 5V 1.2A
Battery Back-up:	2 x DC 1.5V UM-4 type batteries (not included)
Bluetooth:	Bluetooth Specification version 2.1 Support profile A2DP / HFP
Frequency Range:	FM 87.5 – 108 MHz
Audio Power output:	2W (RMS) x2
Dimensions:	6.6 cm (H) x 23.2 cm (W) x 17.0 cm (D)

TROUBLESHOOTING GUIDE

PROBLEM	POSSIBLE CAUSE	REMEDY
The unit does not respond (no power)	The unit is disconnected from the AC outlet.	Reconnect to the AC outlet.
	The AC outlet has not power.	Try the unit on another outlet.
Unit is ON but there is low or no volume	The volume control has been turned all the way down.	Turn the volume control to a higher output.
No sound when playing audio via Bluetooth.	Your Bluetooth device has not been paired properly.	Pairing your Bluetooth device again according to the “BLUETOOTH OPERATION” section.
	The volume control of your Bluetooth device is set at too low.	Increase the volume of your Bluetooth device.
	The volume control of main unit is set at too low.	Increase the volume of main unit to adjust to “+” level.
Noise or sound distorted on FM broadcast	Station not turned properly for FM.	Retune the FM broadcast station.

SPECTRA GREEN NOTICE



At Spectra, environmental and social responsibility is a core value of our business. We are dedicated to continuous implementation of responsible initiatives with an aim to conserve and maintain the environment through responsible recycling.

Please visit us at <http://www.spectraintl.com/green.htm> for more information on Spectra's green initiatives or to find a recycler in your area.

The Bluetooth® word mark and logos are registered trademarks owned by Bluetooth SIG, Inc. and any use of such marks by Spectra Merchandising Intl, Inc. is under license. Other trademarks and trade names are those of their respective owners.

90 DAY LIMITED WARRANTY AND SERVICE VALID IN THE U.S.A ONLY

SPECTRA MERCHANDISING INTERNATIONAL, INC. warrants this unit to be free from defective materials or factory workmanship for a period of 90 days from the date of original customer purchase and provided the product is utilized within the U.S.A. This warranty is not assignable or transferable. Our obligation under this warranty is the repair or replacement of the defective unit or any part thereof, except batteries, when it is returned to the SPECTRA Service Department, accompanied by proof of the date of original consumer purchase, such as a duplicate copy of a sales receipt.

You must pay all shipping charges required to ship the product to SPECTRA for warranty service. If the product is repaired or replaced under warranty, the return charges will be at SPECTRA's expense. There are no other express warranties other than those stated herein.

1. The warranty applies to the SPECTRA product only while:
 - a. It remains in the possession of the original purchaser and proof of purchase is demonstrated.
 - b. It has not been subjected to accident, misuse, abuse, improper service, usage outside the descriptions and warnings covered within the user manual or non-SPECTRA approved modifications.
 - c. Claims are made within the warranty period.
2. This warranty does not cover damage or equipment failure caused by electrical wiring not in compliance with electrical codes or SPECTRA user manual specifications, or failure to provide reasonable care and necessary maintenance as outlined in the user manual.
3. Warranty of all SPECTRA products applies to residential use only and is void when products are used in a nonresidential environment or installed outside the United States.

This warranty gives you specific legal rights, and you may also have other rights which vary from state to state. TO OBTAIN SERVICE please remove all batteries (if any) and pack the unit carefully and send it freight prepaid to SPECTRA at the address shown below. IF THE UNIT IS RETURNED WITHIN THE WARRANTY PERIOD shown above, please include a proof of purchase (dated cash register receipt) so that we may establish your eligibility for warranty service and repair of the unit without cost. Also include a note with a description explaining how the unit is defective. A customer service representative may need to contact you regarding the status of your repair, so please include your name, address, phone number and email address to expedite the process.

IF THE UNIT IS OUTSIDE THE WARRANTY PERIOD, please include a check for \$30.00 to cover the cost of repair, handling and return postage. All out of warranty returns must be sent prepaid.

It is recommended that you contact SPECTRA first at 1-800-777-5331 or by email at custserv@spectraintl.com for updated information on the unit requiring service. In some cases the model you have may be discontinued, and SPECTRA reserves the right to offer alternative options for repair or replacement.

SPECTRA MERCHANDISING INTERNATIONAL, INC.
4230 North Normandy Avenue,
Chicago, IL60634, USA.
1-800-777-5331

To register your product, visit the link on the website below to enter your information.
<http://www.spectraintl.com/wform.htm>