



---

PORTABLE STEREO COMPACT DISC PLAYER WITH  
AM/FM STEREO RADIO AND BLUETOOTH





USER MANUAL  
MODEL CD-560

**Please read this Manual carefully before using the  
unit and retain it for future reference**

# WARNING

TO PREVENT FIRE OR SHOCK HAZARD, DO NOT USE THIS PLUG WITH AN EXTENSION CORD, RECEPTACLE OR OTHER OUTLET UNLESS THE BLADES CAN BE FULLY INSERTED TO PREVENT BLADE EXPOSURE. TO PREVENT FIRE OR SHOCK HAZARD, DO NOT EXPOSE THIS APPLIANCE TO RAIN OR MOISTURE.

 <p>The lightning flash and arrow head within the triangle is a warning sign alerting you of "dangerous voltage" inside the product.</p>	<p><b>CAUTION</b> <b>RISK OF ELECTRIC SHOCK</b> <b>DO NOT OPEN</b></p> <p>CAUTION: TO REDUCE THE RISK OF ELECTRIC SHOCK DO NOT REMOVE COVER (ON BACK), NO USER SERVICEABLE PARTS INSIDE. REFER SERVICING TO QUALIFIED SERVICE PERSONNEL.</p>	 <p>The exclamation point within the triangle is a warning sign alerting you of important instructions accompanying the product.</p>
---	--	---

The Caution Marking is located at the bottom enclosure of the apparatus.

The Rating Plate is located at the bottom enclosure of the apparatus.

## IMPORTANT SAFETY INSTRUCTIONS

1. Read these instructions.
2. Keep these instructions.
3. Heed all warnings.
4. Follow all instructions.
5. Do not use this apparatus near water.
6. Cleaning-Unplug this product from the wall outlet before cleaning. Do not use liquid cleaners or aerosol cleaners. Clean only with dry cloth.
7. Do not block any ventilation openings. Install in accordance with the manufacturer's instructions.
8. Do not place this product on an unstable cart, stand, tripod, bracket, or table. The product may fall, causing serious injury to a child or adult, and serious damage to the product. Use only with a cart, stand, tripod, bracket, or table recommended by the manufacturer, or sold with the product. Any mounting of the product should follow the manufacturer's instructions, and should use a mounting accessory recommended by the manufacturer. A product and cart combination should be moved with care-quick stops, excessive force and uneven surfaces may cause the product and cart combination to overturn.
9. Do not install near any heat sources such as radiators, heat registers, stoves, or other apparatus (including amplifiers) that product heat.
10. Do not defeat the safety purpose of the polarized or grounding-type plug. A polarized plug has two blades with one wider than the other. A grounding type plug has two blades and a third grounding prong. The wide blade or the third prong is provided for your safety. If the provided plug does not fit into your outlet, consult an electrician for replacement of the obsolete outlet.
11. Protect the power cord from being walked on or pinched particularly at plugs, convenience receptacles, and the point where they exit from the apparatus.
12. Only use attachments/accessories specified by the manufacturer.
13. Unplug this apparatus during lightning storms or when unused for a long periods of time.
14. Refer all servicing to qualified service personnel. Servicing is required when the apparatus has been damaged in any way, such as power-supply cord or plug is damaged, liquid has been spilled or objects have fallen into the apparatus, the apparatus has been exposed to rain or moisture, does not operate normally, or has been dropped.



15. This appliance shall not be exposed to dripping or splashing water and that no object filled with liquids such as vases shall be placed on the apparatus.
16. Do not overload wall outlet. Use only power source as indicated.
17. Use replacement part as specified by the manufacturer.
18. Upon completion of any service or repairs to this product, ask the service technician to perform safety checks.
19. Power Sources - This product should be operated only from the type of power source indicated on the marking label. If you are not sure of the type of power supply to your home, consult your product dealer or local power company. For products intended to operate from battery power, or other sources, refer to the operating instruction.
20. Object and Liquid Entry - Never push objects of any kind into this product through openings as they may touch dangerous voltage points or short-out parts that could result in a fire or electric shock. Never spill liquid of any kind on the product.
21. Damage Requiring Service - Unplug this product from the wall outlet and refer servicing to qualified service personnel under the following conditions:
  - a) When the power-supply cord or plug is damaged,
  - b) If liquid has been spilled, or objects have fallen into the product,
  - c) If the product has been exposed to rain or water,
  - d) If the product does not operate normally by following the operating instructions. Adjust only those controls that are covered by the operating instructions as an improper adjustment of other controls may result in damage and will often require extensive work by a qualified technician to restore the product to its normal operation.
  - e) If the product has been dropped or damaged in any way, and
  - f) When the product exhibits a distinct change in performance - this indicates a need for service.
23. Mains plug is used as disconnect device and it should remain readily operable during intended use. In order to disconnect the apparatus from the mains completely, the mains plug should be disconnected from the mains socket outlet completely.
24. Battery shall not be exposed to excessive heat such as sunshine, fire or the like.
25. Excessive sound pressure from earphones and headphone can cause hearing loss.

This symbol indicates that this product incorporates double insulation between hazardous mains voltage and user accessible parts.



**CAUTION:**  
TO PREVENT ELECTRIC SHOCK,  
MATCH WIDE BLADE OF PLUG TO WIDE  
SLOT, FULLY INSERT

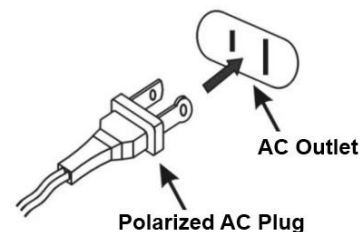

## SAVE THESE INSTRUCTIONS

## CAUTION

### CLASS 1 LASER PRODUCT

CLASS 1 LASER PRODUCT  
APPAREIL À LASER DE CLASSE 1  
PRODUCTO LÁSER DE CLASE 1

**CAUTION**  
INVISIBLE LASER RADIATION  
WHEN OPEN AND INTERLOCKS  
DEFEATED.  
AVOID EXPOSURE TO BEAM.

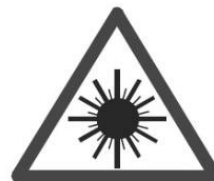

**This product contains a low power laser device.**

Follow the advice below for safe operations.

#### ON PROTECTION AGAINST LASER ENERGY EXPOSURE

- As the laser beam used in this compact disc player is harmful to the eyes, do not attempt to disassemble the casing.
- Stop operation immediately if any liquid or solid object should fall into the cabinet.
- Do not touch the lens or poke at it. If you do, you may damage the lens and the player may not operate properly.
- Do not put anything in the safety slot. If you do, the laser diode will be ON when the CD door is still open.
- If the unit is not to be used for a long period of time, make sure that all power sources are disconnected from the unit. Remove all batteries from the battery compartment, and unplug the AC cord from the wall outlet. Make it a practice to remove the AC cord by grasping the main body and not by pulling the cord.
- This unit employs a laser. The use of controls or adjustment or performance of procedures other than those specified here may result in exposure to hazardous radiation.

Should any trouble occur, remove the power source and refer servicing to qualified personnel.

## COMPLIANCE WITH FCC REGULATIONS

This device complies with Part 15 of the FCC Rules. Operation is subject to the following two conditions:

- (1) This device may not cause harmful interference, and
- (2) This device must accept any interference received, including interference that may cause undesired operation.

This equipment has been tested and found to comply with the limits for a Class B Digital Device, pursuant to Part 15 of the FCC Rules. These limits are designed to provide reasonable protection against harmful interference in a residential installation. This equipment generates, uses and can radiate radio frequency energy and, if not installed and used in accordance with the instructions, may cause harmful interference to radio communications. However, there is no guarantee that interference will not occur in a particular installation. If this equipment does cause harmful interference to radio or television reception, which can be determined by turning the equipment off and on, the user is encouraged to try to correct the interference by one or more of the following measures:

- Reorient or relocate the receiving antenna.
- Increase the separation between the equipment and receiver.
- Connect the equipment into an outlet on a circuit different from that to which the receiver is connected.
- Consult the dealer or an experienced radio/TV technician for help.

### WARNING

Changes or modifications to this unit not expressly approved by the party responsible for compliance could void the user's authority to operate the equipment.

## PROTECT YOUR FURNITURE!!

This system is equipped with non-skid rubber 'feet' to prevent the product from moving when you operate the controls. These 'feet' are made from non-migrating rubber material specially formulated to avoid leaving any marks or stains on your furniture. However certain types of oil based furniture polishes, wood preservatives, or cleaning sprays may cause the rubber 'feet' to soften, and leave marks or a rubber residue on the furniture.

To prevent any damage to your furniture we strongly recommend that you purchase small self-adhesive felt pads, available at hardware stores and home improvement centers everywhere, and apply these pads to the bottom of the rubber 'feet' before you place the product on fine wooden furniture.

## DEAR JENSEN® CUSTOMER

Selecting fine audio equipment such as the unit you've just purchased is only the start of your musical enjoyment. Now it's time to consider how you can maximize the fun and excitement your equipment offers. This manufacturer and the Electronic Industries Association's Consumer Electronics Group want you to get the most out of your equipment by playing it at a safe level. One that lets the sound come through loud and clear without annoying blaring or distortion and, most importantly, without affecting your sensitive hearing. Sound can be deceiving. Over time your hearing "comfort level" adapts to higher volumes of sound. So what sounds "normal" can actually be loud and harmful to your hearing. Guard against this by setting your equipment at a safe level BEFORE your hearing adapts.

To establish a safe level:

- Start your volume control at a low setting.
- Slowly increase the sound until you can hear it comfortably and clearly, and without distortion.
- Once you have established a comfortable sound level : Set the dial and leave it there.

Taking a minute to do this now will help to prevent hearing damage or loss in the future. After all, we want you listening for a lifetime.

### We Want You Listening For a Lifetime

Used wisely, your new sound equipment will provide a lifetime of fun and enjoyment. Since hearing damage from loud noise is often undetectable until it is too late, this manufacturer and the Electronic Industries Association's Consumer Electronics Group recommend you avoid prolonged exposure to excessive noise.



### Customer's Record:

The serial number of this product is found on its bottom cover. You should note the serial number of this unit in the space provided as a permanent record of your purchase to aid in identification in the the event of theft of loss.

Model Number : CD-560

Serial Number :

# LOCATION OF CONTROLS

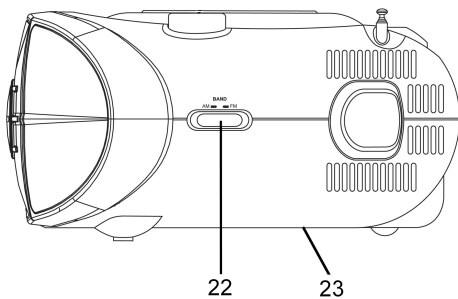
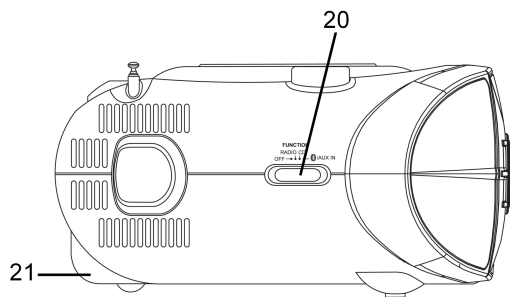
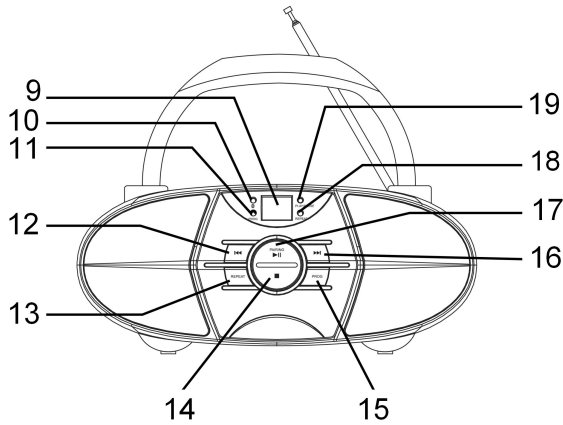
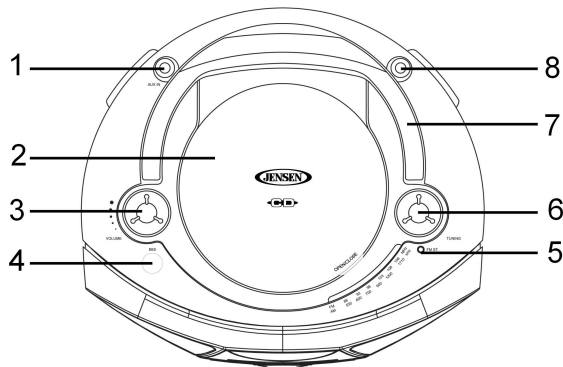

- 1 AUX IN JACK
- 2 CD DOOR
- 3 VOLUME KNOB
- 4 BASS BOOST BUTTON
- 5 FM STEREO INDICATOR
- 6 TUNING KNOB
- 7 HANDLE
- 8 FM ANTENNA
- 9 LED DISPLAY
- 10 BLUETOOTH INDICATOR
- 11 PROGRAM INDICATOR
- 12 SKIP/SEARCH BACKWARD BUTTON
- 13 REPEAT BUTTON
- 14 STOP BUTTON
- 15 PROGRAM BUTTON
- 16 SKIP/SEARCH FORWARD BUTTON
- 17 PAIRING, PLAY/PAUSE BUTTON
- 18 REPEAT INDICATOR
- 19 PLAY/PAUSE INDICATOR
- 20 FUNCTION SELECTOR
- 21 AC POWER SOCKET
- 22 BAND SELECTOR
- 23 BATTERY COMPARTMENT

## POWER SOURCES

The CD-560 operates using standard 120V~ 60Hz AC household power or 8 x "C" size (UM-2) batteries (Not included).

### A. BATTERY OPERATION

For best performance and longer operating time, we recommend the use of alkaline batteries.

1. Remove the Battery Door.
2. Following the polarity (+ and -) diagram as shown inside the battery compartment, insert 8 'C' size (UM-2) batteries.
3. Replace the Battery Door.

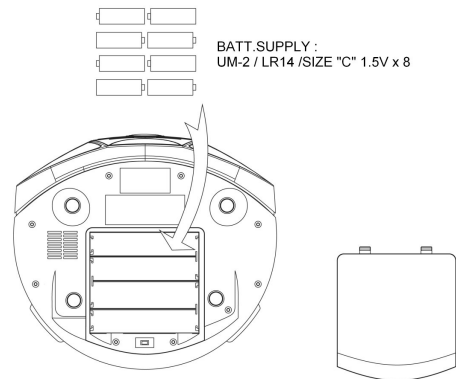

### BATTERY WARNING

1. Be sure that the batteries are installed correctly. Wrong polarity may damage the unit.
2. (a) Do not mix old and new batteries.  
(b) Do not mix alkaline, standard (carbon-zinc) or rechargeable (nickel-cadmium) batteries.
3. If the unit is not to be used for an extended period of time, remove the batteries. Old or leaking batteries can cause damage to the unit and may void the warranty.
4. Do not dispose of batteries in fire, batteries may explode or leak.
5. Do not try to recharge batteries not intended to be recharged; they can overheat and rupture. ( Follow battery manufacturer's directions ).

### B. AC POWER CONNECTION

1. Insert one end of power cord to the AC Socket (#21) at the back of the CD-560.
2. Connect the power cord to AC power source.
3. When the unit is operated from AC power source, the internal battery source will automatically be disconnected.

## RADIO RECEPTION

1. Set the Function Selector (#20) to "RADIO". The POWER Indicator (#12) will light
2. Set the Band Selector (#22) to "AM" or "FM" for the desired radio band.
3. Turn the Tuning Knob (#6) to select the desired radio station.
4. Adjust the Volume Control (#3) to obtain the desired sound level from the Built-in Speakers.
5. To turn the Radio off, set the Function Selector (#20) to the "OFF" position.

### TIPS FOR BEST RECEPTION

AM – The AM antenna is located inside the cabinet of the unit. If AM reception is weak, change the position of unit until the internal antenna picks up the strongest signal.

FM – If a stereo broadcast program is being received, the FM STEREO INDICATOR (#5) will light. During FM or FM Stereo reception, always keep the FM TELESCOPIC ANTENNA (#8) fully extended for best performance. However, if FM reception is weak, try repositioning the unit near an open window until you get the best reception.

## CD OPERATION

**NOTE:** THIS UNIT NOT ONLY PLAYS COMMERCIAL COMPACT DISCS BUT ALSO SELF-COMPILED CD-RW DISCS.

### Notes on CD-R/RW Discs

- Because of the non-standardized format definition/production of CD-R/RW recordings, playback quality & performance is not guaranteed.
- Manufacturer is not responsible for the playback of CD-R/RW discs due to recording conditions such as PC performance, writing software, media properties etc.
- Do not attach a label or seal to either side of the CD-R/RW disc. It may cause a malfunction.

### PLAYING A CD

1. Open the CD Door (#2) by pressing down where the OPEN/CLOSE is indicated on the CD Door (#2).
2. Carefully place an audio CD with its label side upward in the CD compartment and close the CD Door by pressing on the CD Door (#2) where OPEN/CLOSE is indicated on the CD Door (#2).
3. Set the Function Selector (#20) to the CD position. The LED Display (#9) will briefly display flashing "- -" and the total number of tracks on the CD will appear on the LED Display (#9) after a few seconds.
4. Press the Play/Pause  Button (#7). The CD will start playing from the first track. The Play/Pause Indicator (#19) will light steadily.



5. Adjust the Volume Control (#3) to obtain the desired sound level from the Built-in Speakers.
6. To pause playback, press the Play/Pause ►|| Button (#17). The Play/Pause Indicator (#19) will flash. To resume playing, press the Play/Pause ►|| Button (#17) again.
7. You can choose to play your favorite track directly by pressing either the Skip/Search Forward ►►| Button (#16) or Skip/Search Backward |◄◄ Button (#12). The LED Display (#9) will indicate the correct track number selected.
8. To locate a particular section within a track, press and hold the Skip/Search Forward ►►| Button (#16) or Skip/Search Backward |◄◄ Button (#12) until the section is found. Release the button to continue playing your selection.  
( The SEARCH function does not apply to Bluetooth operation. )
9. To stop playing, press the Stop ■ Button (#14).
10. When you wish to turn off the CD Player, set the Function Selector (#20) to the "OFF" position.

## REPEAT MODE

### REPEAT 1

When the REPEAT button (#13) is pressed once, the Repeat Indicator (#18) will light and flash. The current track will be played repeatedly.

### REPEAT ALL

When the REPEAT button (#13) is pressed twice, the repeat indicator (#18) will light steadily. The whole disc will be played repeatedly.

## CD PROGRAM PLAY MODE

This function allows the CD tracks to be played in programmed sequence.

NOTE: Program can only be set in STOP mode.

1. Load the CD Disc you wish to program.
2. Make sure the unit is in STOP mode.
3. Press the Program Button (#15) once, location "01" will show on the LED Display (#9) and the "PROG" indicator (#11) will blink.
4. Press Skip/Search Forward ►►| Button (#16) or Skip/Search Backward |◄◄ Button (#12) until the desired track number is reached.
5. Press the Program Button (#15) to store the selection.
6. Repeat the (4) & (5) steps until you have entered all the tracks you want to program.
7. To play the stored sequence, press the Play/Pause ►|| Button (#17).
8. After all memory tracks have been played, the CD will stop automatically.

**NOTE:**

1. When 20 tracks of CD music have been programmed, the memory is full. The programmed tracks' numbers will show on the LED display sequentially. Then the location "01" show on LED Display and flash. You can press Play/Pause to start the program playback. Or repeat the (4) & (5) steps to change the track number you wish.
2. If you want to cancel the program memory, press the STOP Button (#14) twice during playback or once in STOP mode.

The Repeat function also applies to programmed track playback.

**To Repeat Programmed Tracks**

1. During program play, press REPEAT button (#13) once will repeat the specifically programmed tracks.
2. Press the REPEAT button (#13) again will repeat all the programmed tracks.
3. Press the STOP Button (#14) twice to cancel program playback.

## **AUX IN operation**

You can play other music sources (iPod, MP3 or other digital audio players) through the speakers of this unit by connecting the AUX IN Jack (#1) to your external player's audio out jack or headphone jack.





1. Plug one end of an audio cable (not included) into the AUX IN Jack (#1) and the other end of the cable to the headphone jack of your digital audio player.
2. Set the Function Selector (#20) to /AUX IN.
3. Start playing the device you plugged into the AUX IN Jack (#1).
4. Slowly adjust both the volume controls of your CD-560 and the external device until you reach a comfortable listening level.
5. Turn off your iPod, MP3 player etc. when finish listening.
6. Set the Function Selector (#20) to the "OFF" position to turn CD-560 off and unplug the AUX IN Jack.

**Note :**





- If you connect CD-560 to the Line-Out Jack of your external device, you only need to adjust the VOLUME CONTROL of your CD-560. If you connect to the Headphone Jack of your external device, you may need to adjust both the volume controls of your external device and CD-560 to obtain the desirable listening level.
- Remember to turn off the CD-560 when you have finished listening. Don't forget to switch off the power of your external audio device as well.

## PLAYING FROM A BLUETOOTH DEVICE

Pairing a Bluetooth enabled device with the CD-560.

1. Set the Function Selector (#20) to the /AUX IN position. The BLUETOOTH  INDICATOR (#10) will flash slowly and “Dew Drop” sound will be heard. ( Make sure no audio cable is connected to the AUX IN jack )
2. Turn on the Bluetooth function of your device and enable the search or scan function to find the CD-560.
3. Select "CD-560" from the device list when it appears on your device screen. If required, enter the pass code “0000” to pair (link) CD-560 with your device.
4. If you are pairing (linking) your computer to the speaker using Bluetooth, you may need to set the CD-560 as your computer’s default sound device.
5. After pairing CD-560 with your Bluetooth device successfully, The  INDICATOR (#10) will light steadily.
6. If you want CD-560 change to pair with another Bluetooth device, press and hold Pairing, Play/Pause  Button (#17) 5 seconds. The  INDICATOR (#10) will flash and “Dew Drop” sound will be heard. CD-560 will go into Pairing/Discoverable mode. Repeat steps 2 & 3.

Now you can play music from your Bluetooth device wirelessly to CD-560.

1. Selecting your favorite song, press Play/Pause  Button on your Bluetooth device or Play/Pause  Button (#17) on CD-560 to play or pause the Bluetooth device playback.
2. Press Skip Forward  Button (#16) or Skip Backward  Button (#12) to select the Next or Previous track. ( The SEARCH function does not apply to Bluetooth operation )
3. Slowly adjust both the volume controls of your CD-560 and your Bluetooth device until you reach a comfortable listening level.

Note :

1. Refer to the manual of your cell phone, tablet PC, computer or other Bluetooth enabled devices for Bluetooth operation since it may vary from model to model.
2. If your Bluetooth enabled device does not support A2DP profile, it will not play the music through the speaker, even if paired (linked).
3. Remember to turn off the CD-560 when you have finished listening, set the Function Selector (#20) to the “OFF” position
4. Don't forget to switch off the power of your external audio device as well.

## BASS BOOST OPERATION

1. To enhance the low frequency sound, press the BBS BUTTON (#4) once (button in) to activate.
2. Press the BBS Button (#4) again (button out) to turn the Bass Boost off.

## CARE AND MAINTENANCE

1. Clean your unit with a damp (never wet) cloth. Solvent or detergent should never be used.
2. Avoid leaving your unit in direct sunlight or in hot, humid or dusty places.
3. Keep your unit away from heating appliances and sources of electrical noise such as fluorescent lamps or motors.
4. If drop-outs or interruptions occur in the music during CD play, or if the CD fails to play at all, its bottom surface may require cleaning. Before playing, wipe the disc from the center outwards with a good soft cleaning cloth.

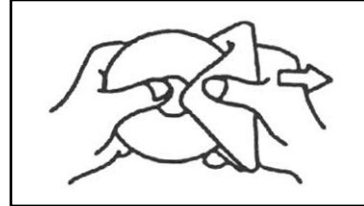

## TROUBLE SHOOTING

If you experience difficulties in the use of this music system please check the following or call **1-800-777-5331** for Customer Service and Support.

PROBLEM	POSSIBLE CAUSE	REMEDY
No sound in general	Volume not adjusted. Mains supply is not correctly connected.	Adjust the Volume knob. Connect the mains supply properly.
The unit does reset to operation of any button	Under the influence of electrostatic phenomenon, the product may malfunction and require user to disconnect.	Turn off the unit, disconnect the mains plug, and reconnect after a few seconds.
Radio poor reception	Weak radio aerial signal. Interference caused by the vicinity of electrical equipment like TVs, video recorders, computer, thermostats, fluorescent lamps (TL) engines etc.	Aim the aerial for best reception: Fully extend the telescopic antenna. Keep the unit away from electrical equipment.
CD cannot read	The disc is dirty The disc is upside down. The CD player is in Pause mode	Clean or replace the disc. Turn it over so that the label is face up. Release the Pause Mode by pressing the Play/Pause button.
No sound when playing audio via Bluetooth	Your Bluetooth device has been paired	According to the "Bluetooth operation"
	The volume control of your Bluetooth device is set at too low.  The volume control of main unit is set at too low.	Increase the volume of your Bluetooth device. Increase the volume of main unit to adjust the VOLUME control.

## TECHNICAL SPECIFICATION

Power Supply	AC120V~60Hz
Battery Size	UM-2 or C-Size Batteries x 8 pcs
Power consumption	16 W
Dimensions (H × W × D)	135mm x 330mm x 230mm
Net Weight	1.215 kg
Radio Frequency Coverage	FM: 87.5 – 108MHz    AM: 530 – 1710 KHz
Speaker Power Output	2 X 1.5W RMS
Speakers impedance	8 Ohms

**IMPORTANT:** Due to continual revision and improvement on our products design, specifications are subject to change without further notice.

## SPECTRA GREEN NOTICE



At Spectra, environmental and social responsibility is a core value of our business. We are dedicated to continuous implementation of responsible initiatives with an aim to conserve and maintain the environment through responsible recycling.

Please visit us at <http://www.spectrainl.com/green.htm> for more information on Spectra's green initiatives or to find a recycler in your area.

Bluetooth<sup>®</sup> is a registered trademark of Bluetooth SIG, Inc.

## 90 DAY LIMITED WARRANTY AND SERVICE VALID IN THE U.S.A. ONLY

SPECTRA MERCHANDISING INTERNATIONAL, INC. warrants this unit to be free from defective materials or factory workmanship for a period of 90 days from the date of original customer purchase and provided the product is utilized within the U.S.A. This warranty is not assignable or transferable. Our obligation under this warranty is the repair or replacement of the defective unit or any part thereof, except batteries, when it is returned to the SPECTRA Service Department, accompanied by proof of the date of original consumer purchase, such as a duplicate copy of a sales receipt.

You must pay all shipping charges required to ship the product to SPECTRA for warranty service. If the product is repaired or replaced under warranty, the return charges will be at SPECTRA's expense. There are no other express warranties other than those stated herein.

This warranty is valid only in accordance with the conditions set forth below:

1. The warranty applies to the SPECTRA product only while:
  - a. It remains in the possession of the original purchaser and proof of purchase is demonstrated.
  - b. It has not been subjected to accident, misuse, abuse, improper service, usage outside the descriptions and warnings covered within the user manual or non-SPECTRA approved modifications.
  - c. Claims are made within the warranty period.
2. This warranty does not cover damage or equipment failure caused by electrical wiring not in compliance with electrical codes or SPECTRA user manual specifications, or failure to provide reasonable care and necessary maintenance as outlined in the user manual.
3. Warranty of all SPECTRA products applies to residential use only and is void when products are used in nonresidential environment or installed outside the United States.

This warranty gives you specific legal rights, and you may also have other rights which vary from state to state. TO OBTAIN SERVICE please remove all batteries (if any) and pack the unit carefully and send it freight prepaid to SPECTRA at the address shown below. IF THE UNIT IS RETURNED WITHIN THE WARRANTY PERIOD shown above, please include a proof of purchase (dated cash register receipt) so that we may establish your eligibility for warranty service and repair of the unit without cost. Also include a note with a description explaining how the unit is defective. A customer service representative may need to contact you regarding the status of your repair, so please include your name, address, phone number and email address to expedite the process.

IF THE UNIT IS OUTSIDE THE WARRANTY PERIOD, please include a check for **\$30.00** to cover the cost of repair, handling and return postage. All out of warranty returns must be sent prepaid.

It is recommended that you contact SPECTRA first at 1-800-777-5331 or by email at [custserv@spectraintl.com](mailto:custserv@spectraintl.com) for updated information on the unit requiring service. In some cases the model you have may be discontinued, and SPECTRA reserves the right to offer alternative options for repair or replacement.

SPECTRA MERCHANDISING INTERNATIONAL, INC.  
4230 North Normandy Avenue,  
Chicago, IL60634, USA. 1-800-777-5331

To register your product, visit the link on the website below to enter your information.  
<http://www.spectraintl.com/wform.htm>

1213

Made in China