

OMRON®

INSTRUCTION MANUAL

5 series Upper Arm Blood Pressure Monitor

Model BP7200



All for Healthcare

ENGLISH

Table of Contents

| | |
|---|----|
| Introduction | 3 |
| Important Safety Information | 5 |
| 1. Know Your Monitor | 10 |
| 2. Preparation | 18 |
| 3. Using Your Monitor | 25 |
| 4. Using Memory Function | 28 |
| 5. Other Settings | 30 |
| 6. Error Messages and Troubleshooting | 32 |
| 7. Maintenance | 36 |
| 8. Optional Accessories | 38 |
| 9. Specifications | 40 |
| 10. FCC Statement | 43 |
| 11. Limited Warranty | 44 |
| 12. Guidance and Manufacturer's Declaration | 46 |

Introduction

Thank you for purchasing the OMRON BP7200 Blood Pressure Monitor. This monitor can be used by multiple users. This blood pressure monitor uses the oscillometric method of blood pressure measurement. This means this monitor detects your blood movement through your brachial artery and converts the movements into a digital reading.

Safety Instructions

This instruction manual provides you with important information about the OMRON BP7200 Blood Pressure Monitor. To ensure the safe and proper use of this monitor, READ and UNDERSTAND all of these instructions. **If you do not understand these instructions or have any questions, contact 1-800-634-4350 before attempting to use this monitor. For specific information about your own blood pressure, consult with your physician.**

Intended Use

This device is a digital monitor intended for use in measuring blood pressure and pulse rate in adult patient population. The device detects the appearance of irregular heartbeats during measurement and gives a warning signal with readings.

Environments of Use: Home

Patient Population: Adult

Receiving and Inspection

Remove this monitor and other components from the packaging and inspect for damage. If this monitor or any other components is damaged, DO NOT USE and contact 1-800-634-4350.

Symbols Glossary

For symbol information, visit:

OmronHealthcare.com/symbols-glossary

Contraindications

- This monitor is contraindicated for use in ambulatory environments.
 - This monitor is contraindicated for use on aircraft.
-

Important Safety Information

Read the Important Safety Information in this instruction manual before using this monitor.

Follow this instruction manual thoroughly for your safety.

Keep for future reference. For specific information about your own blood pressure, **CONSULT WITH YOUR PHYSICIAN.**

Warning

Indicates a potentially hazardous situation which, if not avoided, could result in death or serious injury.

- **DO NOT use this monitor on infants, toddlers, children or persons who cannot express themselves.**
- **DO NOT adjust medication based on readings from this blood pressure monitor. Take medication as prescribed by your physician. ONLY a physician is qualified to diagnose and treat high blood pressure.**
- **DO NOT use this monitor on an injured arm or an arm under medical treatment.**
- **DO NOT apply the arm cuff on your arm while on an intravenous drip or blood transfusion.**
- **DO NOT use this monitor in areas containing high frequency (HF) surgical equipment, magnetic resonance imaging (MRI) equipment, computerized tomography (CT) scanners. This may result in incorrect operation of the monitor and/or cause an inaccurate reading.**
- **DO NOT use this monitor in oxygen rich environments or near flammable gas.**
- **Consult with your physician before using this monitor if you have common arrhythmias such as atrial or ventricular premature beats or atrial fibrillation; arterial sclerosis; poor perfusion; diabetes; pregnancy; pre-eclampsia or renal disease. NOTE that any of these conditions in addition to patient motion, trembling, or shivering may affect the measurement reading.**

- **NEVER** diagnose or treat yourself based on your readings. **ALWAYS** consult with your physician.
- To help avoid strangulation, keep the air tube and AC adapter cable away from infants, toddlers and children.
- This product contains small parts that may cause a choking hazard if swallowed by infants, toddlers and children.

AC Adapter (optional accessory) Handling and Usage

- **DO NOT** use the AC adapter if this monitor or the AC adapter cable is damaged. If this monitor or the cable is damaged, turn off the power and unplug the AC adapter immediately.
- Plug the AC adapter into the appropriate voltage outlet. **DO NOT** use in a multi-outlet plug.
- **NEVER** plug in or unplug the AC adapter from the electric outlet with wet hands.
- **DO NOT** disassemble or attempt to repair the AC adapter.

Battery Handling and Usage

- Keep batteries out of the reach of infants, toddlers and children.
-

 **Caution** Indicates a potentially hazardous situation which, if not avoided, may result in minor or moderate injury to the user or patient, or cause damage to the equipment or other property.

- **Stop using this monitor and consult with your physician if you experience skin irritation or discomfort.**
- **Consult with your physician before using this monitor on an arm where intravascular access or therapy, or an arterio-venous (A-V) shunt, is present because of temporary interference to blood flow which could result in injury.**
- **Consult with your physician before using this monitor if you have had a mastectomy.**
- **Consult with your physician before using this monitor if you have severe blood flow problems or blood disorders as cuff inflation can cause bruising.**
- **DO NOT** take measurements more often than necessary because bruising, due to blood flow interference, may occur.

- **ONLY** inflate the arm cuff when it is applied on your upper arm.
- Remove the arm cuff if it does not start deflating during a measurement.
- **DO NOT** use this monitor for any purpose other than measuring blood pressure.
- During measurement, make sure that no mobile device or any other electrical device that emits electromagnetic fields is within 12 inches (30 cm) of this monitor. This may result in incorrect operation of the monitor and/or cause an inaccurate reading.
- **DO NOT** disassemble or attempt to repair this monitor or other components. This may cause an inaccurate reading.
- **DO NOT** use in a location where there is moisture or a risk of water splashing this monitor. This may damage this monitor.
- **DO NOT** use this monitor in a moving vehicle such as in a car.
- **DO NOT** drop or subject this monitor to strong shocks or vibrations.
- **DO NOT** use this monitor in places with high or low humidity or high or low temperatures. Refer to section 9.
- During measurement, observe the arm to ensure that the monitor is not causing prolonged impairment to blood circulation.
- **DO NOT** use this monitor in high-use environments such as medical clinics or physician offices.
- **DO NOT** use this monitor with other medical electrical (ME) equipment simultaneously. This may result in incorrect operation of the monitor and/or cause an inaccurate reading.
- Avoid bathing, drinking alcohol or caffeine, smoking, exercising and eating for at least 30 minutes before taking a measurement.
- Rest for at least 5 minutes before taking a measurement.
- Remove tight-fitting or thick clothing from your arm while taking a measurement.
- Remain still and **DO NOT** talk while taking a measurement.
- **ONLY** use the arm cuff on persons whose arm circumference is within the specified range of the cuff.

- **Ensure that this monitor has acclimated to room temperature before taking a measurement. Taking a measurement after an extreme temperature change could lead to an inaccurate reading. OMRON recommends waiting for approximately 2 hours for the monitor to warm up or cool down when the monitor is used in an environment within the temperature specified as operating conditions after it is stored either at the maximum or at the minimum storage temperature. For additional information on operating and storage/transport temperature, refer to section 9.**
- **DO NOT use this monitor after the durable period has ended. Refer to section 9.**
- **DO NOT crease the arm cuff or the air tube excessively.**
- **DO NOT fold or kink the air tube while taking a measurement. This may cause an injury by interrupting blood flow.**
- **To unplug the air plug, pull on the plastic air plug at the base of the tube, not the tube itself.**
- **ONLY use the AC adapter, arm cuff, batteries and accessories specified for this monitor. Use of unsupported AC adapters, arm cuffs and batteries may damage and/or may be hazardous to this monitor.**
- **ONLY use the approved arm cuff for this monitor. Use of other arm cuffs may result in incorrect readings.**
- **Inflating to a higher pressure than necessary may result in bruising of the arm where the cuff is applied. NOTE: refer to “If your systolic pressure is more than 210 mmHg” in section 3 of this instruction manual for additional information.**

AC Adapter (optional accessory) Handling and Usage

- Fully insert the AC adapter into the outlet.
- When unplugging the AC adapter from the outlet, be sure to safely pull from the AC adapter. **DO NOT** pull from the AC adapter cable.
- When handling the AC adapter cable:
 - DO NOT damage it.
 - DO NOT break it.
 - DO NOT tamper with it.
 - DO NOT forcibly bend or pull it.
 - DO NOT twist it.
 - DO NOT use it if it is gathered in a bundle.
 - DO NOT pinch it.
 - DO NOT place it under heavy objects.
- Wipe any dust off of the AC adapter.
- Unplug the AC adapter when not in use.
- Unplug the AC adapter before cleaning this monitor.

Battery Handling and Usage

- **DO NOT** insert batteries with their polarities incorrectly aligned.
 - **ONLY** use 4 “AA” alkaline or manganese batteries with this monitor. **DO NOT** use other types of batteries. **DO NOT** use new and used batteries together. **DO NOT** use different brands of batteries together.
 - Remove batteries if this monitor will not be used for a long period of time.
 - If battery fluid should get in your eyes, immediately rinse with plenty of clean water. Consult with your physician immediately.
 - If battery fluid should get on your skin, wash your skin immediately with plenty of clean, lukewarm water. If irritation, injury or pain persists, consult with your physician.
 - **DO NOT** use batteries after their expiration date.
 - Periodically check batteries to ensure they are in good working condition.
-

1. Know Your Monitor

1.1 Contents/Product Includes

Monitor, 4 “AA” batteries, Wide-Range D-Ring Cuff, instruction manual, quick start guide

1.2 Monitor and Arm Cuff

Front of the monitor

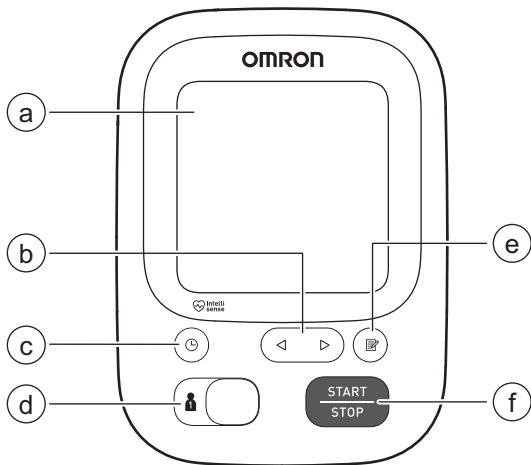

- (a) Display
- (b) [Forward/Backward] buttons
- (c) [Date/Time setting] button
- (d) [User ID selection] switch
- (e) [Memory] button
- (f) [START/STOP] button

Left side, back and bottom of the monitor

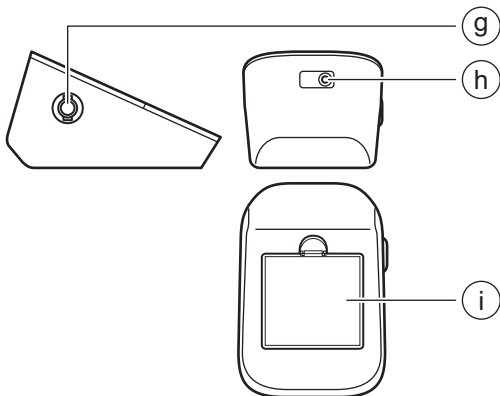

- ⓐ Air jack
- ⓑ AC adapter jack
(for optional AC adapter)
- ⓒ Battery compartment

Arm cuff





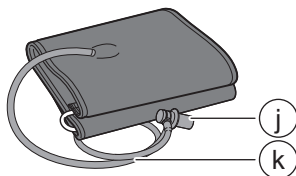

(Upper arm circumference: 9" - 17" (22 - 42 cm))

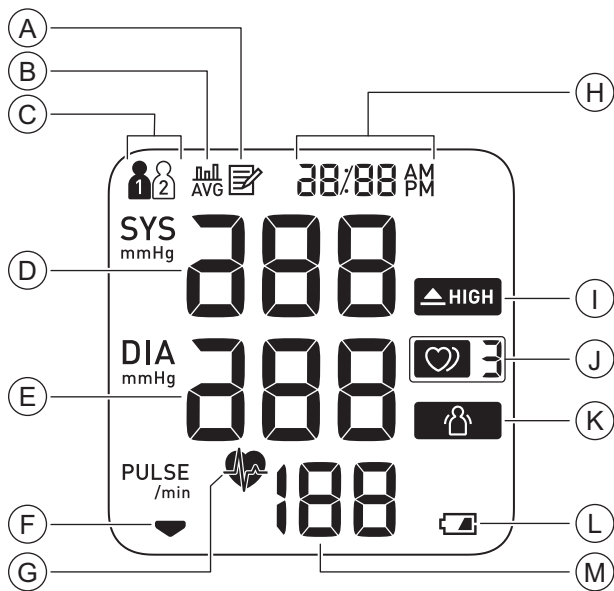
- ⓓ Air plug
- ⓔ Air tube



1.3 Display and Symbols



| | | |
|---|---|--|
| Ⓐ |  | Memory symbol Appears when viewing readings stored in the memory. |
| Ⓑ |  | Average value symbol Flashes when viewing the average of the latest 2 or 3 readings taken within the most recent 10 minute timeframe. |
| Ⓒ |  | User ID symbol The user ID number appears when selecting the user with [user ID selection] switch. |
| Ⓓ | Systolic blood pressure reading | |
| Ⓔ | Diastolic blood pressure reading | |
| Ⓕ |  | Deflation symbol Appears during cuff deflation. |
| Ⓖ |  | Heartbeat symbol Flashes while taking a measurement. |
| Ⓗ | Date / Time display | |
| Ⓘ |  | High symbol Appears if your systolic blood pressure is ≥ 130 mmHg or the diastolic blood pressure is ≥ 80 mmHg. Refer to sub-section 1.4 for more information. |

Irregular heartbeat symbol

Appears when irregular rhythm is detected 2 or more times during a measurement. The symbol with the number appears as below:

Irregular heartbeat is detected 2 times: 

Irregular heartbeat is detected 3 times or more: 







An irregular heartbeat rhythm is defined as a rhythm that is 25 % less or 25 % more than the average rhythm detected while your monitor is measuring blood pressure.



Irregular heartbeat symbol may be displayed when the monitor detects arm movements. Refer to section 6 for more information.

If it continues to appear, we recommend you to consult with and follow the directions of your physician.

| | | |
|------------|---|---|
| <p>(K)</p> |  | <p>Movement error symbol Appears with your reading when your body is moving during a measurement. If it appears, remove the arm cuff and wait for 2 to 3 minutes. Then, reapply the cuff, remain still and take another measurement.</p> |
| <p>(L)</p> |  | <p>Low battery symbol Flashes when batteries are low.</p> |
| |  | <p>Depleted battery symbol Appears when batteries are depleted.</p> |
| <p>(M)</p> | <p>Pulse display / Memory number Pulse rate appears after the measurement. When pressing the  button, the memory number appears for approximately 1.5 seconds before the pulse rate shows again on the display.</p> | |

1.4 Classification of BP (Blood Pressure)

ACC/AHA 2017 Hypertension guidelines define categories of BP in adults as below.

Categories of BP in Adults*

| BP Category | Systolic BP | Diastolic BP |
|---------------------|----------------|-----------------|
| Normal | < 120 mmHg | and < 80 mmHg |
| Elevated | 120 - 129 mmHg | and < 80 mmHg |
| Hypertension | | |
| Stage 1 | 130 - 139 mmHg | or 80 - 89 mmHg |
| Stage 2 | ≥ 140 mmHg | or ≥ 90 mmHg |

* Individuals with Systolic BP and Diastolic BP in 2 categories should be designated to the higher BP category.

BP indicates blood pressure (based on an average of ≥ 2 careful readings obtained on ≥ 2 occasions).

Source: ACC/AHA 2017 High Blood Pressure Clinical Practice Guideline

⚠ Warning

- NEVER diagnose or treat yourself based on your readings. ALWAYS consult with your physician.

2. Preparation

2.1 Installing Batteries

1. Push down on the hook of the battery cover and pull upward.

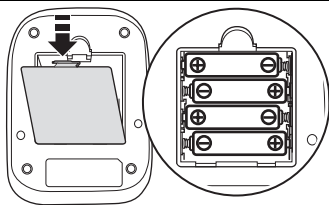

2. Insert 4 “AA” batteries as indicated in the battery compartment.

3. Close the battery cover.

As soon as batteries are correctly installed, the year flashes on the display. Refer to sub-section 2.2 to set the date and time manually.

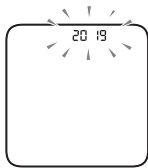

Note



- When the “” symbol flashes on the display, it is recommended you replace batteries.
- To replace batteries, turn your monitor off and remove all batteries. Then replace with 4 new batteries at the same time.
- Replacing batteries will not delete previous readings.
- The supplied batteries may have a shorter life span than new batteries.
- Disposal of used batteries should be carried out in accordance with local regulations.

2.2 Setting the Date and Time

Note

- Set your monitor to the correct date and time before taking a measurement for the first time.
- As soon as batteries are correctly installed, the year flashes on the display of your monitor.

1. If nothing is displayed, press the  button to display the year. If the year is already displayed, skip this step.

2. Press the  or  button to adjust the year.

Press and hold the  button to quickly advance the years.

Press and hold the  button to quickly go backwards through the years.

3. Press the  button to confirm the year, then the month will flash. Repeat the same steps to adjust the month, day, hour, and minute.

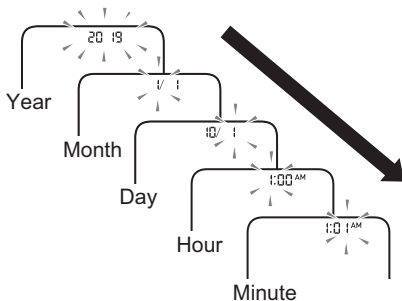

4. Press the  button to store the setting.

Your monitor automatically turns off 3 seconds after the minutes have been set in this sequence.

Note

- If you need to reset the date and time, replace batteries or press the  button, then set the date and time as shown in above steps.
- If the date and time are not set, “ - : - - ” flashes during or after measurement.

2.3 Blood Pressure Measurement Tips

To help ensure an accurate reading, follow these directions:

- Stress raises blood pressure. Avoid taking measurements during stressful times.
- Measurements should be taken in a quiet place.
- It is important to take measurements at the same times each day. Taking measurements in the morning and in the evening is recommended.
- Remember to have a record of your blood pressure and pulse readings for your physician. A single measurement does not provide an accurate indication of your true blood pressure. You need to take and record several readings over a period of time.

 Caution

- Avoid bathing, drinking alcohol or caffeine, smoking, exercising and eating for at least 30 minutes before taking a measurement.
 - Rest for at least 5 minutes before taking a measurement.
-

2.4 Applying the Arm Cuff

Note

- The following steps are for applying the arm cuff to your left arm. When you take a measurement on your right arm, follow the cuff wrap instructions for a right arm use mentioned under “To take a measurement on your right arm” located at the end of this sub-section.
- The blood pressure can differ between the right arm and the left arm, and the measured blood pressure readings can be different. OMRON recommends to always use the same arm for measurement. If the readings between both arms differ substantially, check with your physician to determine as to which arm to use for your measurements.

Caution

- Remove tight-fitting or thick clothing from your arm while taking a measurement.
-

1. Plug the arm cuff into your monitor by inserting the air plug into the air jack securely until it clicks.

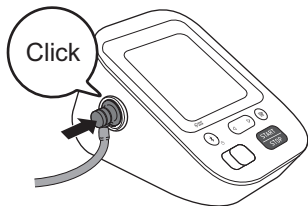

-
2. Place your hand through the cuff loop. Pull the cuff until it reaches your upper left arm.



Note

- The bottom edge of the arm cuff should be 0.5 inch (1 to 2 cm) above the inside elbow. The air tube is on the inside of your arm and aligned with your middle finger.

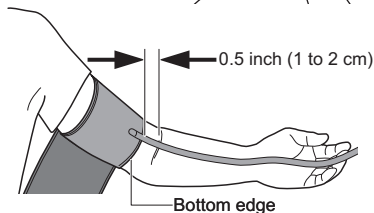

-
3. Make sure that the air tube is positioned on the inside of your arm and wrap the cuff securely, so it can not move around your arm.

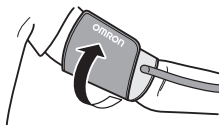

To take a measurement on your right arm

When you take a measurement on your right arm, the air tube should run along the side of your elbow, along the bottom of your arm. Be careful not to rest your arm on the air tube.



2.5 Sitting Correctly

To take a measurement, you need to be relaxed and comfortably seated in a room with a comfortable temperature. Place your arm on the table.

- Sit in a comfortable chair with your back and arm supported.
- Keep your feet flat and your legs uncrossed.
- The arm cuff should be placed on your arm at the same level as your heart, with the arm resting comfortably on a table.



2.6 Selecting a User ID

Your monitor is designed to take measurements and store the readings in the memory for 2 people using the [user ID selection] switch.

1. Select your user ID (1 or 2).

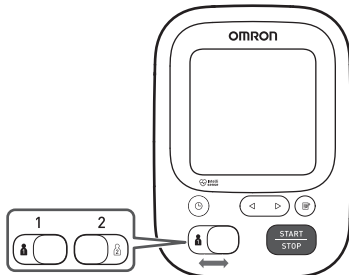

3. Using Your Monitor

3.1 Taking a Measurement

Note

- To stop the measurement, press the [START/STOP] button once to deflate the arm cuff.

⚠ Caution

- DO NOT use this monitor with other medical electrical (ME) equipment simultaneously. This may result in incorrect operation of the monitor and/or cause an inaccurate reading.
- Remain still and DO NOT talk while taking a measurement.

1. Press the [START/STOP] button.
All symbols appear on the display before starting the measurement.
2. Remain still and do not talk until the entire measurement process is complete.

The “” symbol flashes at every heartbeat.

After your monitor has detected your blood pressure and pulse rate, the cuff automatically deflates. Your blood pressure and pulse rate are displayed.

If either the systolic or the diastolic reading is high (refer to subsection 1.3), the “” symbol appears.

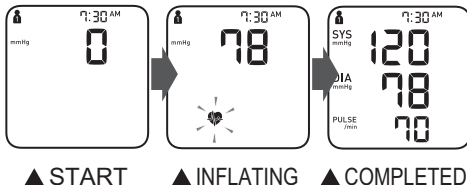

-
3. Press the [START/STOP] button to turn your monitor off.

Note

- Your monitor automatically turns off after 2 minutes.
- Wait 2 - 3 minutes between measurements. The wait time allows the arteries to decompress and return to their pre-measurement state. You may need to increase the wait time depending on your individual physiological characteristics.

■ Using the Guest Mode

The monitor stores measurement values for 2 users in the memory. The guest mode can be used to take a single measurement for another user.

Note

- No readings are stored in the memory.

-
1. Press and hold the [START/STOP] button for more than 2 seconds.

The user ID symbol and date/time display will disappear.



-
2. Release the [START/STOP] button when the user ID and date/time display turn off.

The arm cuff automatically starts to inflate.

■ If your systolic pressure is more than 210 mmHg

If your systolic pressure is more than 210 mmHg, take a measurement manually.

After the arm cuff starts to inflate, press and hold the [START/STOP] button until the monitor inflates 30 to 40 mmHg higher than your expected systolic pressure.

Note

- Do not inflate above 299 mmHg.

⚠ Caution

- Inflating to a higher pressure than necessary may result in bruising of the arm where the cuff is applied.
-

4. Using Memory Function

Your monitor automatically stores up to 60 readings per user.

Note

- This monitor can be used by multiple users. Refer to sub-section 2.6 to switch user. Make sure which user ID stores your own readings.

4.1 Viewing the Readings Stored in Memory

1. Select your user ID.
2. Press the  button.

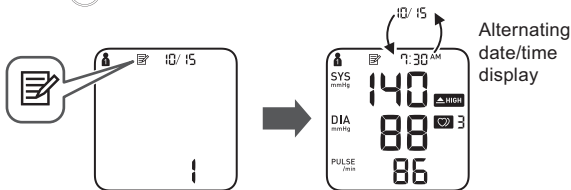

The Memory number appears for 1.5 seconds before the pulse rate is displayed. The most recent reading stored in the memory will be numbered as “1”.

Note

- If the reading is high (refer to sub-section 1.3), the “ HIGH” symbol appears.
- If there are no readings stored in the memory, the screen to the right is displayed.
- If the memory is full, new readings will replace the old readings, starting with the oldest reading.

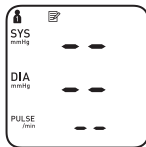

-
3. Press the ◀ or ▶ button repeatedly to scroll through the previous readings stored in the memory.

◀ : To view the older readings

▶ : To view the more recent readings

4.2 Viewing the Average Reading

Your monitor can calculate an average reading based on the latest 2 or 3 readings taken within the most recent 10 minute timeframe.

Note

- Set your monitor to the correct date and time before taking a measurement to view the average readings.

-
1. Select your user ID.
 2. When your monitor is off, press and hold the

 button for more than 2 seconds.

The “” symbol flashes.

Note

- If there are only 2 readings in the memory for that period, the average will be based on these 2 readings.
- If the average reading is high (refer to sub-section 1.3), the “” symbol appears.



5. Other Settings

5.1 Deleting All Readings Stored in Memory

1. Select your user ID.

2. Press the  button.

After a memory number appears, the latest reading will appear.

3. While holding the  button down, press and hold the [START/STOP] button for more than 3 seconds.
The display to the right flashes.

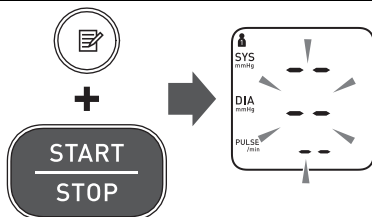

4. While holding the  button down again, press and hold the [START/STOP] button for more than 3 seconds.
The display stops flashing, then all readings are deleted.

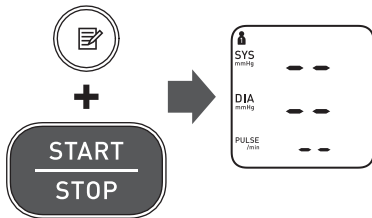

5. Press the [START/STOP] button to turn your monitor off.

Note

- All readings will be deleted. You cannot partially delete the readings stored in the memory.
- Your monitor will automatically turn off after 2 minutes.

5.2 Restoring Your Monitor to the Default Settings

To delete all the information stored in your monitor, follow the instructions below. Make sure that your monitor is turned off.

1. While holding the  button down, press and hold the [START/STOP] button for more than 3 seconds.

The display to the right flashes.

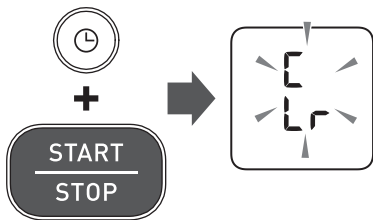

2. While holding the  button down again, press and hold the [START/STOP] button for more than 3 seconds.

The display stops flashing, then your monitor is restored to the default settings.

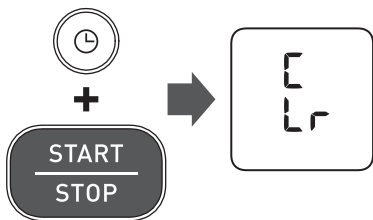







3. Press the [START/STOP] button to turn your monitor off.

6. Error Messages and Troubleshooting

If any of the below problems occur during measurement, check to make sure that no other electrical device is within 12 inches (30 cm). If the problem persists, refer to the table below.

| Display/Problem | Possible Cause | Solution |
|---|--|--|
| E 1 appears or the arm cuff does not inflate. | The [START/STOP] button was pressed while the arm cuff is not applied. | Press the [START/STOP] button again to turn the monitor off. After inserting the air plug securely and applying the arm cuff correctly, press the [START/STOP] button. |
| | Air plug is not completely plugged into the monitor. | Insert the air plug securely. Refer to sub-section 2.4. |
| | The arm cuff is not applied correctly. | Apply the arm cuff correctly, then take another measurement. Refer to sub-section 2.4. |
| | Air is leaking from the arm cuff. | Replace the arm cuff with a new one. Refer to section 8. |

| Display/Problem | Possible Cause | Solution |
|---|--|--|
| <p data-bbox="135 393 218 458">E2</p> <p data-bbox="45 462 306 615">appears or a measurement cannot be complete after the arm cuff inflates.</p> | <p data-bbox="325 260 645 387">You move or talk during a measurement and the arm cuff does not inflate sufficiently.</p> | <p data-bbox="665 165 990 485">Remain still and do not talk during a measurement. If “E2” appears repeatedly, inflate the arm cuff manually until the systolic pressure is 30 to 40 mmHg above your previous readings. Refer to sub-section 3.1.</p> |
| | <p data-bbox="325 516 638 579">The systolic pressure is above 210 mmHg</p> <p data-bbox="325 776 601 840">and a measurement cannot be taken.</p> | <p data-bbox="665 583 990 771">Inflate the arm cuff manually until the systolic pressure is 30 to 40 mmHg above your previous readings. Refer to sub-section 3.1.</p> |
| <p data-bbox="135 932 218 997">E3</p> <p data-bbox="122 1001 232 1032">appears</p> | <p data-bbox="325 935 648 1029">The arm cuff is inflated exceeding the maximum allowable pressure.</p> | <p data-bbox="665 868 990 1089">Do not touch the arm cuff and/or bend the air tube while taking a measurement. If inflating the arm cuff manually, refer to the end of sub-section 3.1.</p> |

| Display/Problem | Possible Cause | Solution |
|--|---|--|
|  appears | You move or talk during a measurement. Vibrations disrupt a measurement. | Remain still and do not talk during a measurement. |
|  appears | The pulse rate is not detected correctly. | Apply the arm cuff correctly, then take another measurement. Refer to sub-section 2.4. Remain still and sit correctly during a measurement. If the “  ” symbol continues to appear, we recommend you to consult with your physician. |
|  appears | | |
|  does not flash during a measurement | | |
|  appears | The monitor has malfunctioned. | Press the [START/ STOP] button again. If “Er” still appears, contact customer service. Refer to section 11. |
|  flashes | Batteries are low. | Replacing all 4 batteries with new ones is recommended. Refer to sub-section 2.1. |

| Display/Problem | Possible Cause | Solution |
|--|--|--|
|  appears or the monitor is turned off unexpectedly during a measurement. | Batteries are depleted. | Immediately replace all 4 batteries with new ones. Refer to sub-section 2.1. |
| Nothing appears on the display of the monitor. | Batteries are depleted. | Check the battery installation for proper placement. Refer to sub-section 2.1. |
| | Battery polarities are not properly aligned. | |
| Readings appear too high or too low. | Blood pressure varies constantly. Many factors including stress, time of day, and/or how you apply the arm cuff, may affect your blood pressure. Review sub-sections 2.3 - 2.5 and section 3. | |
| Any other problems occur. | Press the [START/STOP] button to turn the monitor off, then press it again to take a measurement. If the problem continues, remove all batteries and wait for 30 seconds. Then re-install batteries. If the problem still persists, contact customer service. Refer to section 11. | |

7. Maintenance

7.1 Maintenance

To protect your monitor from damage, follow the directions below:

- Changes or modifications not approved by the manufacturer will void the user warranty.

Caution

- DO NOT disassemble or attempt to repair this monitor or other components. This may cause an inaccurate reading.
-

7.2 Storage

Store your monitor and other components in a clean, safe location.

1. Remove the arm cuff from the monitor.
-

Caution

- To unplug the air plug, pull on the plastic air plug at the base of the tube, not the tube itself.
-

-
2. Gently fold the air tube into the arm cuff.

Note

- Do not bend or crease the air tube excessively.

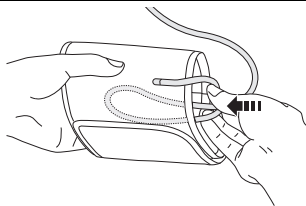

Do not store your monitor and other components:

- If your monitor and other components are wet.
- In locations exposed to extreme temperatures, humidity, direct sunlight, dust or corrosive vapors such as bleach.
- In locations exposed to vibrations or shocks.

7.3 Cleaning

- Do not use any abrasive or volatile cleaners.
- Use a soft dry cloth or a soft cloth moistened with mild (neutral) detergent to clean your monitor and arm cuff and then wipe them with a dry cloth.
- Do not wash or immerse your monitor and arm cuff or other components in water.
- Do not use gasoline, thinners or similar solvents to clean your monitor and arm cuff or other components.

7.4 Disposal

Dispose of your monitor, other components and optional accessories according to applicable local regulations.

Unlawful disposal may cause environmental pollution.

8. Optional Accessories

Small D-Ring Cuff

Arm circumference
7" - 9" (17 - 22 cm)



Model:

HEM-CS24-B REF HEM-CS24-BZ

Wide-Range D-Ring Cuff

Arm circumference
9" - 17" (22 - 42 cm)



Model:

HEM-RML31-B REF HEM-RML31-BZ

- Same as the arm cuff provided with the product.

Note

- Do not throw the air plug away. The air plug can be applicable to the optional cuff.

AC Adapter

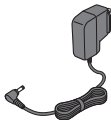

Model: HEM-ADPTW5

For further information, visit our website at OmronHealthcare.com

Using the AC Adapter (optional accessory)

Note

- Make sure not to place your monitor in a location where it is difficult to plug and unplug the AC adapter.
- We recommend keeping batteries in your monitor at all times, even if you choose to use the AC adapter. If only the AC adapter is used without keeping batteries in your monitor, you may need to reset the date and time each time you unplug and plug back the AC adapter. The readings will not be deleted.

1. Insert the AC adapter plug into the AC adapter jack on the rear side of your monitor.

2. Plug the AC adapter into an electrical outlet.

To unplug the AC adapter, unplug the AC adapter from the electrical

outlet and then remove the AC adapter plug from the monitor.

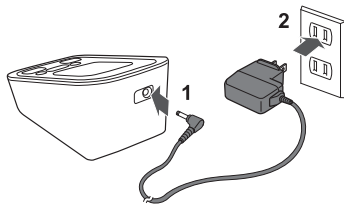

⚠ Caution

- ONLY use the AC adapter, arm cuff, batteries and accessories specified for this monitor. Use of unsupported AC adapters, arm cuffs and batteries may damage and/or may be hazardous to this monitor.

9. Specifications



| | |
|----------------------------------|---|
| Model | BP7200 <small>REF</small> HEM-7150-Z |
| Display | LCD digital display |
| Cuff pressure range | 0 to 299 mmHg |
| Blood pressure measurement range | SYS: 60 to 260 mmHg DIA: 40 to 215 mmHg |
| Pulse measurement range | 40 to 180 beats / min. |
| Accuracy | Pressure: ± 3 mmHg Pulse: ± 5 % of display reading |
| Inflation | Automatic by electric pump |
| Deflation | Automatic pressure release valve |
| Measurement method | Oscillometric method |
| Operation mode | Continuous operation |
| IP classification | Monitor: IP20 Optional AC adapter: IP21 |
| Rating | DC6 V 4.0 W |
| Power source | 4 "AA" batteries 1.5 V or optional AC adapter (INPUT AC100 - 240 V 50 - 60 Hz 0.12 - 0.065 A) |
| Battery life | Approximately 1000 measurements (using new alkaline batteries) |
| Durable period (Service life) | Monitor: 5 years Arm cuff: 5 years Optional AC adapter: 5 years |
| Operating conditions | +50 °F to +104 °F (+10 °C to +40 °C) / 15 to 90 % RH (non-condensing) / 800 to 1060 hPa |

| | |
|--|--|
| Storage / Transport conditions | -4 °F to +140 °F (-20 °C to +60 °C) / 10 to 90 % RH (non-condensing) |
| Weight | Monitor: Approximately 10.9 oz. (310 g) not including batteries Arm cuff: Approximately 6 oz. (170 g) |
| Dimensions | Monitor: Approximately 4.2" (w) × 3.4" (h) × 6.0" (l) (105 mm × 87 mm × 153 mm) Arm cuff: Approximately 5.7" × 23.4" (air tube: 29.5") (145 mm × 594 mm (air tube: 750 mm)) |
| Cuff circumference applicable to the monitor | 7" to 17" (17 to 42 cm) (included arm cuff: 9" to 17" (220 to 420 mm)) |
| Memory | Stores up to 60 readings per user |
| Contents | Monitor, Wide-Range D-Ring Cuff, 4 "AA" batteries, instruction manual, quick start guide |
| Protection against electric shock | Internally powered ME equipment (When using only batteries) Class II ME equipment (Optional AC adapter) |
| Applied part | Type BF (arm cuff) |

Note

- These specifications are subject to change without notice.
- This monitor complies with the requirements of ISO 81060-2:2013. In the clinical validation study, K5 was used on 85 subjects for determination of diastolic blood pressure.
- This monitor has not been validated for use on pregnant patients.
- IP classification is degrees of protection provided by enclosures in accordance with IEC 60529. This monitor and optional AC adapter are protected against solid foreign objects of 0.5 inch (12.5 mm) diameter and greater such as a finger. The optional AC adapter is protected against vertically falling water drops which may cause issues during a normal operation.

Pictogram on the Product

| | |
|---|---|
|  <p>● or ○ ART.</p> | Types of marks used to indicate the correct positioning of the artery for the upper arm |
|  | Identifies the type of cuff that is compatible with the blood pressure monitor |

10. FCC Statement

FCC CAUTION

Changes or modifications not expressly approved by the party responsible for compliance could void the user's authority to operate the equipment.

This device complies with part 15 of the FCC Rules. Operation is subject to the following two conditions: (1) This device may not cause harmful interference, and (2) this device must accept any interference received, including interference that may cause undesired operation.

Note

- This equipment has been tested and found to comply with the limits for a Class B digital device, pursuant to part 15 of the FCC Rules. These limits are designed to provide reasonable protection against harmful interference in a residential installation. This equipment generates, uses and can radiate radio frequency energy and, if not installed and used in accordance with the instructions, may cause harmful interference to radio communications. However, there is no guarantee that interference will not occur in a particular installation. If this equipment does cause harmful interference to radio or television reception, which can be determined by turning the equipment off and on, the user is encouraged to try to correct the interference by one or more of the following measures:
 - Reorient or relocate the receiving antenna.
 - Increase the separation between the equipment and receiver.
 - Connect the equipment into an outlet on a circuit different from that to which the receiver is connected.
 - Consult the dealer or an experienced radio/TV technician for help.

11. Limited Warranty

Your BP7200 Blood Pressure Monitor, excluding the arm cuff and batteries is warranted to be free from defects in materials and workmanship appearing within 2 years from the date of purchase, when used in accordance with the instructions provided with the monitor. The arm cuff is warranted to be free from defects in materials and workmanship appearing within 1 year from the date of purchase when the monitor is used in accordance with the instructions provided with the monitor. The above warranty extends only to the original retail purchaser, and only to products purchased from an Omron authorized seller who is subject to and follows Omron's quality control standards, unless otherwise prohibited by law. We will, at our option, replace without charge any monitor or arm cuff covered by the above warranty. Replacement is our only responsibility and your only remedy under the above warranty.

To obtain warranty service contact Customer Service by calling **1-800-634-4350** for the address of the inspection center and the return shipping and handling fee that may apply.

Enclose the original printed receipt. Include a letter, with your name, address, phone number, and description of the specific problem. Pack the product carefully to prevent damage in transit. Because of possible loss in transit, we recommend insuring the product with return receipt requested.

THE FOREGOING IS THE SOLE WARRANTY PROVIDED BY OMRON IN CONNECTION WITH THIS PRODUCT, AND OMRON HEREBY DISCLAIMS ANY OTHER WARRANTIES, EXPRESS OR IMPLIED, INCLUDING IMPLIED WARRANTIES OF MERCHANTABILITY AND FITNESS FOR A PARTICULAR PURPOSE. IMPLIED WARRANTIES AND OTHER TERMS THAT MAY BE IMPOSED BY LAW, IF ANY, ARE LIMITED IN DURATION TO THE PERIOD OF THE ABOVE EXPRESS WARRANTY.

SOME STATES DO NOT ALLOW LIMITATIONS ON HOW LONG AN IMPLIED WARRANTY LASTS, SO THE ABOVE LIMITATION MAY NOT APPLY TO YOU.

OMRON SHALL NOT BE LIABLE FOR LOSS OF USE OR ANY OTHER SPECIAL, INCIDENTAL, CONSEQUENTIAL OR INDIRECT COSTS, EXPENSES OR DAMAGES.

SOME STATES DO NOT ALLOW THE EXCLUSION OR LIMITATION OF INCIDENTAL OR CONSEQUENTIAL DAMAGES, SO THE ABOVE LIMITATION OR EXCLUSION MAY NOT APPLY TO YOU.

This warranty provides you with specific legal rights, and you may have other rights that vary by jurisdiction. Because of special local requirements, some of the above limitations and exclusions may not apply to you.

FOR CUSTOMER SERVICE

Visit our web site at:

OmronHealthcare.com

Call toll free:

1-800-634-4350

12. Guidance and Manufacturer's Declaration

OMRON Battery-operated / AC Adapter-operated Blood Pressure Monitor
Information for Accompanying Documents in the Scope of
IEC60601-1-2:2014

Important information regarding Electromagnetic Compatibility (EMC)

BP7200 conforms to IEC60601-1-2:2014 Electromagnetic Compatibility (EMC) standard.

Further documentation in accordance with this EMC standard is available at OmronHealthcare.com/emc. Refer to the EMC information for BP7200 on the website.



OMRON HEALTHCARE Co., Ltd
53, Kunotsubo, Terado-cho, Muko, Kyoto, 617-0002 JAPAN

Distributed by:
OMRON HEALTHCARE, INC.
1925 West Field Court, Lake Forest, IL 60045 U.S.A.

OmronHealthcare.com
© 2019 OMRON HEALTHCARE, INC.

Made in Vietnam

3608857-01