

Karaoke USA

CD+G KARAOKE

COMPACT
disc
DIGITAL AUDIO
GRAPHICS

COMPACT
disc
DIGITAL AUDIO

User's Guide

MODEL:
GQ740



Smart Device
Not Included.

Before operating this product, please read these instructions.

Warnings and Precautions

CAUTION: TO PREVENT ELECTRIC SHOCK, MATCH WIDE BLADE OF PLUG TO WIDE SLOT, FULLY INSERT.

WARNING: To reduce the risk of fire or electric shock, do not expose this apparatus to rain or moisture.

AVERTISSEMENT: Pour réduire le risque d'incendie ou de choc électrique, ne pas exposer cet appareil sous la pluie et l'humidité.

CAUTION: Use of controls or adjustments or performance of procedures other than those specified may result in hazardous radiation exposure.

WARNING: Changes or modifications to this unit not expressly approved by the party responsible for compliance could void the user's authority to operate the equipment.

WARNING: Do not place the unit on top of any soft, porous, or sensitive surfaces to avoid damaging the surface. Use a protective barrier between the unit and surface to protect the surface.

WARNING: Changes or modifications to this unit not expressly approved by the party responsible for compliance could void the user's authority to operate the equipment.

WARNING: Do not place the unit on top of any soft, porous, or sensitive surfaces to avoid damaging the surface. Use a protective barrier between the unit and surface to protect the surface.

WARNING: Use of this unit near fluorescent lighting may cause interference regarding use of the remote. If the unit is displaying erratic behavior move away from any fluorescent lighting, as it may be the cause.

CAUTION: Danger of explosion if battery is incorrectly replaced. Replace only with the same or equivalent type.

PRÉCAUTION: Danger d'explosion si les piles sont remplacées de façon incorrecte. Remplacer les piles seulement par le même type de pile ou l'équivalent.

WARNING: There is a danger of explosion if you attempt to charge standard Alkaline batteries in the unit. Only use rechargeable NiMH batteries.

WARNING: The remote control's button cell battery contains mercury. Do not put in the trash, instead recycle or dispose of as hazardous waste.

WARNING: Lithium batteries, like all rechargeable batteries are recyclable and should be recycled or disposed of in normal household waste. Contact your local government for disposal or recycling practices in your area. They should never be incinerated since they might explode.

WARNING: Shock hazard - Do Not Open.
AVIC: RISQUE DE CHOC ÉLECTRIQUE - NE PAS OUVRIR

Mains plug is used as disconnect device and it should remain readily operable during intended use. In order to disconnect the apparatus from the mains completely, the mains plug should be disconnected from the mains socket outlet completely.

La prise du secteur est utilisé pour déconnecter le système.

La prise du secteur ne doit pas être obstruée ou doit être facilement accessible pendant son utilisation.

Pour être complètement déconnecté de l'alimentation d'entrée, la prise doit être débranchée du secteur.

CAUTION

RISK OF ELECTRIC SHOCK
DO NOT OPEN

WARNING: TO REDUCE THE RISK OF ELECTRIC SHOCK, DO NOT REMOVE COVER (OR BACK). NO USER-SERVICEABLE PARTS INSIDE. REFER SERVICING TO QUALIFIED SERVICE PERSONNEL.

ATTENTION

RISQUE D'ÉLECTROCUTION
NE PAS OUVRIR



The lightning flash with arrowhead symbol, within an equilateral triangle, is intended to alert the user to the presence of uninsulated "dangerous voltage" within the product's enclosure that may be of sufficient magnitude to constitute a risk of electric shock to persons.



The exclamation point within an equilateral triangle is intended to alert the user to the presence of important operating and maintenance (servicing) instructions in the literature accompanying the appliance.



This product utilizes a Class 1 laser to read Compact Discs. This laser Compact Disc Player is equipped with safety switches to avoid exposure when the CD door is open and the safety interlocks are defeated. Invisible laser radiation is present when the CD Player's lid is open and the system's interlock has failed or been defeated. It is very important that you avoid direct exposure to the laser beam at all times. Please do not attempt to defeat or bypass the safety switches.

Important Safety Instructions

1. Read these Instructions.
2. Keep these Instructions.
3. Heed all Warnings.
4. Follow all instructions.
5. Do not use this apparatus near water
6. Clean only with a dry cloth.
7. Do not block any ventilation openings. Install in accordance with the manufacturer's instructions.
8. Do not install near any heat sources such as radiators, heat registers, stoves, or other apparatus (including amplifiers) that produce heat.
9. Do not defeat the safety purpose of the polarized or grounding - type plug. A polarized plug has two blades with one wider than the other. A grounding type plug has two blades and a third grounding prong. The wide blade or the third prong are provided for your safety. When the provided plug does not fit into your outlet, consult an electrician for replacement of the obsolete outlet.
10. Protect the power cord from being walked on or pinched particularly at plugs, convenience receptacles, and the point where they exit from the apparatus.
11. Only use attachments/accessories specified by the manufacturer.
12.  Use only with a cart, stand, tripod, bracket, or table specified by the manufacturer, or sold with the apparatus. When a cart is used, use caution when moving the cart/apparatus combination to avoid injury from tip-over.
13. Unplug this apparatus during lightning storms or when unused for long periods of time.
14. Refer all servicing to qualified service personnel. Servicing is required when the apparatus has been damaged in any way, such as power-supply cord or plug is damaged, liquid has been spilled or objects have fallen into the apparatus, the apparatus has been exposed to rain or moisture, does not operate normally, or has been dropped.

FCC Warnings

NOTE: This equipment has been tested and found to comply or has been dropped with the limits for a Class B digital device, pursuant to Part 15 of the FCC Rules. These limits are designed to provide reasonable protection against harmful interference in a residential installation. This equipment generates, uses, and can radiate radio frequency energy and, if not installed and used in accordance with the instructions, may cause harmful interference to radio communications. However, there is no guarantee that interference will not occur in a particular installation. If this equipment does cause harmful interference to radio or television reception, which can be determined by turning the equipment off and on, the user is encouraged to try to correct the interference by one or more of the following measures:

- Reorient or relocate the receiving antenna.
- Increase the separation between the equipment and receiver.
- Connect the equipment into an outlet on a circuit different from that to which the receiver is connected.
- Consult the dealer or an experienced radio/TV technician for help.

Additional Warnings

- The apparatus shall not be exposed to dripping or splashing and that no objects filled with liquids, such as vases, shall be placed on apparatus.
L'appareil ne doit pas être exposé aux écoulements ou aux éclaboussures et aucun objet ne contenant de liquide, tel qu'un vase, ne doit être placé sur l'objet.
- Main plug is used as disconnect device and it should remain readily operable during intended use. In order to disconnect the apparatus from the mains completely, the mains plug should be disconnected from the mains socket outlet completely.
La prise du secteur ne doit pas être obstruée ou doit être facilement accessible pendant son utilisation. Pour être complètement déconnecté de l'alimentation d'entrée, la prise doit être débranchée du secteur.
- Battery shall not be exposed to excessive heat such as sunshine, fire or the like.
Les piles ne doivent pas être exposées à de forte chaleur, tel qu'à la lumière du soleil, au feu ou autres choses de semblable.
- Caution marking is located at the rear or back of the apparatus.
Attention marquage est situé à l'arrière ou à l'arrière de l'appareil.
- The marking information is located at the rear or back of apparatus.
Les informations de marquage est situé à l'arrière ou à l'arrière de l'appareil.

Contents

Warnings and Precautions	1
Important Safety Instructions	2
Contents	3
Feature / Included	4
- Features	
- Included	
Introduction	5
Location Controls	6
Monitor Message	6
Setup Cradle	7
- Install Cradle into the Unit	
- Place External Device	
SetupPower	8
- Connect Power Adapter	
Connect Ext. Device & Sound From Main Unit Speaker	8
- AUX IN (LINE In / AUDIO In)	
Using CD+G, CDs	9
- Loading a CD	
- Playing a CD	
- Repeat Function	
- Programming a Disc up to 20 tracks	
Connecting to a Television/ DVD / Ext. Device	10
- Composite Video Output	
- RCA Audio Output	
Using Microphones	11
Using AVC and ECHO/ BALANCE	11
- AVC	
- ECHO	
- BALANCE	
Specification	12

Feature / Included

Feature

- CD player: CD+G, CD, CD-R/RW
- Mic Volume Controls
- Echo Control
- AVC Control
- Balance Control
- TFT display
- Microphone Jacks, 6.3mm x2
- RCA audio output
- Line in jack 3.5mm (Aux input / Audio input)
- Disco Lights
- Built-in speakers
- AC power: Requires AC power adapter

Included

- Karaoke System
- Microphone
- RCA Audio/Video cable
- AC power adapter
- User Manual & Warranty Card
- Audio cable
- CD+G Disc
- Universal cradle & insert

Omni-Directional Microphone

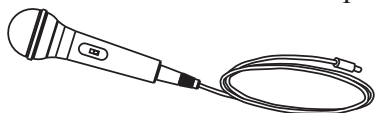

AC Adapter

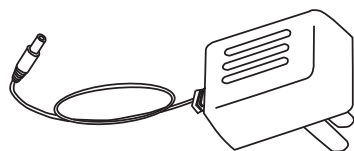

RCA Audio/Video cable



Audio cable



Karaoke Machine

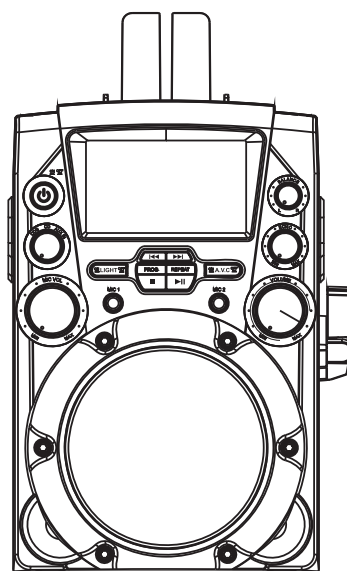

Universal Cradle

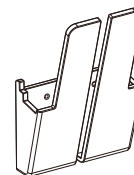

Cradle Insert

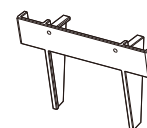

User Manual
& Warranty Card

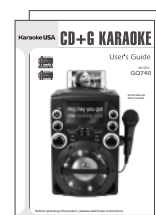

CD+G Disc

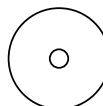

Introduction

FRONT VIEW

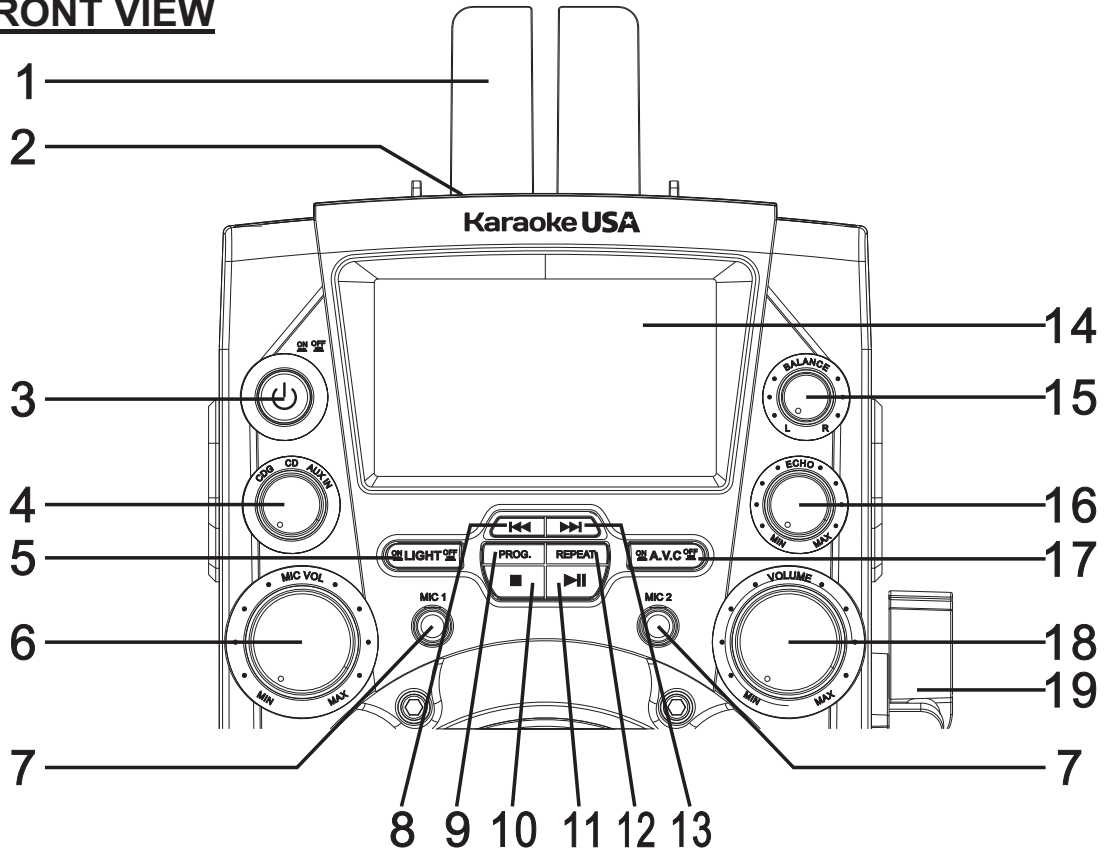

REAR VIEW

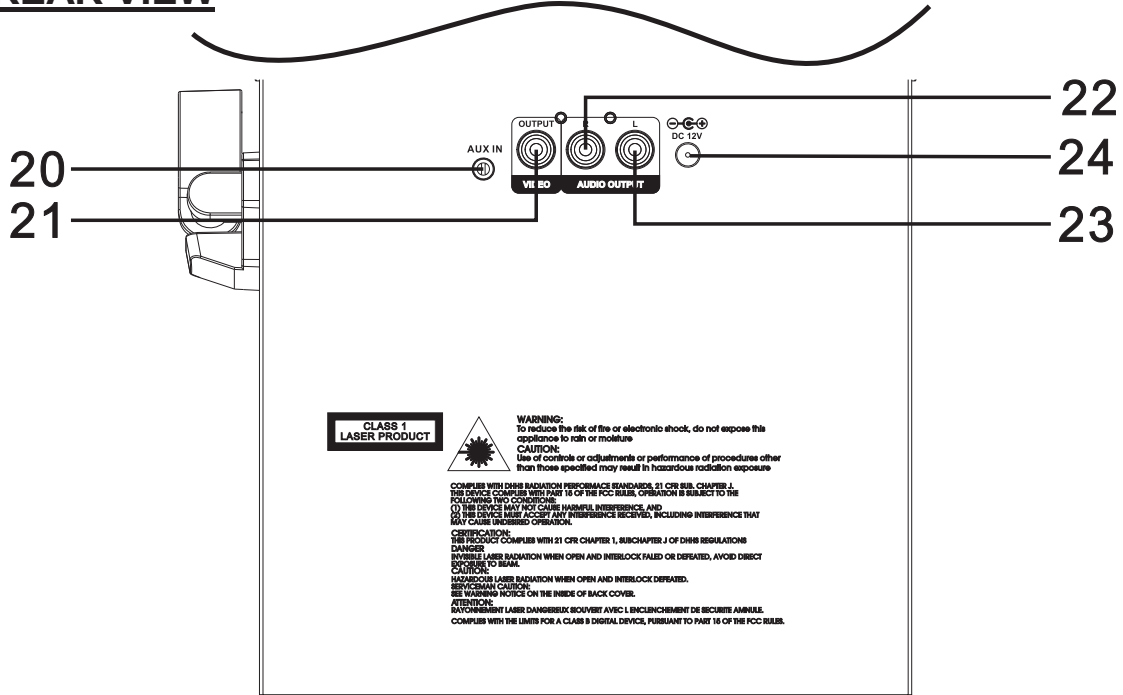

Location Controls

1. **DETACHABLE CRADLE:** Place your mobile / tablet on the cradle.
2. **CD Door :** Open the door to install disc.
3. **ON/OFF Button:** Press this button to turn on / off unit.
4. **FUNCTION:** Rotate to select CDG (DISC) mode / AUX IN mode.
5. **LIGHT Button:** Press this button to turn on / off Disco Lights
6. **MIC VOLUME Dial:** Rotate to adjust the volume from the MIC input.
7. **MIC Inputs :** Mic 1 and Mic 2 input jack
8. **SKIP/SEARCH(Back):** Press to skip previous tracks on loader disc. Press and hold to fast-rewind the current track on a loaded disc (not applied for CD+G disc).
9. **PROGRAM Button:** Press to program a loaded disc to play tracks in specified order.
10. **STOP Button :** Press to stop a disc playing
11. **PLAY / PAUSE Button:** Press to play or pause a loaded disc.
12. **REPEAT Button:** Press repeatedly to set the current track or entire disc to repeat
13. **SKIP/SEARCH(Forward):** Press to skip next tracks on loaded disc. Press and hold to fast-forward the current track on a loaded disc (not applied for CD+G disc).
14. **TFT DISPLAY:** Show disc tracks number & CDG graphic.
15. **BALANCE Dial:** Rotate the dial to select vocals or music only or a standard balance function.
16. **ECHO Dial:** Rotate to adjust echo sound effect.
17. **A.V.C Button:** Press to Auto Voice Control on / off.
18. **VOLUME Dial:** Rotate to adjust the main volume sound level.
19. **MIC Holder:** Place the microphone on the holder
20. **AUX IN (Line in / Audio in) :** Connect to external device audio output.
21. **VIDEO OUT Jack:** Connect to TV video input.
22. **AUDIO OUT R (Line out / Aux out) Jack:** Connect to external device audio input R.
23. **AUDIO OUT L (Line out / Aux out) Jack:** Connect to external device audio input L.
24. **DC INPUT Jack:** Connect power adapter for AC power.

Monitor Message

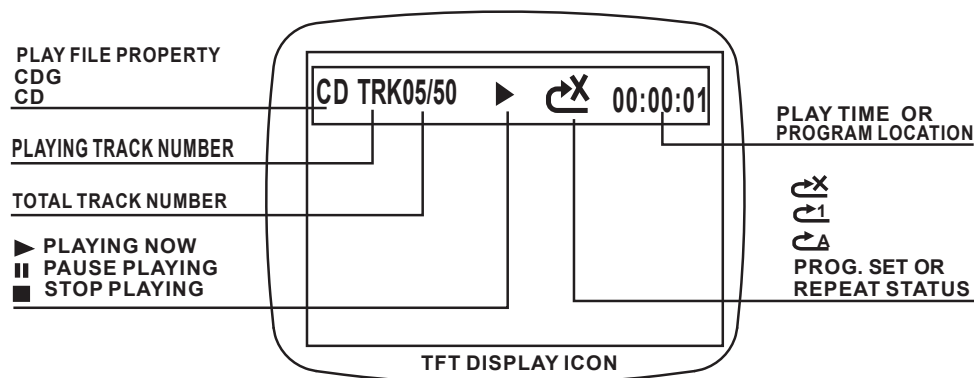

Setup Cradle

Install Cradle into the unit

Install the cradle (included) to hold the Mobile & Tablet onto unit.

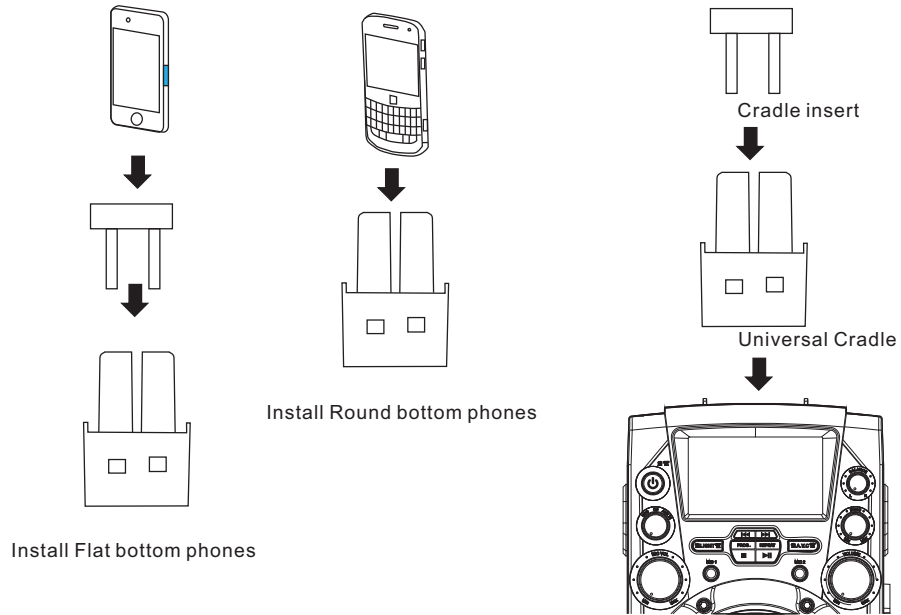

Place External Device

Insert Personal Player / Mobile Phone / Tablet with cradle onto the unit.

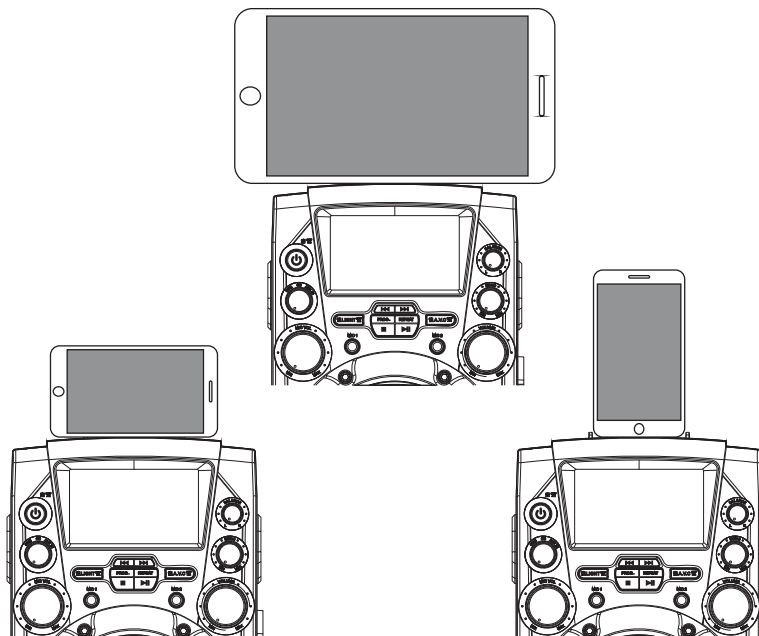

Setup Power

Connect Power Adapter

Plug the included AC adapter into the standard AC power outlet to power the **KARAOKE SYSTEM**. Connect small end to **DC INPUT** jack of main unit. After adapter connection, Press the **ON/OFF** button to turn on / off the **Karaoke System**.



Connect Ext. Device & Sound From Main Unit Speaker

AUX IN (LINE In / AUDIO In)

To connect a MP3 Player or other Audio Device you will need a 3.5mm Auxiliary Cable.

1. Connect a 3.5mm Auxiliary Cable to the **AUX IN** jack at the rear side of unit and to the Audio Output or Phones on the audio device you wish to play.
2. Rotate the **FUNCTION** selector of Karaoke System to **AUX IN** position.
3. Turn on both units and **AUX** indicator will light.
4. After the connection, the external device will sound from speakers of your unit.

Please note:-If not use the this function, please unplug it.

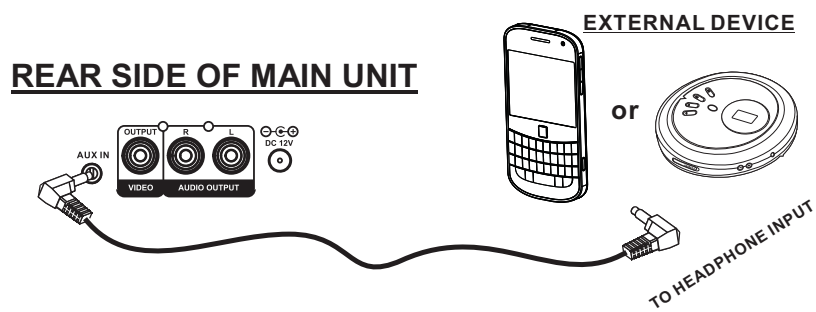

Using CD+G, CDs

Loading a Disc

1. Connect power (follow **SETUP POWER** page) .
2. Pull the **CD DOOR OPEN AREA** to open the **CD DOOR**.
3. Place a **CD+G** or **CD** into the **CD** compartment.
4. Close the **CD DOOR**. Press the **POWER** button to turn on unit.
5. Rotate **FUNCTION** selector to CDG (DISC) position.

Playing a Disc

1. Follow the instructions for **Loading a Disc**.
2. Press the **PLAY/PAUSE** button to begin playing the loaded disc.
3. Rotate the **MASTER VOLUME** dial to select the sound level.
4. To temporarily stop playing, press the **PLAY/PAUSE** button once.
To resume play, press the **PLAY/PAUSE** button one more.
5. Press **◀◀ / ▶▶** buttons to skip between next or previous tracks.
6. Hold the **◀◀ / ▶▶** buttons to fast search through the track.
Please note:-The fast-forward / fast-rewind functions will not work for CDG discs.
7. Connect the **VIDEO OUT** jack to TV, the lyrics text will show on TV.
8. Press the **STOP** button to stop playing.

Repeat Function

1. Follow the instructions for **Loading a Disc and Playing a Disc**.
2. Press the **REPEAT** button once and **↺1** indicator light. The unit will play the current track repeatedly.
3. Press the **REPEAT** button twice and **↺A** indicator light. The unit will play the entire disc repeatedly.
4. To cancel the repeat function: press the **REPEAT** button repeatedly the **↺X** indicator light or press the **STOP** button twice to stop.



Programming a Disc up to 20 tracks

1. When disc playing, press the **STOP** button to stop mode.
2. Press the **PROGRAM** button and the program (PROG. SET) (see on the top right screen).
3. Press the **◀◀ / ▶▶** buttons to select the track from the loaded disc you wish to play first.
4. Press the **PROGRAM** button to confirm.
5. Repeat steps 3 and 4 to select more tracks.
6. Press the **PLAY** button to start the program playing.
7. Press the **STOP** button twice to cancel a program.

Connecting to a Television / DVD / Ext. Device

Composite Video output

Require an **RCA** video cable.

1. Plug the included RCA audio/video cable into the **VIDEO OUT** and a composite video input on a television.
2. Adjust the television to the correct input setting.
3. When playing **CDG** discs, the **Karaoke System** will output written lyrics to the connected television

RCA Audio Output

Requires an **RCA** audio cable.

1. Plug the included RCA audio/video cable into the **AUDIO OUT** and a **RCA** audio input on a television or stereo system.
2. Adjust the television or stereo system to the correct input setting.
3. When playing the disc, the **Karaoke System** will output audio to the connected television or stereo system. Use the external device to control the output sound level.

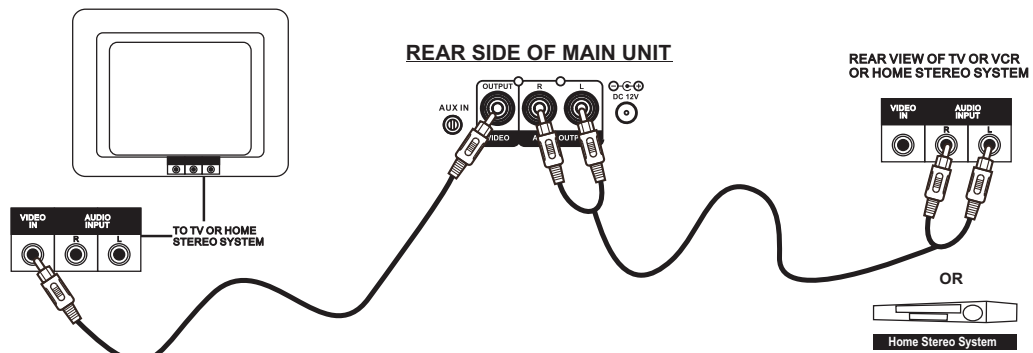

Using Microphone

Requires a microphone (included one)

1. Plug the microphone (see below figure) into the **MIC 1 INPUT** or **MIC 2 INPUT**.
2. Slide the **ON /OFF** switch of **MICROPHONE**,
3. Use the **MIC VOLUME** dial of **Karaoke System** to adjust the volume of audio sound from the microphone.

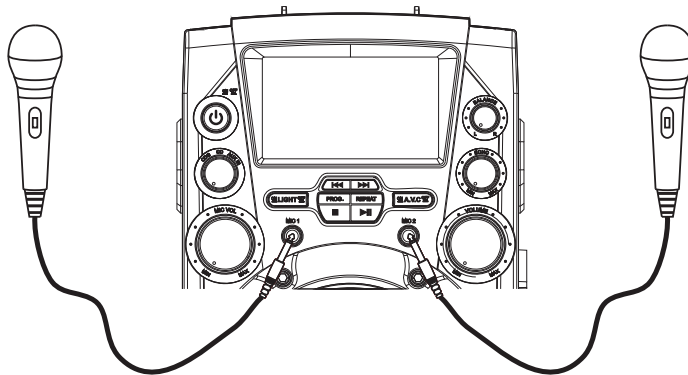

Using AVC / ECHO / BALANCE

AVC

The **AVC** (Automatic Voice Control) can be activated by the A.V.C button. The vocals on the multiplex recording will be muted when the singer starts to sing through the microphone. When the singer stops singing the vocals will resume to normal.

ECHO



Adjust the **ECHO** dial of **Karaoke System** to enhance your voice for a concert hall effect.

BALANCE

Rotate the **BALANCE** dial of **Karaoke System** to hear the music and vocals or to hear the music only.

Notes: To use the **BALANCE** dial, a CD+G disc must be used. Otherwise it will operate as a standard **BALANCE** control.

Specification

AC Power Adapter Connect DC Jack	Use included adapter AC~ Input 120 / 60 Hz , DC Output 5V , 1. 8A
CD Player	Support CDs and CDG disc 4.75 / 3.25 inch  
Master Power Output	4.5W x 1 RMS
Loud Speakers Spec	3.5 Inch,8 Watt , 2 Ohm

Specifications are typical, individual units might vary. They are subject to continuous improvement without notice and without incurring any obligation.

KARAOKE USA

1185 Gooden Crossing, Largo,

Florida, 33778, USA

www.KaraokeUSA.com

1-800-568-2000 ■ 727-209-1313

printed in china