



# 150" Home Theater 720P LCD Projector with Built-in DVD Player

NVP-2500



## User Manual

Please read carefully before using product and  
keep for future reference

# Table of Contents

Introduction.....	3
Safety Instructions.....	4
Additional Warnings.....	5
Package Contents.....	6
Basic Information.....	7
Placing Projector.....	8
Making Adjustments.....	9
Remote Overview.....	10
Remote Batteries.....	12
Projector Overview.....	13
Main Operation.....	14
Bluetooth Operation.....	15
HDMI Operation.....	17
Audio / Video Input.....	18
Computer Video (VGA).....	19
External Audio.....	20
Micro SD & USB Inputs.....	21
DVD Playback.....	22
Specifications.....	23
Support.....	24

# Introduction

Congratulations, and thank you for choosing Naxa's 150" Home Theater 720P LCD Projector with Built-in DVD Player. This manual will help you operate your new device.

We know you have many choices when it comes to technology; thank you for choosing us here at Naxa Electronics. Established in 2001 in Los Angeles, California, we are dedicated to delivering products that entertain and delight.

We trust that you will be happy with your purchase. Please read this manual carefully and save it for reference. You may also find the latest FAQ, documentation, and other product material at our website. Come visit us on the web at [www.naxa.com](http://www.naxa.com) and see all that we have to offer!

# Safety Instructions

1. Read these instructions.
2. Keep these instructions.
3. Heed all warnings.
4. Follow all instructions.
5. Do not use this apparatus near water.
6. Clean only with a dry cloth.
7. Do not block any ventilation openings. Install in accordance with the manufacturer's instructions.
8. Do not install near any heat sources, such as radiators, heat registers, stoves, or other apparatus (including amplifier) that produce heat.
9. Protect the power cord from being walked on or pinched, particularly at plugs, convenience receptacles, and the point where they exit from the apparatus.
10. Only use attachments / accessories specified by the manufacturer.
11. Unplug this apparatus during lightning storms or when unused for long periods of time.
12. Refer all servicing to qualified service personnel. Servicing is required when the apparatus has been damaged in any way, such as power-supply cord or plug is damaged, liquid has been spilled or objects have fallen into the apparatus, the apparatus has been exposed to rain or moisture, does not operate normally, or has been dropped.
13. Use only with a cart, stand, tripod, bracket, or table specified by the manufacturer or sold with the apparatus. When a cart is used, use caution when moving the cart / apparatus combination to avoid injury from tip-over.

## Additional Warnings

1. Do not look directly into the projector light.
2. Do not touch the projector lens.
3. Mains adapter is used as disconnect and it should remain readily operable during intended use. In order to disconnect the apparatus from the mains completely, the mains plug should be disconnected from the mains socket completely.
4. **CAUTION:** Use of controls or adjustments or performance of procedures other than those specified may result in hazardous radiation exposure.
5. **WARNING:** Changes or modified to this unit not expressly approved by the party responsible for compliance could void the user's authority to operate the equipment.
6. **WARNING:** Use of this unit near fluorescent lighting may cause interference regarding use of the remote. If the unit is displaying erratic behavior move away from any fluorescent lighting, as it may be the cause.
7. **WARNING:** Shock hazard - DO NOT OPEN.
8. Caution and marking information is located at the rear or bottom of the apparatus.
9. **WARNING:** To reduce the risk of fire or electric shock, do not expose this apparatus to rain, moisture, dripping, or splashing.
10. Objects filled with liquids, such as vases, shall not be placed on the apparatus.

# Package Contents



Projector



AC Power Adapter

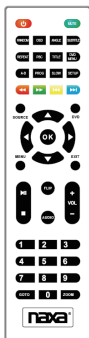

Remote control



User manual

## Basic Information

Your projector comes with a lens cap to protect the lens from dirt and debris when not in use. Be sure to remove the lens cap before using the projector, and reinstall the lens cap when done, as seen below.

Remove the lens cover before use



Close the lens cover when the unit is not in use

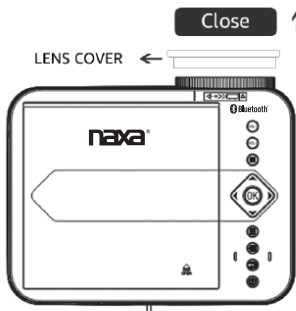

# Placing Projector

Your projector can be installed in four different configurations (see picture below).

## Front Table:

Select this location with the projector placed near the floor in front of the screen. This is the most common way to position the projector for quick setup and portability.



FRONT TABLE

## Front Ceiling:

Select this location with the projector suspended upside-down from the ceiling in front of the screen.

**NOTE:** A projector mount is required to install the projector on the ceiling.

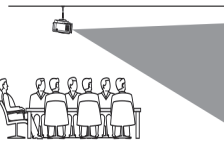

FRONT CEILING

## Rear Table:

Select this location with the projector placed near the floor behind screen.

**NOTE:** A special rear projection screen is required.

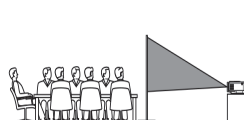

REAR TABLE

## Rear Ceiling:

Select this location with the projector suspended upside-down from the ceiling behind the screen.

**NOTE:** A projector mount and a special rear projection screen is required.

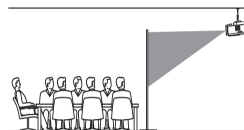

REAR CEILING



## Making Adjustments

Follow the pictures below to adjust the focus and trapezoidal screen. Adjust the focus by turning the knob while observing the image pixels near the center of the screen. Optimal focus is obtained when the pixels are clearly visible. Depending on the projected screen size, the focus near the screen edges may be less sharp than the screen center.

### FOCUS ADJ. STUD

Then sharpen the image by turning the focus knob.



Keystone image is created when the projector beam is projected to the screen in an angle. Keystone correction will restore the distorted image to a rectangular or square shape.

### TRAPEZOIDAL ADJ. KNOB

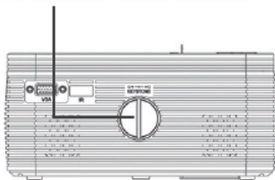

# Remote Overview

1. Power: Press to power on
2. Mute: Mute the audio playback. Press again to reactivate audio playback
3. Random: Press to play tracks at random from a loaded disc.
4. OSD: Press to display the information of the current video / audio.
5. Angle: On supported DVDs, press and hold to view alternate angles.
6. Subtitle: Briefly press to change subtitle mode.
7. Repeat: Press repeatedly to cycle through repeat options for a loaded disc.
8. PBC: Press to activate Play Back Control function, only for a VCD discs. Press again to turn off.
9. Title: Press to view the title menu of a loaded DVD.
10. DVD Menu: Press to view the main menu of a loaded DVD.
11. A-B: Press to create a repeating loop on a loaded DVD.
12. PROG: Program a loaded disc to play chapters and titles or tracks in a specific order.
13. Slow: During playback, press repeatedly to set the slow motion speed.
14. Setup: Press to access the setup menu only for DVD mode.

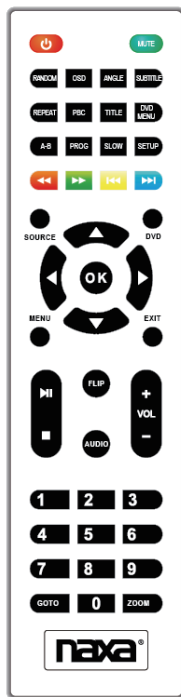

15. Previous / Next: Press to skip between chapters or tracks.
16. Rewind / Fwd: Press to search through an individual chapter or track.
17. Arrows / OK: Press to navigate and confirm selections in settings and other menus.
18. Source: Press to select media source (AV / HDMI 1 / HDMI 2A / GA / DVD / MEDIA PLAYER)
19. DVD: Press to enter the DVD player mode once in another source.
20. Menu: Press to access projector settings menu.
21. Exit: Press to exit the projector menu or the audio / movie playback.
22. Play / Pause: Press here to play or pause the audio / movie playback.
23. Stop: stop the audio / video / photo playback.
24. Flip: Press to rotate / mirror projector screen.
25. Audio: Press to switch the available audio channels provided by the disc.
26. VOL +: Raise the volume.
27. VOL -: Decrease the volume.
28. 0-9 Number Keypad: enter chapter / title to play.
29. Go To: Go to a specific chapter or track number. Use play button to begin playing.
30. Zoom: For the movie / video, press to access the zoom function. For photos, press to switch between 1000%, 125%, 150%, 200%, 75%, 50%, and normal status.

## Remote Batteries

Remove the battery cover on the back of the remote control by gently pushing it open. The battery cover can then be raised. Insert the correct batteries (not included) according to the polarity markings. Finally, replace the cover.

### NOTE:

- Batteries must not be exposed to excessive heat, such as sunshine / fire.
- Make sure that the batteries are installed correctly.
- Do not mix old and new batteries.
- Only use the same or equivalent batteries as recommended.
- Do not dispose of batteries in the fire, the battery could explode or leak. Do not try to charge a battery.

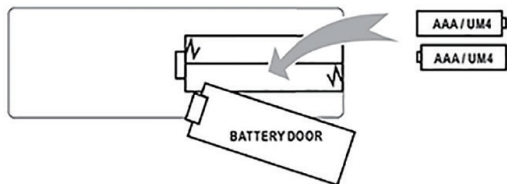

# Projector Overview

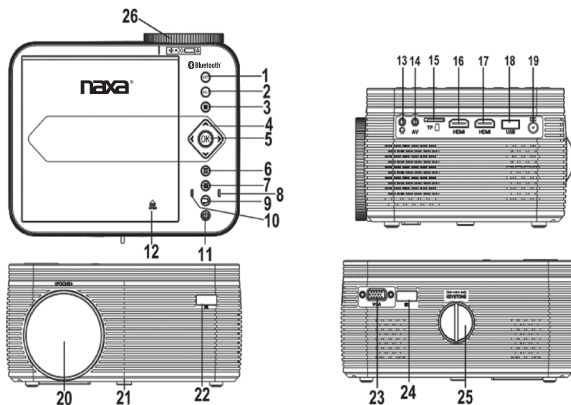

- |                        |                           |
|------------------------|---------------------------|
| 1.VOLUME+              | 14.AV jack                |
| 2.VOLUME-              | 15.Micro SD card          |
| 3.STOP                 | 16.HDMI port 1            |
| 4.NAVIGATOR Buttons    | 17.HDMI port 2            |
| 5.OK                   | 18.USB port(Media player) |
| 6.MENU button          | 19.DC IN jack             |
| 7.SOURCE button        | 20.LENS                   |
| 8.POWER ON Indicator   | 21 .ANGEL ADJ. Knob       |
| 9.RETURN button        | 22.1R Window(Front Side)  |
| 10.POWER OFF Indicator | 23.VGA Port               |
| 11.POWER Button        | 24.IRWindow(RearSide)     |
| 12.Open disc cover     | 25.TRAPEZOIDALADJ. Knob   |
| 13.EARPHONE jack       | 26.FOCUSADJ. Knob         |

# Main Operation

 - Press the button to turn on the unit and press it again to turn it off.

 / **SOURCE** - Press the button to select the input source.

 / **MENU** - Press the button to enter the projector menu.

 - Press the buttons to select the screen element of the projector menu.

 / **EXIT** - Press the button to exit the projector menu.

 - Press the buttons to fast forward and backward to USB / TF.

 - Press the buttons to search for the next or previous file on USB / TF.

**VOL+ / VOL-** - Press the buttons to select the correct sound.

 - Press the button to play / pause the connection USB / TF card.

**FLIP** - Press the button to rotate / mirror the projector screen.

**ZOOM** - Press the button to select the image scale.

 - Press to mute the sound of your projector. Press again to continue.

## Bluetooth® Operation

Pairing is the term used when two Bluetooth devices are connected wirelessly for the first time. This allows the devices to see each other and sets up a one-to-one communication channel between both devices.

### Bluetooth Connection

1. Press the Power button to turn on the unit.
2. Press the Menu button to enter the menu screen.
3. Use the left / right directional arrows to select right side menu.
4. Use the up / down directional arrows to select Bluetooth column.
5. Press the “OK” button to enter Bluetooth menu.
6. Use the left/right directional arrows to select “ON”.
7. Turn on your external Bluetooth speaker and select Bluetooth pairing mode.
8. A few seconds later, an audio sound will prompt to notify you that the projector and speaker are connected.
9. After connecting, the projector will sound through the external Bluetooth speaker.

**NOTE:** When the BT can't connect to this device automatically, please enter the Bluetooth setup menu and select to reset BT. Then, the BT device will connect to the projector automatically

### **Disconnecting Bluetooth Device**

1. Press the Menu button to enter the menu screen.
2. Use the left / right directional arrows to select above menu.
3. Use the up / down directional arrows to select Bluetooth column.
4. Press the "OK" button to enter Bluetooth menu.
5. Use the left/right directional arrows to select "OFF" and disconnect Bluetooth.



# HDMI Operation

HDMI offers superior sound and picture quality, and is the easiest way to play media from a computer, Blu-Ray player, or other device with an HDMI output.

Requires an HDMI cable (not included) and a device with an HDMI output.

1. Using an HDMI cable, connect the HDMI 1 or 2 Input on the projector to the HDMI output on your media player or computer.
2. Set the projector's Source to the connected HDMI Input and use the controls on the connected device to select and play media.

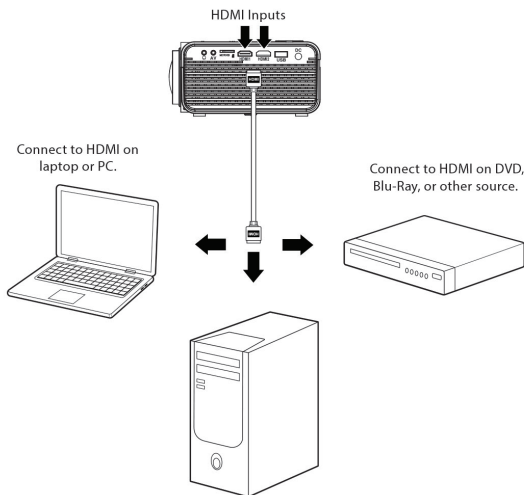

# Audio / Video Input

Requires a 3.5mm to RCA audio / video cable.

1. Connect the 3.5mm to RCA audio video cable to the AV input on the projector.
2. Connect the 3.5mm to RCA audio / video cable to the RCA stereo audio outputs and composite video output on the media player.
3. Set the projector's Source to AV and use the control on the connected player to select and play media.

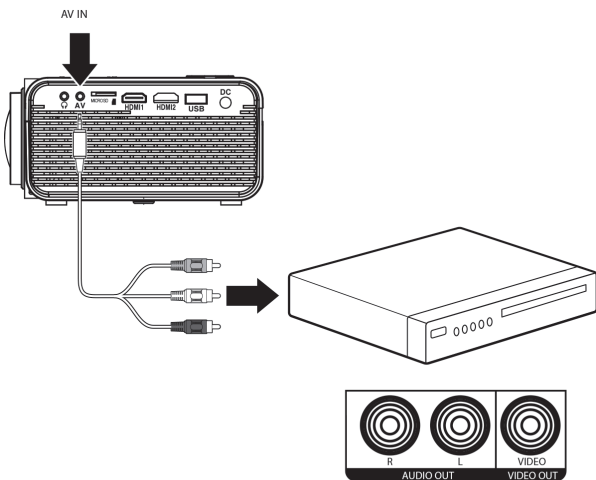

Connect AV cable (included) to media player's AV outputs.  
Audio Left Channel - White  
Audio Right Channel - Red  
Video - Yellow

## Computer Video (VGA)

**NOTE:** VGA connections do not support audio. You will need to use the computer's speakers to hear audio.

Requires a VGA cable (not included) and a desktop PC or laptop with a VGA output.

1. Using a VGA cable, connect the VGA Input on the projector to the VGA output on your computer.
2. Set the projector's Source to PC and use the controls on the computer to select and play media.

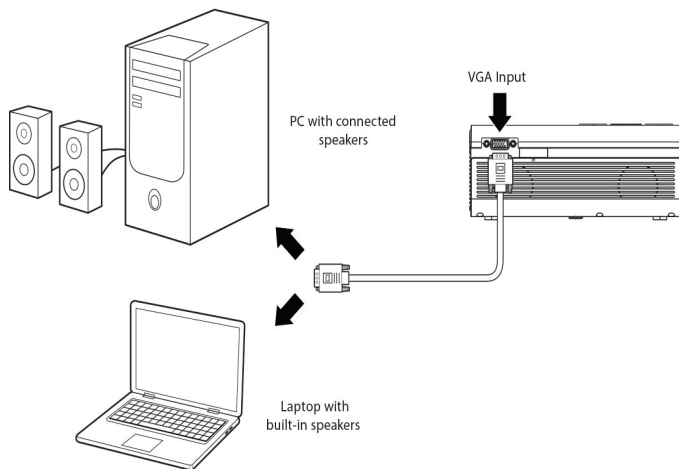

## External Audio

**NOTE:** Speakers must have their own power supply.

Requires a 3.5mm to RCA audio / video cable.

1. Using a 3.5mm to RCA stereo cable, connect the external powered speakers to the headphone jack on the projector.
2. The projector will automatically detect the connection and send audio signal to the speakers.

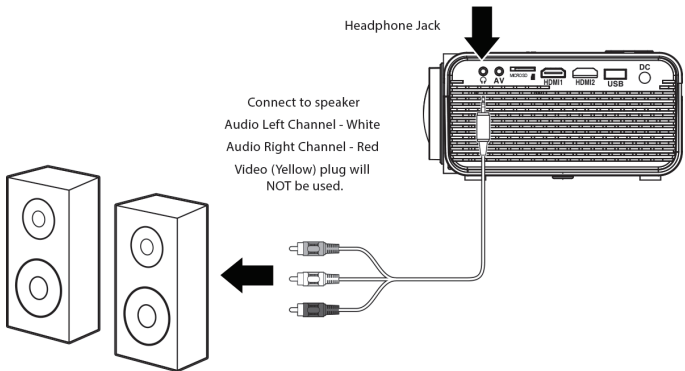

## Micro SD & USB Inputs

Supports Micro SD cards and USB flash drives up to 32GB.

Supports AVI, MOV file formats.

1. Turn off device and install USB or TF card.
2. Turn on device and press the Source button.
3. Use the arrow buttons to select Music / Photo / Movie, use directional arrows to select TF card or USB if necessary, then press the “OK” button to begin playing content from the connected storage device.

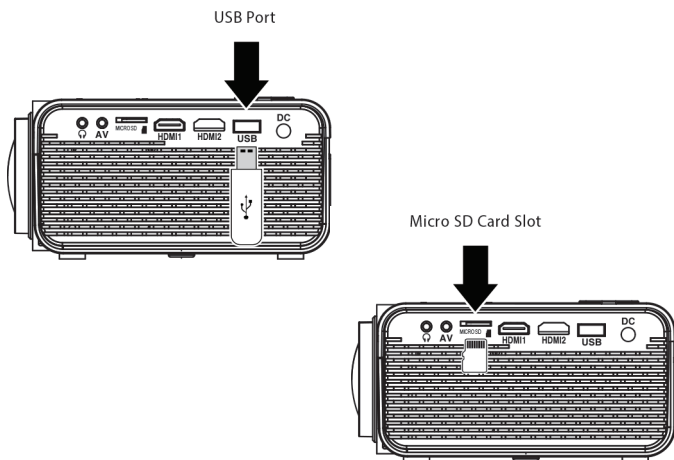

## DVD Playback

1. Press the Power button to turn on the unit, the power indicator light will turn green.
2. Press the Source button to enter and use the directional arrows to search for DVD mode.
3. Open the disc cover and insert a DVD or CD disc, make sure the label side is facing up, and close cover.
4. The player will scan the disc. Playback will begin automatically.

### Disc Handling:

- Do not leave discs near heat sources, in direct sunlight, or in high humidity.
- Store discs in their cases when they are not being used.
- Stacking discs or standing them at an angle without putting them in the case can cause the disc to warp.
- Do not touch the disc surface when handling a disc; hold it by the edge.
- Fingerprints, dust, dirt, or scratches on the disc can distort the picture or reduce sound quality. Always handle carefully and make sure discs are clean before use.
- Do not stick paper or tape onto the disc.
- Do not write on the disc with a marker, etc. Clean discs using a soft cloth, lightly wiping from center outwards.
- Do not use solvents such as benzene, commercially available cleaners not intended for CDs or anti-static spray/

## Specifications

Light Source Type	LED
HDMI Input Supported Video Resolution	1080p, 1080o, 720p, 576i, 480p, and 480i
Power Consumption	Operating 48W; Standby 0.8W
Power Input	DC 12V, 4A
Connect Included Adapter	
Included Adapter	Input: AC 100-240V, 50/60Hz
Connect DC Input of Unit	Output: DC12V, 4A
Display Color	16.7K
Projection Size	30-170 Inch
Signal Port	Video / VGA / HDMI
USB Port	Supports USB device up to 32 GB Supports mpeg1, Mpeg2, mpeg3, mp3, jpeg
Micro SD	Supports Micro SD card up to 32GB Supports mpeg1, Mpeg2, mpeg3, mp3, jpeg
Dimension	203 x 161 x 95 mm

# Support

If you have problems with your device, please consult the instructions in this manual. Please also visit us on the web at [www.naxa.com](http://www.naxa.com) to get up to the minute news, alerts, and documentation for your device. For additional assistance, please contact Naxa Technical Support.

## **NAXA Technical Support**

2320 East 49th St. Vernon, CA 90058

[http://www.naxa.com/naxa\\_support/](http://www.naxa.com/naxa_support/)

MADE IN CHINA