



Eviction
SERIES

a **B·I·C** America™ Company

OWNER'S MANUAL

Model RtR-EV1200 12" 475-Watt Front-Firing Powered Subwoofer

SPECIFICATIONS

Woofer

12" Custom Eviction Series Woofer with High Power Magnet

Power

475 Watts Peak, BASH Designed Amp

Frequency Response

25Hz - 200Hz

Variable/Adjustable Crossover

40Hz - 180Hz

Features

- Gold-plated Speaker Level Inputs
- RCA Input & Phase Switch
- Adjustable Volume, Auto On/Off
- Flared Port

Dimensions

17" H x 14³/₄" W x 17¹/₂" D

Finish

MDF Black Vinyl Cabinet

Limited Warranty

5 years on driver,
2 years on amplifier



NO USER SERVICEABLE PARTS ARE INSIDE.



WARNING:

TO REDUCE THE RISK OF FIRE OR ELECTRIC SHOCK, DO NOT EXPOSE THIS APPLIANCE TO RAIN OR MOISTURE



The lightning flash with arrowhead symbol within an equilateral triangle is intended to alert the user to the presence of uninsulated "dangerous voltage" within the product's enclosure that may be of sufficient magnitude to constitute a risk of electric shock to persons.

Le symbole éclair avec point de flèche à l'intérieur d'un triangle équilatéral est utilisé pour alerter l'utilisateur de la présence à l'intérieur du coffret de "voltage dangereux" non isolé d'ampleur suffisante pour constituer un risque d'électrocution.



The exclamation point within an equilateral triangle is intended to alert the user to the presence of important operating and maintenance (servicing) instructions in the literature accompanying the product.

Le point d'exclamation à l'intérieur d'un triangle équilatéral est employé pour alerter les utilisateurs de la présence d'instructions importantes pour le fonctionnement et l'entretien (service) dans le livret d'instruction accompagnant l'appareil.

RtR-EV1200 SAFETY INSTRUCTIONS

1. Read Instructions – Read all the safety and operation instructions before operating the RtR-EV1200.

2. Retain Instructions – Keep the safety and operating instructions for future reference.

3. Heed Warnings – Follow all warnings on the subwoofer and in these operating instructions.

4. Follow Instructions – Follow all operating and other instructions.

5. Water and Moisture – Do not use the subwoofer near water – for example, near a bathtub, washbowl, kitchen sink, laundry tub, in a wet basement or near a swimming pool.

6. Heat – Locate the subwoofer away from heat sources such as radiators, or other devices that produce heat.

7. Power Sources – Connect the unit only to a power supply of the type described in these operation instructions or as marked on the subwoofer and amp.

8. Power Cord Protection – Route power supply cords so that they are not likely to be walked upon or pinched by items placed upon or against them, paying particular attention to cords at plugs, convenience receptacles, and the point where they exit the subwoofer.

9. Object and Liquid Entry – Do not drop objects or spill liquids into the inside of the subwoofer.

10. Damage Requiring Service – Subwoofer should be serviced only by qualified service personnel when:

- A Sub's amp power-supply cord or the plug has been damaged; or
- B. Objects have fallen, or liquid has spilled into the subwoofer; or
- C. Subwoofer has been exposed to rain; or
- D. Subwoofer does not appear to operate or exhibits a marked change in performance; or
- E. The subwoofer has been dropped, or its chassis damaged.

11. Servicing – Do not attempt to service the subwoofer beyond those means described in this operating manual. For information regarding other service, please call B-I-C Service at 877-558-4242.

12. To prevent electric shock, do not use the subwoofer's polarized plug with an extension cord, receptacle or other outlet unless the blades can be fully inserted to prevent blade exposure.

Pour prévenir les chocs électriques ne pas utiliser cette fiche polarisée avec un prolongateur, un prise de courant ou une autre sortie de courant, sauf si les lames peuvent être insérées à fond sans laisser aucune partie à découvert.

13. Grounding or Polarization – Do not disable the grounding or polarization of the subwoofer.

14. Internal/External Voltage Selectors – Internal or external line voltage selector switches, if any, should only be reset and re-equipped with a proper plug for alternate voltage by a qualified service technician.

This apparatus does not exceed the Class A/Class B (whichever is applicable) limits for radio noise emissions from digital apparatus as set out in radio interference regulations of the Canadian Department of Communications.

ATTENTION — Le présent appareil numérique n'émet pas de bruits radio-électriques dépassant les limites applicables aux appareils numériques de class A/de class B (selon le cas) prescrites dans le règlement sur le brouillage radioélectrique édicté par les ministere des communications du Canada.

WARNING – To reduce the risk of fire or electric shock, do not expose this component to rain or moisture.

TABLE OF CONTENTS

SPECIFICATIONS.....	1
UNPACKING.....	3
PLACEMENT.....	3
AMPLIFIER PANEL.....	4, 5
HOOKUP METHOD A.....	6
HOOKUP METHOD B.....	7
7.2 SYSTEM DIAGRAM.....	8
INITIAL LISTENING TESTS..	9
TROUBLESHOOTING....	10, 11
240-VOLT CONVERSION....	12
REPAIR.....	12
WARRANTY.....	12

Congratulations on your purchase of an RtR-EV1200 powered subwoofer. It will give your stereo system unparalleled low frequency output!

Bass frequencies are critical to realistic sound reproduction. After you've hooked up your RtR-EV1200, you will discover just how much punch and depth you've been missing. No matter what kind of music or videos you listen to... whether you listen to them loud or soft, you will experience sound that is richer and fuller. Bass guitar and string bass will have more impact. You will be able to FEEL as well as hear percussion – just the way you would at a live performance. If you have an audio/video system, movies will come alive with thunderous sound effects that were never possible without the RtR-EV1200.

This manual will take you step-by-step through the setup and operating process of your RtR-EV1200. Reading this manual carefully will ensure you get maximum performance from your RtR-EV1200.

UNPACKING

Remove the RtR-EV1200 carefully from its carton to prevent any scuffing or scratching. Take a moment to inspect for any shipping damage. If you discover shipping damage, please contact your dealer and the shipping company immediately.

Please make sure to keep your sales receipt, it will establish the duration of your warranty.

PLACEMENT

Placement is extremely important because it dramatically affects the bass quality. An optimally placed subwoofer is much more powerful and nice sounding than a poorly placed one. Three factors need to be considered:

1) Distance from your main speakers – The best placement for your subwoofer is on the same wall as the main speakers. However, if you are not able to place your subwoofer on the same wall as your main speakers, avoid placing the subwoofer halfway between the front and back walls. This is where you get a strong null from your room's standing waves. No matter how powerful the subwoofer is, there will not be as much bass around the center of the room.

2) Distance from a wall outlet – Since the subwoofer requires AC power, it must be placed within 10 feet of a wall outlet. We don't recommend extending that range with an extension cord.

3) Positioning and Proximity to walls and corners – Physical placement of the subwoofer will have a definite impact on the frequency response and the perceived amount of subwoofer bass output. Because low frequencies have long wavelengths, they are influenced by proximity to a boundary such as a wall or floor.

(See Drawing A below) When you place the subwoofer well away from a wall, it will produce bass at a certain level. Move the subwoofer close to the wall, it will produce more output (about 3dB more). Putting the subwoofer in a corner will increase output another 3dB (6dB more than when placed away from walls and corners). The main thing to remember is you can place your subwoofer in many areas of your room dependent on how much bass you want. If you like a lot of heavy bass, put the subwoofer into a corner. If you like smoother, less obvious bass, move the subwoofer out into the room.

Since low bass waves are very large (up to forty feet or more across!), they tend to cancel and reinforce each other, causing places in the room where there are lots of bass and other places where there isn't very much bass at all. To locate the best place in your room to put your subwoofer, you can use a technique called the "subwoofer crawl". First place the subwoofer where you will be sitting (ex. couch or chair) in your listening area. Turn on music with steady/constant bass and walk around the room at/near knee level until you find the place where the bass sounds most accurate and balanced. This is where the subwoofer should be placed.

DRAWING A - Subwoofer placement

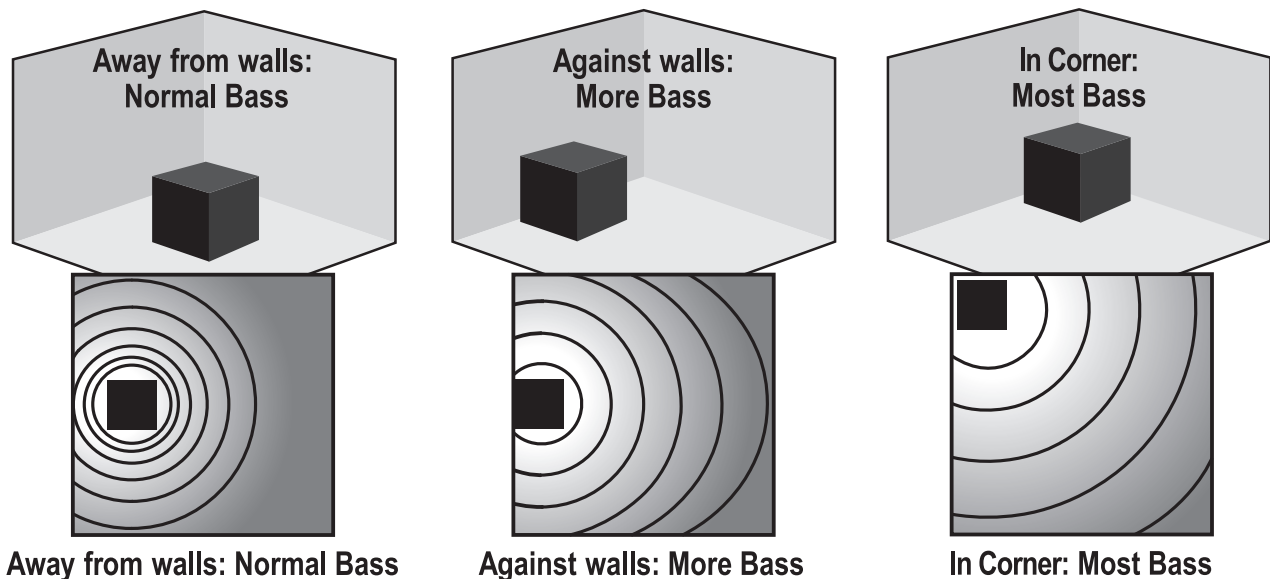

RtR-EV1200 AMPLIFIER PANEL

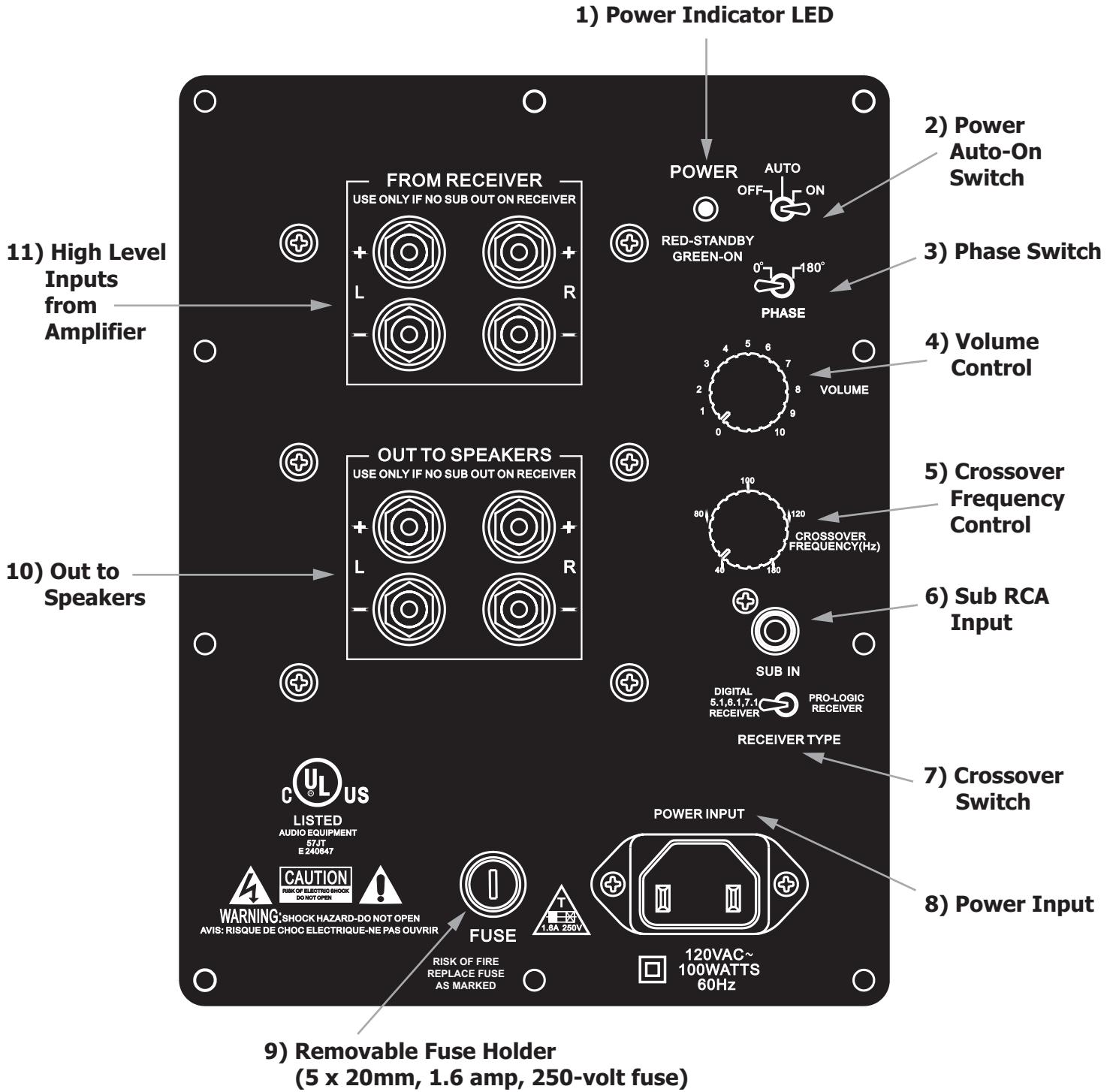

DRAWING B - Amp rear panel

RtR-EV1200 AMPLIFIER PANEL

- 1. POWER INDICATOR LED** – When the subwoofer is ON, this LED light will be green. When the subwoofer is in the STANDBY mode, it will be red.
- 2. POWER/AUTO ON SWITCH** – This toggle switch turns the subwoofer on and off. When the switch is in the OFF position, the subwoofer will not play. When the switch is in the ON position, the subwoofer will stay on at all times. When the switch is in the AUTO position, the subwoofer will automatically come on when bass frequencies are fed to it. Then after around 15-20 minutes after you stop playing music, the subwoofer will automatically go into STANDBY mode until more bass frequencies are fed to it. STANDBY mode uses very little electricity.
- 3. PHASE SWITCH** – This switch is used to set the subwoofer's phase to either normal "0°" or reverse "180°" (out of) phase. The physical location of your subwoofer and main speakers determines the phase setting that will sound best at your main listening position. Once you determine the placement of the subwoofer, you will need to try both positions of this switch to determine which setting sounds better in your room. If this requires using the "180°" mode, don't worry, there is nothing "abnormal" about it.
- 4. VOLUME CONTROL** – Rotating this knob clockwise increases the output level of the subwoofer. To start out, make sure that the VOLUME is turned all the way down (fully counterclockwise). Then, slowly adjust the volume to blend with the other speakers in your system. Care should be taken not to overdrive the subwoofer to the point of audible distortion.
- 5. CROSSOVER FREQUENCY CONTROL** – If you are connecting your subwoofer to a Dolby Digital type receiver which has a low level SUBWOOFER or LFE output that requires a subwoofer cable for connection, you will adjust and set your subwoofer crossover through your receiver, not by using this control. Please check your receiver owner's manual for instructions.

If your receiver is not digital (example: stereo only integrated amp or older Dolby Pro Logic receiver) and/or you are using the HIGH LEVEL INPUT speaker connections, you will use this control to set your crossover in your subwoofer. This control determines what lower part of the frequency spectrum will be reproduced by the subwoofer and what higher parts will be handled by your main speakers. It is a "crossover" control. Rotating the knob sets the point where all lower frequencies will be handled by the subwoofer and all higher frequencies will be routed to your main stereo speakers. As a starting point, if you are using left and right tower speakers, set the CROSSOVER FREQUENCY CONTROL to 80 Hz, with bookshelf speakers to 100 Hz, and with small mini speakers to 120 Hz.
- 6. SUB RCA INPUT** – This jack is used with a cable to connect your subwoofer to your receiver. This is the preferred connection. If you use this connection, you will not use #10 and #11.
- 7. CROSSOVER SWITCH** – If you are using a Dolby Digital receiver which has a low level SUBWOOFER or LFE output that requires a subwoofer cable for connection, set this switch to "Digital Receiver" so you can adjust your subwoofer crossover through your receiver. If your receiver is not digital (example: stereo only integrated amp or older Dolby Pro Logic receiver) and/or you are using the HIGH LEVEL INPUT speaker connections, set this switch to "Pro Logic Receiver" so you can adjust your crossover through your subwoofer.
- 8. POWER INPUT** – This connector is the AC power "in" for the power cord which is supplied with your RtR-EV1200.
- 9. REMOVABLE FUSE HOLDER** – By pushing in and turning counter-clockwise, you can remove and replace the fuse. Use only the correctly rated 5 x 20 mm, 1.6 amp 250-volt replacement fuses.
- 10. OUTPUT TO SPEAKERS** – If your receiver does not have a SUBWOOFER or LFE output, use these color coded binding posts to run speaker wire from your main left and right speaker terminals to these OUTPUT TO SPEAKER terminals. **Note:** These cannot be used in conjunction with SUB-IN low level inputs (See #6).
- 11. HIGH LEVEL INPUTS FROM AMPLIFIER** – If your receiver does not have a SUBWOOFER or LFE output, use these color coded binding posts to run speaker wire from your receiver's main left and right speaker terminals to these HIGH LEVEL INPUTS.

SUBWOOFER CONNECTION - METHOD A

Connecting to Receivers with a SUBWOOFER or LFE Output Jack

All Dolby Digital, DTS, THX, and Bass Management equipped receivers have a low level SUBWOOFER or LFE output jack. If you have this, you will use the METHOD A connection as shown below in Drawing C. This is the recommended and easiest connection. If your receiver does not have a low level SUBWOOFER or LFE output jack, you will use METHOD B (Drawing D) on Page 7 to connect your subwoofer to the receiver.

For this connection, you will need a mono interconnect cable with a male RCA jack on both ends. This can be purchased at the majority of electronics and audio stores. Make sure the length of your cable is long enough to reach from your receiver to your subwoofer location. The cable should lie flat with a little bit of slack to give some placement flexibility.

WIRELESS HOOKUP - If you prefer a wireless connection rather than using a subwoofer cable, you can connect your RtR-EV1200 wirelessly to your digital receiver with a BIC WTR-SYS kit. You can also add an unlimited amount of wireless subs to your system by adding BIC W-Receiver. Please contact BIC sales at 877-558-4242, ext. #1 for more information.

HOOKUP STEPS

- 1. IMPORTANT:** Make sure that ALL stereo system components including the subwoofer are turned OFF before proceeding.
- Locate the SUBWOOFER or LFE output connector on the rear of your receiver and connect one end of the RCA cable to it.
- Route the RCA cable to the subwoofer location (trying to minimize areas where it may be stepped on). Connect the other end of the cable directly to the SUB IN.
- Connect your main (and surround speakers if applicable) to the receiver according to the receiver's owner manual.
- Connect the included power cord to the **POWER INPUT (#1)** on the back of your RtR-EV1200. Then connect its plug to an **AC outlet ONLY**. Since your RtR-EV1200 draws a moderately high amount of current, we do not recommend plugging it into a "convenience" outlet (switched or unswitched) found on the back of receivers and other stereo components.
- Set the **CROSSOVER SWITCH (#2)** to the "Digital Receiver" position (on left). This will enable you to set the crossover from your digital receiver and disable the **CROSSOVER FREQUENCY CONTROL (#3)** on the back of your RtR-EV1200 (also see Page 5, #5). Refer to your receiver's owner manual for instructions on how to set your crossover. You also need to make sure the SUBWOOFER ON setting is set in your receiver. Otherwise, the receiver will send no signals to the subwoofer and there will be no sound.
- Set the **PHASE SWITCH (#4)** to 0°. You will later need to follow instructions on Page 5, #3 for room settings.
- You are now ready to turn your **POWER SWITCH (#5)** on and enjoy the deep bass you have been waiting for. You can learn more about the "auto" feature on this switch on Page 5, #2.
- See Page 9 for "Initial Listening Test".

DRAWING C
Connecting with a Subwoofer or LFE output jack.

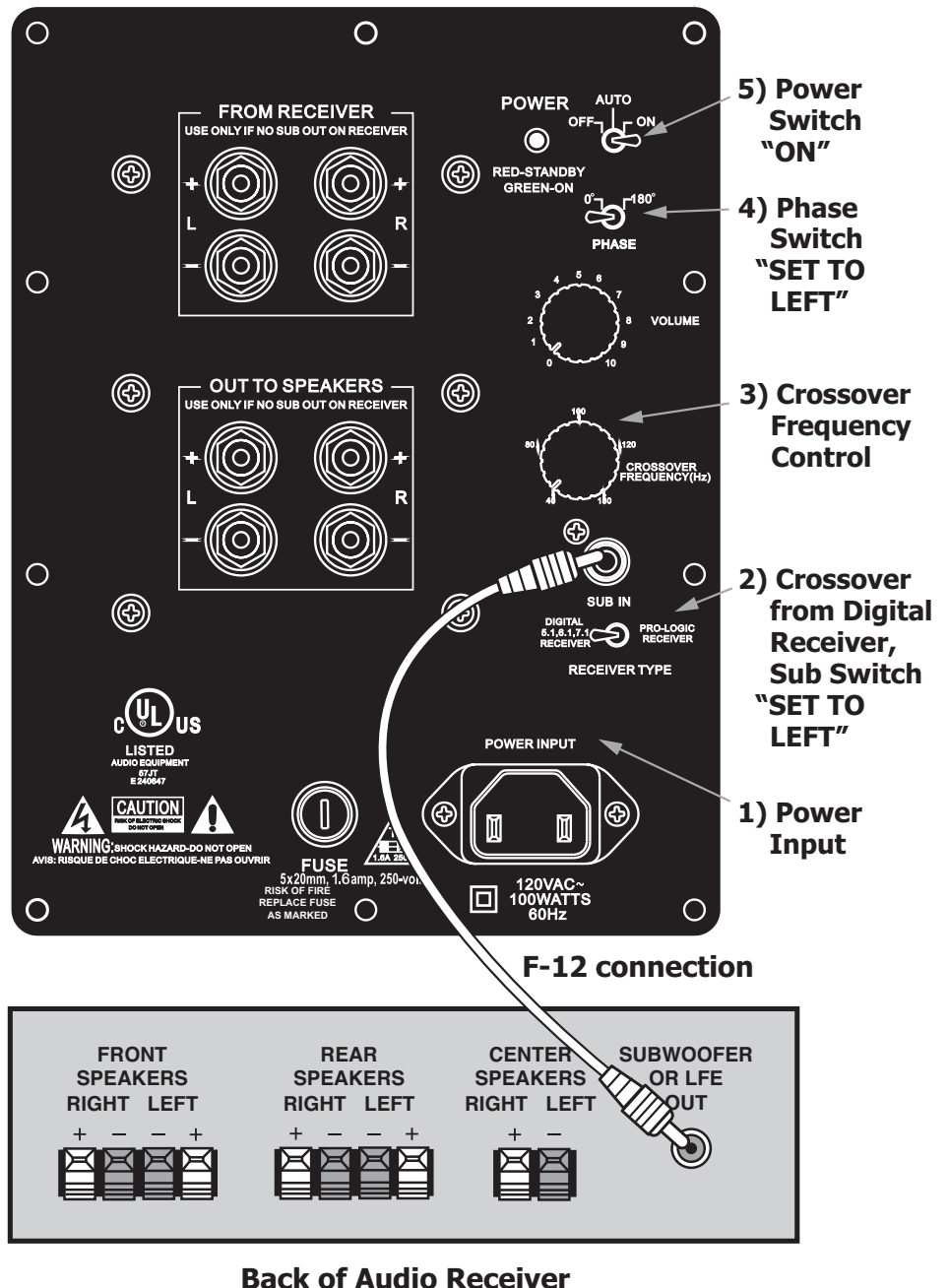

SUBWOOFER CONNECTION-METHOD B

Connecting to Receivers with NO SUBWOOFER or LFE Output Jack

If your receiver does not have a low level SUBWOOFER or LFE output jack (for example, older Dolby Pro Logic receivers or stereo-only integrated amps), you will use the method shown below in Drawing D to connect your subwoofer to the receiver.

For this connection, you will need speaker wire to run from your receiver to sub (for subwoofer HIGH LEVEL INPUTS), and then from the sub to speakers (for OUTPUT TO SPEAKERS). Speaker wire can be purchased at the majority of electronics and audio stores. We recommend 16-18 gauge wire. The lower the number gauge, the thicker the wire is. For longer runs, use thicker wire. Make sure the length of your wire is long enough to give a little bit of slack to for some placement flexibility.

HOOKUP STEPS

1. IMPORTANT: Make sure that ALL stereo system components including the subwoofer are turned OFF before proceeding.

2. Measure the length of wire you will need, and then cut and strip $\frac{1}{2}$ " of the insulation from each end of the four wires you will run for hookup.

3. Locate the front left and right main speaker terminals on the rear of your receiver and connect two wires to these terminals.

4. Route the speaker wire from the subwoofer location (trying to minimize areas where it may be stepped on). Connect the other ends of the speaker wire directly to the **HIGH LEVEL INPUTS FROM AMPLIFIER #1**.

Make sure the left and right wires are hooked to the proper left and right channel and that all (+) terminals go to (+) terminals and all (-) terminals go to (-) terminals. Most speaker wire has some marker to help you keep track of the polarity such as color coding or writing. **5.** Connect the two remaining speaker wires from **OUT TO SPEAKERS #2** to your main left and right speakers. As in step 4 above, make sure the left and right channels and (+) and (-) polarity are correct.

6. Connect the included power cord to the **POWER INPUT (#3)** on the back of your RtR-EV1200. Then connect its plug to an **AC outlet ONLY**. Since your RtR-EV1200 draws a moderately high amount of current, we do not recommend plugging it into a "convenience" outlet (switched or un-switched) found on the back of receivers and other stereo components.

7. Set the **CROSSOVER SWITCH (#4)** to the "Pro Logic Receiver" position (on right). This will enable you to set the crossover from your subwoofer with the **CROSSOVER FREQUENCY CONTROL (#5)** on the back of your RtR-EV1200 (also see Page 5, #5). In most cases, setting the crossover to the 90Hz setting on the control will yield the best results. **8.** Set the **PHASE SWITCH (#6)** to 0° . You will later need to follow instructions on Page 5, #3 for room settings.

9. You are now ready to turn your **POWER switch (#7)** on and enjoy the deep bass you have been waiting for. You can learn more about the "auto" feature on this switch on Page 5, #2.

10. See Page 9 for "Initial Listening Test".

DRAWING D
Connecting with Speaker wire to HIGH LEVEL Inputs and Outputs.

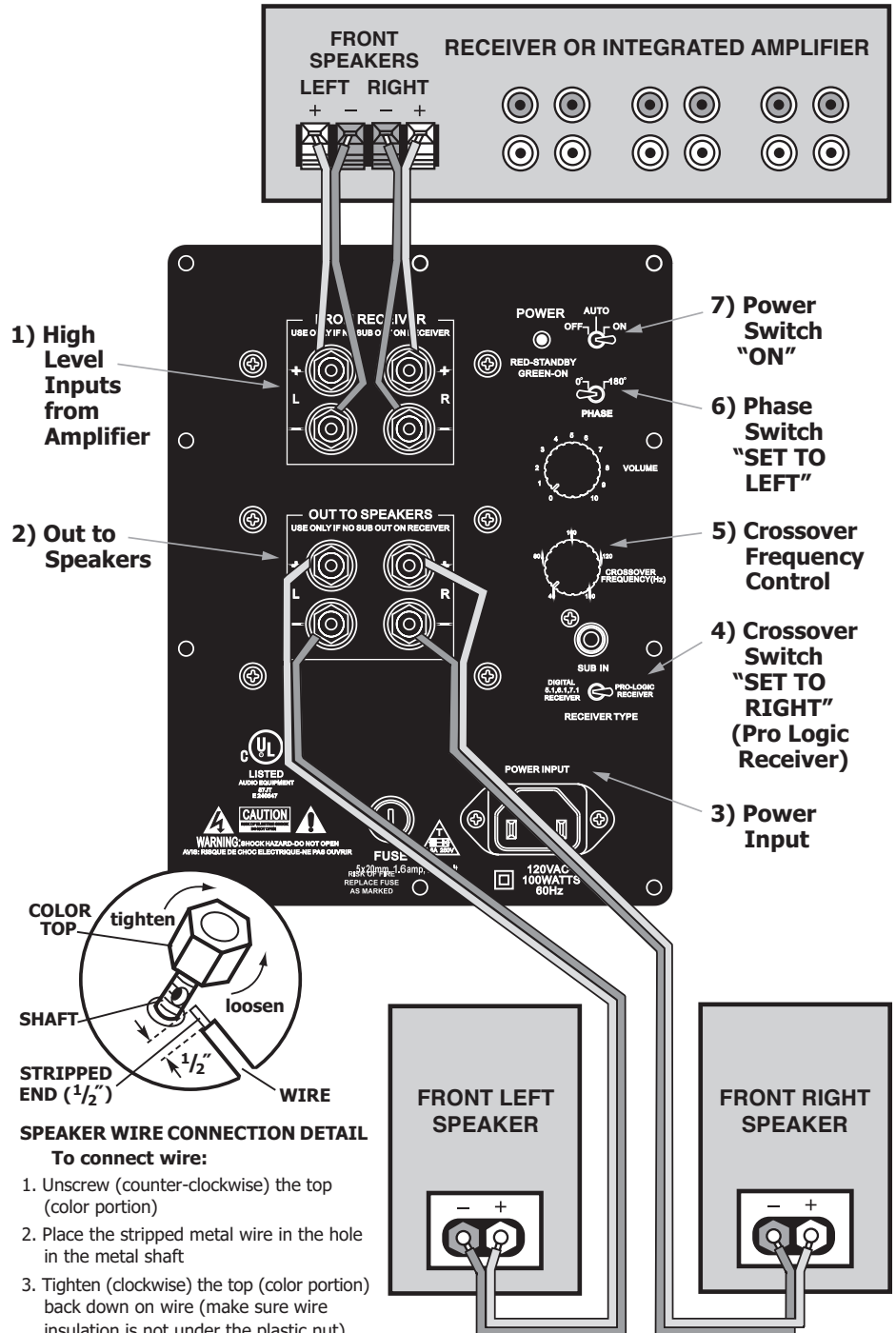

SURROUND YOURSELF

(7.2 Configuration)

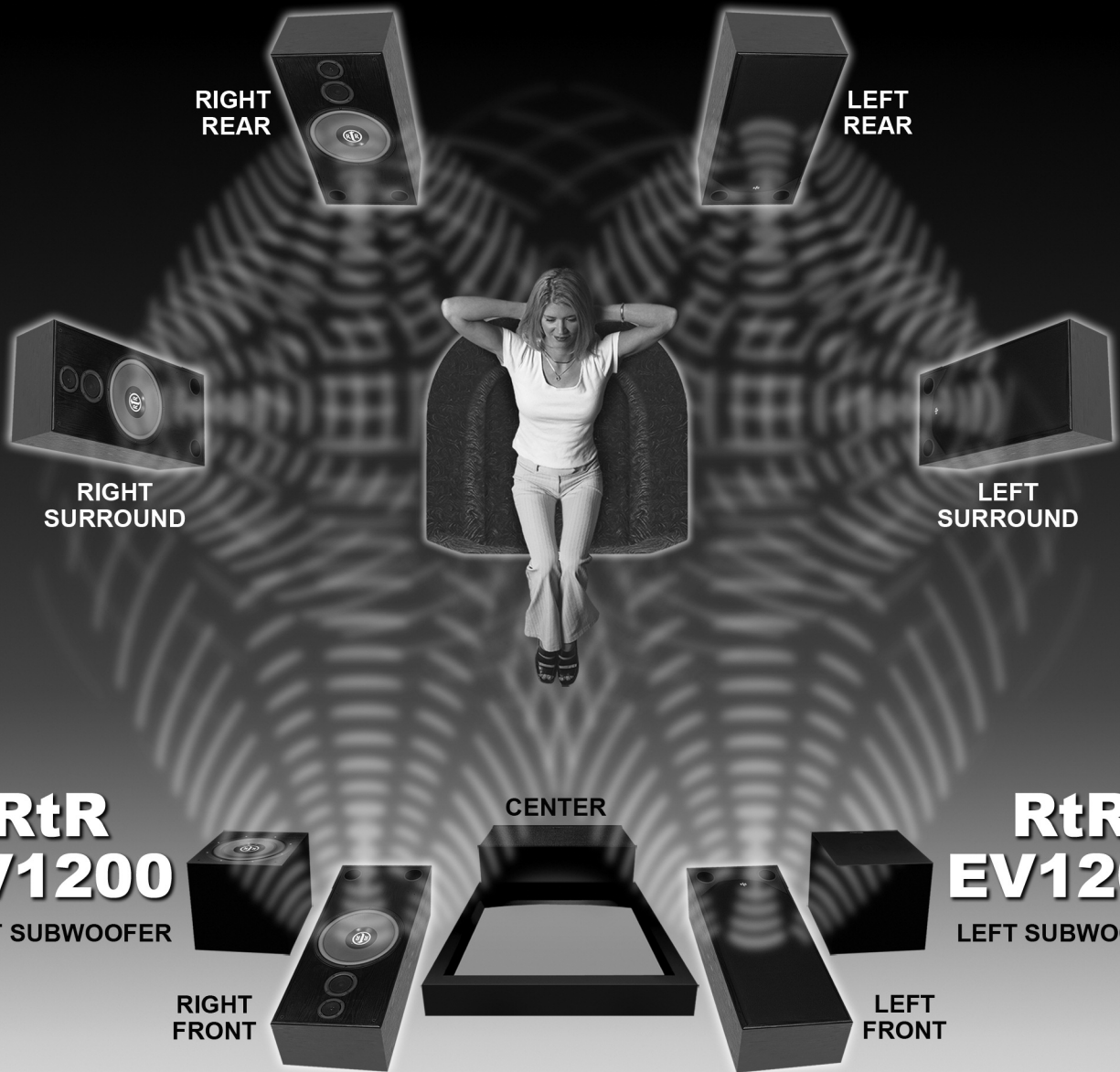

RtR
EV1200

RIGHT SUBWOOFER

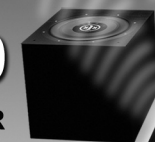

RIGHT FRONT



CENTER

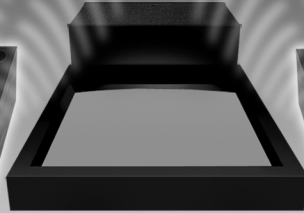

LEFT FRONT

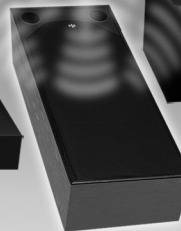

RtR
EV1200

LEFT SUBWOOFER



a **B•I•C** America™ Company

Top-Rated Loudspeakers Since 1973

INITIAL LISTENING TEST

It's now time to test the RtR-EV1200 subwoofer in your listening environment.

1. Before turning your stereo system and subwoofer on, double-check all connections.
2. Turn the volume controls on both the subwoofer and your audio receiver all the way down (fully counterclockwise) and check that the **PHASE SWITCH** is set to 0° and **CROSSOVER SWITCH** is set to the proper setting (see Page 5, #7).
3. Turn your stereo system and then subwoofer to the ON position by using the **POWER AUTO-ON SWITCH**. (See details on Page 5, #2 regarding AUTO position after performing the "Initial Listening Test").
4. Confirm that the subwoofer's green **POWER INDICATOR LED** is glowing. If it isn't, check the power connections between the subwoofer and the wall outlet.
5. Play a musical selection that you are familiar with. Pick a song that has regular low bass beats. Advance the audio receiver's volume control up to a normal listening level. If you don't hear sound through your main speakers, turn off the system and check connections. Also consult the troubleshooting tips.
6. If sound is coming out of your main speakers, slowly turn the sub amp's **VOLUME CONTROL** clockwise until you hear noticeable additional bass. If you don't hear bass by the time you have advanced the subwoofer's **VOLUME CONTROL** halfway, turn off the system and check connections. Also consult the troubleshooting tips.
7. Adjust the sub amp's **VOLUME CONTROL** until you are satisfied with the amount of bass (care should be taken not to overdrive the subwoofer to the point of audible distortion). You may want to try several different movies, tapes, compact discs or DVDs while determining how high to adjust the volume. The amount of bass will vary from disc to disc and between different types of music.
8. Now that you have adjusted the quantity of bass through the volume, it's time to work on the quality of the bass by experimenting with subwoofer placement in your room and adjusting the crossover and **PHASE SWITCH**.
 - a. **Subwoofer Placement** (Also See Page 3 "Placement") – Subwoofer placement is extremely important because it dramatically affects the bass quality. An optimally placed subwoofer is much more powerful and nice sounding than a poorly placed one. While playing music, move the subwoofer around, in and out of corners, closer and farther from the wall, etc. – as much as the power cord or other connections will allow to determine the best placement. You may also want to try the "subwoofer crawl" technique found in the last paragraph of "Placement", Page 3.
 - b. **Crossover** – If you have hooked your subwoofer to a Dolby Digital, DTS, THX, or Bass Management receiver, you will need to refer to your receiver's user manual for instructions on how to adjust and set your subwoofer crossover from the receiver.

If your receiver is not digital (example: older Dolby Pro Logic or stereo-only integrated amp) and/or you are using the **HIGH LEVEL INPUT** speaker connections, you will use the **CROSSOVER FREQUENCY CONTROL** on the back of your subwoofer's amp to set your crossover from your subwoofer. Change the **CROSSOVER FREQUENCY CONTROL** to higher and lower settings. If the crossover frequency is set too high, you'll start to hear low midrange (voices and instruments) through it. This will negatively affect the stereo imaging of your main speakers. If this occurs, lower the crossover frequency setting until you hear only bass from the subwoofer. If the crossover frequency is set too low, you simply won't get much output from the subwoofer. As a starting point, if you are using left and right tower speakers, set the **CROSSOVER FREQUENCY CONTROL** to 80 Hz, with bookshelf speakers to 100 Hz, and with small mini speakers to 120 Hz.
 - c. **PHASE SWITCH** – Have someone change the **PHASE SWITCH** back and forth from 0° to 180° while you sit in the main listening position. Leave the switch in the position where bass sounds most accurate and balanced.
9. After you are satisfied with the output of your subwoofer, you can make all your volume settings through your receiver's volume control. The only time you might want to re-adjust the subwoofer amp's **VOLUME CONTROL** is when you encounter a musical selection that has abnormally low – or high – bass.

TROUBLESHOOTING GUIDE

If you are having a problem with your subwoofer, please read through this "Trouble Shooting Guide". Many times problems are actually caused by other items in the system or the subwoofer's interaction with those items. These problems can easily be resolved with this guide.

Problem	Cause	Solution
1) HUMMING OR BUZZING NOISE	You have a Ground Loop or problem with other equipment. This causes the vast majority of hum related complaints. The electrical grounds of the components in your system are not at the same electrical potential.	A very common ground loop source is cable TV or satellite cabling. Very few installers take the time to ground the cable to the house ground, causing a 60 Hz hum that the subwoofer reproduces. Disconnect the coaxial cable from your TV or cable box. If the hum goes away, the cable is the cause. In that case contact your cable company or get an inexpensive 75 ohm ground loop isolator on line or at a local electronics store. Ground loops can also come from faulty electrical wiring in your home. Consult a licensed electrician to evaluate and possibly repair the AC wiring in your home.
	You have an amplifier problem.	<ul style="list-style-type: none"> • Disconnect all interconnects from the amplifier. If still hums, call or email technical support.
	Your speaker wires or interconnects are the cause.	<ul style="list-style-type: none"> • It is possible that some cables have a poor or broken ground due to poor construction, oxidation, or damage. Also, poorly shielded cables can potentially pick up noise. Try another cable or speaker wire. Also, move the signal cable away from AC cables, power transformers, or other EMI sources.
	A light dimmer or other triac based (SRC) device is on the same AC circuit.	<ul style="list-style-type: none"> • Use an AC line filter or plug the unit into a different circuit.
2) Subwoofer thumps when the system is being turned on and off.	Noise is being generated by upstream equipment.	<ul style="list-style-type: none"> • When you shut down your equipment, turn off the subwoofer first. When powering up, turn on the subwoofer last.
3) Subwoofer goes into STANDBY MODE while material is playing.	The source is not providing enough signal.	<ul style="list-style-type: none"> • The unit is going into STANDBY mode during the quiet passages. Try turning the source signal up. On a Dolby Digital receiver, turn the SUBWOOFER level up in the SPEAKER SET-UP menu. After you turn the signal up, turn down the volume knob on the subwoofer to compensate. • An alternative is to turn the subwoofer ON/AUTO/OFF switch to the ON position. When playing, it does not use any more power and does not affect reliability. • Check to see if the crossover through the receiver is set too low, or if setting crossover from the sub, check to see if the crossover set through the sub is set too low. This will greatly reduce the signal going to the sub and hence make it go into STAND BY MODE.

Problem	Cause	Solution
4) NO OUTPUT FROM SUB LED DOES NOT LIGHT UP	AC power is not getting to the amplifier.	<ul style="list-style-type: none"> • Make sure the switch on the back of the sub is in the "ON" position. • Check that you are using the correct power cord and that it is plugged in securely at both ends and make sure that the AC outlet the subwoofer is plugged into is working. Try another power cord.
	Fuse is blown or subwoofer amplifier is not working.	<ul style="list-style-type: none"> • If you have determined you are using the correct power cord, it is plugged in securely at both ends, and your AC outlet has power but the LED is still not lighting up, check your fuse (see #9, Page 5). If this does not correct the problem, your amplifier needs service. Please contact BIC Tech Support.
5) NO OUTPUT FROM SUB LED LIGHTS UP GREEN with Power Switch set to AUTO	Connection between 12" woofer and sub amplifier is loose or not connected.	<ul style="list-style-type: none"> • Unplug your subwoofer. Unscrew the outer screws on the back of the sub amp. Wiggle the amp out and make sure both (+) and (-) leads from the amp are securely connected to the (+) and (-) leads on the woofer. If not, this will solve the problem.
	12" woofer or sub amplifier is faulty.	<ul style="list-style-type: none"> • Determine whether the woofer or amplifier is defective. <p>Unplug your subwoofer. Unscrew the outer screws around the woofer. Take the 12" woofer out of the cabinet and perform one of the testing steps below:</p> <ol style="list-style-type: none"> 1) Touch the woofer's (+) and (-) terminals to the (+) and (-) terminals on a 9-volt battery. If you hear a popping noise, the woofer is good and the amp needs repair. If you do not hear a popping noise, the woofer is bad. 2) Touch the woofer's (+) and (-) terminals to the (+) and (-) leads of a speaker wire connected to a main channel of your receiver. If the woofer plays fine, then the amp needs repair. If it does not play, then the woofer is bad.
6) NO OUTPUT FROM SUB LED LIGHTS UP RED with Power Switch set to AUTO	The subwoofer is not receiving a signal.	<ul style="list-style-type: none"> • Make sure your digital receiver is set to "SUB ON". • Recheck the connections between the receiver and the subwoofer.
	Subwoofer amplifier may not be not working. See solution to troubleshoot.	<ul style="list-style-type: none"> • Set the subwoofer level to a minimum. Use a different RCA cable to hook the sub to a DVD players analog output or to an MP3 player. Play some music and slowly turn the volume up on the sub. If the sub plays, then the sub is fine and the problem lies either in the subwoofer cable, the setting on the receiver, or you have connected to the wrong jack on the receiver. If still no sound, contact BIC Tech Support.
7) LOW BASS OUTPUT from SUB	Volume level on subwoofer or receiver's subwoofer output is too low.	Increase the volume control located on the back of the subwoofer and the subwoofer level or LFE level on the receiver or other source. It is best to set the level of the subwoofer relative to the other speakers.
	Subwoofer is not placed correctly.	See "Placement" Page 3 of this manual.
8) LITTLE/NO SOUND from one main speaker	You used speaker level connections and have mixed up the polarity of the wires, thus shorting one channel of the main amplifier.	<ul style="list-style-type: none"> • Correct the polarity of the speaker wires by matching the (+) and (-) from the receiver/amplifier to the (+) and (-) of the subwoofer's speaker level input.

CARING FOR YOUR RtR-EV1200 SUBWOOFER

The RtR-EV1200 enclosure is finished in a very high quality polymer laminate covering that is both attractive and excellent protection for the wood cabinet. To remove dirt or fingerprints use a damp, soft cloth. You may also use high-quality furniture polish on the wood laminate to maintain the original luster.

WARRANTY INFORMATION

We suggest that you read the LIMITED WARRANTY completely to fully understand your warranty/service coverage. **Be sure to save the sales receipt in a safe place. It will be necessary for warranty service.**

If you believe your RtR-EV1200 requires service, please first check the "Troubleshooting Guide" on page 10 and 11 of this manual. Many times problems are actually caused by other items in the system or the subwoofers interaction with those items. If you require service, please contact us at 877-558-4242, ext. 2. Our techs will then assist in determining what part requires service and we will, at our option, repair or replace the defective part.

RtR-EV1200 Powered Subwoofer Limited Warranty

If the RtR-EV1200 system proves to be defective in materials or workmanship within five years (two years on the amplifier) from the date of the original customer's purchase, we will, at our option, repair or replace the defective part.

***DISCLAIMER** THE WARRANTY STATED HERE-IN IS IN LIEU OF ALL OTHER WARRANTIES, EXPRESS OR IMPLIED, INCLUDING MERCHANTABILITY AND FITNESS FOR PARTICULAR PURPOSE AND ALL OTHER LIABILITIES AND OBLIGATIONS OF B·I·C AMERICA, ALL OF WHICH ARE EXPRESSLY DISCLAIMED. B·I·C AMERICA HAS NOT MADE AND DOES NOT HEREBY MAKE ANY OTHER REPRESENTATION, WARRANTY OR COVENANT WITH RESPECT TO THE CONDITION, QUALITY, DURABILITY, DESIGN, OPERATION, CAPACITY, FITNESS FOR USE OR SUITABILITY OF THE B·I·C ELECTRONIC PRODUCT.

Exclusion of Certain Damages

B·I·C America's liability for any defective product is limited to repair or replacement of the product at our option. B·I·C America shall not be liable for incidental or consequential damages of any kind or character because of product defects. Some states do not allow limitations on how long an implied warranty lasts and/or do not allow the exclusion or limitation of incidental or consequential damages, so the above limitations and exclusions may not apply.

This Warranty Does Not Cover:

- Damage caused by abuse, accident, misuse, negligence, or improper operation.
- Products that have been altered or modified.
- Any product whose serial number has been altered, defaced, or removed.
- Normal wear and maintenance.
- Damages caused by shipping. (All claims for shipping damage must be made with the carrier.)

Warranty Service

Warranty service must be performed by a B·I·C authorized service center. **All warranty repairs must be accompanied by the original bill of sale and a B·I·C warranty claim form.** No other documents are acceptable or required. This warranty gives you specific legal rights, and you may also have other rights which vary from state to state.

Due to our continual efforts to improve product quality as new technology and techniques become available, B·I·C America reserves the right to revise its Speaker Systems specifications without notice.



B·I·C America

925 N. Shepard Street
Anaheim, CA 92806

1-877-558-4242 (4BIC)
www.bicamerica.com