



User's manual

CLP99287/CLP99387/CLP99447/
CLP99457/CLP99487/CLP99547/
CLP99557/CLP99587

DECT 6.0 cordless telephone/
answering system with
BLUETOOTH® wireless technology



Congratulations

on your purchase of this AT&T product. Before using this AT&T product, please read the **Important safety information** section on pages 200-202 of this manual. Please thoroughly read this user's manual for all the feature operations and troubleshooting information necessary to install and operate your new AT&T product. You can also visit our website at **www.telephones.att.com** or call **1 (800) 222-3111**. In Canada, dial **1 (866) 288-4268**.

This telephone meets the California Energy Commission regulations for energy consumption. Your telephone is set up to comply with the energy-conserving standards right out of the box. No further action is necessary.

This telephone system is compatible with certain AT&T DECT 6.0 cordless headsets and speakerphones. Visit **www.telephones.att.com/accessories** for a list of compatible cordless headsets and speakerphones.

Model number: CLP99287 (two handsets)

CLP99387 (three handsets)

CLP99447/CLP99457/CLP99487 (four handsets)

CLP99547/CLP99557/CLP99587 (five handsets)

Type: DECT 6.0 cordless telephone/answering system with
BLUETOOTH® wireless technology

Serial number: _____

Purchase date: _____

Place of purchase: _____

Both the model and serial numbers of your AT&T product can be found on the bottom of the telephone base.

Save your sales receipt and original packaging in case it is necessary to return your telephone for warranty service.



Telephones identified with this logo have reduced noise and interference when used with most T-coil equipped hearing aids and cochlear implants. The TIA-1083 Compliant Logo is a trademark of the Telecommunications Industry Association. Used under license.



The ENERGY STAR® program (www.energystar.gov) recognizes and encourages the use of products that save energy and help protect our environment. We are proud to mark this product with the ENERGY STAR® label indicating it meets the latest energy efficiency guidelines.

The *Bluetooth*® word mark and logos are owned by Bluetooth SIG, Inc. and any use of such marks by Advanced American Telephones and its parent, VTech Holdings Limited, is under license. VTech Holdings Limited is a member of Bluetooth SIG, Inc. Other trademarks and trade names are those of their respective owners.

© 2017-2021 Advanced American Telephones. All Rights Reserved. AT&T and the AT&T logo are trademarks of AT&T Intellectual Property licensed to Advanced American Telephones, San Antonio, TX 78219. Printed in China.

Parts checklist

Your telephone package contains the following items. Save your sales receipt and original packaging in the event warranty service is necessary.

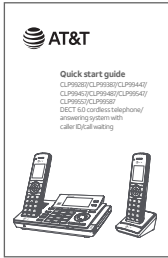

User's manual



Quick start guide



Telephone base



Cordless handset
(2 for CLP99287)
(3 for CLP99387)
(4 for CLP99447/CLP99457/
CLP99487)
(5 for CLP99547/CLP99557/
CLP99587)

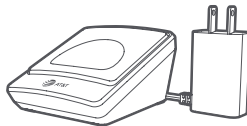

Charger for cordless handset
with power adapter installed
(1 for CLP99287)
(2 for CLP99387)
(3 for CLP99447/CLP99457/
CLP99487)
(4 for CLP99547/CLP99557/
CLP99587)



Battery for cordless handset
(2 for CLP99287)
(3 for CLP99387)
(4 for CLP99447/CLP99457/
CLP99487)
(5 for CLP99547/CLP99557/
CLP99587)

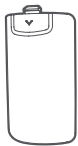

Battery compartment cover
(2 for CLP99287)
(3 for CLP99387)
(4 for CLP99447/CLP99457/
CLP99487)
(5 for CLP99547/CLP99557/
CLP99587)



Wall-mount bracket

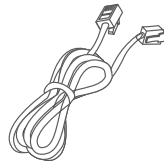

Telephone line cord



Power adapter for
telephone base

User's manual

CLP99287/CLP99387/CLP99447/

CLP99457/CLP99487/CLP99547/

CLP99557/CLP99587

DECT 6.0 cordless

telephone/answering system with

BLUETOOTH® wireless technology



Table of contents

Getting started

Installation	1
Quick reference guide - handset.....	2
Quick reference guide - telephone base	6
Telephone base and charger installation	10
Telephone base installation.....	10
Charger installation.....	11
Battery installation and charging	12
Battery backup mode	15
To activate the mode	15
Operation	15
Installation options	16
Tabletop to wall-mount installation	16
Wall-mount to tabletop installation	17
Introducing Bluetooth	18
Connect to Cell™ application.....	20
Glossary of terms.....	21
Bluetooth setup	22
Add a cell phone	22
Add a headset	24
Auto connection	26
Bluetooth connection from idle mode	26
Device list and connection	26

Review the device list.....	27
Connect/disconnect an active device	27
Remove a paired device	28
Replace an active device	29
Download directory.....	30
Interruption to directory download.....	32
View the directory download information	33
Change PIN.....	34
Cell ringer	34
Remote voice control.....	35
Activate remote voice control.....	36

Telephone settings

Handset and telephone base settings	38
Ringer volume	39
Ringer tone.....	40
Set date/time.....	41
LCD language.....	42
Caller ID announce	43
Set speed dial voicemail number	44
Voicemail (visual message waiting) indicator	44
Clear voicemail indication.....	45
Key tone	46

Use caller ID to automatically set date and time.....	47
Home area code	48
Cell area code	49
Dial mode	50
QUIET mode.....	51
No line alert.....	52
Cell alert	52

Telephone operation

Make, answer and end a call	53
Make, answer or end a home call	53
Call waiting on the home line	54
Make, answer or end a cell call	55
Call waiting on the cell line	56
Answer an incoming cell call while on a home call.....	57
Answer a home call while on a cell call	58
Conference calls.....	59
Conference home and cell calls.....	59
Options while on calls	60
Handset speakerphone	60
Volume control.....	60
Silence the ringer	61
Mute.....	61
Temporary tone dialing	62
Hold	62
Equalizer	63
Chain dialing	63
Redial	66
Review the redial list.....	66
Dial a redial entry	66
Save a redial entry to the directory.....	69
Delete a redial entry.....	70
Handset locator.....	71

Multiple handset use

Join a call in progress	72
Intercom.....	73
Answer an incoming call during an intercom call.....	75
Call transfer using intercom	76
Push-to-talk (PTT).....	78
Turn PTT on or off	78
PTT call to a single device	79
PTT call to multiple devices	81
Answer a PTT call	83
Change a one-to-one PTT call to an intercom call	84
Answer an incoming call during a PTT call.....	84
Make an outgoing call during a PTT call.....	85
End or leave a PTT call.....	85

Directory

About the directory.....	86
Create directory entries	87
Create a new entry in the home directory.....	87
Dialing keys	89
Add a predialed telephone number to the directory	90
Review the directory.....	91
Review directory entries	91
Search the directory	92
3-character alphabetical search	92
Dial a directory entry.....	92
Dial, edit or delete a directory entry.....	93
Edit a directory entry	93
Edit the type of a directory entry	95
Delete a directory entry	95
Remove a downloaded directory.....	96

Caller ID

About caller ID.....	97
Information about caller ID with call waiting.....	97
Caller ID log.....	98
How the caller ID log works.....	98
Missed (new) call indicator.....	98
Memory match.....	98
Caller ID operation.....	99
Review the caller ID log.....	99
View dialing options.....	100
Dial a caller ID log entry.....	100
Save a caller ID log entry to the directory.....	101
Delete caller ID log entries.....	106
Reasons for missing caller ID information.....	107

Smart call blocker

About Smart call blocker*.....	108
Call categories.....	109
Call controls.....	110
Call block settings.....	112
Set Smart call blocker on/off.....	112
Control home calls without numbers.....	112
Control uncategorized home calls.....	114
Block list.....	116
Allow list.....	122
Star name list.....	128
Screening announcements.....	132
Voice guide to set Smart call blocker.....	135
Allowed calls.....	136
Allow home calls without numbers.....	136
Allow uncategorized home calls.....	137
Blocked calls.....	138
Block home calls without numbers.....	138

Block uncategorized home calls.....	139
Screen home calls without numbers.....	140
Answer call once.....	141
Send call to answering system.....	142
End call.....	142
Screen uncategorized home calls.....	143
Allow call once.....	145
Always allow.....	145
Block call.....	146
Send call to answering system.....	146
Option while on a call.....	147

Answering system

Answering system settings.....	148
Announcement.....	148
Answer on/off.....	152
Voice guide to set Answering system.....	154
Call screening.....	155
Number of rings.....	156
Remote access code.....	157
Message alert tone.....	158
Recording time.....	159
About the answering system.....	160
Answering system and voicemail indicators.....	160
Use the answering machine and voicemail together.....	161
Message capacity.....	161
Voice prompts.....	162
Call screening.....	162
Call intercept.....	163
Temporarily turn off the message alert tone.....	163
Message playback.....	164
Options during playback.....	165
Delete all old messages.....	166
Record and play memos.....	167
Record a memo.....	167

Remote access 168

Appendix

Add and register handsets/
headsets/speakerphones 170

Register a handset to the
telephone base 170

Deregister handsets 172

Deregister all handsets from
the telephone base 172

Alert tones and lights 173

Handset screen icons 173

Telephone base screen icons 174

Handset alert tones 175

Telephone base alert tones 176

Lights 177

Display screen messages 178

Screen messages 178

Troubleshooting 183

Maintenance 199

Important safety information 200

Safety information 200

Especially about cordless
telephones 201

Precautions for users of
implanted cardiac
pacemakers 202

ECO mode 202

Especially about telephone
answering systems 202

For C-UL compliance 203

Mesures de sécurité
importantes 203

FCC Part 68 and ACTA 206

FCC Part 15 207

California Energy Commission
battery charging testing
instructions 208

Limited manufacturer's warranty 209

Technical specifications 211

DECT 6.0 digital technology 211

Telephone operating range 211

Redefining long range
coverage and clarity 211

HD audio 211

Simulated full-duplex handset
and base speakerphones 211

Index

Index 212

You must install and charge the battery before using the telephone.



STOP!

See page 12-14 for easy instructions.

Install the telephone base close to a telephone jack and a power outlet not controlled by a wall switch. The telephone base can be placed on a flat surface or vertically mounted on the wall (see page 16). For optimum range and better reception, place the telephone base in a central and open location.

If you subscribe to high-speed Internet service (DSL - digital subscriber line) through your telephone line, you must install a DSL filter between the telephone line cord and the telephone wall jack (see page 10). The filter prevents noise and caller ID problems caused by DSL interference. Please contact your DSL service provider for more information about DSL filters.

Your product may be shipped with protective stickers covering the handset and telephone base displays - remove them before use.

For customer service or product information, visit our website at **www.telephones.att.com** or call **1 (800) 222-3111**. In Canada, dial **1 (866) 288-4268**.

Avoid placing the telephone base and charger too close to:

- Communication devices such as television sets, VCRs, or other cordless telephones.
- Excessive heat sources.
- Noise sources such as a window with traffic outside, motors, microwave ovens, refrigerators, or fluorescent lighting.
- Excessive dust sources such as a workshop or garage.
- Excessive moisture.
- Extremely low temperature.
- Mechanical vibration or shock such as on top of a washing machine or workbench.

Quick reference guide - handset

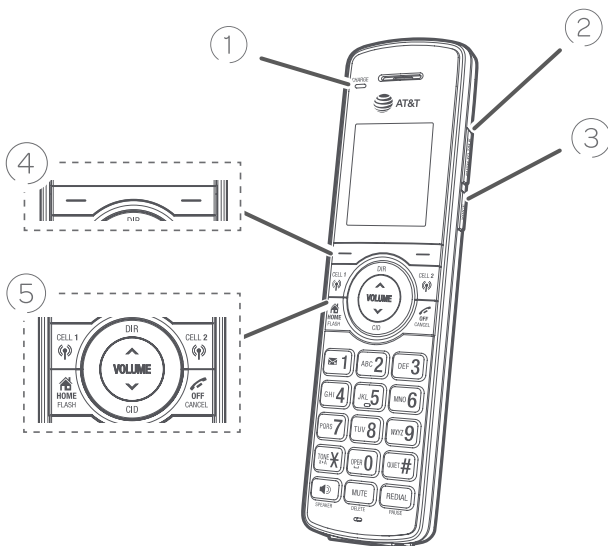

① CHARGE light

- ▶ On when the handset is charging in the telephone base or charger.

② PUSH TO TALK

- ▶ Press to initiate a one-to-one (page 79) or one-to-group broadcast (page 81).
- ▶ Press and hold to broadcast to a group of system devices (page 81).

③ VOICE

- ▶ Press to activate the voice-controlled application of connected cell phone (page 35).

④ Softkeys (2)

- ▶ Press to select the menu item displayed above the key (page 5).
- ▶ While in a menu, press to select an item, save an entry or setting, cancel an operation, or back up to the previous menu.

⑤ CELL 1 /CELL 2

- ▶ Press to make or answer a cell call (page 55).
- ▶ During a cell call, press to answer an incoming CELL 1/2 call when you hear a call waiting alert (page 56).
- ▶ During message playback, press to call back the caller if the caller's number is available (page 165).

HOME/FLASH

- ▶ Press to make or answer a home call (page 53).
- ▶ During a call, press to answer an incoming home call when you receive a call waiting alert (page 54).
- ▶ During message playback, press to call back the caller if the caller's number is available (page 165).

Quick reference guide - handset

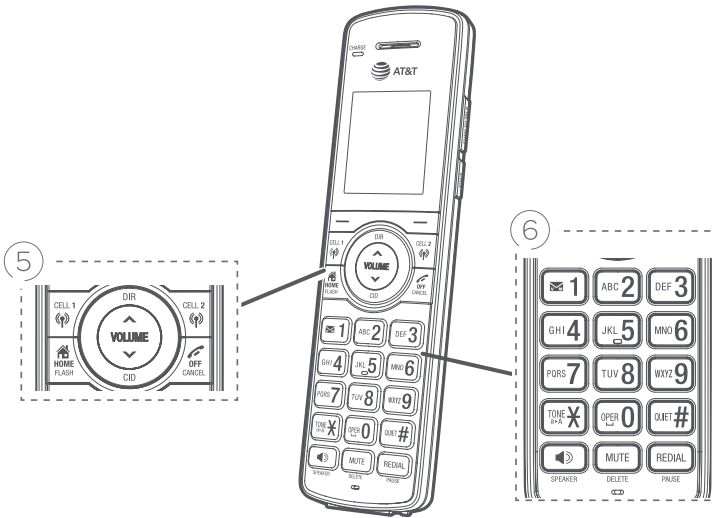

5 OFF/CANCEL

- ▶ During a call, press to hang up (page 53 or page 55).
- ▶ While in a menu, press to cancel an operation, back up to the previous menu, or exit the menu display; or press and hold this button to exit to idle mode.
- ▶ When the handset is ringing, press to mute the ringer temporarily (page 61).
- ▶ Press and hold while the telephone is not in use to erase the missed call indicator (page 98).

▲DIR/VOLUME

- ▶ Press ▲DIR to show directory entries when the handset is not in use (page 91).
- ▶ Press to scroll up while in menus.
- ▶ While entering names or numbers, press to move the cursor to the right.

- ▶ Press to increase the listening volume when on a call (page 60), or to increase the message playback volume (page 165).

▼CID/VOLUME

- ▶ Press ▼CID to show caller ID log when the handset is not in use (page 99).
- ▶ Press to scroll down while in menus.
- ▶ While entering names or numbers, press to move the cursor to the left.
- ▶ Press to decrease the listening volume when on a call (page 60), or to decrease the message playback volume (page 165).

6 1

- ▶ While reviewing a caller ID log entry, press repeatedly to add or remove 1 in front of the telephone number before dialing or saving it in the directory.
- ▶ Press and hold to set (page 44) or to dial your voicemail number.

Quick reference guide - handset

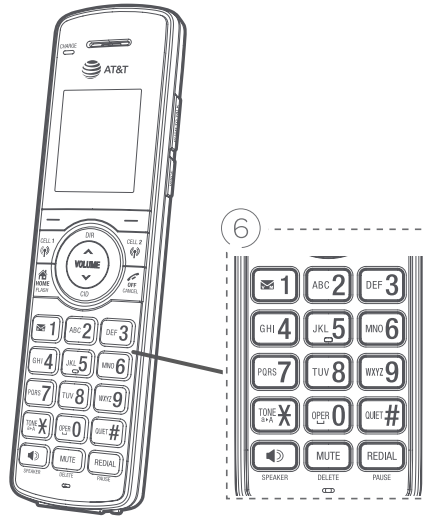

6 TONE*/a>A

- ▶ Press to switch to tone dialing temporarily during a call if you have pulse service (page 62).
- ▶ While entering names, press to change the next letter to upper or lower case.

QUIET# (pound key)

- ▶ Press repeatedly to display other dialing options when reviewing a caller ID log entry (page 100).
- ▶ Press and hold to enter the **QUIET** mode setting screen, or to deactivate **QUIET** mode (page 51).

🔊/SPEAKER

- ▶ Press to make or answer a home or cell call using the speakerphone (page 53 or page 55).
- ▶ Press to switch between the speakerphone and the handset (page 60).

MUTE/DELETE

- ▶ During a call, press to mute the microphone (page 61).
- ▶ When the handset is ringing, press to mute the ringer temporarily (page 61).
- ▶ While reviewing the caller ID log, the directory or the redial memory, press to delete an individual entry.
- ▶ While predialing, press to delete digits.
- ▶ During message or announcement playback, press to delete the playing message or the recorded announcement.

REDIAL/PAUSE

- ▶ Press repeatedly to view the last 10 numbers dialed (page 66).
- ▶ While entering numbers, press and hold to insert a dialing pause (page 87).

Quick reference guide - handset

Main menu

The selected menu item is highlighted.

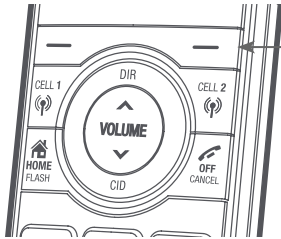

Feature menu

- Play messages (page 164)
- Answering sys (page 148)
- Smart call blk (page 108)
- Directory (page 86)
- Caller ID log (page 97)
- Intercom (page 73)
- Ringers (page 39)
- Set date/time (page 41)
- Caller ID annnc (page 43)
- Settings (page 42)

Using menus:

- Press **MENU** to show the menu.
- Press **▼CID** or **▲DIR** to scroll through menu items.
- Press **SELECT** to confirm or save changes to a highlighted menu item.
- Press **OFF/CANCEL** or **BACK** to cancel an operation, back up to the previous menu, or exit the menu display.

Quick reference guide - telephone base

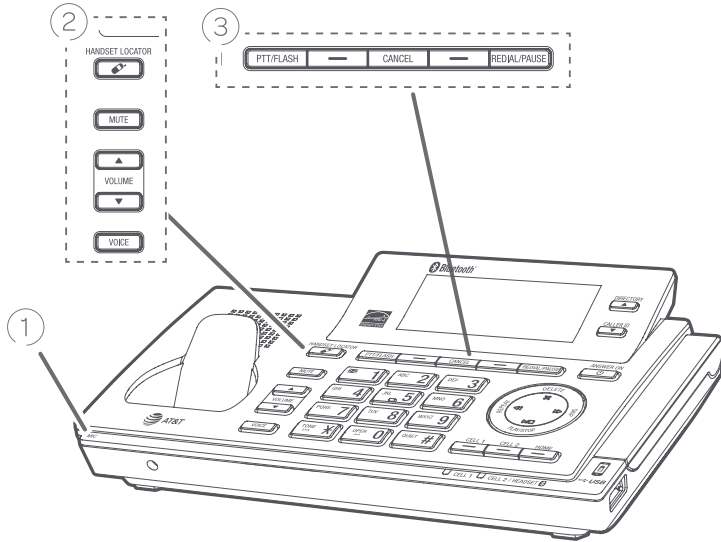

-
- ① **MIC**
- ▶ Microphone.

-
- ② **∅/HANDSET LOCATOR**
- ▶ Press the button to page all system handsets (page 71).

MUTE

- ▶ During a call, press to mute the microphone (page 61).
- ▶ While the telephone base is ringing, press to silence the ringer temporarily (page 61).

▼ VOLUME ▲

- ▶ Press to adjust the volume during message playback (page 165).
- ▶ Press to adjust the listening volume during a call (page 60).
- ▶ When the phone is not in use, press to adjust the telephone base ringer volume for all lines (page 60).

VOICE

- ▶ Press to activate the voice-controlled application of connected cell phone (page 35).

-
- ③ **PTT/FLASH**
- ▶ Press to display the PTT menu to begin a PTT call.
 - ▶ Press and hold to begin a one-to-group broadcast when the telephone base is not in use.
 - ▶ During a call, press to answer an incoming home call when you receive a call waiting alert (page 54).

Softkeys (2)

- ▶ Press to select the menu item displayed above the key.
- ▶ While in a menu, press to select an item, save an entry or setting, cancel an operation, or back up to the previous menu.

CANCEL

- ▶ While in a menu, press to exit without making changes or press and hold to return to idle mode.
- ▶ Press and hold while the telephone is not in use to erase the missed call indicator (page 98).

Quick reference guide - telephone base

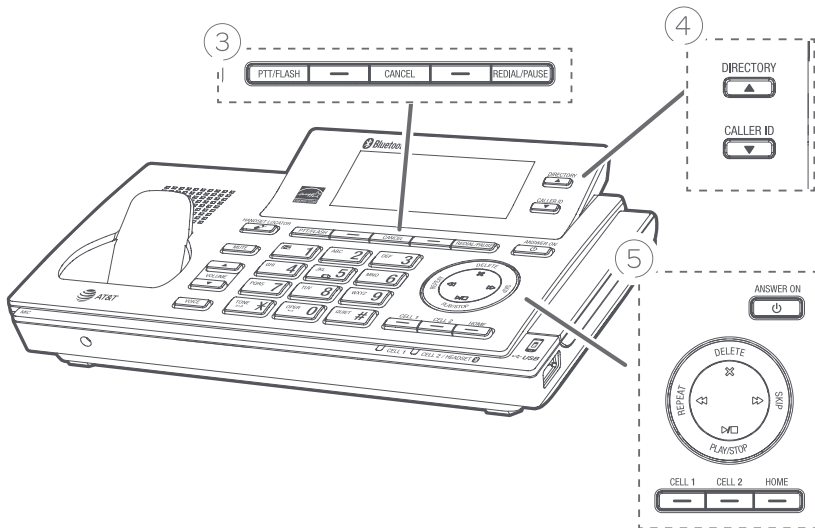

③ REDIAL/PAUSE

- ▶ Press repeatedly to view the last 10 numbers dialed (page 66).
- ▶ While entering numbers, press and hold to insert a dialing pause (page 87).

④ ▲ DIRECTORY

- ▶ Press to scroll up while in a menu.
- ▶ Press to show directory entries when the telephone is not in use (page 91).
- ▶ While entering names or numbers, press to move the cursor to the right.

▼ CALLER ID

- ▶ Press to scroll down while in a menu.
- ▶ Press to review the caller ID log when the telephone is not in use (page 99).
- ▶ While entering names or numbers, press to move the cursor to the left.

⑤ Ⓞ/ANSWER ON

Press to turn the answering system on or off (page 152).

X/DELETE

- ▶ Press to delete the message currently playing (page 165).
- ▶ When the phone is not in use, press twice to delete all previously reviewed messages (page 166).
- ▶ While reviewing the redial list, directory, caller ID log, allow list, block list, or star name list, press to delete an individual entry (pages 70, 95, 106, 127, 121 and 131).
- ▶ While entering names or numbers, press to delete a digit or a character.
- ▶ While predialing, press to delete a digits.

◀/REPEAT

- ▶ Press to repeat a message or press twice to play the previous message (page 165).

Quick reference guide - telephone base

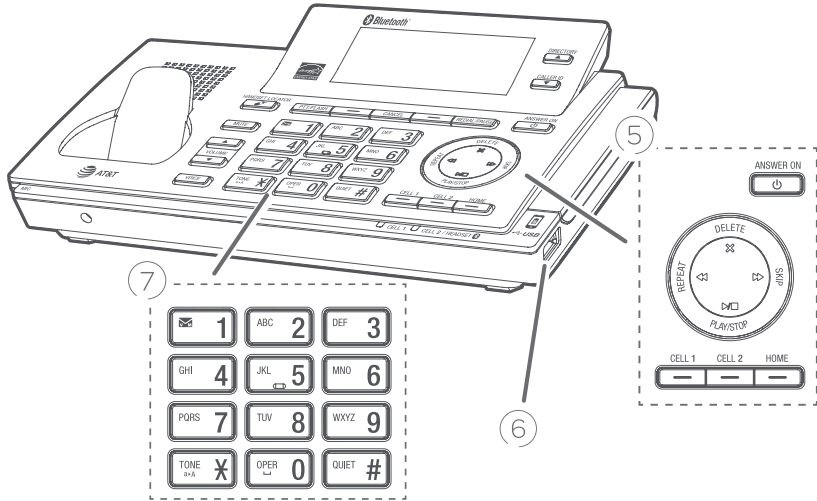

5 ►►/SKIP

- ▶ During message playback, press to skip to the next message (page 165).

►■/PLAY/STOP

- ▶ Press to play messages (page 164).
- ▶ Press to stop message playback (page 164).

CELL 1/CELL 2

- ▶ Press to make or answer a cell call (page 55).

HOME (Speakerphone)

- ▶ Press to make or answer a home call (page 53).
- ▶ Flashes quickly when there is an incoming home call.
- ▶ Flashes slowly when a home call is on hold.

6 USB port

- ▶ The standard size USB port in the telephone base is used for charging your cell phones.

7 1

- ▶ While reviewing a caller ID log entry, press repeatedly to add or remove **1** in front of the telephone number before dialing or saving it in the directory.
- ▶ Press and hold to set (page 44) or to dial your voicemail number.

TONE /a>A

- ▶ Press to switch to tone dialing temporarily during a call if you have pulse service (page 62).
- ▶ While entering names, press to change the next letter to upper or lower case.

QUIET# (pound key)

- ▶ Press repeatedly to display other dialing options when reviewing a caller ID log entry (page 100).
- ▶ Press and hold to enter the **QUIET** mode setting screen, or to deactivate **QUIET** mode (page 51).

Quick reference guide - telephone base

Main menu

The selected menu item is highlighted.

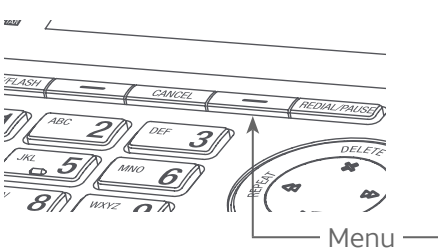

Feature menu

- Answering sys (page 148)
- Smart call blk (page 108)
- Directory (page 86)
- Caller ID log (page 97)
- Intercom (page 73)
- Bluetooth (page 22)
- Ringers (page 39)
- Set date/time (page 41)
- Caller ID annc (page 43)
- Settings (page 42)

Using menus:

- Press **MENU** in idle mode to show the main menu.
- Press **▼CALLER ID** or **▲DIRECTORY** to scroll through menu items.
- Press **SELECT** to confirm or save changes to a highlighted menu item.
- Press **CANCEL** or **BACK** to cancel an operation, back up to the previous menu, or exit the menu display.

Telephone base and charger installation

Install the telephone base and charger, as shown below.

The telephone base is ready for tabletop use. If you want to change to wall-mounting, see **Installation options** on page 16 for details.

Telephone base installation

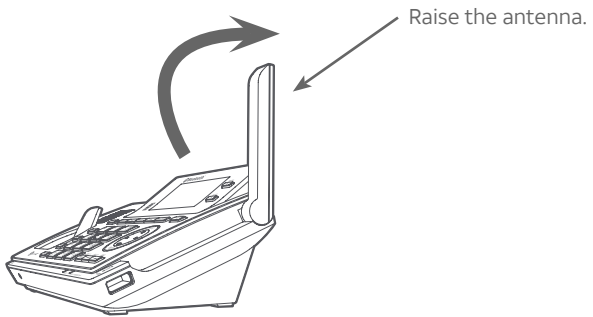
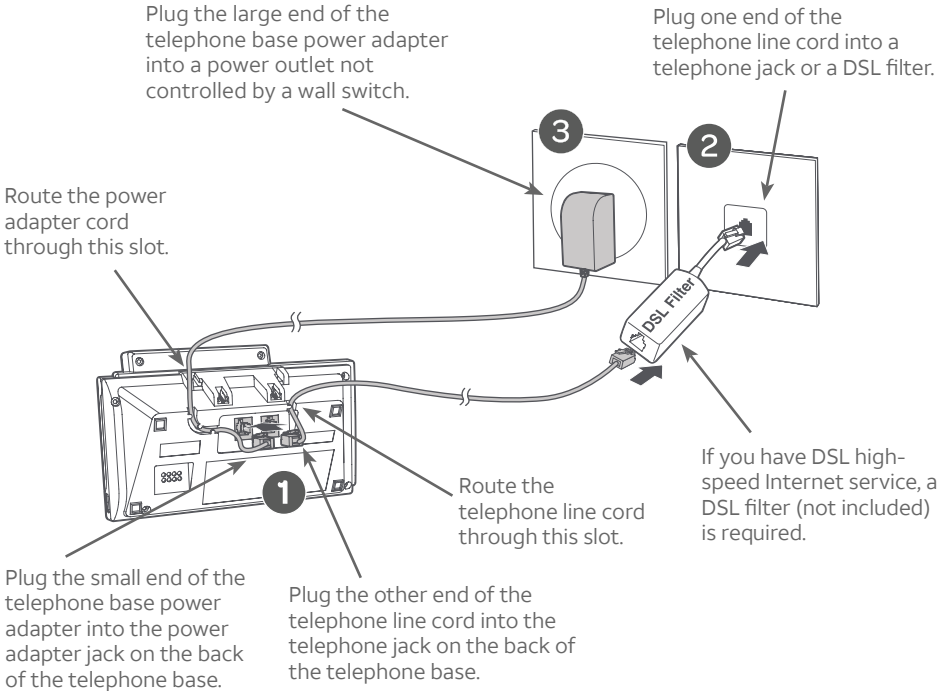

Telephone base and charger installation

Charger installation

Plug the power adapter into a power outlet not controlled by a wall switch.

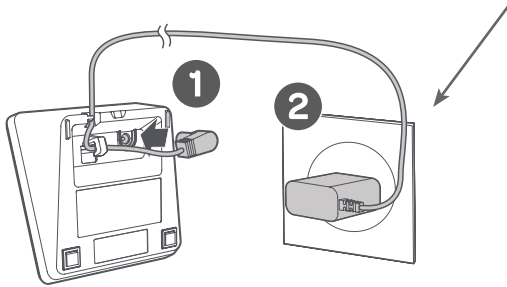



IMPORTANT INFORMATION

- Use only the power adapter(s) supplied with this product. To order a replacement power adapter, visit our website at **www.telephones.att.com** or call **1 (800) 222-3111**. In Canada, dial **1 (866) 288-4268**.
- The power adapters are intended to be correctly oriented in a vertical or floor mount position. The prongs are not designed to hold the plug in place if it is plugged into a ceiling, under-the-table or cabinet outlet.

Battery installation and charging

Install the battery, as shown below. Once you have installed the battery, the screen indicates the battery status (see the following table). If necessary, place the handset in the telephone base or charger to charge the battery. For best performance, keep the handset in the telephone base or charger when not in use. The battery is fully charged after 11 hours of continuous charging. See the table on page 211 for battery operating times.

If the screen shows **Place in charger** and  flashes, you need to charge the handset without interruption for at least 30 minutes to give the handset enough charge to use the telephone for a short time. The following table summarizes the battery charge indicators and actions to take.

Battery indicators	Battery status	Action
The screen is blank, or shows Place in charger and  (flashing).	Battery has no or very little charge. The handset cannot be used.	Charge without interruption (at least 30 minutes).
The screen shows Low battery and  (flashing).	Battery has enough charge to be used for a short time.	Charge without interruption (at least 30 minutes).
The screen shows HANDESET X .	Battery is charged.	To keep the battery charged, place it in the telephone base or charger when not in use.



Note: If you are on a phone call in low battery mode, you hear four short beeps every minute.

1. Plug the battery connector securely into the socket inside the handset battery compartment. Insert the supplied battery with the label **THIS SIDE UP** facing up, as indicated.

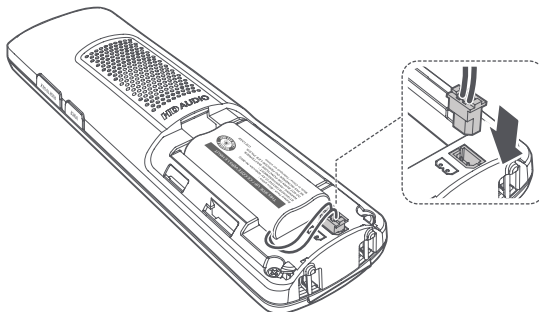

Battery installation and charging

2. Align the cover flat against the battery compartment, then slide it upwards until it clicks into place.

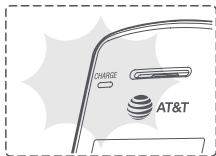
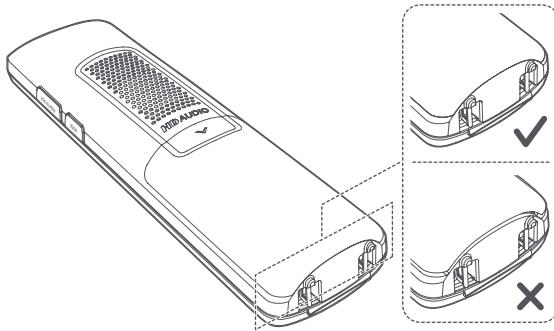
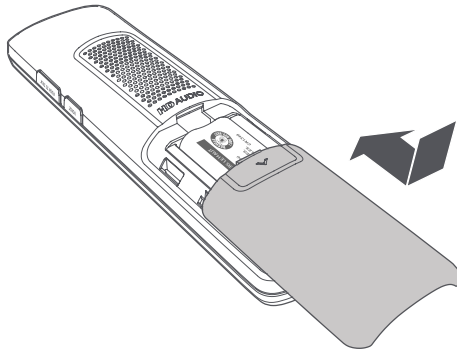

3. Charge the handset by placing it face forward in the telephone base or charger. The **CHARGE** light on the handset is on during charging.

Battery installation and charging

After you install your telephone or power returns following a power outage, the handset and telephone base will prompt you to set the date and time. For instructions, see **Set date/time** on page 41. To skip setting the date and time, press **OFF/CANCEL** on the handset or **CANCEL** on the telephone base.



After the date and time setting is done or skipped, the handset and the telephone base then prompts if you want to set Smart call blocker. Press **YES** on the handset or telephone base to start the Smart call blocker setup via voice guide. For more details, see **Voice guide to set Smart call blocker** on page 135. To skip the setup, press **NO**, or press **OFF/CANCEL** on the handset or **CANCEL** on the telephone base, and then press **OK**.



After the Smart call blocker setting is done or skipped, the handset and the telephone base will then prompt if you want to set up the answering system. Press **YES** on the handset or telephone base to start the answering system setup via voice guide. For more details, see **Voice guide to set Answering system** on page 154. To skip the setup, press **NO**, or press **OFF/CANCEL** on the handset or **CANCEL** on the telephone base.

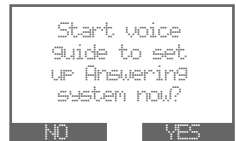
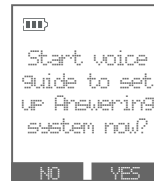

IMPORTANT INFORMATION

- Use only the supplied rechargeable battery or replacement battery (model BT183342/BT283342). To order, visit our website at **www.telephones.att.com** or call **1 (800) 222-3111**. In Canada, dial **1 (866) 288-4268**.
- If you do not use the handset for a long time, disconnect and remove the battery to prevent possible leakage.

Battery backup mode

Battery backup mode allows your telephone system to function in the event of a power outage. The telephone system uses stored power from the handset's battery to operate.

To activate the mode

After the power goes out, if there is already a handset with enough charge placed in the telephone base, the telephone system enters battery backup mode automatically. That handset screen shows **Powering base... Don't pick up**. All other handset screens show **Battery backup mode**.

-OR-

If there is no handset placed in the telephone base after the power goes out, all handsets show **Out of range OR no power at base** and **Put HS on base to power base**, alternately. Place any handset with enough charge in the telephone base. Its screen shows **Powering base... Don't pick up**. All other handset screens show **Battery backup mode**.



Note: A handset which does not have enough charge to power up the base, its screen shows **Out of range OR no power at base** and **Not enough battery to power base**, alternately, after the power goes out. Find another system handset that has enough charge to activate the mode.



Operation

During battery backup mode, the telephone base, answering system and all Bluetooth related features will be disabled. The operating time is subject to the battery level of the handset placed in the telephone base and the actual usage. For optimal performance, we recommend that you do not use the handset placed in the telephone base when this mode is on.

Using other system handsets (Recommended):

Operate the handsets the same way as usual, except the answering system and all Bluetooth related features which will be disabled.

Using the handset placed in the telephone base:

To maximize the operating time, you are not advised to use this handset. If you do have to use it, make sure you do not lift it from the telephone base. All operations should be done with the handset placed in the telephone base. In this case, calls can only be made and received using the speakerphone.

Installation options

Your telephone base is ready for tabletop use. If you want to mount your telephone on a wall, follow the steps mentioned below, to connect the telephone base with a standard dual-stud telephone wall-mounting plate. You may need a professional to install the mounting plate.

Tabletop to wall-mount installation

1. Plug the telephone line into the telephone base. If you are using a DSL filter, plug the other end of the telephone line into the filter. Route the telephone line cord (or DSL filter) through the wall-mount bracket hole.
2. Align the holes on the wall-mount bracket with the standard wall plate and slide the wall-mount bracket down until it locks securely.
3. Position the telephone base, as shown below. Insert the extended tabs (marked B) of the wall-mount bracket into the slots on the back of the telephone base. Push the telephone base down until it is securely in place.
4. Plug the power adapter into a power outlet not controlled by a wall switch. Plug the other end of the power adapter into the telephone base. Bundle the telephone line cord and power adapter cord neatly with twist ties.

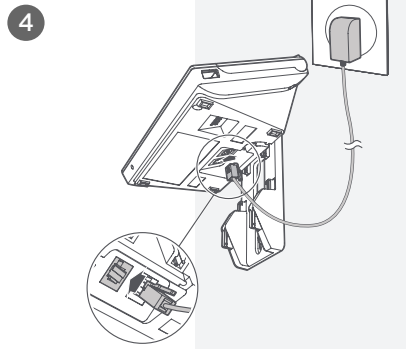
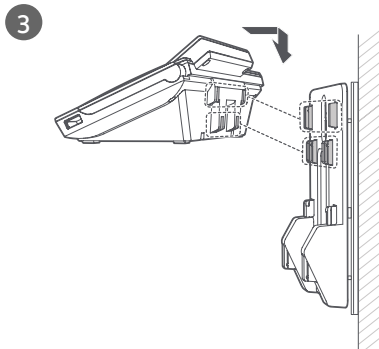
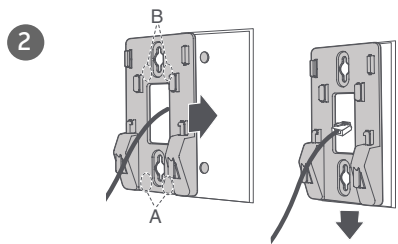
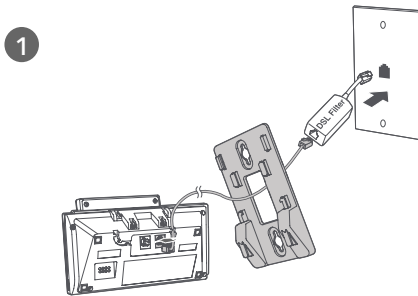

Installation options

Wall-mount to tabletop installation

1. Unplug the large end of the power adapter from the electrical outlet.
2. If the telephone line cord and power adapter cord are bundled, untie them first. Slide the wall-mount bracket up and remove it from the wall-mounting plate.

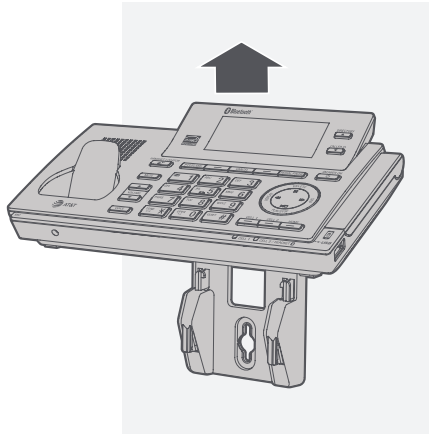

3. Unplug the telephone line cord or the DSL filter from the telephone wall jack. Push the telephone base up and away from the wall-mount bracket to detach it from the wall-mount bracket.

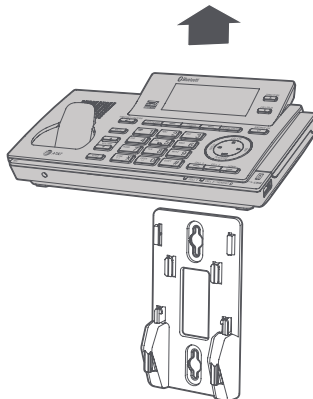

4. See **Telephone base and charger installation** on pages 10-11.

Introducing Bluetooth

Your new AT&T **CLP99287/CLP99387/CLP99447/CLP99457/CLP99487/CLP99547/CLP99557/CLP99587** telephone system with Bluetooth wireless technology has the following features:

- Pair up to 4 Bluetooth enabled devices (cell phones or headsets) with the telephone base.
- Connect a maximum of 2 Bluetooth enabled devices to make and receive cell calls. Both devices can be active on a call at a time.
- Connect a Bluetooth enabled headset for making and receiving home calls.
- Conference any combination of cell and home call.
- Make and receive calls using your cell phone service with your telephone base or system handsets.
- Download phonebook entries from your cell phone.
- Ringtone share feature allows you to set your telephone to play your iPhone® (iOS 4.1 or later) ringtone.

IMPORTANT INFORMATION

- After plugging in the telephone base, wait at least 20 seconds before connecting a Bluetooth device. The screen shows **Bluetooth system busy** if you try to connect too soon.
- Refer to the user's manual of your Bluetooth enabled cell phone or headset for more information about how that device uses Bluetooth connectivity.
- Bluetooth wireless technology operates within a short range (up to 30 feet) from the telephone base. Keep connected cell phones and headsets within this range.
- If your cell phone has poor reception in your home, the **CLP99287/CLP99387/CLP99447/CLP99457/CLP99487/CLP99547/CLP99557/CLP99587** cannot improve the reception. However, if there is a location in your house with better reception, you can leave your cell phone at that location while you use the **CLP99287/CLP99387/CLP99447/CLP99457/CLP99487/CLP99547/CLP99557/CLP99587** cell line. For optimal performance, the cell phone must be within 15 feet of the telephone base.

iPhone® is a registered trademark of Apple Inc.

IOS is a trademark or registered trademark of Cisco in the U.S. and other countries and is used under license.

Introducing Bluetooth

- ▶ If you experience poor sound quality, it may be caused by the distance between your cell phone and the telephone base. To improve the performance, place your cell phone closer to the telephone base (within 15 feet) and make sure that there are no physical obstacles such as large furniture or thick wall in between.

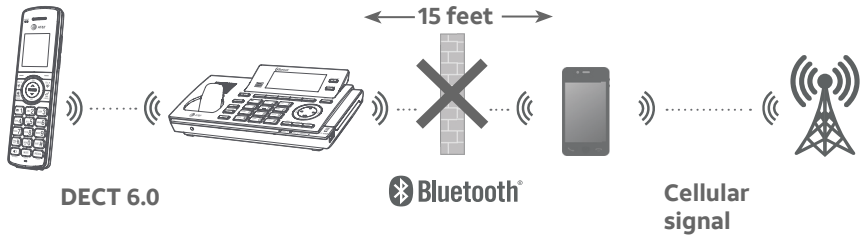

- ▶ Charge your cell phone while it is connected to the telephone base. Your cell phone's battery discharges faster while it is connected to the telephone base via Bluetooth wireless technology.
- ▶ Monitor your cell phone's usage because minutes may be deducted from your cellular plan for the duration of all cell calls, depending on the terms of your plan.

Refer to the **Bluetooth setup** section (pages 22-34) to learn how to set up your Bluetooth device. Refer to the **Telephone operation** section (pages 53-71) on how to operate your Bluetooth devices with your new AT&T **CLP99287/CLP99387/CLP99447/CLP99457/CLP99487/CLP99547/CLP99557/CLP99587** telephone system with Bluetooth wireless technology. Refer to the **Troubleshooting** section (pages 183-198) if you experience difficulty when using the telephone system.

The *Bluetooth*® word mark and logos are owned by Bluetooth SIG, Inc. and any use of such marks by Advanced American Telephones and its parent, VTech Holdings Limited, is under license. VTech Holdings Limited is a member of Bluetooth SIG, Inc. Other trademarks and trade names are those of their respective owners.

Introducing Bluetooth

Connect to Cell™ application

If you are using Bluetooth-enabled cell phones with Android® OS 2.3 or above, you can further extend the flexibility of your telephone system with use of the free **Connect to Cell** application.

Connect to Cell comprises **Caller ID manager** and **Alerts manager** that help integrate your cell phone with the AT&T telephone system.

Caller ID manager (Caller ID share) allows you:

- To view your AT&T phone's caller ID log on your Android cell phone;
- To use your Android cell phone to call back or send messages to individuals who have called your home line on the AT&T telephone;
- To store callers' names and numbers to your Android phone's directory for future use.

Alerts manager (Mobile notification) allows you to extend your Android phone's alerts to your AT&T telephone system. Your AT&T telephone will notify you whenever you receive certain text messages, e-mails or social media updates on your Android phone, so you will always be kept up to date.

To use **Caller ID manager** and **Alerts manager**, you must first download **Connect to Cell** to your Android cell phone using the **Google Play® Store** app. Scan the QR code on the right to download the application.







Glossary of terms

Below are some terms used in this user's manual to help you become familiar with using your Bluetooth devices and your new AT&T telephone system.



Active devices - the **Device list** has two active slots for two cell phones, or one cell phone and one headset. When a device in the list is active, it will have a **D1:** or **D2:** in front of the device name. In order to use a Bluetooth device on a call, it must be in an active slot and be connected.

Bluetooth cell phone - refers to a mobile Bluetooth enabled cellular telephone.

CELL line - the telephone line associated with your cell phone service. On your **CLP99287/CLP99387/CLP99447/CLP99457/CLP99487/CLP99547/CLP99557/CLP99587**, press **CELL 1**  or **CELL 2**  on the handset, or press **CELL 1** or **CELL 2** on telephone base to use the cell line.

Connected - when you pair a Bluetooth device to the **CLP99287/CLP99387/CLP99447/CLP99457/CLP99487/CLP99547/CLP99557/CLP99587**, it is placed in an active slot and automatically connected. When a device is connected, a **1** and/or **2** will display after  on the handset and telephone base screen. Also, the **CELL 1** and/or **CELL 2/HEADSET**  light on the telephone base will be on. If a device loses its connection to the telephone base, it must be reconnected before you can use the device with the telephone system.

Device list - The list of devices that have been paired to the telephone. You can pair up to 4 Bluetooth enabled devices (cell phones or headsets).

Disconnected - when a device is disconnected, **1** and/or **2** displays after  on the handset and telephone base screen. The **CELL 1** and/or **CELL 2/HEADSET**  light on the telephone base is/are off.

Discoverable mode - before a Bluetooth enabled device can be paired, it must be set to this mode. When pairing your cell phone, the telephone base is set to this mode. Depending on the cell phone manufacturer, this mode is sometimes referred to as **Find Me** or **Visibility**.

Paired devices - The Bluetooth enabled devices (cell phones or headsets) that have shared registration information with the telephone base. A total of four Bluetooth enabled devices can be paired to the telephone base. However, only two paired devices can communicate with the base at a time.

Pairing - sometimes referred to as **bonding**. The process of sharing registration information between two Bluetooth enabled devices. Your Bluetooth enabled cell phone or headset must first be paired to the telephone base in order to use it with this telephone system.

PIN - by default, the PIN is **0000** for the telephone base and for most Bluetooth devices. PIN information may be exchanged between Bluetooth devices before they can be used. This is also known as a **Passkey** or **Passcode**.

Bluetooth setup

To use a Bluetooth enabled cellular phone with your telephone, you must first pair and connect your Bluetooth cellular phone with the telephone base. Then, the **CLP99287/CLP99387/CLP99447/CLP99457/CLP99487/CLP99547/CLP99557/CLP99587** can be used to make or answer calls on the cell phone line.

Bluetooth wireless technology operates within a short range (up to 30 feet). When you pair a Bluetooth cell phone or Bluetooth headset to the telephone base, keep the device within 15 feet of the telephone base for optimal performance.

Add a cell phone

Before you begin, make sure that you have cellular coverage and your Bluetooth enabled cell phone is not connected to any other Bluetooth device. Refer to your cell phone user's manual to learn how to search for or add new Bluetooth devices.

To pair and connect a cell phone:

1. Press **MENU** on the telephone base in idle mode to enter the main menu.
2. Press **▼CALLER ID** or **▲DIRECTORY** to highlight **Bluetooth**, then press **SELECT**.
3. Press **SELECT** to choose **Add device**.
4. Press **SELECT** to choose **Add cellular**. The screen displays **Please wait...** followed by **1. If cell is connected to BT device, please disconnect it.**
 - If there are already 4 paired devices on the list, the 4th one on the list will be automatically removed, regardless of whether the pairing of the new device is successful or not.
 - If there are already 2 active devices on the list with prefix **D1:** or **D2:**, the telephone base shows **Cell Phone X is deactivated for adding a new device** (**Cell Phone X** represents the device name of the active cell phone).
5. Press **NEXT**. The screen displays **2. Place cell phone next to base.**
 - All devices that are connected to the telephone base are disconnected until the pairing process completes.

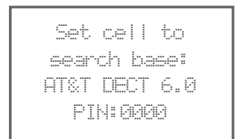

Bluetooth setup

6. Press **NEXT** to turn on the telephone base discoverable mode. The screen displays **Set cell to search base: AT&T DECT 6.0 PIN: 0000**. Promptly turn on the Bluetooth feature of your cell phone and search for or add new devices.
7. Once your cell phone finds your AT&T phone (**AT&T DECT 6.0**), press the appropriate key on your cell phone to continue the pairing process.
 - Your cell phone may require a passcode. In this case, the telephone base displays **Check cellular. ENTER PASS CODE**. Enter the cell phone passcode (typically **0000**) into the telephone base and press **SET**.
 - Enter the PIN of the telephone base (the default PIN is **0000**) into your cell phone to continue the pairing process, if required. The telephone base displays **Adding Cell Phone Y (Cell Phone Y** represents the device name of your cell phone).
8. When a device is successfully connected, the telephone base displays **Cell Phone Y is added and connected to base** and the corresponding status icon (📶1 or 📶2) displays (**Cell Phone Y** represents the device name of your cell phone). The corresponding device light on the telephone base (**CELL 1** or **CELL 2/HEADSET**📶) turns on.

If you have trouble pairing your cell phone, it may not be compatible with your CLP99287/CLP99387/CLP99447/CLP99457/CLP99487/CLP99547/CLP99557/CLP99587. Check the Bluetooth compatibility list at www.telephones.att.com/bluetooth.



Notes:

- The pairing process may take up to one minute. If the pairing process fails, try again.
- The steps for the pairing process may vary for different cell phones. If this happens, follow the prompts on your cell phone and your **CLP99287/CLP99387/CLP99447/CLP99457/CLP99487/CLP99547/CLP99557/CLP99587** to complete the pairing process.
- Refer to the user's manual of your cell phone on how to search for or add a new Bluetooth device.

Bluetooth setup

Add a headset

Before you begin, make sure that your Bluetooth enabled headset is not connected to any other Bluetooth device. Refer to your headset user's manual to learn how to search for or add new Bluetooth devices.

To pair and connect a headset:

1. Press **MENU** on the telephone base in idle mode to enter the main menu.
2. Press **▼CALLER ID** or **▲DIRECTORY** to highlight **Bluetooth**, then press **SELECT**.
3. Press **SELECT** to choose **Add device**.
4. Press **▼CALLER ID** or **▲DIRECTORY** to highlight **Add headset**, then press **SELECT**. The screen displays **If headset is connected to cell, please disconnect it.**
 - If there are already 4 paired devices on the device list, the 4th one on the list will be automatically removed, regardless of whether the pairing of the new device is successful or not.
 - If there is another headset already active, the screen will show **Only the BT headset in slot 2 can be ready for connection** and then **Headset X is deactivated for adding a new device** (**Headset X** represents the device name of the active Bluetooth headset).
5. Press **NEXT**. The screen displays **Pls set headset to discoverable mode**. Set your headset to discoverable mode (refer to the user's manual of your headset), then press **NEXT**.
 - All devices that are connected to the telephone base are temporarily disconnected.
6. The screen displays **Searching for Bluetooth headsets...**



Bluetooth setup

- When the screen displays the found devices, press **▼CALLER ID** or **▲DIRECTORY** to highlight your headset, if necessary, then press **SELECT**.
 - Enter the PIN of your headset, if required. The PIN for most Bluetooth devices is **0000** (refer to the user's manual of your headset), then press **NEXT**.
- The screen displays **Adding Headset Y** when the base is connecting to your headset (**Headset Y** represents the device name of your Bluetooth headset).
- When a device is successfully connected, the telephone base displays **Headset Y is added and connected to base** and the corresponding status icon **Ⓜ 2** (**Headset Y** represents the device name of your Bluetooth headset). You hear a confirmation tone. The corresponding light on the telephone base **CELL 2/HEADSETⓂ** turns on.



Adding
Headset Y

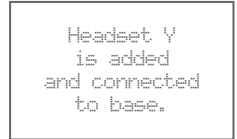

Headset Y
is added
and connected
to base.

If you have trouble pairing your headset, it may not be compatible with your CLP99287/CLP99387/CLP99447/CLP99457/CLP99487/CLP99547/CLP99557/CLP99587. Check the Bluetooth compatibility list at www.telephones.att.com/bluetooth.



Notes:

- The pairing process may take up to one minute. If the pairing process fails, try again.
- When a connected headset is charging, it may disconnect from the telephone base and the **CELL 2/HEADSETⓂ** light on the telephone base turns off. For some headset models, you may need to turn on the headset and reconnect it to the telephone base again.

Bluetooth setup

Auto connection

When an active device moves within Bluetooth range of the telephone base, or is turned on within range, the telephone base tries to connect to the device. When the device moves out of range, it is disconnected. Your device might make a connect or disconnect sound.

A connected device could also be disconnected by:

- ▶ Turning off the Bluetooth device.
- ▶ Turning off the Bluetooth feature of the device.
- ▶ Disconnecting through the telephone base **Device list**. If you disconnect through the **Device list**, the telephone base will not attempt to reconnect until your device is moved out of range and then moves back in range again.

Bluetooth connection from idle mode

When you have active devices that are not connected, **CONNECT** appears on the handset and telephone base in idle mode. Press **CONNECT** to start connecting an active device. When there are two active devices, the screen will prompt you to choose one before connection.

Device list and connection

Up to 4 devices can be paired to the telephone base. All paired devices are shown on the device list. To use a paired device, it must be in an active slot (**D1:** or **D2:**) on the device list and connected. Both Bluetooth enabled devices can be used on a cell call at a time.

Once you have paired a device with the telephone base, you do not need to repeat the pairing procedure again unless you delete the device from the device list.



Note: When connecting a Bluetooth device to the device list, all connected devices will be temporarily disconnected until the procedure completes. It may take up to 2 minutes to reconnect.

Bluetooth setup

Review the device list

1. Press **MENU** on the telephone base in idle mode.
2. Press **▼CALLER ID** or **▲DIRECTORY** to highlight **Bluetooth**, then press **SELECT**.
3. Press **▼CALLER ID** or **▲DIRECTORY** to highlight **Device list**, then press **SELECT**.

Connect/disconnect an active device

While in the device list menu, you may connect or disconnect your active device.

1. Press **MENU** on the telephone base in idle mode.
2. Press **▼CALLER ID** or **▲DIRECTORY** to highlight **Bluetooth**, then press **SELECT**.
3. Press **▼CALLER ID** or **▲DIRECTORY** to highlight **Device list**, then press **SELECT**.
4. Press **▼CALLER ID** or **▲DIRECTORY** to highlight a device, then press **OPTION**.
5. Press **▼CALLER ID** or **▲DIRECTORY** to highlight **Connect/Disconnect** (whichever is applicable), then press **SELECT**. The telephone base displays **Device connected/Device disconnected**. You hear a confirmation tone.



Note: When your active device is connected, you are prompted to select **Disconnect**. When your active device is disconnected, you are prompted to select **Connect**.

Bluetooth setup

Remove a paired device

When you already have a maximum of 4 devices on the device list and you want to add another device, you must first delete one from the list.

To remove a paired device:

1. Press **MENU** on the telephone base in idle mode to enter the main menu.
2. Press **▼CALLER ID** or **▲DIRECTORY** to highlight **Bluetooth**, then press **SELECT**.
3. Press **▼CALLER ID** or **▲DIRECTORY** to highlight **Device list**, then press **SELECT**.
4. Press **▼CALLER ID** or **▲DIRECTORY** to highlight the desired device, then press **X/DELETE**.

-OR-

- ▶ Press **▼CALLER ID** or **▲DIRECTORY** to highlight the desired device, then press **OPTION**.
 - ▶ Press **▼CALLER ID** or **▲DIRECTORY** to highlight **Remove**, then press **SELECT**.
5. The telephone base displays **Remove Headset X?** (**Headset X** represents the device name of your Bluetooth headset). Press **YES** to confirm. The telephone base displays **Device removed from device list** and you hear a confirmation tone.



Bluetooth setup

Replace an active device

If you already have 2 active devices on the device list and you want to activate a different device, you must deactivate one of the 2 active devices.

To replace an active device:

1. Press **MENU** on the telephone base when it is not in use.
2. Press **▼CALLER ID** or **▲DIRECTORY** to highlight **Bluetooth**, then press **SELECT**.
3. Press **▼CALLER ID** or **▲DIRECTORY** to highlight **Device list**, then press **SELECT**.
4. Press **▼CALLER ID** or **▲DIRECTORY** to highlight the device you want to activate without a **D1:** or **D2:** prefix, then press **OPTION**.
5. Press **▼CALLER ID** or **▲DIRECTORY** to highlight **Connect**, then press **SELECT**. The screen displays **Only BT devices in slot 1 or 2 can be ready for connection** and then a list of devices for deactivation.
6. Press **▼CALLER ID** or **▲DIRECTORY** to highlight the device to be deactivated, then press **NEXT**. The screen displays **Cell Phone X is deactivated**, and you hear a confirmation tone. The screen then displays **Connecting Cell Phone Y to the base... (Cell Phone X and Cell Phone Y represent the device names of your cell phones)**.
7. Depending on your cell phone settings, you may need to press a key on your cell phone to confirm the connection. When the new device is successfully activated and connected, the screen displays **Device connected**. You hear a confirmation tone.

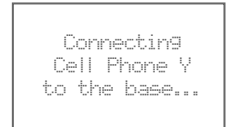
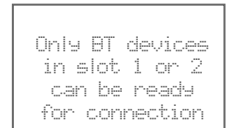

Note: When adding, removing, or replacing a Bluetooth device on the active devices list, all connected devices are temporarily disconnected until the procedure completes. It may take up to 2 minutes to reconnect.

Bluetooth setup

Download directory

You can download up to 4 cell phone directories (phonebooks) to your **CLP99287/CLP99387/CLP99447/CLP99457/CLP99487/CLP99547/CLP99557/CLP99587** telephone system via Bluetooth wireless technology. Each downloaded directory can store up to 1,500 entries with up to 30 digits for each phone number and 15 characters for each name.

Before downloading a directory, make sure the cell phone is paired, active, and connected to your telephone system.

Place your cell phone next to the telephone base when you download a cell phone directory to your telephone system.

To download a cell phone directory:

1. Press **MENU** on the telephone base in idle mode.
2. Press **▼CALLER ID** or **▲DIRECTORY** to highlight **Bluetooth**, then press **SELECT**.
3. Press **▼CALLER ID** or **▲DIRECTORY** to highlight **Download dir**, then press **SELECT**.
4. Press **▼CALLER ID** or **▲DIRECTORY** to highlight a device, then press **SELECT**.
5. Press **▼CALLER ID** or **▲DIRECTORY** to highlight one of the following options:
 - ▶ **Phone memory** - download all contacts stored in your phone memory.
 - ▶ **SIM card only** - download all contacts stored in your SIM card.
 - ▶ **Phone and SIM** - download all contacts stored in both your phone memory and SIM card.

Press **SELECT**. During the download, the telephone base displays the progress. All handsets display **Downloading....**



Bluetooth setup

- ▶ Your cell phone may require a passcode. In this case the screen displays **Check cellular. ENTER PASSCODE.** Enter the cell phone passcode into the telephone base and press **SET** to save.
- ▶ Your cell phone may require you to press a key to confirm the directory download.
- ▶ If the selected device's directory has already been downloaded to your telephone system, the telephone base displays the last update date of your cell phone. The directory stored on your telephone system for that cell phone will be erased and replaced with the current cell phone directory. If you have edited the downloaded entries (page 93), those changes will be lost. Press **NEXT** to start the download.
- ▶ If you already have 4 downloaded directories, the telephone base displays **Memory is full. Replace existing directory?** Press **YES**. Highlight the cell phone directory to be replaced and press **SELECT**. The screen displays **Replace Cell Phone X directory? (Cell Phone X represents the device name of your cell phone).** Press **YES** to confirm.



6. When the downloading process completes, the telephone base displays **Download ended XXXX entries saved.** (XXXX represents the total number of the downloaded entries). Press **OK** to return to the **Bluetooth** menu.



Notes:

- ▶ With certain cell phones, downloading from the SIM card is not supported. If this is the case, try transferring the contacts from your SIM card to your cell phone memory first, then download from your cell phone memory. For more information on how to transfer contacts from your SIM card to your cell phone memory, see your cell phone's user's manual.
- ▶ If **Phone memory** is chosen but with no entries saved, the telephone base displays **No entries found. Download from SIM only?** Press **YES** to confirm. If **SIM card only** is chosen but with no entries saved, the telephone base displays **No entries found. Download from Phone only?** Press **YES** to confirm. If **Phone and SIM** are chosen but with no entries saved in either or both directories, the telephone base displays **No entries found. Download from Phone only?** Press **YES** to confirm.
- ▶ When downloading the directory from your Bluetooth enabled cell phone, some data may not transfer. For example, if you have home, mobile and work numbers for a particular contact, the three category descriptions may not transfer to your **CLP99287/CLP99387/CLP99447/CLP99457/CLP99487/CLP99547/CLP99557/CLP99587**.

Bluetooth setup

Interruption to directory download

If you are downloading a directory from a cell phone and the phone receives a call, the download process stops and the telephone base displays **Download failed** and all the handsets display **Download fail** after the call ends. When you try to view the downloaded directory, the telephone base and handsets display **Last Download failed: MM/DD/YY**. You need to download the directory again (see page 30).

When you are downloading a directory from a cell phone and you wish to stop the download process, you may press **STOP**. The telephone base displays **Download directory cancelled**. The telephone base displays **Download failed** and all handsets display **Download fail** when the telephone returns to idle mode.



Note: During the download process, do not attempt to make changes to your cell phone directory.

Bluetooth setup

View the directory download information

1. Press **MENU** on the telephone base in idle mode to enter the main menu.
2. Press **▼CALLER ID** or **▲DIRECTORY** to highlight **Directory**, then press **SELECT**.
3. Press **▼CALLER ID** or **▲DIRECTORY** to choose the desired downloaded directory, then press **OPTION**.
4. Press **▼CALLER ID** or **▲DIRECTORY** to highlight **Last update**, then press **SELECT**.
 - The telephone base displays **Cell Phone X Last update MM/DD/YY Total #XXXX** (Cell Phone X represents the device name of your cell phone).
-OR-
 - The telephone base displays **Cell Phone X Last Download failed: MM/DD/YY** if there was an interruption during that directory download.
5. Press **OK** to exit.

```

Answering sys
Smart call blk
Directory
Caller ID log
BACK  ▲  SELECT
  
```

```

CELL PHONE X
Cell area code
Last update
Remove dir
BACK  ▲  SELECT
  
```

```

CELL PHONE X
Last update
09/30/15
Total #0159
OK
  
```



Note: If a handset tries to access the directory while a Bluetooth directory download is in progress, the screen shows **Not available at this time**.

Bluetooth setup

Change PIN

You are required to enter a PIN when establishing a Bluetooth connection. The default PIN of your telephone base is **0000**.

To change the PIN:

1. Press **MENU** on the telephone base in idle mode to enter the main menu.
2. Press **▼CALLER ID** or **▲DIRECTORY** to highlight **Bluetooth**, then press **SELECT**.
3. Press **▼CALLER ID** or **▲DIRECTORY** to highlight **Change PIN**, then press **SELECT**. The telephone base displays **ENTER NEW PIN** and the existing PIN.
4. Use the dialing keys to enter a new 4-digit code.
 - Press **X/DELETE** to erase a digit.
 - Press and hold **X/DELETE** to erase all digits.
 - Press **▼CALLER ID** or **▲DIRECTORY** to move the cursor to the left or right.
5. Press **SET** to save.



Cell ringer

If this feature is on and you have connected an iPhone device (iOS 4.1 or later) to your telephone system, the telephone plays your iPhone ringtone when there is incoming call.

1. Press **MENU** on the telephone base in idle mode to enter the main menu.
2. Press **▼CALLER ID** or **▲DIRECTORY** to highlight **Bluetooth**, then press **SELECT**.
3. Press **▼CALLER ID** or **▲DIRECTORY** to highlight **Cell ringer**, then press **SELECT**.
 - If there are more than one paired device on the device list, press **▼CALLER ID** or **▲DIRECTORY** to highlight the desired device, then press **SELECT**.
4. Press **▼CALLER ID** or **▲DIRECTORY** to choose **On** or **Off**, then press **SET**.



Note: The quality of ringtone played on your telephone is subject to individual ringtone characteristics.

Remote voice control

If you have connected a cell phone to the **CLP99287/CLP99387/CLP99447/CLP99457/CLP99487/CLP99547/CLP99557/CLP99587** telephone system, you can activate the voice-controlled application (voice app) of the cell phone, such as Siri®, Google Now™ or S Voice®, using your handset or telephone base.

The remote voice control feature works with:

Voice-controlled application	Siri	Google Now	S Voice
Operation System (Versions supported)	iOS (8 or above)	Android (4 or above)	Android (4 or above)

Before using the remote voice control feature, make sure you checked the following:

- ▶ Your cell phone is paired and connected to your telephone system via Bluetooth.
- ▶ No Bluetooth applications are running in the background of your cell phone.
- ▶ Keep your cell phone within 15 feet of the telephone base.
- ▶ Do not lock up your cell phone's screen or set passcode for activating the voice app.
- ▶ Make sure you have turned on or logged in to the applications on your cell phone that you will be sending your voice commands, such as GPS, e-mail and social networking accounts.
- ▶ Your cell phone's data or Wi-Fi signal is in full strength and your cell phone can connect to the Internet.
- ▶ Try to activate the voice app on your cell phone to ensure it is in place.

Siri® is a registered trademark of Apple Inc.

Google Now™ is a trademark of Google Inc.

S Voice® is a registered mark of Samsung Electronics Co., Ltd.

Remote voice control

Activate remote voice control

1. Press **VOICE** on the handset or telephone base.

- ▶ If you have connected two cell phones to the telephone, the telephone shows **Activate remote voice control of 1: Cell Phone X 2: Cell Phone Y** (Cell Phone X and Cell Phone Y represent the device names of your cell phones). Press **CELL 1** or **CELL 2**.

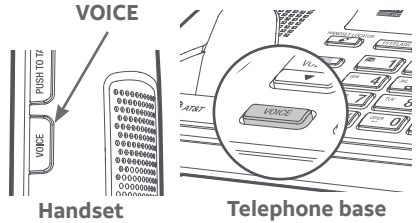

2. The telephone then shows **Activating remote voice control...**

- ▶ If the activation fails, the telephone displays **Connection timeout. Please check cell status..** Press **OK** and try again.

3. When the telephone base or handset plays the confirmation tone as forwarded by the cell phone's voice app, start speaking toward the telephone base or handset, and then wait for feedback. Make reply to the voice app's feedback, if necessary.

- ▶ You can press **🔊/SPEAKER** on the handset to turn off the speakerphone and listen to the feedback through the handset earpiece.

4. To end the current remote voice control session, press **END** on the telephone base or handset. You can restart by following Steps 1-3 mentioned above.

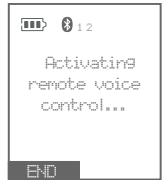
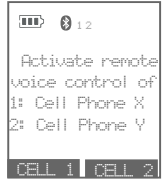

Remote voice control



Notes:

- ▶ Once you have activated the remote voice control feature, you are using your cell phone's voice app to operate your cell phone.
- ▶ Please check the cell phone user's manual and the voice app's help topics to find out what commands you can use and any limitations of the voice app.
- ▶ Some cell phone manufacturers or network carriers may customize the phone's operating system and implement their own voice app. If you want to use Google Now, you need to manually set it as your default voice app. For detailed instructions, refer to your cell phone user's manual, or contact your cell phone's manufacturer or network carrier. You may also go to "Google Product Forums" on the Internet and check the corresponding help topics.
- ▶ Due to the settings of certain cell phones and voice apps, your cell phone may not support the remote voice control feature. Contact your cell phone's manufacturer or network carrier, or check the voice app's help topics if you encounter any problems.
- ▶ During the remote voice control activation, if your Android cell phone comes with both a dedicated voice app and Google Now, it may prompt you to select which voice app to use, and whether use it for just once or always. Select the desired options. If you do not respond to your cell phone's prompt in time, the telephone displays **Connection timeout. Please check cell status.** Press **OK** and try again.
- ▶ If the cell phone is in use, the telephone displays **Bluetooth system busy**.
- ▶ If you receive a landline or cell line incoming call when you have activated remote voice control on a connected cell phone, the remote voice control operation will be ended.
- ▶ The feature may be ended automatically by your cell phone. For example, a cell call has been established via the remote voice control feature and the call has just ended.
- ▶ If you need to press dialing keys (**0-9, TONE*, QUIET#**) during a cell call, please make the call using the cell lines of your telephone system instead of using the voice app via the remote voice control feature (see **Make, answer or end a cell call** on page 55).

Handset and telephone base settings

Use the menu to change the cordless handset or telephone base settings.

1. Press **MENU** on the handset or telephone base when it is not in use to enter the main menu.
2. Press **▼CID** or **▲DIR** on the handset, or press **▼CALLER ID** or **▲DIRECTORY** on the telephone base to scroll to the feature to be changed. When scrolling through the menu, the selected menu item is highlighted.
3. Press **SELECT** to select the highlighted item.



Note: Press **OFF/CANCEL** on the handset, or press **CANCEL** on the telephone base to cancel an operation, back up to the previous menu or exit the menu display. Press and hold **OFF/CANCEL** on the handset, or press and hold **CANCEL** on the telephone base to return to idle mode.

Handset and telephone base settings

Ringer volume

You can set the ringer volume for incoming calls on all lines. A ringer off icon  shows when the volume is set to off.

1. Press **MENU** in idle mode to enter the main menu.
2. Press **▼CID** or **▲DIR** on the handset, or press **▼CALLER ID** or **▲DIRECTORY** on the telephone base to scroll to **Ringers**, then press **SELECT**.
3. Press **SELECT** again to select **Ringer volume**.
4. Press **▼CID** or **▲DIR** on the handset, or press **▼CALLER ID** or **▲DIRECTORY** on the telephone base to sample each volume level.
5. Press **SET** to save your preference. There is a confirmation tone and the screen returns to the previous menu.



-OR-

1. Press **▼VOLUME▲** on the telephone base to set the ringer volume of the telephone base while it is in idle mode.
2. Press **SET** to confirm and you hear a confirmation tone.



Notes:

- ▶ Changing the handset ringer volume does not affect the base ringer volume.
- ▶ If the ringer volume is set to off, that handset or the telephone base is silenced for all incoming calls.
- ▶ The ringer volume level also determines the ringer levels of intercom calls (page 73).
- ▶ If the ringer volume is set to off, the caller ID will not be announced and the screen will briefly display **Caller ID won't be announced**.

Handset and telephone base settings

Ringer tone

You can select the ringer tones for incoming home and cell calls.

To select a ringer tone:

1. Press **MENU** in idle mode to enter the main menu.
2. Press **▼CID** or **▲DIR** on the handset, or press **▼CALLER ID** or **▲DIRECTORY** on the telephone base to highlight **Ringers**, then press **SELECT**.
3. Press **▼CID** or **▲DIR** on the handset, or press **▼CALLER ID** or **▲DIRECTORY** on the telephone base to highlight **Ringer tone**, then press **SELECT**.
4. Press **▼CID** or **▲DIR** on the handset, or press **▼CALLER ID** or **▲DIRECTORY** on the telephone base to highlight **All lines**, **Home**, **Cell 1** or **Cell 2**, then press **SELECT**.
5. Press **▼CID** or **▲DIR** on the handset, or press **▼CALLER ID** or **▲DIRECTORY** on the telephone base to sample each ringer tone. A sample of each ringer tone plays as you scroll through the choices.
6. Press **SELECT** to select and save your choice. You hear a confirmation tone.



Note: If you turn off the ringer volume, you will not hear ringer tone samples.

Handset and telephone base settings

Set date/time

The answering system announces the day and time of each message prior to playing it. Before using the answering system, set the date and time as follows. If you subscribe to caller ID service, the day, month and time are set automatically with each incoming call. The year must be set so that the day of the week can be calculated from the caller ID information. You can turn off the date and time settings of the caller ID service and set the date and time manually (see **Use caller ID to automatically set date and time** on page 47).

After a power failure or handset registration, the system prompts you to set the date and time.

To set the date and time manually:

1. Press **MENU** in idle mode to enter the main menu.
2. Press **▼CID** or **▲DIR** on the handset, or press **▼CALLER ID** or **▲DIRECTORY** on the telephone base to scroll to **Set date/time** and then press **SELECT**.
3. Press **▼CID** or **▲DIR** on the handset, or press **▼CALLER ID** or **▲DIRECTORY** on the telephone base to select the month, then press **NEXT**, or enter the number using the dialing keys.
4. Press **▼CID** or **▲DIR** on the handset, or press **▼CALLER ID** or **▲DIRECTORY** on the telephone base to select the day, then press **NEXT**, or enter the number using the dialing keys.
5. Press **▼CID** or **▲DIR** on the handset, or press **▼CALLER ID** or **▲DIRECTORY** on the telephone base to select the year, or enter the number using the dialing keys, then press **NEXT** to move on to set the time.
6. Press **▼CID** or **▲DIR** on the handset, or press **▼CALLER ID** or **▲DIRECTORY** on the telephone base to select the hour, then press **SAVE**, or enter the number using the dialing keys.
7. Press **▼CID** or **▲DIR** on the handset, or press **▼CALLER ID** or **▲DIRECTORY** on the telephone base to select the minute, then press **SAVE**, or enter the number using the dialing keys.

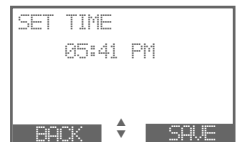

Handset and telephone base settings

- Press **▼CID** or **▲DIR** on the handset, or press **▼CALLER ID** or **▲DIRECTORY** on the telephone base to highlight **AM** or **PM**, or press **2** for **AM** or **7** for **PM**. Press **SAVE** to confirm. There is a confirmation tone and the screen returns to the previous menu.



Note: If the clock is not set when a message is recorded, the system announces, "Time and day not set," before it plays the message.

LCD language

You can select the language used for all screen displays.

- Press **MENU** in idle mode to enter the main menu.
- Press **▼CID** or **▲DIR** on the handset, or press **▼CALLER ID** or **▲DIRECTORY** on the telephone base to scroll to **Settings**, then press **SELECT**.
- Press **SELECT** to choose **LCD language**.
- Press **▼CID** or **▲DIR** on the handset, or press **▼CALLER ID** or **▲DIRECTORY** on the telephone base to highlight **English**, **Français** or **Español**, then press **SELECT**. The screen prompts **Set English/Français/Español as LCD language?**
- Press **YES** to save your preference. There is a confirmation tone and the screen returns to the previous menu. Press **NO** to cancel the operation.



Note: If you accidentally change the LCD language to French or Spanish, you can reset it back to English without going through the French or Spanish menus. Press **MENU** on the handset or telephone base in idle mode, then enter **364#**. Press **OFF/CANCEL** after the confirmation tone.

Handset and telephone base settings

Caller ID announce

The caller ID announce feature lets you know who's calling without having to look at the display. When you have an incoming call, the handset and/or base speaks "Call from..." and the name of the caller based on the directory or caller ID information. If the caller's name is private or unknown, the phone number up to the last 11 digits will be announced. If the caller's phone number is also private or unknown, no information will be announced. The default setting is **On**.

To turn on or off the caller ID announce feature:

1. Press **MENU** in idle mode to enter the main menu.
2. Press **▼CID** or **▲DIR** on the handset, or press **▼CALLER ID** or **▲DIRECTORY** on the telephone base to scroll to **Caller ID annc**, then press **SELECT**.
3. Press **▼CID** or **▲DIR** on the handset, or press **▼CALLER ID** or **▲DIRECTORY** on the telephone base to highlight **On** or **Off**, then press **SELECT**. There is a confirmation tone. The handset and telephone base screen show **CID Annc ON/OFF on all HS & BS** briefly before returning to the previous menu. The caller ID announce feature is turned on or off on all handsets and on the telephone base.



Notes:

- ▶ To use the caller ID announce feature, you must subscribe to caller ID service from your telephone service provider.
- ▶ If you have paired an AT&T **TL80133** DECT 6.0 cordless speakerphone to the telephone base, the caller ID announce setting for all devices also applies to the cordless speakerphone. When the setting is **On**, the cordless speakerphone speaks "Call from..." and the name of the caller based on the directory or caller ID information during an incoming call. If the caller's name is unavailable, the phone number up to the last 11 digits will be announced.
- ▶ When there are up to five handsets registered, the telephone system supports caller ID announce for all handsets. If six or more handsets are registered, the system supports caller ID announce for the first four registered handsets only.
- ▶ This feature does not announce information for call waiting calls.
- ▶ It takes at least 2 rings for the phone to receive caller ID information and announce it. If the phone is answered before the end of the second ring, the phone will not have time to announce the caller's information.
- ▶ Pronunciation of names may vary with this feature. Not all names may be pronounced correctly.
- ▶ When this feature is on, the telephone plays both the caller ID information and the ringer at the same time when there is an incoming call.
- ▶ Caller ID announce is available in English only.

Handset and telephone base settings

Set speed dial voicemail number

This feature lets you save your voicemail number for easy access when you press and hold the  **1** key.

To save your voicemail number:

1. Press **MENU** in idle mode to enter the main menu.
2. Press **▼CID** or **▲DIR** on the handset, or press **▼CALLER ID** or **▲DIRECTORY** on the telephone base to scroll to **Settings**, then press **SELECT**.
3. Press **▼CID** or **▲DIR** on the handset, or press **▼CALLER ID** or **▲DIRECTORY** on the telephone base to scroll to **Voicemail #**, then press **SELECT**.
4. Use the dialing keys to enter the voicemail access number provided by your telephone service provider (up to 30 digits) when prompted.
 - ▶ Press **▼CID** or **▲DIR** on the handset, or press **▼CALLER ID** or **▲DIRECTORY** on the telephone base to move the cursor to the left or right.
 - ▶ Press **MUTE/DELETE** on the handset, or press **X/DELETE** on the telephone base to erase a digit.
 - ▶ Press and hold **MUTE/DELETE** on the handset, or press and hold **X/DELETE** on the telephone base to erase all digits.
 - ▶ Press and hold **REDIAL/PAUSE** to enter a three-second dialing pause (a **p** appears).
5. Press **SAVE** to save. There is a confirmation tone and the screen displays **Voicemail # saved**, then returns to the previous menu.



Voicemail (visual message waiting) indicator

If you subscribe to a voicemail service offered by your telephone service provider, this feature provides a visual indication when you have new voicemail messages. **New voicemail** and  appear on the screens.



Notes:

- ▶ This feature does not indicate new messages recorded on your phone's built-in answering system.
- ▶ For more information about the difference between your answering system and voicemail, see page 160.

Handset and telephone base settings

Clear voicemail indication

Use this feature when the telephone indicates there is new voicemail but there is none. For example, when you have accessed your voicemail while away from home. This feature only turns off the displayed **New voicemail** and  icon; it does not delete your voicemail messages. As long as you have new voicemail messages, your telephone service provider continues to send the signal to turn on the indicators.

To manually turn off the new voicemail indicators:

1. Press **MENU** when in idle mode to enter the main menu.
2. Press **▼CID** or **▲DIR** on the handset, or press **▼CALLER ID** or **▲DIRECTORY** on the telephone base to scroll to **Settings**, then press **SELECT**.
3. Press **▼CID** or **▲DIR** on the handset, or press **▼CALLER ID** or **▲DIRECTORY** on the telephone base to scroll to **Clear voicemail**, then press **SELECT**. The screen shows **Reset Voicemail Indication?**
4. Press **YES** to turn the voicemail indication off. There is a confirmation tone and the screen returns to the previous menu.



Notes:

- ▶ Your telephone service provider voicemail may alert you to new messages with a stutter (broken) dial tone. Contact your telephone service provider for more details.
- ▶ For information about using your voicemail service, contact your telephone service provider.

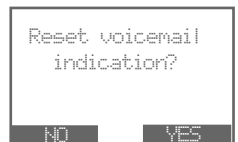

Handset and telephone base settings

Key tone

The handset is set to beep with each key press. You can adjust the key tone volume or turn it off. If you turn off the key tone, there are no beeps when you press keys.

1. Press **MENU** in idle mode to enter the main menu.
2. Press **▼CID** or **▲DIR** on the handset, or press **▼CALLER ID** or **▲DIRECTORY** on the telephone base to scroll to **Settings**, then press **SELECT**.
3. Press **▼CID** or **▲DIR** on the handset, or press **▼CALLER ID** or **▲DIRECTORY** on the telephone base to scroll to **Key tone**, then press **SELECT**.
4. Press **▼CID** or **▲DIR** on the handset, or press **▼CALLER ID** or **▲DIRECTORY** on the telephone base to select the desired volume or **Off**.
5. Press **SET** to save your preference. There is a confirmation tone and the screen returns to the previous menu.

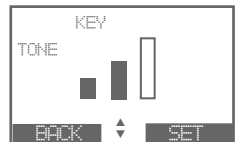
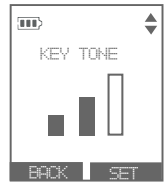

Handset and telephone base settings

Use caller ID to automatically set date and time

If you subscribe to caller ID service, the day, month and time are set automatically with each incoming call. Follow the steps mentioned below, to turn the **CID time sync** feature on or off. The default setting is **On**.

1. Press **MENU** in idle mode to enter the main menu.
2. Press **▼CID** or **▲DIR** on the handset, or press **▼CALLER ID** or **▲DIRECTORY** on the telephone base to scroll to **Settings**, then press **SELECT**.
3. Press **▼CID** or **▲DIR** on the handset, or press **▼CALLER ID** or **▲DIRECTORY** on the telephone base to scroll to **CID time sync**, then press **SELECT**.
4. Press **▼CID** or **▲DIR** on the handset, or press **▼CALLER ID** or **▲DIRECTORY** on the telephone base to highlight **On** or **Off**, then press **SELECT** to save. There is a confirmation tone and the screen returns to the previous menu.



Handset and telephone base settings

Home area code

If you dial seven digits to make a local call (no area code required), enter your area code into the telephone as the home area code. When you receive a call from within your home area code, the caller ID log only displays the seven digits of the telephone number.

This feature makes it easy for you to place a call from the caller ID log. If you dial ten digits to make a local phone call, do not use this home area code feature. If you do, you cannot place local calls from your caller ID log, as they will have only seven digits.

To set the home area code:

1. Press **MENU** in idle mode to enter the main menu.
2. Press **▼CID** or **▲DIR** on the handset, or press **▼CALLER ID** or **▲DIRECTORY** on the telephone base to scroll to **Directory**, then press **SELECT**.
3. Press **OPTION** to choose **Home**.



4. Press **▼CID** or **▲DIR** on the handset to scroll to **Home areacode**, then press **SELECT**. The screen briefly shows **Only for 7 digit dial from CID**.



-OR-

Press **▼CALLER ID** or **▲DIRECTORY** on the telephone base to scroll to **Home area code**, then press **SELECT**. The screen briefly shows **Only for 7 digits dialing from Caller ID log**.

5. Use the dialing keys to enter a three-digit home area code.
 - ▶ Press **MUTE/DELETE** on the handset, or **X/DELETE** on the telephone base to erase a digit.
 - ▶ Press and hold **MUTE/DELETE** on the handset, or **X/DELETE** on the telephone base to erase all digits.
6. Press **SAVE** to confirm. There is a confirmation tone. The handset screen shows **Areacode will not show in CID** and the telephone base screen shows **Area code will not show in Caller ID log** briefly before returning to the previous menu.



Note: If in the future, your telephone service provider requires you to dial ten digits to make a local call (area code plus telephone number), you need to delete your home area code. With the home area code displayed, press and hold **MUTE/DELETE** on the handset or press and hold **X/DELETE** on the telephone base until the digits are deleted, and then press **SAVE**. The home area code is now restored to its default setting of --- (empty).

Handset and telephone base settings

Cell area code

Most cell phone entries are stored in a 10-digit format. If all of your cell phone entries are stored this way, you do not need to program your cell area code.

If your cell phone stores entries in a 7-digit format, we recommend that you program your cell area code so that your 7-digit directory entries can be dialed correctly using your home line.

To set the cell area code:

1. Press **MENU** in idle mode to enter the main menu.
2. Press **▼CID** or **▲DIR** on the handset, or press **▼CALLER ID** or **▲DIRECTORY** on the telephone base to highlight **Directory**, then press **SELECT**.
3. Press **▼CID** or **▲DIR** on the handset, or press **▼CALLER ID** or **▲DIRECTORY** on the telephone base to highlight the desired downloaded directory, then press **OPTION**.
4. Press **▼CID** or **▲DIR** on the handset to scroll to **Cell areacode**, then press **SELECT**. The screen briefly shows **Only for 7 digit dial from CID**.

-OR-

Press **▼CALLER ID** or **▲DIRECTORY** on the telephone base to scroll to **Cell area code**, then press **SELECT**. The screen briefly shows **Only for 7 digits dialing from Caller ID log**.

5. Use the dialing keys to enter the desired cell area code.
 - Press **MUTE/DELETE** on the handset, or **X/DELETE** on the telephone base to erase a digit.
 - Press and hold **MUTE/DELETE** on the handset, or **X/DELETE** on the telephone base to erase all digits.
6. Press **SAVE** to confirm. There is a confirmation tone. The handset screen shows **Areacode will not show in CID** and the telephone base screen shows **Area code will not show in Caller ID log** briefly before returning to the previous menu.



Handset and telephone base settings

Dial mode

The dial mode is preset to tone dialing. If you have pulse (rotary) service, you must change the dial mode to pulse dialing before using the telephone.

To set the dial mode:

1. Press **MENU** in idle mode to enter the main menu.
2. Press **▼CID** or **▲DIR** on the handset, or press **▼CALLER ID** or **▲DIRECTORY** on the telephone base to scroll to **Settings**, then press **SELECT**.
3. Press **▼CID** or **▲DIR** on the handset, or press **▼CALLER ID** or **▲DIRECTORY** on the telephone base to scroll to **Dial mode**, then press **SELECT**.
4. Press **▼CID** or **▲DIR** on the handset, or press **▼CALLER ID** or **▲DIRECTORY** on the telephone base to highlight **Touch-tone** or **Pulse**, then press **SELECT**. There is a confirmation tone and the screen returns to the previous menu.

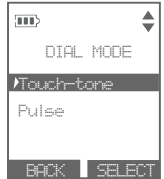

Handset and telephone base settings

QUIET mode

When **QUIET** mode is turned on, the telephone silences all sounds during the set period of time (1-12 hours). However, the handset locator paging tone and any sound-generating operations initiated by users, such as making calls using the speakerphone or setting ringer volume, will sound as normal. After you turn on **QUIET** mode, this feature activates immediately and the answering system turns on automatically.

When **QUIET** mode is on, the answering system takes calls and records messages without broadcasting them.

To turn QUIET mode on:

1. Press and hold QUIET # in idle mode to enter the **QUIET** mode setting screen. The screen shows **Set quiet mode duration (1 to 12 hours) _ _**.
2. Use the dialing keys to enter the desired number of hours (1-12) you would like to turn on **QUIET** mode, then press **SELECT**. Your screen briefly shows **Answering sys is ON during quiet mode** and then **Quiet mode on** in the idle screen.

To turn QUIET mode off:

- ▶ While **QUIET** mode is on, press and hold QUIET #. The screen shows **Quiet mode is off** and you hear a confirmation tone.



Notes:

- ▶ If you change the base ringer, handset ringer, ringer volume, key tone, or caller ID announce features when **QUIET** mode is on, the sample plays but the feature is still muted after saving the setting.
- ▶ After **QUIET** mode is turned off or the set period of time has expired, all muted features will be activated again.
- ▶ The PTT function is not available when **QUIET** mode is on.
- ▶ When **QUIET** mode is on, and Smart call blocker is on and in screening mode, all screened home calls will be sent to the answering system after screening. For more information on Smart call blocker, see page 108.

Handset and telephone base settings

No line alert

If there is no telephone line connected to the telephone base, the screens show **No home line**. If you do not want to display this message on the screens (for example, if you use the cell line only), you can turn the no line alert off using the code, as described below.

To turn off the no line alert:

Press **MENU** on the handset or telephone base in idle mode, then enter ***662#**. You hear a confirmation tone.

To turn the no line alert back on:

Press **MENU** on the handset or telephone base in idle mode, then enter ***661#**. You hear a confirmation tone.

Cell alert

If you have downloaded the **Connect to Cell** application and use the **Alerts manager** (page 20), there are message notifications sent to your telephone system. Your telephone system beeps once when your Android cell phone receives text messages, e-mails or social media updates. You can turn the alert tone on or off using the code, as described below.

To turn the alert tone off:

Press **MENU** on the handset or telephone base, then enter ***252#**. You hear a confirmation tone.

To turn the alert tone back on:

Press **MENU** on the handset or telephone base, then enter ***251#**. You hear a confirmation tone.

Make, answer and end a call

Make, answer or end a home call

Using a cordless handset:

To make a home call:

- ▶ Press **HOME/FLASH** or **SPEAKER**, then enter the telephone number.

To predial a home call:

- ▶ Enter the telephone number, then press **HOME/FLASH** or **SPEAKER**.

To answer a home call:

- ▶ Press **HOME/FLASH** or **SPEAKER**, **CELL 1**, **CELL 2** or any dialing key (**0-9** or **TONEX**).

To end a home call:

Press **OFF/CANCEL**, or put the handset in the telephone base or charger.



Notes:

- ▶ The screen shows the elapsed time as you talk (in hours, minutes and seconds).
- ▶ When predialing (preview numbers before dialing), press **MUTE/DELETE** to backspace and delete; press and hold **REDIAL/PAUSE** to insert a dialing pause (a **p** appears).
- ▶ You cannot answer a home call using your connected cell phone.

Using the telephone base:

To make a home call:

- ▶ Press **HOME** on the telephone base, then enter the telephone number.

To predial a home call:

- ▶ Enter the telephone number, then press **HOME**.

To answer a home call:

- ▶ Press **HOME**, **CELL 1**, **CELL 2** or any dialing key (**0-9** or **TONEX**).

To end a call a home call:

- ▶ Press **HOME**.



Notes:

- ▶ The screen shows the elapsed time as you talk (in hours, minutes and seconds).
- ▶ When predialing (preview numbers before dialing), press **X/DELETE** to backspace and delete; press and hold **REDIAL/PAUSE** to insert a dialing pause (a **p** appears).

Make, answer and end a call

Using a Bluetooth headset:

You can use a Bluetooth headset for home calls. However, you need to keep the device within 15 feet of the telephone base for optimal performance. Please see the user's manual of your Bluetooth headset for more information.

To answer a home call using a Bluetooth headset:

- ▶ Press the call key on your headset.

To end a home call using a Bluetooth headset:

- ▶ Press the call key on your headset.

To transfer a call from the telephone base to a Bluetooth headset:

- ▶ Press **OPTION** on the telephone base, then press **▼CALLER ID** or **▲DIRECTORY** to highlight **Use BT Headset** and then press **SELECT**. The telephone base displays **Transferring audio to Headset A**.

Call waiting on the home line

If you subscribe to call waiting service from your telephone service provider, and someone calls while you are already on a call, you hear a tone.

- ▶ Press **HOME/FLASH** on the handset, or press **PTT/FLASH** on the telephone base to put your current call on hold and take the new call.



Notes:

- ▶ If the Smart call blocker feature is on and in screening mode, and you receive a call waiting home call:
 - If you have already picked up a screened home call, the telephone checks whether the call waiting call's number can be found in the directory, block list or allow list. It also checks whether the caller name is in the star name list. After that, the telephone displays the caller ID information or **Blocked call** accordingly. You can press **HOME/FLASH** or **▶/SPEAKER** to take the new call.
 - If the telephone is screening a home call, the call waiting call will be ignored and logged as missed call in the caller ID log.
- ▶ The screening feature of Smart call blocker is applicable to home calls only:

Make, answer and end a call

Make, answer or end a cell call

The **CLP99287/CLP99387/CLP99447/CLP99457/CLP99487/CLP99547/CLP99557/CLP99587** can be used to make or answer calls on the cell line. You can connect a maximum of 4 Bluetooth enabled cell phones to the telephone base. Both cell phones can be used on cell calls at the same time.

Using a cordless handset:

To make a cell call:

- Press **CELL 1** or **CELL 2**. Enter the telephone number, then press **DIAL**.

To predial a cell call:

- Enter the telephone number, then press **CELL 1** or **CELL 2**.

To answer a cell call:

- Press **HOME/FLASH** or **SPEAKER**, **CELL 1**, **CELL 2** or any dialing key (**0-9** or **TONEX**).

To end a cell call:

Press **OFF/CANCEL**, or put the handset in the telephone base or charger.

Using the telephone base:

To make a cell call:

- Press **CELL 1** or **CELL 2**, then enter the telephone number.
- Press **DIAL**.

To predial a cell call:

- Enter the telephone number, then press **CELL 1** or **CELL 2**.

To answer a cell call:

- Press **HOME**, **CELL 1**, **CELL 2** or any dialing key (**0-9** or **TONEX**).

To end a cell call:

- Press **CELL 1** or **CELL 2**.



Notes:

- You can also use your cell phone to answer the call. If you answer with your cell phone, it disconnects from the telephone base.
- If you do not want to answer the call, press **REJECT**.

Make, answer and end a call

- ▶ When you try to make a cell call but your cell phone is not connected to the base, the telephone base displays **Cellular phone not connected. Please connect to proceed.** Press **CONNECT** to connect your cell phone to the telephone system. Refer to **Bluetooth connection from idle mode** on page 26 and **Connect/disconnect an active device** on page 27.
- ▶ Make a cell call using the cell lines of your telephone system instead of the remote voice control feature, if you need to press dialing keys (**0-9, TONE*, QUIET#**) during a call.

Call waiting on the cell line

If you subscribe to call waiting service from your cell phone service provider, and someone calls while you are already on a call, you hear a beep.

Using a cordless handset:

- ▶ Press **CELL 1** (📞) or **CELL 2** (📞) to put your current call on hold and take the new call.
- ▶ Press **CELL 1** (📞) or **CELL 2** (📞) at any time to switch back and forth between calls.

-OR-

Press **SWAP** to switch. To switch back, press **CELL 1** (📞) or **CELL 2** (📞).

Using the telephone base:

- ▶ Press **SWAP** on the telephone base. The original call is put on hold and you take the new call.
- ▶ Press **OPTION** on the telephone base. Press **▼CALLER ID** or **▲DIRECTORY** to highlight **Swap Cell X**. Press **SELECT** to resume the original call. The other incoming cell call is put on hold.





Notes:

- ▶ If the Smart call blocker feature is on and in screening mode, and you receive a call waiting cell call:
 - If you have already picked up a screened home call, the telephone checks whether the call waiting cell call's number can be found in the block list. If yes, the telephone displays **Blocked call** and rejects the call.
- ▶ The screening feature of Smart call blocker is applicable to home calls only:



Make, answer and end a call

Answer an incoming cell call while on a home call

If you are on a home call and you receive an incoming cell call, you hear a beep and  1 or  2 displays on the handset or telephone base you are using. The telephone base and all other handsets ring.

To answer the incoming cell call:

Using a cordless handset or the telephone base:

- Press **CELL 1**  or **CELL 2**  on the handset. The home call is automatically placed on hold; all other handsets and the telephone base display **Home call on hold** and **Cell 1/2 line in use**, alternately.

To end the cell call:

Using a cordless handset:

- Press  **OFF/CANCEL** on the handset. The home line is still on hold. The telephone base and all other handsets display **Home call on hold**.

Using the telephone base:

- Press **CELL 1** or **CELL 2** on the telephone base. The home line is still on hold. All handsets display **Home call on hold**.

To resume the home call on hold:

Using a cordless handset:

- Press  **HOME/FLASH** on the handset.

Using the telephone base:

- Press **HOME** on the telephone base.

Make, answer and end a call

Answer a home call while on a cell call

If you are on a cell call and you receive an incoming home call, you hear a beep and  displays on the handset or telephone base you are using. The telephone base and all other handsets ring.

To answer the incoming home call:

Using a cordless handset:

- Press  **HOME/FLASH** on the handset. The cell call is automatically placed on hold and the telephone base displays **Cell 1/2 call on hold** and **Home line in use**, alternately.

Using the telephone base:

- Press **HOME** on the telephone base. The cell call is automatically placed on hold. All handsets display **Cell 1/2 call on hold** and **Home line in use**, alternately.

To end the home call:

Using a cordless handset:

- Press  **OFF/CANCEL** on the handset. The cell line is still on hold. The telephone base and all handsets display **Cell 1/2 call on hold**.

Using the telephone base:

- Press **HOME** on the telephone base. The cell line is still on hold. The telephone base and all handsets display **Cell 1/2 call on hold**.

To resume the cell call on hold:

Using a cordless handset:

- Press **CELL 1**  or **CELL 2**  on the handset.

Using the telephone base:

- Press **CELL 1** or **CELL 2** on the telephone base.



Note: If you have turned on your answering system and you do not answer the incoming home call, the call is answered by your answering system.

Conference calls

Conference home and cell calls

When you have calls established on the home and cell lines, you can create a 3-way conference.

To conference both home and cell calls:

1. Press **OPTION** on the handset or telephone base.
2. Press **▼CID** or **▲DIR** on the handset, or press **▼CALLER ID** or **▲DIRECTORY** on the telephone base to highlight **Conference**.
3. Press **SELECT**. The conferencing device's screen displays **Conf**.

To select an option while on a conference call:

1. Press **OPTION** on the handset or telephone base.
2. Press **▼CID** or **▲DIR** on the handset, or press **▼CALLER ID** or **▲DIRECTORY** on the telephone base to highlight one of the following options:
 - **Hold**
 - **End Home line**
 - **End Cell 1/2 line**
 - **Equalizer**
 - **Caller ID log**
 - **Directory**
3. Press **SELECT**.

To end a conference call:

- Press **OFF/CANCEL** on the handset or **HOME** on the telephone base. You can also put the handset back in the telephone base or charger.

Using the home and cell lines together:

- You can be on two different calls at the same time using the cell line and home line with two handsets.
- You can be on a call using the cell line and a Bluetooth headset via the home line at the same time.
- If you are on a call using the cell line, you cannot join the call using your paired cell phone. However, you can join the call using another **CLP99287/CLP99387/CLP99447/CLP99457/CLP99487/CLP99547/CLP99557/CLP99587** device. Your cell phone is being used for the phone call so only features that are normally available during a call can be used.
- Press the same key at any time to switch back and forth between calls.

Options while on calls

Handset speakerphone

During a call, press **☎/SPEAKER** on the handset to switch between the speakerphone and normal handset use. In speakerphone mode, press **🔇 OFF/CANCEL** or return the handset to the telephone base or charger to hang up.

Volume control

While on a call, you can adjust the listening volume on the handset or telephone base.

If it is a cell call and the volume is too loud, too quiet or drops out, try changing the volume on your cell phone. On some cell phones, changing the volume on the cell phone affects your cell call volume on the **CLP99287/CLP99387/CLP99447/CLP99457/CLP99487/CLP99547/CLP99557/CLP99587** handsets or telephone base.

To adjust the listening volume of a handset:

- Press **▼ VOLUME ▲** on the handset while on a call.

To adjust the listening volume of the telephone base:

- Press **▼ VOLUME ▲** on the telephone base while on a call.



Note: The handset earpiece volume setting (1-6) and speakerphone volume setting (1-6) are independent. The speakerphone volume setting of the telephone base (1-8) is also independent.

Options while on calls

Silence the ringer

When the telephone is ringing, you can temporarily silence the ringer of the handset or telephone base without disconnecting the call. The next call rings normally at the preset volume.

To silence the handset ringer:

- Press **MUTE**,  **OFF/CANCEL**, **MUTE/DELETE** or **QUIET #** on the handset. The handset screen shows **Ringer muted**.

To silence the base ringer:

- Press **MUTE**, **MUTE**, **CANCEL** or **QUIET #**.

The telephone base displays **Ringer muted**.

Mute

Use the mute function to turn off the microphone. You can hear the caller, but the caller cannot hear you.

Using a cordless handset:

To mute a call:

- While on a call, press **MUTE/DELETE**. When mute is on, the handset shows **Muted** for a few seconds and **MUTE** icon displays until you turn off mute.

To end mute a call:

- Press **MUTE/DELETE** again. When mute is off, **Microphone ON** appears temporarily on the handset.

Using the telephone base:

To mute a call:

- While on a call, press **MUTE**. When mute is on, the **MUTE** light turns on. The telephone base shows **Muted** for a few seconds and **MUTE** icon displays until you turn off mute.

To end mute a call:

- Press **MUTE** again. When mute is off, **Microphone ON** appears temporarily on the telephone base.

Mute is automatically canceled when you end the call.

Options while on calls

Temporary tone dialing

If you have pulse (rotary) service only, you can switch from pulse to touch-tone dialing temporarily during a call. This is useful if you need to send touch-tone signals to access your telephone banking or long distance services.

1. During a call, press **TONEX** on the handset or telephone base.
2. Use the dialing keys to enter the desired number. The telephone sends touch-tone signals.
3. The telephone automatically returns to pulse dialing after you end the call.

Hold

You can place any call on hold. You hear an alert tone at the telephone base if you have not taken the call off of hold after 14 minutes. You hear another alert tone at the telephone base 30 seconds later. At 15 minutes on hold, the call on hold automatically disconnects.

To place a home call on hold:

- While on a home call, press **OPTION**, and then press **SELECT** on the handset or telephone base to select **HOLD**. **Home call on hold** appears on the handsets and telephone base. **HOME/FLASH** flashes on the handsets and **HOME** flashes on the telephone base.

To resume a home call on hold:

- Press **HOME/FLASH** on handsets or **HOME** on the telephone base.

To place a cell call on hold:

- While on a cell call, press **OPTION**, and then press **SELECT** on the handset or telephone base to select **HOLD**. **Cell 1/2 call on hold** appears on the handsets and telephone base. **CELL 1** or **CELL 2** on the handsets and **CELL 1** or **CELL 2** on the telephone base flash.

To resume a cell call on hold:

- Press **CELL 1** or **CELL 2** on the handset, or press **CELL 1** or **CELL 2** on the telephone base.

Options while on calls

Equalizer

The equalizer feature enables you to change the quality of the audio to best suit your hearing.

Using a cordless handset or the telephone base:

1. While on a home call or cell call, press **OPTION**.
2. Press **▼CID** or **▲DIR** on the handset, or press **▼CALLER ID** or **▲DIRECTORY** on the telephone base to highlight **Equalizer**, then press **SELECT**.
3. Press **▼CID** or **▲DIR** on the handset, or press **▼CALLER ID** or **▲DIRECTORY** on the telephone base to select **Treble 1**, **Treble 2**, **Bass** or **Natural** (the default setting), then press **SELECT**.



Notes:

- ▶ If you switch the call between the handset and speakerphone by pressing **◀▶/SPEAKER**, the audio setting remains unchanged.
- ▶ The current equalizer setting remains unchanged until you select a new setting.

Chain dialing

Use this feature to initiate a dialing sequence from the numbers in the directory, caller ID log or redial memory while you are on a call.

Chain dialing is useful when you wish to access other numbers (such as bank account numbers or access codes) from the directory, caller ID log or redial list.

Using a cordless handset:

To access the directory while on a call:

1. Press **OPTION**.
2. Press **▼CID** or **▲DIR** to scroll to **Directory**, then press **SELECT**.
3. Press **▼CID** or **▲DIR** to scroll to the desired directory, then press **REVIEW**.
4. Press **▼CID** or **▲DIR** to highlight the desired entry or perform an alphabetical search (page 92).
5. Press **DIAL** to dial the number shown.

Options while on calls

To access the caller ID log while on a call:

1. Press **OPTION**.
2. Press **▼CID** or **▲DIR** to scroll to **Caller ID log**, then press **SELECT**.
3. Press **▼CID** or **▲DIR** to scroll to the desired entry, then press **CALL** to dial the number shown.

To access the redial list while on a call:

1. Press **REDIAL/PAUSE** to show the most recently dialed number.
2. Press **▼CID** or **▲DIR** to scroll to the desired number, or press **REDIAL/PAUSE** repeatedly to find the desired number. Press **DIAL** to dial the number shown.

Using the telephone base:

To access the directory while on a call:

1. Press **OPTION**.
2. Press **▼CALLER ID** or **▲DIRECTORY** to scroll to **Directory** and then press **SELECT**.
3. Press **▼CALLER ID** or **▲DIRECTORY** to scroll to the desired directory, then press **REVIEW**.
4. Press **▼CALLER ID** or **▲DIRECTORY** to scroll to the desired entry. Press **DIAL** to dial the number shown.

To access the caller ID log while on a call:

1. Press **OPTION**.
2. Press **▼CALLER ID** or **▲DIRECTORY** to scroll to **Caller ID log** and then press **SELECT**.
3. Press **▼CALLER ID** or **▲DIRECTORY** to scroll to the desired number.
4. Press **CALL** to dial the number shown.

To access the redial list while on a call:

1. Press **REDIAL/PAUSE** to show the most recently dialed number.
2. Press **▼CALLER ID** or **▲DIRECTORY** to scroll to the desired number, or press **REDIAL/PAUSE** repeatedly to find the desired number. Press **DIAL** to dial the number shown.

Options while on calls



Notes:

- ▶ You cannot edit a directory entry while on a call. For more details about the directory, see pages 86-96.
- ▶ You cannot copy a caller ID entry into the directory while on a call. For more details about the caller ID log, see pages 97-107.
- ▶ If you press **REDIAL/PAUSE** while on a call, you can only view the ten most recently dialed numbers but you cannot erase the entries. For more details about the redial memory, see pages 66-70.
- ▶ Press  **OFF/CANCEL** on the handset or **CANCEL** on the telephone base to exit redial, directory or caller ID log when on a call.

Redial

The telephone base and each handset store the last 10 dialed numbers (up to 30 digits each) in the redial list. The redial entries of each handset and the telephone base are independent.

Review the redial list

To review the redial list of a handset:

1. Press **REDIAL/PAUSE** in idle mode.
2. Press **▼CID, ▲DIR** or **REDIAL/PAUSE** repeatedly to browse through the list. The handset beeps twice at the end of the list.
3. Press **OFF/CANCEL** to exit.

To review the redial list of the telephone base:

1. Press **REDIAL/PAUSE** in idle mode.
2. Press **▼CALLER ID, ▲DIRECTORY** or **REDIAL/PAUSE** repeatedly to browse through the list. The telephone base beeps twice at the end of the list.
3. Press **CANCEL** to exit.

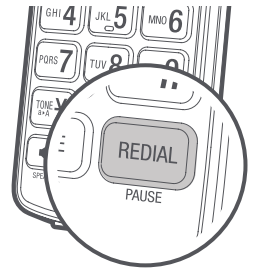

Dial a redial entry

To dial a redial entry on a handset:

1. Press **HOME/FLASH**, or **)/SPEAKER** to use the home line, then press **REDIAL/PAUSE** to enter the redial list.
2. Press **▼CID, ▲DIR** or **REDIAL/PAUSE** repeatedly to browse until the desired number displays. The handset beeps twice at the end of the list.
3. Press **DIAL** to dial the number displayed.

-OR-

1. Press **CELL 1** or **CELL 2** to use the cell line, then press **REDIAL/PAUSE** to enter the redial list.
2. Press **▼CID, ▲DIR** or **REDIAL/PAUSE** repeatedly to browse until the desired number displays. The handset beeps twice at the end of the list.
3. Press **INSERT** to insert the desired number.
4. Press **DIAL** to dial the number displayed.

Redial

You can also select a redial entry before dialing.

1. Press **REDIAL/PAUSE** in idle mode.
2. Press **▼CID**, **▲DIR** or **REDIAL/PAUSE** repeatedly to browse until the desired number displays. The handset beeps twice at the end of the list.
3. Press **⬆️HOME/FLASH**, or **🔊/SPEAKER** to call using the home line, or **CELL 1**, **CELL 2** to call using the cell line.

-OR-

You can insert the area code to the redial number before dialing.

1. Enter the area code in idle mode, then press **REDIAL/PAUSE**.
2. Press **▼CID**, **▲DIR** or **REDIAL/PAUSE** repeatedly to browse until the desired number displays, then press **INSERT**. The area code will be added in front of the selected redial number.
3. Press **⬆️HOME/FLASH**, or **🔊/SPEAKER** to call using the home line, or **CELL 1**, **CELL 2** to call using the cell line.

To dial a redial entry on the telephone base:

1. Press **HOME** to use the home line, then press **REDIAL/PAUSE** to enter the redial list.
2. Press **▼CALLER ID**, **▲DIRECTORY** or **REDIAL/PAUSE** repeatedly to browse until the desired number displays. The handset beeps twice at the end of the list.
3. Press **DIAL** to dial the number displayed.

-OR-

1. Press **CELL 1** or **CELL 2** to use the cell line, then press **REDIAL/PAUSE** to enter the redial list.
2. Press **▼CALLER ID**, **▲DIRECTORY** or **REDIAL/PAUSE** repeatedly to browse until the desired number displays. The handset beeps twice at the end of the list.
3. Press **INSERT** to insert the desired number.
4. Press **DIAL** to dial the number displayed.

Redial

You can also select a redial entry before dialing.

1. Press **REDIAL/PAUSE** in idle mode.
2. Press **▼CALLER ID, ▲DIRECTORY** or **REDIAL/PAUSE** repeatedly to browse until the desired number displays. The telephone base beeps twice at the end of the list.
3. Press **HOME** to call using the home line, or **CELL 1** or **CELL 2** to call using the cell line.

-OR-

You can insert the area code to the redial number before dialing.

1. Enter the area code in idle mode, then press **REDIAL/PAUSE**.
2. Press **▼CALLER ID, ▲DIRECTORY** or **REDIAL/PAUSE** repeatedly to browse until the desired number displays, then press **INSERT**. The area code will be added in front of the selected redial number.
3. Press **HOME** to call using the home line, or **CELL 1, CELL 2** to call using the cell line.

Redial

Save a redial entry to the directory

Using a cordless handset:

1. Press **REDIAL/PAUSE** in idle mode.
2. Press **▼CID, ▲DIR** or **REDIAL/PAUSE** repeatedly to browse until the desired number displays.
3. Press **SAVE**.
4. The screen displays **Edit number**. Use the dialing keys to edit the number, if necessary.
 - Press **MUTE/DELETE** or **BACKSP** to erase a digit.
 - Press and hold **MUTE/DELETE** to erase all digits.
 - Press **▼CID, ▲DIR** to move the cursor to the right or left.
 - Press and hold **REDIAL/PAUSE** to insert a dialing pause (a **p** appears).
5. Press **NEXT**.
6. Press **▼CID, ▲DIR** to highlight one of the following types:
 - Home
 - Cell
 - Work
 - Other
7. Press **NEXT**. The screen displays **Enter name**. Use the dialing keys to enter a name.
 - Press **MUTE/DELETE** or **BACKSP** to erase a character.
 - Press and hold **MUTE/DELETE** to erase all characters.
 - Press **▼CID** or **▲DIR** to move the cursor to the right or left.
8. Press **SAVE**. The screen displays **Saved to directory** and you hear a confirmation tone.

Redial

Using the telephone base:

1. Press **REDIAL/PAUSE** in idle mode.
2. Press **▼CALLER ID**, **▲DIRECTORY** or **REDIAL/PAUSE** repeatedly to browse until the desired number displays.
3. Press **SAVE**.
4. The screen displays **EDIT NUMBER**. Use the dialing keys to edit the number, if necessary.
 - Press **X/DELETE** or **BACKSP** to erase a digit.
 - Press and hold **X/DELETE** to erase all digits.
 - Press **▼CALLER ID** or **▲DIRECTORY** to move the cursor to the right or left.
 - Press and hold **REDIAL/PAUSE** to insert a dialing pause (a **p** appears).
5. Press **NEXT**.
6. Press **▼CALLER ID** or **▲DIRECTORY** to highlight one of the following types:
 - Home
 - Cell
 - Work
 - Other
7. Press **NEXT**. The screen displays **ENTER NAME**. Use the dialing keys to enter a name.
 - Press **X/DELETE** or **BACKSP** to erase a character.
 - Press and hold **X/DELETE** to erase all characters.
 - Press **▼CALLER ID** or **▲DIRECTORY** to move the cursor to the right or left.
8. Press **SAVE**. The screen displays **Saved to directory** and you hear a confirmation tone.

Delete a redial entry

1. Press **REDIAL/PAUSE** on the handset or telephone base in idle mode.
2. Press **▼CID** or **▲DIR** on the handset, or press **▼CALLER ID**, **▲DIRECTORY** on the telephone base.
-OR-
Press **REDIAL/PAUSE** repeatedly to browse until the desired number displays.
3. Press **MUTE/DELETE** on the handset or **X/DELETE** on the telephone base to delete the displayed number. You hear a confirmation tone.

Handset locator

The handset locator feature is useful if you misplace any handsets.



To start paging:

Press /**HANDSET LOCATOR** on the telephone base to start the paging tone on all handsets for 60 seconds. All idle handsets ring and display **** Paging ****.



Note: If you press  **OFF/CANCEL, QUIET#, MUTE/DELETE** or **MUTE** on a handset, the ringer of that handset stops, but the paging to the rest of the handsets continues.

To stop paging:

- › Press  **HOME/FLASH**,  **SPEAKER**, or any dialing key (**0-9, TONE ***) on the handset(s).
- OR-**
- › Press /**HANDSET LOCATOR, MUTE, CANCEL** or **STOP** on the telephone base.

Multiple handset use

Join a call in progress

Another handset can join you on an outside call. The call continues until all people hang up. You can share an outside call with telephone base and up to 4 system handsets.

To join a home call:

Using a cordless handset:

Press  **HOME/FLASH** or  **SPEAKER** on another handset to join the call.

Using the telephone base:

Press **HOME** to join the call.

To join a cell call:

Using a cordless handset:

Press **CELL 1**  or **CELL 2**  on another handset to join the call.

Using the telephone base:

Press **CELL 1** or **CELL 2** to join the call.

Intercom

Use the intercom feature for conversations between two handsets, a handset and the telephone base, or a handset/telephone base and a cordless headset/speakerphone (sold separately). You can buy additional expansion handsets (model AT&T CLP99007), cordless headsets and speakerphones for this telephone base to expand your telephone system (up to 12 handsets or 10 cordless handsets and two cordless headsets/speakerphones).

Using a cordless handset:

- Press **MENU** in idle mode to enter the main menu. Press **▼CID** or **▲DIR** to scroll to **Intercom**, then press **SELECT**.
 - If you have one handset and no other registered devices, the handset shows **Calling base**.
 - If you have other registered device(s) or more than one handset, the handset shows **INTERCOM TO:**. Use the dialing keys to enter a specific device number (**0** for the telephone base, **1-9** for handsets 1-9, **TONEX** followed by **0-2** for handsets 10-12, or **#** for a single headset/speakerphone, **#** followed by **1** or **2** for headset/speakerphone 1 or 2, or **TONEX** followed by **#** for all devices), or press **▼CID** or **▲DIR** to scroll to the desired device and press **SELECT**. Your handset screen shows **Calling HANDSET X**, **Calling BASE 0**, **Calling headset** or **Calling all devices**.

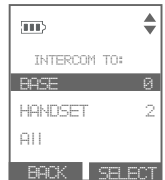

The destination device(s) rings and shows **HANDSET is calling**, **HANDSET X is calling** or **HANDSET X is calling all** (**HANDSET** represents the handset name, **X** represents the handset number).

- To answer the intercom call, press **HOME/FLASH**, **📞/SPEAKER**, **CELL 1** (📞), **CELL 2** (📞) or any dialing key (**0-9**, **TONEX**) on the destination handset, or press **HOME** on the telephone base. Both devices now show **Intercom**.
- To end the intercom call, one party presses **END**, **🔌/OFF/CANCEL**, or places the handset back in the telephone base or charger; or one party presses **END** on the telephone base. The other party hears four beeps. Both devices display **Intercom ended**.

Intercom

Using the telephone base:

- Press **MENU** in idle mode to enter the main menu.
Press **▼CALLER ID** or **▲DIRECTORY** to scroll to **Intercom**, then press **SELECT**.
 - If you have one handset and no other registered devices, the telephone base shows **Calling HANDSET X**.
 - If you have other registered device(s) or more than one handset, the telephone base shows **INTERCOM TO:**. Use the dialing keys to enter a specific handset number (**1-9** for handsets 1-9, **TONEX** followed by **0-2** for handsets 10-12, or **#** for a single headset/speakerphone, **#** followed by **1** or **2** for headset/speakerphone 1 or 2, or **TONEX** followed by **#** for all devices), or press **▼CALLER ID** or **▲DIRECTORY** to scroll to the desired handset and press **SELECT**. The telephone base shows **Calling HANDSET X** or **Calling all**.



The destination handset(s) rings and shows **Base is calling, BASE 0 is calling** or **BASE 0 is calling all**.

- To answer the intercom call, press **HOME, CELL 1, CELL 2** or any dialing key (**0-9, TONEX**) on the telephone base. Both the base and the handset now show **Intercom**.
- To end the intercom call, one party presses **END**, **OFF/CANCEL**, or places the handset back in the telephone base or charger; or one party presses **END** on the telephone base. The other party hears four beeps. Both devices display **Intercom ended**.



Notes:

- Before the intercom call is answered, you can cancel it by pressing **OFF/CANCEL** on the handset or **END** on the telephone base.
- If the called party does not answer within 100 seconds, or if the device is in use, on a call or out of range, the initiating device shows **No answer. Try again..**
- To temporarily silence the intercom ringer, press **OFF/CANCEL** or **MUTE/DELETE** on the handset, or press **CANCEL** or **MUTE** on the telephone base.
- You can only use one pair of devices at a time to make intercom calls.
- For cordless headsets and speakerphones, refer to the corresponding user's manual on how to answer and end an intercom call.
- If a total of two cordless headset(s) and/or speakerphone(s) are registered to the telephone base, they appear as **HEADSET 1** and **HEADSET 2**, respectively, in the intercom menu.

Intercom

Answer an incoming call during an intercom call

When you receive an incoming home call during an intercom call, the two handsets on the intercom call hear an alert tone.

To answer a home call during an intercom call:

Using a cordless handset:

- ▶ Press **HOME/FLASH** to answer the home call. The intercom call ends automatically.
- ▶ Press **OFF/CANCEL** to end the intercom call without answering the incoming call. The telephone continues to ring. You can press **HOME/FLASH** to answer the call.

Using the telephone base:

- ▶ Press **HOME** to answer the home call and the intercom call ends automatically.
- ▶ Press **BACK** and then **END** to end the intercom call without answering the incoming call. The telephone continues to ring. You can press **HOME** to answer the call.

To answer a cell call during an intercom call:

When you receive an incoming cell call during an intercom call, the two handsets on the intercom call hear an alert tone.

Using a cordless handset:

- ▶ Press **CELL 1** or **CELL 2** to answer the cell call and the intercom call ends automatically.

Using the telephone base:

- ▶ Press **CELL 1** or **CELL 2** to answer the cell call. The intercom call ends automatically.



Notes:

- ▶ If Smart call blocker is on and in screening mode, the telephone will screen incoming calls with numbers that are not saved in your directory or allow list, or with names that are not saved in the star name list. See **About Smart call blocker** on page 108.
- ▶ For cordless headsets and speakerphones, refer to the corresponding user's manual on how to answer an incoming call during an intercom call.

Call transfer using intercom

Use the intercom feature to transfer an outside call to another system handset or the telephone base. You can also share an outside call with another system handset or the telephone base.

To transfer or share an outside call using intercom:

Using a cordless handset:

1. During the call, press **OPTION**.
2. Press **▼CID** or **▲DIR** to scroll to **Intercom**, then press **SELECT**.
 - If you have one handset and no other registered devices, the handset shows **Calling base**.
 - If you have other registered device(s) or more than one handset, the handset shows **INTERCOM TO:**. Use the dialing keys to enter a specific device number (**0** for the telephone base, **1-9** for handsets 1-9, **#** for a single headset/speakerphone, **#** followed by **1** or **2** for headset/speakerphone 1 or 2, or **TONEX** followed by **0-2** for handsets 10-12, or **TONEX** followed by **#** for all devices), or press **▼CID** or **▲DIR** to scroll to the desired device and press **SELECT**.

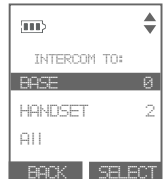

The call is automatically put on hold. Your handset screen shows **Calling HANDSET X**, **Calling BASE 0** or **Calling all**. The destination device rings and displays **HANDSET X is calling**, or **HANDSET X is calling all**.

3. To answer the intercom call on the other device, press **▲HOME/FLASH**, **🔊/SPEAKER**, **CELL 1** (📞), **CELL 2** (📞) or any dialing key (**0-9**, **TONEX**) on the destination handset, or press **▲HOME** on the telephone base.
4. From this intercom call, you have the following options:
 - You can transfer the call. Press **OPTION** and then press **SELECT** to select **Transfer** on the calling handset. Your screen shows **Call transferred**. The other device automatically connects to the outside call.
 - You can let the other device join you on the outside call in a three-way conversation. Press **OPTION**. Press **▼CID** or **▲DIR** to highlight **Share call**, then press **SELECT**.
 - You can end the intercom call and continue the outside call with your handset. Press **🔍OFF/CANCEL**, **END**, **▲HOME/FLASH**, **CELL 1** (📞) or **CELL 2** (📞) on your handset (the ended intercom call party hears four beeps).



Notes:

- If you want to cancel an intercom call and reconnect to the outside call before the destination handset answers, press **🔍OFF/CANCEL** on the originating handset.
- If the called device is not answered within 100 seconds, or if the device is in use, on a call or out of range, the initiating device shows **No answer. Try again..**

Call transfer using intercom

Using the telephone base:

1. During the call, press **OPTION**.
2. Press **▼CALLER ID** or **▲DIRECTORY** to scroll to **Intercom**, then press **SELECT**.
 - ▶ If you have one handset and no other registered devices, the handset shows **Calling HANDSET**.
 - ▶ If you have other registered device(s) or more than one handset, the handset shows **INTERCOM TO:**. Use the dialing keys to enter a specific handset number (**1-9** for handsets 1-9, **TONEX** followed by **0-2** for handsets 10-12, **#** for a single headset/speakerphone, **#** followed by **1** or **2** for headset/speakerphone 1 or 2, or **TONEX** followed by **#** for all devices), or press **▼CALLER ID** or **▲DIRECTORY** to scroll to the desired device and press **SELECT**.



The call is automatically put on hold. Your handset screen shows **Calling HANDSET X** or **Calling all**, The destination handset(s) rings and displays **BASE 0 is calling**.

3. To answer the call on any destination handset, press **HOME, CELL 1, CELL 2** or any dialing key (**0-9, TONEX**). Both the handset and the telephone base now show **Intercom**.
4. From this intercom call, you have the following options:
 - ▶ You can transfer the call. Press **OPTION** and then press **SELECT** to select **Transfer** on the telephone base. The telephone base shows **Call transferred**. The destination handset automatically connects to the outside call.
 - ▶ You can let the handset join you on the outside call in a three-way conversation. Press **OPTION**. Press **▼CALLER ID** or **▲DIRECTORY** to highlight **Share call**, then press **SELECT**.
 - ▶ You can end the intercom call and continue the outside call on the telephone base. Press **CANCEL, END, CELL 1** or **CELL 2** on the telephone base. The destination handset shows **Intercom ended**.



Notes:

- ▶ To cancel the call transfer and return to the external call before the intercom call is answered, press **CANCEL** on the telephone base.
- ▶ If the other device does not answer the intercom call within 100 seconds, or if the device is in use, on a call or out of range, the initiating device shows **No answer. Try again.** and returns to the outside call.

Push-to-talk (PTT)

You can directly broadcast messages to the speakerphone of any device. Press and hold **PUSH TO TALK** on a handset or **PTT/FLASH** on the telephone base to begin two-way communication.

- ▶ Only one device can talk at a time. While talking to another device, press and hold **PUSH TO TALK** on the handset or **PTT/FLASH** on the telephone base.
- ▶ You must release **PUSH TO TALK** on the handset or **PTT/FLASH** on the telephone base, so the other person can respond.
- ▶ Only one PTT session can be active at a time.
- ▶ While PTT is in use between two devices, other devices cannot use the intercom feature but can access the answering system.
- ▶ When you attempt to place a PTT call to another device which is accessing the answering system or on an intercom call or outside call, your device screen shows **Not available at this time**.

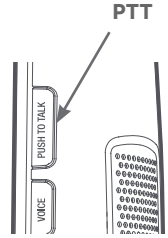

Note: The PTT function is not available when **QUIET** mode is on.

Turn PTT on or off

Using a cordless handset:

1. Press **PUSH TO TALK** when the handset is not in use. The **PUSH TO TALK** menu displays.
2. Press **▼CID** or **▲DIR** to highlight **PTT On/Off**, then press **SELECT**.
3. Press **▼CID** or **▲DIR** to choose **On** or **Off**, then press **SELECT**.



Using the telephone base:

1. Press **PTT/FLASH** when the telephone base is not in use. The **PUSH TO TALK** menu displays.
2. Press **▼CALLER ID** or **▲DIRECTORY** to highlight **PTT On/Off**, then press **SELECT**.
3. Press **▼CALLER ID** or **▲DIRECTORY** to choose **On** or **Off**, then press **SELECT**.



Note: The handset or the telephone base screen displays **No PTT call** when PTT is turned off.

Push-to-talk (PTT)

PTT call to a single device

Using a cordless handset:

1. There are a few ways to begin a PTT call to a single device. When the handset is not in use:
 - If you have one handset, press and hold **PUSH TO TALK**.
 - If you have more than one handset:
 - ◆ Press **PUSH TO TALK** on the handset, then use the dialing keys to enter the destination device number.
 - OR-
 - ◆ Press **PUSH TO TALK** on the handset. Press **▼CID** or **▲DIR** to highlight the destination device number, then press **SELECT** or **PUSH TO TALK**.

The handset shows **Connecting to HANDSET X...** (**HANDSET** represents the handset name, **X** represents the destination handset number) or **Connecting to BASE 0...** (**BASE** represents the base name) for a few seconds. When the connection is made, both your and the destination device screens display **Press and hold [PTT] to talk**.
2. Press and hold **PUSH TO TALK**. A chirp indicates your microphone is on. Speak towards the device. Your voice is broadcast to the destination device. While you are speaking, your handset shows **PTT To HANDSET X** or **PTT To BASE 0**.
3. Release **PUSH TO TALK** after speaking. Both devices beep once again and the screens show **Press and hold [PTT] to talk**, then you can press and hold **PUSH TO TALK** to continue speaking or the destination device can respond (see **Answer a PTT call** on page 83).
4. To end the PTT call, press **OFF/CANCEL** or **END**, or place the handset in the telephone base or charger. The handset shows **Push to talk ended**.



Note: After **PUSH TO TALK** is released, the PTT call remains open for a short time. If no one presses **PUSH TO TALK** within 10 seconds, the PTT call ends automatically.

Push-to-talk (PTT)

Using the telephone base:

1. There are a few ways to begin a PTT call to a single handset. When the telephone base is not in use:
 - If you have one handset, press and hold **PTT/FLASH**.
 - If you have more than one handset:
 - ◆ Press **PTT/FLASH**, then use the dialing keys to enter the destination handset number.

-OR-

 - ◆ Press **▼CALLER ID** or **▲DIRECTORY** to highlight the destination handset number, then press **SELECT** or **PTT/FLASH**.

The telephone base shows **Connecting to HANDSET X...** (**HANDSET** represents the handset name, **X** represents the destination handset number) for a few seconds. When the connection is made, both the telephone base and destination handset display **Press and hold [PTT] to talk**.

2. Press and hold **PTT/FLASH**. A chirp indicates your microphone is on. Speak towards the telephone base. Your voice is broadcast to the destination handset. While you are speaking, the telephone base shows **PTT To HANDSET X**.
3. Release **PTT/FLASH** after speaking. Both devices beep once again and the screens show **Press and hold [PTT] to talk**, then you can press and hold **PTT/FLASH** to continue speaking or the destination device can respond (see **Answer a PTT call** on page 83).
4. To end the PTT call, press **CANCEL** or **END**. The telephone base shows **Push to talk Ended** for a few seconds.



Note: After **PTT/FLASH** is released, the PTT call remains open for a short time. If no one presses **PTT/FLASH** within 10 seconds, the PTT call ends automatically.

Push-to-talk (PTT)

PTT call to multiple devices

When there are multiple handsets registered to the phone system, PTT supports one-to-group calls. PTT supports a maximum of one-to-four calls when one to five handsets are registered, and a maximum of one-to-three calls when six or more handsets are registered. The first three or four registered handsets will be able to use this feature. Other handsets can only use PTT for one-to-one calls.

To call multiple devices:

Using a cordless handset:

1. You have two ways to call multiple devices. When the handset is not in use:
 - Press and hold **PUSH TO TALK** until the handset shows **Connecting to group...**
 - Press **PUSH TO TALK**. Press **▼CID** or **▲DIR** to choose **Group**. Press **SELECT** or press **PUSH TO TALK** and your handset shows **Connecting to group...**

When the connection is made, both the caller and the destination parties hear a beep. The speakerphones on all other devices automatically activate.

2. You need to press and hold **PUSH TO TALK** when you want to speak. Speak towards the handset. Your voice is broadcast to all devices.
3. Release **PUSH TO TALK** after speaking.
4. Any extension can reply (see **Answer a PTT call** on page 83).



Note: After **PUSH TO TALK** is released, the PTT call remains open for a short time. If no one presses **PUSH TO TALK** within 10 seconds, the PTT call ends automatically.

Push-to-talk (PTT)

Using the telephone base:

1. You have two ways to call multiple handsets. When the telephone base is not in use:
 - Press and hold **PTT/FLASH** until the screen shows **Connecting to group...**
 - Press **PTT/FLASH**. Press **▼CALLER ID** or **▲DIRECTORY** to choose **Group**. Press **SELECT** or press **PTT/FLASH** and the telephone base shows **Connecting to group...**

When the connection is made, both the caller and the destination parties hear a beep. The speakerphones on all other devices automatically activate.
2. You need to press and hold **PTT/FLASH** when you want to speak. Speak towards the telephone base. Your voice is broadcast to all devices.
3. Release **PTT/FLASH** after speaking.
4. Any extension can reply (see **Answer a PTT call** on page 83).



Note: After **PTT/FLASH** is released, the PTT call remains open for a short time. If no one presses **PTT/FLASH** within 10 seconds, the PTT call ends automatically.

Push-to-talk (PTT)

Answer a PTT call

You can respond to a PTT call, as described below.

Using a cordless handset or the telephone base:

1. When your device receives a PTT call, it beeps and shows **Press and hold [PTT] to talk**.
2. When the other party is speaking, your speakerphone light is on, and your device shows:
 - **PTT From HANDSET X To devices: X** (the first **X** represents the initiating handset number, and the second **X** represents your handset number; a maximum of four handset numbers appear).
 - OR-
 - **PTT From BASE 0 To devices: X** (the **X** represents your handset number; a maximum of four handset numbers appear).
3. When your speakerphone light is off (the screen shows **Press and hold [PTT] to talk**), press and hold **PUSH TO TALK** on your handset or **PTT/FLASH** on your telephone base. You will hear a chirp. Speak towards the device.
 - While you are speaking, your device shows **PTT To BASE 0** or **PTT To HANDSET X** (**X** represents the destination handset number), or **PTT To devices: X** (**X** represents the handset numbers of one or more destination handsets; a maximum of four handset numbers appear).
 - Your voice is broadcast to all destination devices.

After speaking, release **PUSH TO TALK** on your handset or **PTT/FLASH** on your telephone base. Your device will beep. After the beep, if your speakerphone light is off, you can press and hold **PUSH TO TALK** on your handset or **PTT/FLASH** on your telephone base to continue speaking, or the destination device can respond.

Push-to-talk (PTT)

Change a one-to-one PTT call to an intercom call

You can convert a one-to-one PTT session to an intercom call.

Using a cordless handset or the telephone base:

1. When your device shows **Press and hold [PTT] to talk**, press **INTCOM**. The screen shows **Switch to Intercom?**.
2. Press **SELECT**. Your device displays **Calling BASE 0** or **Calling HANDSET X**. The destination device briefly shows **Push to talk Ended** and then **HANDSET X is calling** or **BASE 0 is calling**. The destination device rings.
3. Press **HOME/FLASH** or any dialing keys (**0-9**, or **TONEX**) on the destination handset, or press **HOME** or any dialing keys (**0-9**, or **TONEX**) on the telephone base to answer the intercom call. Both devices now show **Intercom**.
4. To end the intercom call, press **OFF/CANCEL** on your handset or place the handset in the telephone base or charger, or press **END** on the handset or telephone base. Both screens show **Intercom ended**.

Answer an incoming call during a PTT call

When you receive an outside call during PTT, there is an alert tone.

Using a cordless handset or the telephone base:

- During a one-to-one PTT call, press **HOME/FLASH, CELL 1** or **CELL 2** on the initiating or destination handset, or press **HOME, CELL 1** or **CELL 2** on the telephone base. The PTT call ends automatically and the outside call is answered.
- During a one-to-group PTT call, press **HOME/FLASH, CELL 1** or **CELL 2** on the initiating handset, or press **HOME, CELL 1** or **CELL 2** on the telephone base. The PTT call ends automatically and the outside call is answered.
- During a one-to-group PTT call, press **HOME/FLASH, CELL 1** or **CELL 2** on any one of the destination handsets, or press **HOME, CELL 1** or **CELL 2** on the telephone base. That device answers the outside call. The PTT call continues for the rest of the PTT participants.
- To leave the PTT call without answering the incoming call, press **OFF/CANCEL** on your handset or **CANCEL** on your telephone base. The telephone continues to ring.

Push-to-talk (PTT)

Make an outgoing call during a PTT call

Using a cordless handset or the telephone base:

- ▶ During a one-to-one PTT call, press **HOME/FLASH** on your handset or press **HOME** on the telephone base to get a dial tone. The PTT call ends automatically.
- ▶ During a one-to-group PTT call, press **HOME/FLASH** on the initiating handset or press **HOME** on the telephone base. The PTT call ends automatically and you get a dial tone.
- ▶ During a one-to-group PTT call, press **HOME/FLASH** on any one of the destination handsets or press **HOME** on the telephone base. That device gets a dial tone. The PTT call continues for the rest of the PTT participants.

End or leave a PTT call

Using a cordless handset or the telephone base:

For one-to-one PTT calls, both initiating and destination devices can end the PTT call. For PTT calls to multiple devices, the initiating device can end the PTT call. If any one of the destination devices leaves the PTT call, the call continues until all participants or the initiator hangs up.

Press **OFF/CANCEL** or **END** on the handset, or press **CANCEL** or **END** on the telephone base. The screen shows **Push to talk Ended**.

-OR-

Place the handset in the telephone base or charger, then the handset returns to idle mode.



Note: After **PUSH TO TALK** on the handset or **PTT/FLASH** on the telephone base is released, the PTT call remains open for a short time. If no one presses **PUSH TO TALK** on the handset or **PTT/FLASH** on the telephone base within 10 seconds, the PTT call ends automatically.

About the directory

The home directory stores up to 200 entries with up to 30 digits for each phone number and 15 characters for each name. Each of the downloaded directories stores up to 1,500 entries with up to 30 digits for each phone number and 15 characters for each name.

- Directory entries are stored at the telephone base and shared by all system handsets. Any changes made on one device apply to all.
- Only one device can review the directory at a time. If another device tries to enter the directory, its screen shows **Not available at this time.**
- When there are no records in the directory, the screen shows **Directory empty.**
- When the directory is full and you try to save an entry, the screen shows **Directory full.**
- When you try to save a number already stored in the directory, the screen shows **Number already saved.**
- Directory entries can also be saved to the allow list or block list. See **Allow list** on page 122 and **Block list** on page 116.
- When Smart call blocker is on, calls with numbers saved in the directory will get through and ring on your telephone. If a number saved in the directory is also saved in the block list, calls from this number will be blocked.

Create directory entries

Create a new entry in the home directory

Using a cordless handset:

1. Press **MENU** on the handset in idle mode to enter the main menu.
 2. Press **▼CID** or **▲DIR** to scroll to **Directory**, then press **SELECT**.
 3. Press **OPTION** to choose **Home**.
 4. Press **SELECT** to choose **Add contact**. The screen displays **Enter number**.
 5. Use the dialing keys to enter a telephone number.
 - Press **▼CID** or **▲DIR** to move the cursor to the left or right.
 - Press **MUTE/DELETE** or **BACKSP** to erase a digit.
 - Press and hold **MUTE/DELETE** to erase all digits.
 - Press and hold **REDIAL/PAUSE** to enter a dialing pause (a **p** appears).
- OR-**
- Copy a number from the redial list. Press **REDIAL/PAUSE** and then **▼CID**, **▲DIR** or **REDIAL/PAUSE** repeatedly to locate the number. Press **INSERT** to copy the displayed number.
6. Press **NEXT**.
 7. Press **▼CID** or **▲DIR** to highlight one of the following types:
 - Home
 - Cell
 - Work
 - Other
 8. Press **NEXT**. The screen displays **Enter name**.
 9. Use the dialing keys (see page 89) to enter a name (up to 15 characters).
 - Press **▼CID** or **▲DIR** to move the cursor to the left or right.
 - Press **0** to add a space.
 - Press **MUTE/DELETE** or **BACKSP** to erase a character.
 - Press and hold **MUTE/DELETE** to erase all characters.
 - Press **a>A** to change the next letter to upper or lower case.
 10. Press **SAVE** to confirm and the screen shows **Saved to directory**. You hear a confirmation tone.

Create directory entries

Create a new entry in the home directory

Using the telephone base:

1. Press **MENU** on the telephone base in idle mode to enter the main menu.
2. Press **▼CALLER ID** or **▲DIRECTORY** to scroll to **Directory**, then press **SELECT**.
3. Press **OPTION** to choose **Home**.
4. Press **SELECT** to choose **Add contact**. The screen displays **ENTER NUMBER**.
5. Use the dialing keys to enter a telephone number.
 - Press **▼CALLER ID** or **▲DIRECTORY** to move the cursor to the left or right.
 - Press **X/DELETE** or **BACKSP** to erase a digit.
 - Press and hold **X/DELETE** to erase all digits.
 - Press and hold **REDIAL/PAUSE** to enter a dialing pause (a **p** appears).

-OR-

Copy a number from the redial list. Press **REDIAL/PAUSE** and then **▼CALLER ID** or **▲DIRECTORY** or **REDIAL/PAUSE** repeatedly to locate the number. Press **INSERT** to copy the displayed number.

6. Press **NEXT**.
7. Press **▼CALLER ID** or **▲DIRECTORY** to highlight one of the following types:
 - Home
 - Cell
 - Work
 - Other
8. Press **NEXT**. The screen displays **ENTER NAME**.
9. Use the dialing keys (see page 89) to enter a name (up to 15 characters).
 - Press **▼CALLER ID** or **▲DIRECTORY** to move the cursor to the left or right.
 - Press **0** to add a space.
 - Press **X/DELETE** or **BACKSP** to erase a character.
 - Press and hold **X/DELETE** to erase all characters.
 - Press **a>A** to change the next letter to upper or lower case.
10. Press **SAVE** to confirm and the screen shows **Saved to directory**. You hear a confirmation tone.

Create directory entries

Dialing keys

Dialing keys	Characters by number of key presses										
	1	2	3	4	5	6	7	8	9	10	11
1	1	.	-	'	()	*	#	&	/	,
2	A	B	C	a	b	c	2				
3	D	E	F	d	e	f	3				
4	G	H	I	g	h	i	4				
5	J	K	L	j	k	l	5				
6	M	N	O	m	n	o	6				
7	P	Q	R	S	p	q	r	s	7		
8	T	U	V	t	u	v	8				
9	W	X	Y	Z	w	x	y	z	9		
0	space	0									
*											
#											



Note: When entering a name in the directory, the first letter of each word is automatically capitalized.

Create directory entries

Add a predialed telephone number to the directory

You can save a predialed telephone number to the directory.

Using a cordless handset:

1. Enter the telephone number when in idle mode, then press **SAVE** to move on to edit the number and then press **NEXT**.
2. Press **▼CID** or **▲DIR** to highlight one of the following types:
 - Home
 - Cell
 - Work
 - Other
3. Press **NEXT**. The screen displays **Enter name**.
4. Use the dialing keys to edit the name.
 - Press **▼CID** or **▲DIR** to move the cursor to the left or right.
 - Press **MUTE/DELETE** or **BACKSP** to erase a character.
 - Press and hold **MUTE/DELETE** to erase all characters.
5. Press **SAVE** to save the entry. There is a confirmation tone and the screen shows **Saved to directory**.

Using the telephone base:

1. Enter the telephone number when in idle mode, then press **SAVE** to move on to edit the number and then press **NEXT**.
2. Press **▼CALLER ID** or **▲DIRECTORY** to highlight one of the following types:
 - Home
 - Cell
 - Work
 - Other
3. Press **NEXT**. The screen displays **ENTER NAME**.
4. Use the dialing keys to edit the name.
 - Press **▼CALLER ID** or **▲DIRECTORY** to move the cursor to the left or right.
 - Press **X/DELETE** or **BACKSP** to erase a character.
 - Press and hold **X/DELETE** to erase all characters.
5. Press **SAVE** to save the entry. There is a confirmation tone and the screen shows **Saved to directory**.

Review the directory

Review directory entries

Using the handset:

1. Press **^DIR** on the handset when in idle mode.
2. Press **▼CID** or **^DIR** to highlight a directory, then press **REVIEW**.
3. Press **▼CID** or **^DIR** to browse.

-OR-

1. Press **MENU** when in idle mode.
2. Press **▼CID** or **^DIR** to highlight **Directory**, then press **SELECT**.
3. Press **▼CID** or **^DIR** to highlight a directory, then press **REVIEW**.
4. Press **▼CID** or **^DIR** to browse.

-OR-

1. Press **OPTION** while on a call.
2. Press **▼CID** or **^DIR** to highlight **Directory**, then press **SELECT**.
3. Press **▼CID** or **^DIR** to highlight a directory, then press **REVIEW**.
4. Press **▼CID** or **^DIR** to browse.

Using the telephone base:

1. Press **▲DIRECTORY** on the telephone base when in idle mode.
2. Press **▼CALLER ID** or **▲DIRECTORY** to highlight a directory, then press **REVIEW**.
3. Press **▼CALLER ID** or **▲DIRECTORY** to browse.

-OR-

1. Press **MENU** when in idle mode.
2. Press **▼CALLER ID** or **▲DIRECTORY** to highlight **Directory**, then press **SELECT**.
3. Press **▼CALLER ID** or **▲DIRECTORY** to highlight a directory, then press **REVIEW**.
4. Press **▼CALLER ID** or **▲DIRECTORY** to browse.

-OR-

1. Press **OPTION** while on a call.
2. Press **▼CALLER ID** or **▲DIRECTORY** to highlight **Directory**, then press **SELECT**.
3. Press **▼CALLER ID** or **▲DIRECTORY** to highlight a directory, then press **REVIEW**.
4. Press **▼CALLER ID** or **▲DIRECTORY** to browse.



Notes:

- ▶ When the desired entry displays, press **#** (pound key) on the handset or telephone base repeatedly to show different dialing options.
- ▶ **Directory empty** appears if there are no directory entries.

Search the directory

3-character alphabetical search

You can use the enhanced 3-character search to find your contacts quickly and efficiently.

1. Follow the steps in **Review directory entries** on the previous page to enter the directory.
2. When an entry appears, use the dialing keys to enter the letters associated with the name (see page 89). You can enter up to 3 letters for the search. The letters will show at the top left hand corner of the screen. After you have entered one to three letters, the system starts searching in the directory. If there is no name matching the letter(s) entered, the next closest match in alphabetical order appears. If necessary, press **▼CID** or **▲DIR** on the handset, or **▼CALLER ID** or **▲DIRECTORY** on the telephone base to browse.



Note: The cursor automatically moves to the next position 2 seconds after you enter a letter. If you do not enter another letter in the coming 2 seconds, the system starts searching in the directory.

Dial a directory entry

You can dial a directory entry on any line.

To dial a directory entry:

1. Search for the desired entry in the directory (see **Review directory entries** and **3-character alphabetical search** on pages 91-92).
2. When the desired entry appears, press **#** (pound key) repeatedly on the handset or telephone base to show different dialing options.
3. When the displayed number is in the correct format, press **🏠HOME/FLASH** or **🗣️/SPEAKER** on the handset, or press **HOME** on the telephone base to use the home line. Press **CELL 1** (📶) or **CELL 2** (📶) on the handset, or press **CELL 1** or **CELL 2** on the telephone base to use the cell line.

Dial, edit or delete a directory entry

Edit a directory entry

You can edit any directory entry. However, be aware that if you download a directory from a cell phone again, the directory is erased and replaced with the current cell phone directory. If you have edited the downloaded entries on the **CLP99287/CLP99387/CLP99447/CLP99457/CLP99487/CLP99547/CLP99557/CLP99587**, those changes are lost. To avoid losing changes made to the downloaded directory, we suggest that you edit numbers in your cell phone, then download the directory.

Using a cordless handset:

1. Search for the desired entry in the directory (see **Review directory entries** and **3-character alphabetical search** on pages 91-92).
2. When a directory entry displays, press **EDIT**. The screen shows **Edit number** along with the phone number to be edited.
3. Use the dialing keys to edit the number:
 - Press **▼CID** or **▲DIR** to move the cursor to the left or right.
 - Press **MUTE/DELETE** or **BACKSP** to erase a digit.
 - Press and hold **MUTE/DELETE** to erase all digits.
 - Press and hold **REDIAL/PAUSE** to add a dialing pause (a **p** appears).
4. Press **NEXT**.
5. Press **▼CID** or **▲DIR** to highlight one of the following types.
 - Home
 - Cell
 - Work
 - Other
6. Press **NEXT**. The screen displays **Edit name**.
7. Use the dialing keys to edit the name.
 - Press **0** to add a space.
 - Press **▼CID** or **▲DIR** to move the cursor to the left or right.
 - Press **MUTE/DELETE** or **BACKSP** to erase a character.
 - Press and hold **MUTE/DELETE** to erase all characters.
8. Press **SAVE** to save the entry. There is a confirmation tone and the screen shows **Saved to directory**.

Dial, edit or delete a directory entry

Using the telephone base:

1. Search for the desired entry in the directory (see **Review directory entries** and **3-character alphabetical search** on pages 91-92).
2. When a directory entry displays, press **EDIT**. The screen shows **EDIT NUMBER** along with the phone number to be edited.
3. Use the dialing keys to edit the number:
 - Press **▼CALLER ID** or **▲DIRECTORY** to move the cursor to the left or right.
 - Press **X/DELETE** or **BACKSP** to erase a digit.
 - Press and hold **X/DELETE** to erase all digits.
 - Press and hold **REDIAL/PAUSE** to add a dialing pause (a **p** appears).
4. Press **NEXT**.
5. Press **▼CALLER ID** or **▲DIRECTORY** to highlight one of the following types.
 - Home
 - Cell
 - Work
 - Other
6. Press **NEXT**. The screen displays **EDIT NAME**.
7. Use the dialing keys to edit the name.
 - Press **0** to add a space.
 - Press **▼CALLER ID** or **▲DIRECTORY** to move the cursor to the left or right.
 - Press **X/DELETE** or **BACKSP** to erase a character.
 - Press and hold **X/DELETE** to erase all characters.
8. Press **SAVE** to save the entry. There is a confirmation tone and the screen shows **Saved to directory**.

Dial, edit or delete a directory entry

Edit the type of a directory entry

If you only want to edit the type of a directory entry:

1. Search for the desired entry in the directory (see **Review directory entries** and **3-character alphabetical search** on pages 91-92).
2. When a directory entry displays, press **LABEL**. Enter the corresponding shortcut keys shown on the screen.

-OR-

Press **CLEAR** to erase the assigned label.

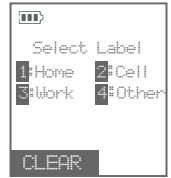

Delete a directory entry

To delete an entry:

1. Search for the desired entry in the directory (see **Review directory entries** and **3-character alphabetical search** on pages 91-92).
2. When the desired entry appears, press **MUTE/DELETE** on the handset or **X/DELETE** on the telephone base. The screen displays **Delete contact?** and the name of the entry. Press **YES** to confirm.
3. The screen displays **Contact deleted** and then the next alphabetical entry in the directory. You hear a confirmation tone.



Note: Once a directory entry is deleted, it cannot be retrieved.

Dial, edit or delete a directory entry

Remove a downloaded directory

Using a cordless handset:

1. Search for the desired downloaded directory in the directory menu (see **Review directory entries** and **3-character alphabetical search** on pages 91-92).
2. When the desired downloaded directory is chosen, press **OPTION**, then press **▼CID** or **▲DIR** to highlight **Remove dir**.
3. Press **SELECT**. The screen displays **Directory Cell Phone X will be erased** (**Cell Phone X** represents the device name of your cell phone).
4. Press **YES** to confirm. The handset displays **Erasing directory...** You hear a confirmation tone.

Using the telephone base:

1. Search for the desired downloaded directory in the directory menu (see **Review directory entries** and **3-character alphabetical search** on pages 91-92).
2. When the desired downloaded directory is chosen, press **OPTION**, then press **▼CALLER ID** or **▲DIRECTORY** to highlight **Remove dir**.
3. Press **SELECT**. The screen displays **Directory Cell Phone X will be erased**.
4. Press **YES** to confirm. You hear a confirmation tone.

About caller ID

This product supports caller ID services offered by most telephone service providers. Caller ID allows you to see the name, number, date and time of calls. The available caller ID information will appear after the first or second ring.

Information about caller ID with call waiting

Caller ID with call waiting lets you see the name and telephone number of the caller before answering the call, even while on another call.

It may be necessary to change your telephone service to use this feature. Contact your telephone service provider if:

- You have both caller ID and call waiting, but as separate services (you may need to combine these services).
- You have only caller ID service, or only call waiting service.
- You don't subscribe to caller ID or call waiting services.

There are fees for caller ID services. In addition, services may not be available in all areas.

This product can provide information only if both you and the caller are in areas offering caller ID service and if both telephone service providers use compatible equipment. The time and date, along with the call information, are from the telephone service provider.

Caller ID information may not be available for every incoming call. Callers may intentionally block their names and/or telephone numbers. You can only view a maximum of 15 digits of every caller ID log entry.



Note: You can use this product with regular caller ID service, or you can use this product's other features without subscribing to caller ID or combined caller ID with call waiting service.

Caller ID log

How the caller ID log works

The telephone stores caller ID information about the last 50 incoming calls in the telephone base. Entries are stored in reverse chronological order. The phone deletes the oldest entry when the log is full to make room for new calls. This information is common to the telephone base and all handsets, so changes made using any handset or the telephone base are reflected in all other devices. If you answer a call before the information appears on the screen, it does not show in the caller ID log.



Note: Each entry may have up to 24 digits for the phone number and 15 characters for the name.

Missed (new) call indicator

When a handset or the telephone base is in idle mode and has new or missed calls, its screen shows **XX Missed calls**.

All new and missed entries are counted as missed calls. Each time you review a new caller ID log entry (indicated by **NEW** on the screen), the missed calls message goes away. When there is a new unanswered call, the missed calls message displays again. The number of missed calls includes all new and missed entries that have not been reviewed.

If you do not want to review the missed calls one by one, but still want to keep them in the caller ID log, you can press and hold **OFF/CANCEL** on the handset for four seconds when the handset is idle, or press and hold **CANCEL** on the telephone base for four seconds when the telephone base is idle. You will hear a confirmation tone. All the entries in the caller ID log become old (reviewed already), and the missed calls message goes away.

Memory match

If the incoming telephone number matches the last 7 digits of a telephone number in your directory, the name that appears on the screen matches the corresponding name in your directory.

For example, if Christine Smith calls, her name appears as **Chris** if this is how you entered it into your directory.



Note: The number shown in the caller ID log will be in the format sent by the telephone service provider. The telephone service provider usually delivers ten-digit phone numbers (area code plus telephone number). If the telephone number of the caller does not match a number in your directory, the name will appear as it is delivered by the telephone service provider.

Caller ID operation

Review the caller ID log

Review the caller ID log to find out who called, to return the call, or to copy the caller's name and number into your directory. **Caller ID log empty** appears if there are no records in the caller ID log.

1. When the handset or the telephone base is in idle mode, press **▼CID** on the handset or **▼CALLER ID** on the telephone base to review the caller ID log in reverse chronological order starting with the most recent call.

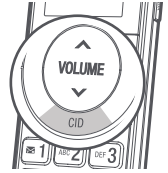

-OR-

Review the caller ID log by pressing **MENU**. Press **▼CID** or **▲DIR** on the handset or **▼CALLER ID** or **▲DIRECTORY** on the telephone base to scroll to **Caller ID log**, then press **SELECT** twice to select **Review**.

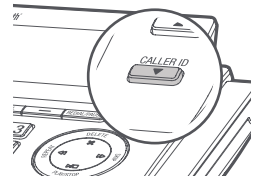

2. Press **▼CID** or **▲DIR** on the handset or **▼CALLER ID** or **▲DIRECTORY** on the telephone base to scroll through the list.



Note: Only one handset or the telephone base can review the caller ID log at a time. If another device tries to enter the directory or caller ID log, it shows **Not available at this time**.

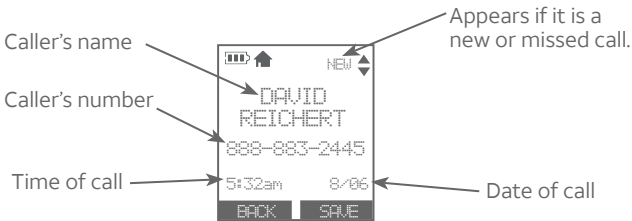

Caller ID operation

View dialing options

Although the incoming caller ID log entries have ten digits (the area code plus the seven-digit number), in some areas, you may need to dial only the 7 digits, 1 plus the seven digits, or 1 plus the area code plus the seven digits. You can change and store the number of digits that you dial in the caller ID log.

While reviewing the caller ID log, press **#** (pound key) repeatedly to show different dialing options for local and long distance numbers before dialing or saving the telephone number in the directory.

Press **1** repeatedly if you need to add or remove 1 in front of the telephone number before dialing or saving it in the directory.

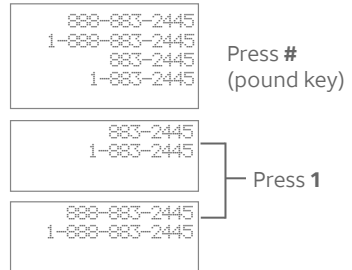

When the number is in the correct format for dialing, press **HOME/FLASH** or **)/SPEAKER** on the handset, or **HOME** on the telephone base to call the number using the home line.

-OR-

Press **CELL 1** or **CELL 2** on the handset or **CELL 1** or **CELL 2** on the telephone base to call the number using the cell line.

Dial a caller ID log entry

1. When in the caller ID log, press **▼CID** or **▲DIR** on the handset, or press **▼CALLER ID** or **▲DIRECTORY** on the telephone base to browse.
2. Press **HOME/FLASH** or **)/SPEAKER** on the handset, or **HOME** on the telephone base to dial the displayed entry using the home line.

-OR-

Press **CELL 1** or **CELL 2** on the handset or **CELL 1** or **CELL 2** on the telephone base to dial the display entry using the cell line.

Caller ID operation

Save a caller ID log entry to the directory

Caller ID log entries can only be saved to the **Home** directory.

Using a cordless handset:

1. Select a desired entry in the caller ID log (see **Review the caller ID log** on page 99).
2. When the desired entry appears, press **SAVE**.
3. Press **SELECT** to select **Directory**. The screen displays **Edit number**.
4. Use the dialing keys to edit the number.
 - Press **▼CID** or **▲DIR** to move the cursor to the left or right.
 - Press **MUTE/DELETE** or **BACKSP** to backspace and erase a digit.
 - Press and hold **MUTE/DELETE** to erase the entire entry.
 - Press and hold **REDIAL/PAUSE** to insert a dialing pause (a **p** appears).
5. Press **NEXT**.
6. Press **▼CID** or **▲DIR** to highlight one of the following types:
 - Home
 - Cell
 - Work
 - Other
7. Press **NEXT**. The handset displays **Edit name**.
8. Use the dialing keys (page 89) to edit the name.
 - Press **▼CID** or **▲DIR** to move the cursor to the left or right.
 - Press **0** to add a space.
 - Press **MUTE/DELETE** or **BACKSP** to erase a character.
 - Press and hold **MUTE/DELETE** to erase all characters.
 - Press **#** (pound key) to move the last word to the front. For example, **Johnson Charlie** becomes **Charlie Johnson** when you press **#** (pound key).
9. Press **SAVE** to confirm. The screen shows **Saved to directory**.

Caller ID operation

Using the telephone base:

1. Select a desired entry in the caller ID log (see **Review the caller ID log** on page 99).
2. When the desired entry appears, press **SAVE**.
3. Press **SELECT** to select **Directory**. The telephone base displays **EDIT NUMBER**.
4. Use the dialing keys to edit the number.
 - Press **▼CALLER ID** or **▲DIRECTORY** to move the cursor to the left or right.
 - Press **X/DELETE** or **BACKSP** to backspace and erase a digit.
 - Press and hold X/DELETE to erase the entire entry.
 - Press and hold REDIAL/PAUSE to insert a dialing pause (a **p** appears).
5. Press **NEXT**.
6. Press **▼CALLER ID** or **▲DIRECTORY** to highlight one of the following types:
 - Home
 - Cell
 - Work
 - Other
7. Press **NEXT**. The telephone base displays **EDIT NAME**.
8. Use the dialing keys (page 89) to edit the name.
 - Press **▼CALLER ID** or **▲DIRECTORY** to move the cursor to the left or right.
 - Press **0** to add a space.
 - Press **X/DELETE** or **BACKSP** to erase a character.
 - Press and hold X/DELETE to erase all characters.
 - Press **#** (pound key) to move the last word to the front. For example, **Johnson Charlie** becomes **Charlie Johnson** when you press **#** (pound key).
9. Press **SAVE** to confirm. The telephone base shows **Saved to directory**.



Notes:

- If the caller's name you received from the telephone service provider is all in capital letters, the first letter of every word remains a capital letter, while other letters become lower case. However, the next letter after the prefix "Mac", "Mc", "D", "C" or "O", is kept as a capital letter. For example, the "D" in "MacDonald" is kept as a capital letter. Another exception is that "VAN DER" will be changed to "Van der".
- If the telephone number from the caller ID information has already been saved in the directory under a different name, the new name will overwrite the old one.
- If you save a block number in the caller ID log to the directory, the original name from the caller ID information will be saved.

Caller ID operation

Save a caller ID log entry to the allow list

Using a cordless handset:

1. Select a desired entry in the caller ID log (see **Review the caller ID log** on page 99).
2. When the desired entry appears, press **SAVE**.
3. Press **▼CID** or **▲DIR** to highlight **Allow list**, and then press **SELECT**. The screen displays **Edit number**.
4. Use the dialing keys to edit the number.
 - ▶ Press **▼CID** or **▲DIR** to move the cursor to the left or right.
 - ▶ Press **MUTE/DELETE** or **BACKSP** to backspace and erase a digit.
 - ▶ Press and hold **MUTE/DELETE** to erase the entire entry.
 - ▶ Press and hold **REDIAL/PAUSE** to insert a dialing pause (a **p** appears).
5. Press **NEXT**. The handset displays **Edit name**.
6. Use the dialing keys (page 89) to edit the name.
 - ▶ Press **▼CID** or **▲DIR** to move the cursor to the left or right.
 - ▶ Press **0** to add a space.
 - ▶ Press **MUTE/DELETE** or **BACKSP** to erase a character.
 - ▶ Press and hold **MUTE/DELETE** to erase all characters.
 - ▶ Press **#** (pound key) to move the last word to the front. For example, **Johnson Charlie** becomes **Charlie Johnson** when you press **#** (pound key).
7. Press **SAVE** to confirm. The screen shows **Saved to allow list**.

Using the telephone base:

1. Select a desired entry in the caller ID log (see **Review the caller ID log** on page 99).
2. When the desired entry appears, press **SAVE**.
3. Press **▼CALLER ID** or **▲DIRECTORY** to highlight **Allow list**, and then press **SELECT**. The telephone base displays **EDIT NUMBER**.
4. Use the dialing keys to edit the number.
 - ▶ Press **▼CALLER ID** or **▲DIRECTORY** to move the cursor to the left or right.
 - ▶ Press **X/DELETE** or **BACKSP** to backspace and erase a digit.
 - ▶ Press and hold **X/DELETE** to erase the entire entry.
 - ▶ Press and hold **REDIAL/PAUSE** to insert a dialing pause (a **p** appears).

Caller ID operation

5. Press **NEXT**. The telephone base displays **EDIT NAME**.
6. Use the dialing keys (page 89) to edit the name.
 - Press **▼CALLER ID** or **▲DIRECTORY** to move the cursor to the left or right.
 - Press **0** to add a space.
 - Press **X/DELETE** or **BACKSP** to erase a character.
 - Press and hold **X/DELETE** to erase all characters.
 - Press **#** (pound key) to move the last word to the front. For example, **Johnson Charlie** becomes **Charlie Johnson** when you press **#** (pound key).
7. Press **SAVE** to confirm. The telephone base shows **Saved to allow list**.

Save a caller ID log entry to the block list

Using a cordless handset:

1. Select a desired entry in the caller ID log (see **Review the caller ID log** on page 99).
2. When the desired entry appears, press **SAVE**.
3. Press **▼CID** or **▲DIR** to highlight **Block list**, and then press **SELECT**. The screen displays **Edit number**.
4. Use the dialing keys to edit the number.
 - Press **▼CID** or **▲DIR** to move the cursor to the left or right.
 - Press **MUTE/DELETE** or **BACKSP** to backspace and erase a digit.
 - Press and hold **MUTE/DELETE** to erase the entire entry.
 - Press and hold **REDIAL/PAUSE** to insert a dialing pause (a **p** appears).
5. Press **NEXT**. The handset displays **Edit name**.
6. Use the dialing keys (page 89) to edit the name.
 - Press **▼CID** or **▲DIR** to move the cursor to the left or right.
 - Press **0** to add a space.
 - Press **MUTE/DELETE** or **BACKSP** to erase a character.
 - Press and hold **MUTE/DELETE** to erase all characters.
 - Press **#** (pound key) to move the last word to the front. For example, **Johnson Charlie** becomes **Charlie Johnson** when you press **#** (pound key).
7. Press **SAVE** to confirm. The screen shows **Saved to block list**.

Caller ID operation

Using the telephone base:

1. Select a desired entry in the caller ID log (see **Review the caller ID log** on page 99).
2. When the desired entry appears, press **SAVE**.
3. Press **▼CALLER ID** or **▲DIRECTORY** to highlight **Block list**, and then press **SELECT**. The telephone base displays **EDIT NUMBER**.
4. Use the dialing keys to edit the number.
 - Press **▼CALLER ID** or **▲DIRECTORY** to move the cursor to the left or right.
 - Press **X/DELETE** or **BACKSP** to backspace and erase a digit.
 - Press and hold **X/DELETE** to erase the entire entry.
 - Press and hold **REDIAL/PAUSE** to insert a dialing pause (a **p** appears).
5. Press **NEXT**. The telephone base displays **EDIT NAME**.
6. Use the dialing keys (page 89) to edit the name.
 - Press **▼CALLER ID** or **▲DIRECTORY** to move the cursor to the left or right.
 - Press **0** to add a space.
 - Press **X/DELETE** or **BACKSP** to erase a character.
 - Press and hold **X/DELETE** to erase all characters.
 - Press **#** (pound key) to move the last word to the front. For example, **Johnson Charlie** becomes **Charlie Johnson** when you press **#** (pound key).
7. Press **SAVE** to confirm. The telephone base shows **Saved to block list**.

Save a caller ID log entry to the star name list

Using a cordless handset:

1. Select a desired entry in the caller ID log (see **Review the caller ID log** on page 99).
2. When the desired entry appears, press **SAVE**.
3. Press **▼CID** or **▲DIR** to highlight **Star name list**, and then press **SELECT**. The screen displays **Star this name?** and then the caller's name.
4. Press **SELECT** to confirm. The screen shows **Saved to star name list**.



Caller ID operation

Using the telephone base:

1. Select a desired entry in the caller ID log (see **Review the caller ID log** on page 99).
2. When the desired entry appears, press **SAVE**.
3. Press **▼CALLER ID** or **▲DIRECTORY** to highlight **Star name list**, and then press **SELECT**. The telephone base displays **Star this name?** and then the caller's name.
4. Press **SELECT** to confirm. The telephone base shows **Saved to star name list**.

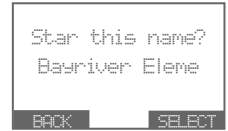

Delete caller ID log entries

To delete an entry:

Press **MUTE/DELETE** on the handset or **X/DELETE** on the telephone base to delete the shown entry.

To delete all entries:

1. Press **MENU** when in idle mode.
2. Press **▼CID** or **▲DIR** on the handset, or press **▼CALLER ID** or **▲DIRECTORY** on the telephone base to scroll to **Caller ID log**, then press **SELECT**.
3. Press **▼CID** or **▲DIR** on the handset, or press **▼CALLER ID** or **▲DIRECTORY** on the telephone base to scroll to **Del all calls**, then press **SELECT**.
4. When the screen shows **Delete all calls?**, press **YES** to confirm. There is a confirmation tone and the screen returns to the previous menu.

Reasons for missing caller ID information

There are occasions when other information or no information shows for various reasons:

On-screen message	Reason
PRIVATE NUMBER	The caller prefers not to show the phone number.
PRIVATE NAME	The caller prefers not to show the name.
PRIVATE CALLER	The caller prefers not to show the phone number and name.
UNKNOWN NUMBER	Your telephone service provider cannot determine the caller's number.
UNKNOWN NAME	Your telephone service provider cannot determine the caller's name.
UNKNOWN CALLER	Your telephone service provider cannot determine the caller's name and telephone number. Calls from other countries may also generate this message.

About Smart call blocker*

If you have subscribed to caller ID service, then you can use Smart call blocker to screen robocalls, telemarketing calls and unwanted calls for you, while allowing welcome calls to get through.†

† The screening feature of Smart call blocker is applicable to home calls only. All incoming cell calls will get through and ring.

You can set up your lists of welcome callers and unwelcome callers. Smart call blocker allows calls from your welcome callers to get through, and it blocks calls from your unwelcome callers.

For other unknown home calls, you can allow these calls, block these calls, or forward these calls to the answering system.

With some easy configurations, you can set to only filter robocalls on the home line by asking the callers to press the pound key (#) before the calls are put through to you.

You can also set Smart call blocker to screen incoming home calls by asking the callers to record their names and press the pound key (#). After your caller completes the request, your telephone rings and announces the caller's name. You can then choose to block or answer the call, or you can forward the call to the answering system. If the caller does not respond or record his/her name, the call is blocked from ringing through. When you add your welcome callers to your allow list, they will bypass all screening and ring directly to your handsets.



Notes:

- ▶ Smart call blocker is on, once you install your telephone. It allows all incoming calls to get through and ring by default. You can change the Smart call blocker settings to screen incoming home calls. For more details, see **Control home calls without numbers** on page 112 and **Control uncategorized home calls** on page 114.
- ▶ With call screening active, Smart call blocker screens and filters incoming home calls from numbers or names that are not yet saved in your directory, allow list, block list, or star name list. You can easily add incoming phone numbers to your allow list and block list. This allows you to build up your lists of allowed and blocked numbers, and Smart call blocker will know how to deal with these calls when they come in again.
- ▶ To turn off Smart call blocker, see **Set Smart call blocker on/off** on page 112.

* Includes licenced Qaltele™ technology.

Qaltele™ is a trademark of Truecall Group Limited.

About Smart call blocker

Call categories

Calls are classified into four categories:

Welcome calls

Welcome calls are calls with telephone numbers saved in your allow list or directory, and not in your block list. Welcome calls also include calls with caller names saved in your star name list.



Notes:

- ▶ All incoming calls on your cell lines will get through and ring, unless the caller's numbers are saved in your block list. If you want to block a cell call, add the number to the block list. See **Block list** on page 116.
- ▶ There are many organizations like schools, medical offices, and pharmacies that use robocalls to communicate important information to you. Robocall uses an autodialer to deliver pre-recorded messages. By entering the name of the organizations into the star name list, it ensures these calls will ring through when you only know the caller names but not their numbers.

Unwelcome calls

Unwelcome calls are calls with telephone numbers saved in your block list, and you want to block their calls.

Calls without numbers (for home calls only)

Calls without numbers are calls that are “out of area” or with numbers set to “Private”.

Uncategorized calls (for home calls only)

Uncategorized calls include calls with absent caller ID number, calls with numbers that are not in your directory, allow list, or block list, or calls with caller ID names that are not in your star name list.



Note: The allow list stores up to 200 entries, the block list stores up to 1,000 entries, and the star name list stores up to 10 names.

About Smart call blocker

Call controls

- Smart call blocker is set to on, and to allow all incoming calls by default. When Smart call blocker is on, the first ring of all incoming calls will be muted.
- If your directory, allow list, star name list and block list are empty when Smart call blocker is on, and you have set to screen calls, the telephone will screen all incoming home calls and asks callers to announce their names or press the pound key (#).
- If Smart call blocker is off, all incoming calls ring, including numbers saved in the block list.
- If **QUIET** mode is on, and Smart call blocker is on and in screening mode, all screened home calls will be sent to the answering system after screening.

Smart call blocker handles calls in the following ways:

Call category	Call control
Welcome calls	Allow The telephone rings when there is an incoming call with number saved in your allow list or directory, but not in your block list. Robocalls with caller names saved in your star name list will also ring.
Unwelcome calls	Block The telephone does not ring when there is an incoming call with number saved in your block list, and the call will be rejected.

About Smart call blocker

Call category	Call control
<p>Calls without numbers (for home calls only)</p> <ul style="list-style-type: none"> You can set to screen, allow, or block all calls of this call category, or to send these calls to the answering system. Allow is the default setting. To change the setting, see Control home calls without numbers on page 112. 	<p>Screening with caller name</p> <p>If you have selected this option, the telephone plays the screening announcement, and then asks the caller to say his/her name before the call rings on your telephone. You will then hear the caller's name announced if you have turned on the caller ID announce feature. Then, you can decide whether to accept or reject the call, or to forward the call to the answering system.</p> <p>Screening without caller name</p> <p>If you have selected this option, the telephone plays the screening announcement, and then asks the caller to press the pound key (#) before the call rings on your telephone. You can then answer the call.</p> <p>Allow (default settings)</p> <p>The telephone allows the calls to get through and ring. The caller's number will not be saved to the allow list.</p> <p>Answering system</p> <p>If you have selected this option, the telephone forwards the calls to the answering system without ringing.</p> <p>Block</p> <p>If you have selected this option, the telephone rejects the calls with block announcement without ringing. The caller's number will not be saved to the block list.</p>
<p>Uncategorized calls (for home calls only)</p> <ul style="list-style-type: none"> You can set to screen, allow, or block all calls of this call category, or to send these calls to the answering system. Allow is the default setting. To change the setting, see Control uncategorized home calls on page 114. 	

Call block settings

Set Smart call blocker on/off

The Smart call blocker feature is set to on by default.

Using a cordless handset:

1. Press **MENU** on the handset in idle mode to enter the main menu.
2. Press **▼CID** or **▲DIR** to scroll to **Smart call blk**, then press **SELECT**.
3. Press **SELECT** again to choose **SCB On/Off**.
4. Press **▼CID** or **▲DIR** to scroll to **On** or **Off**, and then press **SELECT**.



Using the telephone base:

1. Press **MENU** on the telephone base in idle mode to enter the main menu.
2. Press **▼CALLER ID** or **▲DIRECTORY** to scroll to **Smart call blk**, then press **SELECT**.
3. Press **SELECT** again to choose **SCB On/Off**.
4. Press **▼CALLER ID** or **▲DIRECTORY** to scroll to **On** or **Off**, and then press **SELECT**.



Control home calls without numbers

Use this setting to control “out of area” or “Private” home calls. You can choose to allow or reject these calls directly. You can also choose to screen them with or without learning the callers’ names before you decide whether to answer or reject these calls. Moreover, you can forward these calls to the answering system.

To change the setting:

Using a cordless handset:

1. Press **MENU** on the handset in idle mode to enter the main menu.
2. Press **▼CID** or **▲DIR** to scroll to **Smart call blk**, then press **SELECT**.



Call block settings

3. Press **▼CID** or **▲DIR** to scroll to **Calls w/o num**, then press **SELECT**.



4. Press **▼CID** or **▲DIR** to scroll to one of the following options, then press **SELECT**.

- **Screening** - ask the caller to press the pound key (#) or to say his/her name before the call rings on your telephone.
- **Allow** - allow the calls to get through and ring.
- **Answering sys** - forward the calls to the answering system without ringing.
- **Block** - reject the calls with block announcement.



5. If you select **Screening**, press **▼CID** or **▲DIR** to choose one of the following options, then press **SELECT**.

- **w/ Caller name** - ask the caller to say his/her name before the call rings on your telephone. You will then hear the caller's name announced if you have turned on the caller ID announce feature. Then, you can decide whether to answer or reject the call, or to forward the call to the answering system.
- **w/o Caller name** - ask the caller to press the pound key (#) before the call rings on your telephone. You can then answer the call.



Using the telephone base:

1. Press **MENU** on the handset in idle mode to enter the main menu.
2. Press **▼CALLER ID** or **▲DIRECTORY** to scroll to **Smart call blk**, then press **SELECT**.
3. Press **▼CALLER ID** or **▲DIRECTORY** to scroll to **Calls w/o num**, then press **SELECT**.
4. Press **▼CALLER ID** or **▲DIRECTORY** to scroll to one of the following options, then press **SELECT**.



- **Screening** - ask the caller to press the pound key (#) or to say his/her name before the call rings on your telephone.
- **Allow** - allow the calls to get through and ring.

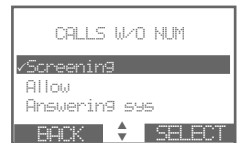

Call block settings

- ▶ **Answering sys** - forward the calls to the answering system without ringing.
 - ▶ **Block** - reject the calls with block announcement.
5. If you select **Screening**, press ▼ **CALLER ID** or ▲ **DIRECTORY** to choose one of the following options, then press **SELECT**.
- ▶ **w/ Caller name** - ask the caller to say his/her name before the call rings on your telephone. You will then hear the caller's name announced if you have turned on the caller ID announce feature. Then, you can decide whether to answer or reject the call, or to forward the call to the answering system.
 - ▶ **w/o Caller name** - ask the caller to press the pound key (#) before the call rings on your telephone. You can then answer the call.



Control uncategorized home calls

Use this setting to control home calls with numbers that are not in your directory, allow list or block list, or have no caller ID number display. You can choose to allow or reject these calls directly. You can also choose to screen them with or without learning the callers' names before you decide whether to answer or reject these calls. Moreover, you can forward these calls to the answering system.

To change the setting:

Using a cordless handset:

1. Press **MENU** on the handset in idle mode to enter the main menu.
2. Press ▼ **CID** or ▲ **DIR** to scroll to **Smart call blk**, then press **SELECT**.
3. Press ▼ **CID** or ▲ **DIR** to scroll to **Uncategorized**, then press **SELECT**.
4. Press ▼ **CID** or ▲ **DIR** to scroll to one of the following options, then press **SELECT**.
 - ▶ **Screening** - ask the caller to press the pound key (#) or to say his/her name before the call rings on your telephone.
 - ▶ **Allow** - allow the calls to get through and ring.
 - ▶ **Answering sys** - forward the calls to the answering system without ringing.



Call block settings

- **Block** - reject the calls with block announcement.
5. If you select **Screening**, press ▼**CID** or ▲**DIR** to choose one of the following options, then press **SELECT**.
- **w/ Caller name** - ask the caller to say his/her name before the call rings on your telephone. You will then hear the caller's name announced if you have turned on the caller ID announce feature. Then, you can decide whether to answer or reject the call, or to forward the call to the answering system.
 - **w/o Caller name** - ask the caller to press the pound key (#) before the call rings on your telephone. You can then answer the call.



Using the telephone base:

1. Press **MENU** on the telephone base in idle mode to enter the main menu.
2. Press ▼**CALLER ID** or ▲**DIRECTORY** to scroll to **Smart call blk**, then press **SELECT**.
3. Press ▼**CALLER ID** or ▲**DIRECTORY** to scroll to **Uncategorized**, then press **SELECT**.
4. Press ▼**CALLER ID** or ▲**DIRECTORY** to scroll to one of the following options, then press **SELECT**.
 - **Screening** - ask the caller to press the pound key (#) or to say his/her name before the call rings on your telephone.
 - **Allow** - allow the calls to get through and ring.
 - **Answering sys** - forward the calls to the answering system without ringing.
 - **Block** - reject the calls with block announcement.
5. If you select **Screening**, press ▼**CALLER ID** or ▲**DIRECTORY** to choose one of the following options, then press **SELECT**.
 - **w/ Caller name** - ask the caller to say his/her name before the call rings on your telephone. You will then hear the caller's name announced if you have turned on the caller ID announce feature. Then, you can decide whether to answer or reject the call, or to forward the call to the answering system.



Call block settings

- **w/o Caller name** - ask the caller to press the pound key (#) before the call rings on your telephone. You can then answer the call.



Note: Robocalls will be classified as uncategorized calls. If you select **Screening**, the telephone screens and filters these calls. It asks the caller to press the pound key (#) or announces his/her name before putting the call through to you. There may be robocalls that you do not want to miss. For example, robocalls with announcements or notices from schools or pharmacies. You can set up your star name list with these caller names to allow their calls to get through to you. See **Star name list** on page 128.

Block list

Add numbers that you want to prevent their calls from ringing through. The block list stores up to 1,000 entries.



Note: Home or cell calls with numbers that have been added to your block list will be blocked.

Add a block entry:

Using a cordless handset:

1. Press **MENU** on the handset in idle mode to enter the main menu.
2. Press **▼CID** or **▲DIR** to scroll to **Smart call blk**, then press **SELECT**.
3. Press **▼CID** or **▲DIR** to scroll to **Block list**, then press **SELECT**.
4. Press **▼CID** or **▲DIR** to scroll to **Add new entry**, then press **SELECT**.
5. When the screen displays **Enter number**, use the dialing keys to enter a number (up to 30 digits).
 - Press **▼CID** or **▲DIR** to move the cursor to the left or right.
 - Press **MUTE/DELETE** to erase a digit.
 - Press and hold **MUTE/DELETE** to erase all digits.
 - Press and hold **REDIAL/PAUSE** to enter a three-second dialing pause (a **p** appears).

-OR-

Copy a number from the redial list by pressing **REDIAL/PAUSE**. Then, press **▼CID**, **▲DIR** or **REDIAL/PAUSE** repeatedly to find the desired number. Press **INSERT** to copy the number.

6. Press **NEXT** to move on to the name.
7. When the screen displays **Enter name**, use the dialing keys to enter a name (up to 15 characters). Press a key repeatedly until the desired character appears. The first character of every word is capitalized.
 - Press **▼CID** or **▲DIR** to move the cursor to the left or right.
 - Press **0** to add a space.



Call block settings

- Press **MUTE/DELETE** to erase a character.
 - Press and hold **MUTE/DELETE** to erase all characters.
 - Press **-tone X** to change the next letter to upper or lower case.
8. Press **SAVE** to store your block entry.

Using the telephone base:

1. Press **MENU** on the telephone base in idle mode to enter the main menu.
2. Press **▼CALLER ID** or **▲DIRECTORY** to scroll to **Smart call blk**, then press **SELECT**.
3. Press **▼CALLER ID** or **▲DIRECTORY** to scroll to **Block list**, then press **SELECT**.
4. Press **▼CALLER ID** or **▲DIRECTORY** to scroll to **Add new entry**, then press **SELECT**.
5. When the screen displays **ENTER NUMBER**, use the dialing keys to enter a number (up to 30 digits).
 - Press **▼CALLER ID** or **▲DIRECTORY** to move the cursor to the left or right.
 - Press **X/DELETE** to erase a digit.
 - Press and hold **X/DELETE** to erase all digits.
 - Press and hold **REDIAL/PAUSE** to enter a three-second dialing pause (a **p** appears).

-OR-

Copy a number from the redial list by pressing **REDIAL/PAUSE**. Then, press **▼CALLER ID**, **▲DIRECTORY** or **REDIAL/PAUSE** repeatedly to find the desired number. Press **INSERT** to copy the number.

6. Press **NEXT** to move on to the name.
7. When the screen displays **ENTER NAME**, use the dialing keys to enter a name (up to 15 characters). Press a key repeatedly until the desired character appears. The first character of every word is capitalized.
 - Press **▼CALLER ID** or **▲DIRECTORY** to move the cursor to the left or right.
 - Press **0** to add a space.
 - Press **X/DELETE** to erase a character.
 - Press and hold **X/DELETE** to erase all characters.
 - Press **-tone X** to change the next letter to upper or lower case.
8. Press **SAVE** to store your block entry.



Notes:

- Numbers saved in your directory can also be saved to the block list.
- If you save a block entry that has already been saved to the allow list, the entry in the allow list will be removed.

Call block settings

Review block list:

Using a cordless handset or the telephone base:

1. Press **MENU** in idle mode to enter the main menu.
2. Press **▼CID** or **▲DIR** on the handset, or press **▼CALLER ID** or **▲DIRECTORY** on the telephone base to scroll to **Smart call blk**, then press **SELECT**.
3. Press **▼CID** or **▲DIR** on the handset, or press **▼CALLER ID** or **▲DIRECTORY** on the telephone base to scroll to **Block list**, then press **SELECT** twice.
4. Press **▼CID** or **▲DIR** on the handset, or press **▼CALLER ID** or **▲DIRECTORY** on the telephone base to browse through the block entries.



Note: **Block list is empty** appears if there are no block entries.

Save a caller ID log entry to block list:

Using a cordless handset:

1. Select a desired entry in the caller ID log (see **Review the caller ID log** on 99).
2. When the desired entry appears, press **SAVE**.
3. Press **▼CID** or **▲DIR** to highlight **Block list**, and then press **SELECT**. The screen displays **Edit number**.
4. Use the dialing keys to edit the number.
 - ▶ Press **▼CID** or **▲DIR** to move the cursor to the left or right.
 - ▶ Press **MUTE/DELETE** or **BACKSP** to backspace and erase a digit.
 - ▶ Press and hold **MUTE/DELETE** to erase the entire entry.
 - ▶ Press and hold **REDIAL/PAUSE** to insert a dialing pause (a **p** appears).
5. Press **NEXT**. The handset displays **Edit name**.
6. Use the dialing keys (page 89) to edit the name.
 - ▶ Press **▼CID** or **▲DIR** to move the cursor to the left or right.
 - ▶ Press **0** to add a space.
 - ▶ Press **MUTE/DELETE** or **BACKSP** to erase a character.
 - ▶ Press and hold **MUTE/DELETE** to erase all characters.

Call block settings

- ▶ Press **#** (pound key) to move the last word to the front. For example, **Johnson Charlie** becomes **Charlie Johnson** when you press **#** (pound key).
7. Press **SAVE** to confirm. The screen shows **Saved to block list**.

Using the telephone base:

1. Select a desired entry in the caller ID log (see **Review the caller ID log** on page 99).
2. When the desired entry appears, press **SAVE**.
3. Press **▼CALLER ID** or **▲DIRECTORY** to highlight **Block list**, and then press **SELECT**. The telephone base displays **EDIT NUMBER**.
4. Use the dialing keys to edit the number.
 - ▶ Press **▼CALLER ID** or **▲DIRECTORY** to move the cursor to the left or right.
 - ▶ Press **X/DELETE** or **BACKSP** to backspace and erase a digit.
 - ▶ Press and hold **X/DELETE** to erase the entire entry.
 - ▶ Press and hold **REDIAL/PAUSE** to insert a dialing pause (a **p** appears).
5. Press **NEXT**. The telephone base displays **EDIT NAME**.
6. Use the dialing keys (page 89) to edit the name.
 - ▶ Press **▼CALLER ID** or **▲DIRECTORY** to move the cursor to the left or right.
 - ▶ Press **0** to add a space.
 - ▶ Press **X/DELETE** or **BACKSP** to erase a character.
 - ▶ Press and hold **X/DELETE** to erase all characters.
 - ▶ Press **#** (pound key) to move the last word to the front. For example, **Johnson Charlie** becomes **Charlie Johnson** when you press **#** (pound key).
7. Press **SAVE** to confirm. The telephone base shows **Saved to block list**.

Edit a block entry:

Using a cordless handset:

1. Search for the desired entry in the block list (see **Review block list** on page 116).
2. When the desired entry displays, press **EDIT**. The screen displays **Edit number** along with the phone number to be edited. If you only want to edit the name, skip to Step 4.

Call block settings

3. To edit the number:
 - Use the dialing keys to enter digits.
 - Press **▼CID** or **▲DIR** to move the cursor to the left or right.
 - Press **MUTE/DELETE** or **BACKSP** to backspace and erase a digit.
 - Press and hold **MUTE/DELETE** to erase the entire entry.
 - Press and hold **REDIAL/PAUSE** to insert a dialing pause (a **p** appears).
4. Press **NEXT** to move on to the name. The screen displays **Edit name** along with the name to be edited.
5. To edit the name:
 - Use the dialing keys to enter characters.
 - Press **▼CID** or **▲DIR** to move the cursor to the left or right.
 - Press **0** to add a space.
 - Press **MUTE/DELETE** to erase a character.
 - Press and hold **MUTE/DELETE** to erase all characters.
 - Press **-tone X** to change the next letter to upper or lower case.
6. Press **SAVE** to confirm. The screen shows **Saved to block list**.

Using the telephone base:

1. Search for the desired entry in the block list (see **Review block list** on page 116).
2. When the desired entry displays, press **EDIT**. The screen displays **EDIT NUMBER** along with the phone number to be edited. If you only want to edit the name, skip to Step 4.
3. To edit the number:
 - Use the dialing keys to enter digits.
 - Press **▼CALLER ID** or **▲DIRECTORY** to move the cursor to the left or right.
 - Press **X/DELETE** or **BACKSP** to backspace and erase a digit.
 - Press and hold **X/DELETE** to erase the entire entry.
 - Press and hold **REDIAL/PAUSE** to insert a dialing pause (a **p** appears).
4. Press **NEXT** to move on to the name. The screen displays **EDIT NAME** along with the name to be edited.

Call block settings

5. To edit the name:

- Use the dialing keys to enter characters.
- Press **▼CALLER ID** or **▲DIRECTORY** to move the cursor to the left or right.
- Press **0** to add a space.
- Press **X/DELETE** to erase a character.
- Press and hold **X/DELETE** to erase all characters.
- Press **TONE ✕** to change the next letter to upper or lower case.

6. Press **SAVE** to confirm. The screen shows **Saved to block list**.

Delete a block entry:

Using a cordless handset or the telephone base:

1. Search for the desired entry in the block list (see **Review block list** on page 116).
2. When the desired entry displays, press **MUTE/DELETE** on the handset or **X/DELETE** on the telephone base. The screen shows **Delete entry?**
3. Press **YES** to confirm. The screen show **Entry deleted**, and the next entry displays. You cannot retrieve a deleted entry.



Note: If the call block list is empty after an entry is deleted, the screen displays **Block list is empty**.

Delete all block list entries:

Using a cordless handset or the telephone base:

1. Press **MENU** in idle mode to enter the main menu.
2. Press **▼CID** or **▲DIR** on the handset, or press **▼CALLER ID** or **▲DIRECTORY** on the telephone base to scroll to **Smart call blk**, then press **SELECT**.
3. Press **▼CID** or **▲DIR** on the handset, or press **▼CALLER ID** or **▲DIRECTORY** on the telephone base to scroll to **Block list**, then press **SELECT**.
4. Press **▼CID** or **▲DIR** on the handset, or press **▼CALLER ID** or **▲DIRECTORY** on the telephone base to scroll to **Delete all**, then press **SELECT**. The screen shows **Delete all in block list?**
5. Press **YES** to confirm. The screen displays **Deleted**. There is a confirmation tone.

Call block settings

Allow list

Add numbers that you want to allow their calls to get through to you. The allow list stores up to 200 entries.

Add an allow entry:

Using a cordless handset:

1. Press **MENU** on the handset in idle mode to enter the main menu.
2. Press **▼CID** or **▲DIR** to scroll to **Smart call blk**, then press **SELECT**.
3. Press **▼CID** or **▲DIR** to scroll to **Allow list**, then press **SELECT**.
4. Press **▼CID** or **▲DIR** to scroll to **Add new entry**, then press **SELECT**.
5. When the screen displays **Enter number**, use the dialing keys to enter a number (up to 30 digits).
 - ▶ Press **▼CID** or **▲DIR** to move the cursor to the left or right.
 - ▶ Press **MUTE/DELETE** to erase a digit.
 - ▶ Press and hold **MUTE/DELETE** to erase all digits.
 - ▶ Press and hold **REDIAL/PAUSE** to enter a three-second dialing pause (a **p** appears).

-OR-

Copy a number from the redial list by pressing **REDIAL/PAUSE**. Then, press **▼CID**, **▲DIR** or **REDIAL/PAUSE** repeatedly to find the desired number. Press **INSERT** to copy the number.

6. Press **NEXT** to move on to the name.
7. When the screen displays **Enter name**, use the dialing keys to enter a name (up to 15 characters). Press a key repeatedly until the desired character appears. The first character of every word is capitalized.
 - ▶ Press **▼CID** or **▲DIR** to move the cursor to the left or right.
 - ▶ Press **0** to add a space.
 - ▶ Press **MUTE/DELETE** to erase a character.
 - ▶ Press and hold **MUTE/DELETE** to erase all characters.
 - ▶ Press **-tone ✕** to change the next letter to upper or lower case.
8. Press **SAVE** to store your allow entry.



Call block settings

Using the telephone base:

1. Press **MENU** on the telephone base in idle mode to enter the main menu.
2. Press **▼CALLER ID** or **▲DIRECTORY** to scroll to **Smart call blk**, then press **SELECT**.
3. Press **▼CALLER ID** or **▲DIRECTORY** to scroll to **Allow list**, then press **SELECT**.
4. Press **▼CALLER ID** or **▲DIRECTORY** to scroll to **Add new entry**, then press **SELECT**.
5. When the screen displays **ENTER NUMBER**, use the dialing keys to enter a number (up to 30 digits).
 - Press **▼CALLER ID** or **▲DIRECTORY** to move the cursor to the left or right.
 - Press **X/DELETE** to erase a digit.
 - Press and hold **X/DELETE** to erase all digits.
 - Press and hold **REDIAL/PAUSE** to enter a three-second dialing pause (a **p** appears).

-OR-

Copy a number from the redial list by pressing **REDIAL/PAUSE**. Then, press **▼CALLER ID**, **▲DIRECTORY** or **REDIAL/PAUSE** repeatedly to find the desired number. Press **INSERT** to copy the number.

6. Press **NEXT** to move on to the name.
7. When the screen displays **ENTER NAME**, use the dialing keys to enter a name (up to 15 characters). Press a key repeatedly until the desired character appears. The first character of every word is capitalized.
 - Press **▼CALLER ID** or **▲DIRECTORY** to move the cursor to the left or right.
 - Press **0** to add a space.
 - Press **X/DELETE** to erase a character.
 - Press and hold **X/DELETE** to erase all characters.
 - Press **-tone X** to change the next letter to upper or lower case.
8. Press **SAVE** to store your allow entry.



Notes:

- Numbers saved in your directory can also be saved to the allow list.
- If you save an allow list entry that has already been saved to the block list, the entry in the block list will be removed.

Call block settings

Review allow list:

Using a cordless handset or the telephone base:

1. Press **MENU** in idle mode to enter the main menu.
2. Press **▼CID** or **▲DIR** on the handset, or press **▼CALLER ID** or **▲DIRECTORY** on the telephone base to scroll to **Smart call blk**, then press **SELECT**.
3. Press **▼CID** or **▲DIR** on the handset, or press **▼CALLER ID** or **▲DIRECTORY** on the telephone base to scroll to **Allow list**, then press **SELECT** twice.
4. Press **▼CID** or **▲DIR** on the handset, or press **▼CALLER ID** or **▲DIRECTORY** on the telephone base to browse through the allow entries.



Note: **Allow list is empty** appears if there are no allow entries.

Save a caller ID log entry to allow list:

Using a cordless handset:

1. Select a desired entry in the caller ID log (see **Review the caller ID log** on 99).
2. When the desired entry appears, press **SAVE**.
3. Press **▼CID** or **▲DIR** to highlight **Allow list**, and then press **SELECT**. The screen displays **Edit number**.
4. Use the dialing keys to edit the number.
 - ▶ Press **▼CID** or **▲DIR** to move the cursor to the left or right.
 - ▶ Press **MUTE/DELETE** or **BACKSP** to backspace and erase a digit.
 - ▶ Press and hold **MUTE/DELETE** to erase the entire entry.
 - ▶ Press and hold **REDIAL/PAUSE** to insert a dialing pause (a **p** appears).
5. Press **NEXT**. The handset displays **Edit name**.
6. Use the dialing keys (page 89) to edit the name.
 - ▶ Press **▼CID** or **▲DIR** to move the cursor to the left or right.
 - ▶ Press **0** to add a space.
 - ▶ Press **MUTE/DELETE** or **BACKSP** to erase a character.
 - ▶ Press and hold **MUTE/DELETE** to erase all characters.

Call block settings

- ▶ Press **#** (pound key) to move the last word to the front. For example, **Johnson Charlie** becomes **Charlie Johnson** when you press **#** (pound key).
7. Press **SAVE** to confirm. The screen shows **Saved to allow list**.

Using the telephone base:

1. Select a desired entry in the caller ID log (see **Review the caller ID log** on page 99).
2. When the desired entry appears, press **SAVE**.
3. Press **▼CALLER ID** or **▲DIRECTORY** to highlight **Allow list**, and then press **SELECT**. The telephone base displays **EDIT NUMBER**.
4. Use the dialing keys to edit the number.
 - ▶ Press **▼CALLER ID** or **▲DIRECTORY** to move the cursor to the left or right.
 - ▶ Press **X/DELETE** or **BACKSP** to backspace and erase a digit.
 - ▶ Press and hold **X/DELETE** to erase the entire entry.
 - ▶ Press and hold **REDIAL/PAUSE** to insert a dialing pause (a **p** appears).
5. Press **NEXT**. The telephone base displays **EDIT NAME**.
6. Use the dialing keys (page 89) to edit the name.
 - ▶ Press **▼CALLER ID** or **▲DIRECTORY** to move the cursor to the left or right.
 - ▶ Press **0** to add a space.
 - ▶ Press **X/DELETE** or **BACKSP** to erase a character.
 - ▶ Press and hold **X/DELETE** to erase all characters.
 - ▶ Press **#** (pound key) to move the last word to the front. For example, **Johnson Charlie** becomes **Charlie Johnson** when you press **#** (pound key).
7. Press **SAVE** to confirm. The telephone base shows **Saved to allow list**.

Edit an allow entry:

Using a cordless handset:

1. Search for the desired entry in the block list (see **Review allow list** on page 124).
2. When the desired entry displays, press **EDIT**. The screen displays **Edit number** along with the phone number to be edited. If you only want to edit the name, skip to Step 4.

Call block settings

3. To edit the number:
 - Use the dialing keys to enter digits.
 - Press **▼CID** or **▲DIR** to move the cursor to the left or right.
 - Press **MUTE/DELETE** or **BACKSP** to backspace and erase a digit.
 - Press and hold **MUTE/DELETE** to erase the entire entry.
 - Press and hold **REDIAL/PAUSE** to insert a dialing pause (a **p** appears).
4. Press **NEXT** to move on to the name. The screen displays **Edit name** along with the name to be edited.
5. To edit the name:
 - Use the dialing keys to enter characters.
 - Press **▼CID** or **▲DIR** to move the cursor to the left or right.
 - Press **0** to add a space.
 - Press **MUTE/DELETE** to erase a character.
 - Press and hold **MUTE/DELETE** to erase all characters.
 - Press **-tone X** to change the next letter to upper or lower case.
6. Press **SAVE** to confirm. The screen shows **Saved to allow list**.

Using the telephone base:

1. Search for the desired entry in the block list (see **Review allow list** on page 124).
2. When the desired entry displays, press **EDIT**. The screen displays **EDIT NUMBER** along with the phone number to be edited. If you only want to edit the name, skip to Step 4.
3. To edit the number:
 - Use the dialing keys to enter digits.
 - Press **▼CALLER ID** or **▲DIRECTORY** to move the cursor to the left or right.
 - Press **X/DELETE** or **BACKSP** to backspace and erase a digit.
 - Press and hold **X/DELETE** to erase the entire entry.
 - Press and hold **REDIAL/PAUSE** to insert a dialing pause (a **p** appears).
4. Press **NEXT** to move on to the name. The screen displays **EDIT NAME** along with the name to be edited.

Call block settings

- To edit the name:
 - Use the dialing keys to enter characters.
 - Press **▼CALLER ID** or **▲DIRECTORY** to move the cursor to the left or right.
 - Press **0** to add a space.
 - Press **X/DELETE** to erase a character.
 - Press and hold **X/DELETE** to erase all characters.
 - Press **TONE X** to change the next letter to upper or lower case.
- Press **SAVE** to confirm. The screen shows **Saved to allow list**.

Delete an allow entry:

Using a cordless handset or the telephone base:

- Search for the desired entry in the allow list (see **Review allow list** on page 124).
- When the desired entry displays, press **MUTE/DELETE** on the handset or **X/DELETE** on the telephone base. The screen shows **Delete entry?**
- Press **YES** to confirm. The screen show **Entry deleted**, and the next entry displays. You cannot retrieve a deleted entry.



Note: If the allow list is empty after an entry is deleted, the screen displays **Allow list is empty**.

Delete all allow entries:

Using a cordless handset or the telephone base:

- Press **MENU** in idle mode to enter the main menu.
- Press **▼CID** or **▲DIR** on the handset, or press **▼CALLER ID** or **▲DIRECTORY** on the telephone base to scroll to **Smart call blk**, then press **SELECT**.
- Press **▼CID** or **▲DIR** on the handset, or press **▼CALLER ID** or **▲DIRECTORY** on the telephone base to scroll to **Allow list**, then press **SELECT**.
- Press **▼CID** or **▲DIR** on the handset, or press **▼CALLER ID** or **▲DIRECTORY** on the telephone base to scroll to **Delete all**, then press **SELECT**. The screen shows **Delete all in allow list?**
- Press **YES** to confirm. The screen displays **Deleted**. There is a confirmation tone.

Call block settings

Star name list

There are many organizations like schools, medical offices, and pharmacies that use robocalls to communicate important information to you. Robocall uses an autodialer to deliver pre-recorded messages. By entering the name of the organizations into the star name list, it ensures these calls will ring through when you only know the caller names but not their numbers.

If the first 15 characters of the incoming caller ID's name match a name saved in your star name list, the call will get through and ring. The star name list stores up to 10 names.

Add a star name entry:

Using a cordless handset:

1. Press **MENU** on the handset in idle mode to enter the main menu.
2. Press **▼CID** or **▲DIR** to scroll to **Smart call blk**, then press **SELECT**.
3. Press **▼CID** or **▲DIR** to scroll to **Star name list**, then press **SELECT**.
4. Press **▼CID** or **▲DIR** to scroll to **Add new entry**, then press **SELECT**.
5. When the screen displays **Enter name**, use the dialing keys to enter a name (up to 15 characters). Press a key repeatedly until the desired character appears. The first character of every word is capitalized.
 - ▶ Press **▼CID** or **▲DIR** to move the cursor to the left or right.
 - ▶ Press **0** to add a space.
 - ▶ Press **MUTE/DELETE** to erase a character.
 - ▶ Press and hold **MUTE/DELETE** to erase all characters.
 - ▶ Press **TONE ✕** to change the next letter to upper or lower case.
6. Press **SAVE** to store your star name entry.



Using the telephone base:

1. Press **MENU** on the telephone base in idle mode to enter the main menu.
2. Press **▼CALLER ID** or **▲DIRECTORY** to scroll to **Smart call blk**, then press **SELECT**.
3. Press **▼CALLER ID** or **▲DIRECTORY** to scroll to **Star name list**, then press **SELECT**.
4. Press **▼CALLER ID** or **▲DIRECTORY** to scroll to **Add new entry**, then press **SELECT**.

Call block settings

- When the screen displays **ENTER NAME**, use the dialing keys to enter a name (up to 15 characters). Press a key repeatedly until the desired character appears. The first character of every word is capitalized.
 - Press **▼CALLER ID** or **▲DIRECTORY** to move the cursor to the left or right.
 - Press **0** to add a space.
 - Press **X/DELETE** to erase a character.
 - Press and hold **X/DELETE** to erase all characters.
 - Press **TONE X** to change the next letter to upper or lower case.
- Press **SAVE** to store your star name entry.

Review star name list:

Using a cordless handset or the telephone base:

- Press **MENU** in idle mode to enter the main menu.
- Press **▼CID** or **▲DIR** on the handset, or press **▼CALLER ID** or **▲DIRECTORY** on the telephone base to scroll to **Smart call blk**, then press **SELECT**.
- Press **▼CID** or **▲DIR** on the handset, or press **▼CALLER ID** or **▲DIRECTORY** on the telephone base to scroll to **Star name list**, then press **SELECT** twice.
- Press **▼CID** or **▲DIR** on the handset, or press **▼CALLER ID** or **▲DIRECTORY** on the telephone base to browse through the star name entries.



Note: **Star name list is empty** appears if there are no star name entries.

Call block settings

Save a caller ID log entry to star name list:

Using a cordless handset or the telephone base:

1. Select a desired entry in the caller ID log (see **Review the caller ID log** on page 99).
2. When the desired entry appears, press **SAVE**.
3. Press **▼CID** or **▲DIR** on the handset, or press **▼CALLER ID** or **▲DIRECTORY** on the telephone base to highlight **Star name list**, and then press **SELECT**. The screen displays **Star this name?** and then the caller's name.
4. Press **SELECT** to confirm. The screen shows **Saved to star name list**.

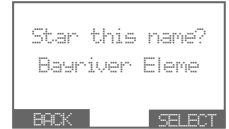

Edit a star name entry:

Using a cordless handset:

1. Search for the desired entry in the block list (see **Review star name list** on page 129).
2. When the desired entry displays, press **EDIT**. The screen displays **Edit name** along with the name to be edited.
3. To edit the name:
 - Use the dialing keys to enter characters.
 - Press **▼CID** or **▲DIR** to move the cursor to the left or right.
 - Press **0** to add a space.
 - Press **MUTE/DELETE** to erase a character.
 - Press and hold **MUTE/DELETE** to erase all characters.
 - Press **TONE ✕** to change the next letter to upper or lower case.
4. Press **SAVE** to confirm. The screen shows **Saved to star name list**.



Using the telephone base:

1. Search for the desired entry in the block list (see **Review star name list** on page 129).
2. When the desired entry displays, press **EDIT**. The screen displays **EDIT NAME** along with the name to be edited.



Call block settings

3. To edit the name:

- Use the dialing keys to enter characters.
- Press **▼CALLER ID** or **▲DIRECTORY** to move the cursor to the left or right.
- Press **0** to add a space.
- Press **X/DELETE** to erase a character.
- Press and hold **X/DELETE** to erase all characters.
- Press **-tone X** to change the next letter to upper or lower case.



4. Press **SAVE** to confirm. The screen shows **Saved to star name list**.

Delete a star name entry:

Using a cordless handset or the telephone base:

1. Search for the desired entry in the star name list (see **Review star name list** on page 129).
2. When the desired entry displays, press **MUTE/DELETE** on the handset or **X/DELETE** on the telephone base. The screen shows **Delete entry?**.
3. Press **YES** to confirm. The screen show **Entry deleted**, and the next entry displays. You cannot retrieve a deleted entry.

Delete all star name entries:

Using a cordless handset or the telephone base:

1. Press **MENU** in idle mode to enter the main menu.
2. Press **▼CID** or **▲DIR** on the handset, or press **▼CALLER ID** or **▲DIRECTORY** on the telephone base to scroll to **Smart call blk**, then press **SELECT**.
3. Press **▼CID** or **▲DIR** on the handset, or press **▼CALLER ID** or **▲DIRECTORY** on the telephone base to scroll to **Star name list**, then press **SELECT**.
4. Press **▼CID** or **▲DIR** on the handset, or press **▼CALLER ID** or **▲DIRECTORY** on the telephone base to scroll to **Delete all**, then press **SELECT**. The screen shows **Delete all in star name list?**.
5. Press **YES** to confirm. The screen displays **Deleted**. There is a confirmation tone.

Call block settings

Screening announcements

If you have set to screen home calls without numbers and/or screen uncategorized home calls, the callers of one or all of the following incoming call categories will hear a screening announcement.

- Home calls that are “out of area” or with numbers set to “Private”.
- Home calls with numbers that are not in your directory, allow list, or block list, or with absent caller ID number.
- Home calls with caller ID names that are not in your star name list.

The telephone has two screening options, and each option has its default screening announcements.

Screening with caller name - *“Hello. Calls to this number are being screened by Smart call blocker. Please say your name after the tone, then press pound.”*

-OR-

Screening without caller name - *“Hello. Calls to this number are being screened by Smart call blocker. If you’re a family member, friend or invited caller, please press pound to be connected. If you’re a solicitor, please hang up now.”*

You can use these announcements, or record your own name to replace “*this number*” in both announcements.

Play your current announcement of screening with caller name:

Using a cordless handset or the telephone base:

1. Press **MENU** in idle mode to enter the main menu.
2. Press **▼CID** or **▲DIR** on the handset, or press **▼CALLER ID** or **▲DIRECTORY** on the telephone base to scroll to **Smart call blk**, then press **SELECT**.
3. Press **▼CID** or **▲DIR** on the handset, or press **▼CALLER ID** or **▲DIRECTORY** on the telephone base to scroll to **Screening annc**, then press **SELECT**.
4. Press **▼CID** or **▲DIR** on the handset, or press **▼CALLER ID** or **▲DIRECTORY** on the telephone base to scroll to **Play annc**, then press **SELECT**.
5. Press **▼CID** or **▲DIR** on the handset, or press **▼CALLER ID** or **▲DIRECTORY** on the telephone base to scroll to **w/ Caller name**, then press **SELECT**.



Call block settings

Play your current announcement of screening without caller name:

Using a cordless handset or the telephone base:

1. Press **MENU** in idle mode to enter the main menu.
2. Press **▼CID** or **▲DIR** on the handset, or press **▼CALLER ID** or **▲DIRECTORY** on the telephone base to scroll to **Smart call blk**, then press **SELECT**.
3. Press **▼CID** or **▲DIR** on the handset, or press **▼CALLER ID** or **▲DIRECTORY** on the telephone base to scroll to **Screening annc**, then press **SELECT**.
4. Press **▼CID** or **▲DIR** on the handset, or press **▼CALLER ID** or **▲DIRECTORY** on the telephone base to scroll to **Play annc**, then press **SELECT**.
5. Press **▼CID** or **▲DIR** on the handset, or press **▼CALLER ID** or **▲DIRECTORY** on the telephone base to scroll to **w/o Caller name**, then press **SELECT**.



Record your name for all screening announcements:

Using a cordless handset or the telephone base:

1. Press **MENU** in idle mode to enter the main menu.
2. Press **▼CID** or **▲DIR** on the handset, or press **▼CALLER ID** or **▲DIRECTORY** on the telephone base to scroll to **Smart call blk**, then press **SELECT**.
3. Press **▼CID** or **▲DIR** on the handset, or press **▼CALLER ID** or **▲DIRECTORY** on the telephone base to scroll to **Screening annc**, then press **SELECT**.
4. Press **▼CID** or **▲DIR** on the handset, or press **▼CALLER ID** or **▲DIRECTORY** on the telephone base to scroll to **Rec your name**, then press **SELECT**. The system announces, "Record after the tone. Press stop when you are done."
5. Speak towards the handset to record your name, if you are using the handset, or speak towards the telephone base to record your name, if you are using the telephone base. Press **STOP** to end recording.

To listen to the announcement with your recorded name again, scroll to **Play annc** and press **SELECT**.

Call block settings

Reset all your screening announcements:

Using a cordless handset or the telephone base:

1. Press **MENU** in idle mode to enter the main menu.
2. Press **▼CID** or **▲DIR** on the handset, or press **▼CALLER ID** or **▲DIRECTORY** on the telephone base to scroll to **Smart call blk**, then press **SELECT**.
3. Press **▼CID** or **▲DIR** on the handset, or press **▼CALLER ID** or **▲DIRECTORY** on the telephone base to scroll to **Screening annc**, then press **SELECT**.
4. Press **▼CID** or **▲DIR** on the handset, or press **▼CALLER ID** or **▲DIRECTORY** on the telephone base to scroll to **Reset annc**, then press **SELECT**. The screen shows **Reset to default annc?**. Press **YES** to confirm. The screen shows **Annnc. reset to default** before returning to the previous menu.



-OR-

While an announcement is playing, press **MUTE/DELETE** on the handset, or press **X/DELETE** on the telephone base. The screen shows **Annnc. Deleted** before returning to the previous menu.

Your name will be deleted from all the screening announcements, and the telephone will use the default screening announcements described on page 132.

Call block settings

Voice guide to set Smart call blocker

This feature is an easy and alternative way for you to do the basic setup of Smart call blocker. You can follow the voice guide to set your telephone system to allow or to screen all incoming home calls, or to screen home calls that do not display a phone number.

This feature is only available in the telephone base.

1. When the telephone base is in idle mode, press **MENU** to enter the main menu.
2. Press **▼CALLER ID** or **▲DIRECTORY** to scroll to **Smart call blk**.
3. Press **▼CALLER ID** or **▲DIRECTORY** to scroll to **Voice guide**, then press **SELECT**. You hear a voice prompt, *“Hello! This voice guide will assist you with the basic setup of Smart call blocker...”*
4. Set up your Smart call blocker feature by inputting designated numbers, as instructed in the voice guide.
 - ▶ Press **1** if you want to screen home calls with telephone numbers that are not saved in your directory, allow list or star name list;
 - ▶ Press **2** if you only want to screen home calls that do not display a phone number; or
 - ▶ Press **3** if you do not want to screen calls, and want to allow all incoming calls to get through.



Notes:

- ▶ The screening feature of Smart call blocker is applicable to home calls only. All incoming cell calls will get through and ring. If you want to block a cell call, add the number to the block list. See **Block list** on page 116.
- ▶ You can press **CANCEL** on the telephone base to quit the voice guide at any time.
- ▶ After a power outage, the system prompts you to set the date and time. After the date and time setting is done or skipped, the system then prompts if you want to set up Smart call blocker via voice guide. Press **YES** to start the setup.

Allowed calls

If Smart call blocker is on, the following types of incoming calls can get through to you and ring on your telephone system:

- ▶ Home calls with numbers saved in your allow list.
- ▶ Home calls with numbers saved in your directory, but not in your block list.
- ▶ Home calls with caller ID names saved in your star name list.
- ▶ Cell calls with numbers not saved in your block list.



Note: When Smart call blocker is off, all incoming calls will ring on your telephone system, including calls with numbers saved in the block list.

Allow home calls without numbers

If Smart call blocker is on, and you have set to allow calls without numbers, the following type of incoming calls will ring on your telephone system.

- ▶ Home calls that are “out of area” or with numbers set to “Private”.



Allowed calls

Allow uncategorized home calls

If Smart call blocker is on, and you have set to allow uncategorized calls, the following type of incoming calls will ring on your telephone system.

- Home calls with numbers that are not in your directory, allow list or block list, or with absent caller ID number.
- Home calls with caller ID names that are not in your star name list.



Note: If you have set to allow all uncategorized calls, the caller's number will not be saved to the allow list. If you want to save the caller's number to your allow list or block list, you can retrieve the number from caller ID log and save it to the allow list or block list. See **Save a caller ID log entry to the block list** on page 118 and **Save a caller ID log entry to the star name list** on page 130.



Blocked calls

If Smart call blocker is on, incoming home or cell calls with numbers saved in your block list will not ring. The telephone plays the block announcement “*Calls to this number are being screened by Smart call blocker. The number you are calling is not accepting your call. Please hang up.*” to the caller, and the call will be terminated.



Note: If Smart call blocker is off, incoming calls with numbers saved in your block list will ring on your telephone system.



Block home calls without numbers

If Smart call blocker is on, and you have set to block calls without numbers, the following type of incoming calls will not ring, and the calls will be terminated.

- Home calls that are “out of area” or with numbers set to “Private”.

The telephone plays the block announcement “*Calls to this number are being screened by Smart call blocker. The number you are calling is not accepting your call. Please hang up.*” to the caller.



Note: The telephone can respond to remote access code while it is playing the block announcement. This allows you to access your answering system from an unknown number remotely. See **Remote access** on page 168.



Smart call blocker

Blocked calls

Block uncategorized home calls

If Smart call blocker is on, and you have set to block uncategorized calls, the following type of incoming calls will not ring, and the calls will be terminated.

- ▶ Home calls with numbers which are not in your directory, allow list or block list, or with absent caller ID number.
- ▶ Home calls with caller ID names that are not in your star name list.

The telephone plays the block announcement “*Calls to this number are being screened by Smart call blocker. The number you are calling is not accepting your call. Please hang up.*” to the caller.



Notes:

- ▶ If you have set to block all uncategorized calls, the caller’s numbers will not be saved to the block list. If you want to save the caller’s number to your allow list or block list, you can retrieve the number from caller ID log and save it to the allow list or block list. See **Save a caller ID log entry to the block list** on page 118 and **Save a caller ID log entry to the allow list** on page 124.
- ▶ The telephone can respond to remote access code while it is playing the block announcement. This allows you to access your answering system from an unknown number remotely. See **Remote access** on page 168.



Screen home calls without numbers

If Smart call blocker is on, and your telephone is set to screen calls without number, the telephone will not ring when receiving incoming home calls that are “out of area” or with numbers set to “Private”. It plays a screening announcement to the caller and asks the caller to respond before putting the call through to you.

The telephone has two screening options. You can set your Smart call blocker to screen these calls by asking the callers to record their names and then press the pound key (#). Alternatively, you can screen these calls by only asking the callers to press the pound key (#).

Screen home calls without numbers and ask for caller names

When screening a call, the telephone announces to the caller, *“Hello. Calls to this number are being screened by Smart call blocker. Please say your name after the tone, then press pound.”* After the caller completes the request, the telephone announces to the caller *“Please wait a moment while your call is connected.”*. The telephone starts ringing and announces the caller’s name. The telephone screen displays **Screened call** and you can pick up the call. The telephone will then ask whether you want to answer or reject the call, or to forward the call to the answering system.

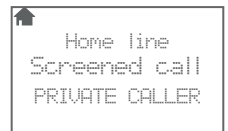

Screen home calls without numbers and do not ask for caller names

When screening a call, the telephone announces to the caller, *“Hello. Calls to this number are being screened by Smart call blocker. If you’re a family member, friend or invited caller, please press pound to be connected. If you’re a solicitor, please hang up now.”* After the caller presses the pound key (#), the telephone announces to the caller *“Please wait a moment while your call is connected.”*. The telephone starts ringing, and you can answer the call. This option is suitable for you to filter calls that uses autodialers to deliver pre-recorded messages, for example, robocalls and telemarketing calls.



Notes:

- ▶ The telephone announces to the caller with *“Hello. Calls to this number are being screened by Smart call blocker...”* If you have recorded your name in the screening announcements, your recorded name will replace *“this number”* in the announcements. See **Screening announcements** on page 132.
- ▶ If the caller hangs up before the call is screened, or without leaving his/her name while the call is being screened, the call will be logged as missed call in the caller ID log.

Screen home calls without numbers

- ▶ While a call is being screened, you can press **ANSWER**, **HOME/FLASH** or **SPEAKER** to stop screening and answer the call.
- ▶ After the telephone screened a call, and is ringing and announcing the caller's name, you can press **OFF/CANCEL** or **SILENCE** to silence the ringer, or press **BLOCK** to reject the call directly.
- ▶ After you picked up a screened call and the telephone is announcing the screening options, you can press **OFF/CANCEL** to hang up the call.
- ▶ If you receive a call waiting call without number while on a call, Smart call blocker will not screen the new call. You can press **HOME/FLASH**, **CELL 1**, **CELL 2** or **SPEAKER** to take the new call.
- ▶ Robocalls are unable to respond to the screening announcement, and therefore, will not get through and ring. If you want to allow some robocalls to get through, save their names in the star name list. See page 128.
- ▶ The telephone can respond to remote access code while it is playing the screening announcement. This allows you to access your answering system from an unknown number remotely. See **Remote access** on page 168.

Answer call once

1. When the telephone starts ringing, and the screen displays **Screened call**:
 - ▶ On the handset, press **HOME/FLASH** or **SPEAKER** to pick up the call.

-OR-

- ▶ On the telephone base, press **HOME** to pick up the call.

If you have turned on the caller ID announce feature, the telephone announces “*You have a call from...*” and the caller’s name. After you picked up the call, the telephone announces “*To answer the call, press 1. To send this call to the answering system, press 4. To repeat these options, press **”.

2. Press **1** to answer the call. The telephone number will not be added to your allow list.



Notes:

- ▶ To turn on or off caller ID announce, see page 43.
- ▶ When the telephone is ringing, you can press **SILENCE** to mute the ringer temporarily.

Screen home calls without numbers

Send call to answering system

1. When the telephone starts ringing, and the screen displays **Screened call:**
 - On the handset, press **HOME/FLASH** or **SPEAKER** to pick up the call.

-OR-

 - On the telephone base, press **HOME** to pick up the call.

If you have turned on the caller ID announce feature, the telephone announces “*You have a call from...*” and the caller’s name. After you picked up the call, the telephone announces “*To answer the call, press 1. To send this call to the answering system, press 4. To repeat these options, press **”.
2. Press **4** to send the caller to the answering system.



Notes:

- To turn on or off caller ID announce, see page 43.
- When the telephone is ringing, you can press **SILENCE** to mute the ringer temporarily.
- The caller is sent to the answering system and can leave a message even if the answering system is off.

End call

1. When the telephone starts ringing, and the screen displays **Screened call:**
 - On the handset, press **HOME/FLASH** or **SPEAKER** to pick up the call.

-OR-

 - On the telephone base, press **HOME** to pick up the call.

If you have turned on the caller ID announce feature, the telephone announces “*You have a call from...*” and the caller’s name. After you picked up the call, the telephone announces “*To answer the call, press 1. To send this call to the answering system, press 4. To repeat these options, press **”.
2. If you do not want to take the call, press **OFF/CANCEL** to end the call.

Screen uncategorized home calls

If Smart call blocker is on, and your telephone is set to screen uncategorized calls, the telephone will not ring when receiving the following incoming calls:

- ▶ Incoming home calls with absent caller ID numbers;
- ▶ Incoming home calls with numbers that are not in your directory, allow list, nor block list; or
- ▶ Incoming home calls with names that are not in your star name list.

The telephone plays a screening announcement to the caller and asks the caller to respond before putting the call through to you. There are two screening options. You can set your Smart call blocker to screen these calls by asking the callers to record their names and then press the pound key (#). Alternatively, you can screen these calls by only asking the callers to press the pound key (#).

Screen uncategorized home calls and ask for caller names

When screening a call, the telephone announces to the caller, *“Hello. Calls to this number are being screened by Smart call blocker. Please say your name after the tone, then press pound.”* After the caller completes the request, the telephone announces to the caller *“Please wait a moment while your call is connected.”* The telephone starts ringing and announces the caller’s name. The telephone screen displays **Screened call** and you can pick up the call. The telephone will then ask whether you want to answer or reject the call, or to forward the call to the answering system.

Screen uncategorized home calls without asking for caller names

When screening a call, the telephone announces to the caller, *“Hello. Calls to this number are being screened by Smart call blocker. If you’re a family member, friend or invited caller, please press pound to be connected. If you’re a solicitor, please hang up now.”* After the caller presses the pound key (#), the telephone announces to the caller *“Please wait a moment while your call is connected.”* The telephone starts ringing, and you can pick up the call. This option is suitable for you to filter calls that uses autodialers to deliver pre-recorded messages, for example, robocalls and telemarketing calls.

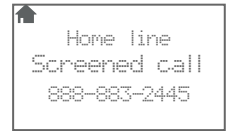

Screen uncategorized home calls



Notes:

- ▶ You can set Smart call blocker to screen and filter all uncategorized home calls from numbers or names that are not saved in your directory, allow list, block list, or star name list. You can easily add incoming phone numbers to your allow list and block list. This allows you to build up your lists of allowed and blocked numbers, and Smart call blocker will know how to deal with these calls when they come in again.
- ▶ The telephone announces to the caller with *"Hello. Calls to this number are being screened by Smart call blocker..."* If you have recorded your name in the screening announcements, your recorded name will replace *"this number"* in the announcements. See **Screening announcements** on page 132.
- ▶ If the caller hangs up before the call is screened, or without leaving his/her name while the call is being screened, the call will be logged as missed call in the caller ID log.
- ▶ While a call is being screened, you can press **ANSWER**, **HOME/FLASH** or **SPEAKER** to stop screening and answer the call.
- ▶ After the telephone screened a call, and is ringing and announcing the caller's name, you can press **OFF/CANCEL** or **SILENCE** to silence the ringer, or press **BLOCK** to reject the call directly. The caller's number will be added to the block list.
- ▶ After you picked up a screened call and the telephone is announcing the screening options, you can press **OFF/CANCEL** to hang up the call. The caller's number will not be saved to the block list.
- ▶ If the Smart call blocker feature is on and in screening mode, and you receive a call waiting home call:
 - If you have already picked up a screened home call, the telephone checks whether the call waiting call's number can be found in the directory, block list or allow list. It also checks whether the caller name is in the star name list. After that, the telephone displays the caller ID information or **Blocked call** accordingly. You can press **HOME/FLASH** or **SPEAKER** to take the new call.
 - If the telephone is screening a home call, the call waiting call will be ignored and logged as missed call in the caller ID log.
- ▶ If the Smart call blocker feature is on and in screening mode, and you receive a call waiting cell call:
 - If you have already picked up a screened home call, the telephone checks whether the call waiting cell call's number can be found in the block list. If yes, the telephone displays **Blocked call** and rejects the call.
- ▶ The screening feature of Smart call blocker is applicable to home calls only.
- ▶ Robocalls are unable to respond to the screening announcement, and therefore, will not get through and ring. If you want to allow some robocalls to get through, save their names in the star name list. See page 128.
- ▶ The telephone can respond to remote access code while it is playing the screening announcement. This allows you to access your answering system from an unknown number remotely. See **Remote access** on page 168.

Screen uncategorized home calls

Allow call once

1. When the telephone starts ringing, and the screen displays **Screened call**:
 - ▶ On the handset, press **HOME/FLASH** or **SPEAKER** to pick up the call.

-OR-

- ▶ On the telephone base, press **HOME** to pick up the call.

If you have turned on the caller ID announce feature, the telephone announces “*You have a call from...*” and the caller’s name. After you picked up the call, the telephone announces “*To answer the call, press 1. To answer and always allow this number, press 2. To block this number, press 3. To send this call to the answering system, press 4. To repeat these options, press **”.

2. Press **1** to answer the call. The telephone number will not be added to your allow list.



Notes:

- ▶ To turn on or off caller ID announce, see page 43.
- ▶ When the telephone is ringing, you can press **SILENCE** to mute the ringer temporarily.

Always allow

1. When the telephone starts ringing, and the screen displays **Screened call**:
 - ▶ On the handset, press **HOME/FLASH** or **SPEAKER** to pick up the call.

-OR-

- ▶ On the telephone base, press **HOME** to pick up the call.

If you have turned on the caller ID announce feature, the telephone announces “*You have a call from...*” and the caller’s name. After you picked up the call, the telephone announces “*To answer the call, press 1. To answer and always allow this number, press 2. To block this number, press 3. To send this call to the answering system, press 4. To repeat these options, press **”.

2. Press **2** to answer the call. The telephone number will be added to your allow list.

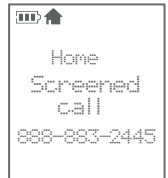

Notes:

- ▶ To turn on or off caller ID announce, see page 43.
- ▶ When the telephone is ringing, you can press **SILENCE** to mute the ringer temporarily.

Screen uncategorized home calls

Block call

1. When the telephone starts ringing, and the screen displays **Screened call**:
 - ▶ On the handset, press **HOME/FLASH** or **/SPEAKER** to pick up the call.

-OR-

- ▶ On the telephone base, press **HOME** to pick up the call.

If you have turned on the caller ID announce feature, the telephone announces “*You have a call from...*” and the caller’s name. After you picked up the call, the telephone announces “*To answer the call, press 1. To answer and always allow this number, press 2. To block this number, press 3. To send this call to the answering system, press 4. To repeat these options, press *.*”

2. Press **3** or **BLOCK** to block the call. The telephone plays the block announcement “*The number you are calling is not accepting your call. Please hang up.*” to the caller. The telephone number will be added to your block list.

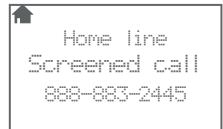
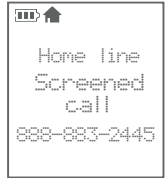

Notes:

- ▶ To turn on or off caller ID announce, see page 43.
- ▶ When the telephone is ringing, you can press **SILENCE** to mute the ringer temporarily.

Send call to answering system

1. When the telephone starts ringing, and the screen displays **Screened call**:
 - ▶ On the handset, press **HOME/FLASH** or **/SPEAKER** to pick up the call.
- OR-**
- ▶ On the telephone base, press **HOME** to pick up the call.

If you have turned on the caller ID announce feature, the telephone announces “*You have a call from...*” and the caller’s name. After you picked up the call, the telephone announces “*To answer the call, press 1. To answer and always allow this number, press 2. To block this number, press 3. To send this call to the answering system, press 4. To repeat these options, press *.*”

2. Press **4** to forward the call to the answering system.



Note: The call is forwarded to the answering system and the caller can leave a message even if the answering system is off.

Option while on a call

When you are on a home or cell call and speaking to the caller, and you do not want to continue the call, you can press **BLOCK** to end the call. The telephone plays the block announcement “*The number you are calling is not accepting your call. Please hang up.*” to the caller, and the call will be terminated. The caller’s number, if available, will be added to your block list.

Using a cordless handset or the telephone base:

- Press **BLOCK**. The screen displays **Block and end?** and the caller’s number, if available. Press **YES** to end the call.



Notes:

- The caller’s number, if available, will be saved to the block list. The screen displays **Added to block list** after pressing **YES**. If caller’s number is not available, the screen displays **No number available to block.**
- You can press **BLOCK** to end the call even if Smart call blocker is turned off.

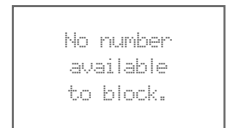
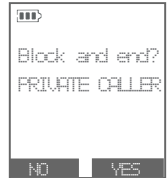

Answering system settings

Use the answering system menu of a system handset or the telephone base to set up the announcement message, turn on or off the answering system or message alert tone, activate call screening, or change the number of rings, remote access code or message recording time.

Announcement

Your outgoing announcement plays when calls are answered by the answering system.

The telephone has a default outgoing announcement, *“Hello. Please leave a message after the tone.”* You can use this announcement, or record your own.

You can record an announcement up to 90 seconds. The system does not record any announcement shorter than two seconds.

To play your current outgoing announcement:

Using a cordless handset:

1. When the handset is in idle mode, press **MENU** to enter the main menu.
2. Press **▼CID** or **▲DIR** to scroll to **Answering sys**, then press **SELECT**.
3. Press **SELECT** again to select **Announcement**.
4. Press **▼CID** or **▲DIR** to scroll to **Play annc**, then press **SELECT**.



Using the telephone base:

1. When the telephone base is in idle mode, press **MENU** to enter the main menu.
2. Press **SELECT** to select **Answering sys**.
3. Press **SELECT** again to select **Announcement**.
4. Press **▼CALLER ID** or **▲DIRECTORY** to scroll to **Play annc**, then press **SELECT**.



Answering system settings

To record a new outgoing announcement:

Using a cordless handset:

1. When the handset is in idle mode, press **MENU** to enter the main menu.
2. Press **▼CID** or **▲DIR** to scroll to **Answering sys**, then press **SELECT**.
3. Press **SELECT** again to select **Announcement**.
4. Press **SELECT** to select **Record annnc**. The system announces, *"Record after the tone. Press STOP when you are done."*
5. Speak towards the handset to record your announcement. Press **STOP** to end recording. Your recorded announcement plays.



To listen to the recorded announcement again, scroll to **Play annnc** and press **SELECT**.

Using the telephone base:

1. When the telephone base is in idle mode, press **MENU** to enter the main menu.
2. Press **SELECT** to select **Answering sys**.
3. Press **SELECT** again to select **Announcement**.
4. Press **SELECT** to select **Record annnc**. The system announces, *"Record after the tone. Press STOP when you are done."*
5. Speak towards the telephone base to record your announcement. Press **STOP** to end recording. Your recorded announcement plays.



To listen to the recorded announcement again, scroll to **Play annnc** and press **SELECT**.

Answering system settings

To delete or reset your outgoing announcement:

Using a cordless handset:

1. When the handset is in idle mode, press **MENU** to enter the main menu.
2. Press **▼CID** or **▲DIR** to scroll to **Answering sys**, then press **SELECT**.
3. Press **SELECT** again to select **Announcement**.
4. Press **▼CID** or **▲DIR** to scroll to **Play annc**, then press **SELECT**.
5. While the announcement is playing, press **MUTE/DELETE** to delete the announcement. The system announces “*Announcement deleted*”.

-OR-

1. When the handset is in idle mode, press **MENU** to enter the main menu.
2. Press **▼CID** or **▲DIR** to scroll to **Answering sys**, then press **SELECT**.
3. Press **SELECT** again to select **Announcement**.
4. Press **▼CID** or **▲DIR** to scroll to **Reset annc**, then press **SELECT**. The screen shows **Reset to default annc?**.
5. Press **YES** to confirm. The screen shows **Annc. reset to default**.



Answering system settings

Using the telephone base:

1. When the telephone base is in idle mode, press **MENU** to enter the main menu.
2. Press **SELECT** to select **Answering sys.**
3. Press **SELECT** again to select **Announcement.**
4. Press **▼CALLER ID** or **▲DIRECTORY** to scroll to **Play annc.**, then press **SELECT.**
5. While the announcement is playing, press **X/DELETE** to delete the announcement. The system announces "Announcement deleted".

-OR-

1. When the telephone base is in idle mode, press **MENU** to enter the main menu.
2. Press **SELECT** to select **Answering sys.**
3. Press **SELECT** again to select **Announcement.**
4. Press **▼CALLER ID** or **▲DIRECTORY** to scroll to **Reset annc.**, then press **SELECT.** The screen shows **Reset to default annc?.**
5. Press **YES** to confirm. The screen shows **Ann. reset to default.**

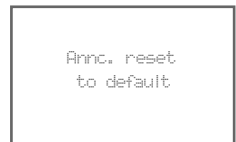

When your announcement is deleted, the system answers calls with the default announcement described on page 148. You cannot delete the default announcement.

Answering system settings

Answer on/off

Unless you change it, the answering system is on and ready to record messages. You can turn the answering system off, but if you do so, the answering system does not answer calls and record incoming messages.

To turn the answering system on or off:

Using a cordless handset:

1. When the handset is in idle mode, press **MENU** to enter the main menu.
2. Press **▼CID** or **▲DIR** to scroll to **Answering sys**, then press **SELECT**.
3. Press **▼CID** or **▲DIR** to scroll to **Answer On/Off**, then press **SELECT**.
4. Press **▼CID** or **▲DIR** to highlight **On** or **Off**, then press **SELECT** to save the setting. You hear a confirmation tone.

When the answering system is on, the handset shows **ANS ON**.



Answering system settings

Using the telephone base:

Press **ANSWER ON** to turn the answering system on or off. If the answering system is turned on, it announces, "Calls will be answered." If the answering system is turned off, it announces, "Calls will not be answered."

-OR-

1. When the telephone base is in idle mode, press **MENU** to enter the main menu.
2. Press **SELECT** to select **Answering sys.**
3. Press **▼CALLER ID** or **▲DIRECTORY** to scroll to **Answer ON/OFF**, then press **SELECT**.
4. Press **▼CALLER ID** or **▲DIRECTORY** to highlight **On** or **Off**, then press **SELECT** to save the setting. You hear a confirmation tone.



Note: If the answering system is off and there is an incoming call, the system answers after ten rings and announces, "Please enter your remote access code." For more information about remote access, see page 168.

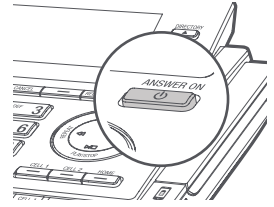

Answering system settings

Voice guide to set Answering system

This feature is an alternative way for you to do the basic setup of the answering system. You can follow the voice guide to record your own announcement, set the number of rings, and set the message alert tone.

Using a cordless handset:

1. When the handset is in idle mode, press **MENU** to enter the main menu.
2. Press **▼CID** or **▲DIR** to scroll to **Answering sys**, then press **SELECT**.
3. Press **▼CID** or **▲DIR** to scroll to **Voice guide**, then press **SELECT**. You hear a voice prompt, "This voice guide will assist you with the basic setup of your answering system."
4. Set up your answering system by inputting designated numbers, as instructed in the voice guide.

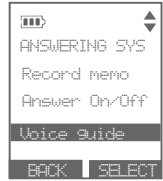

Using the telephone base:

1. When the telephone base is in idle mode, press **MENU** to enter the main menu.
2. Press **SELECT** to select **Answering sys**.
3. Press **▼CALLER ID** or **▲DIRECTORY** to scroll to **Voice guide**, then press **SELECT**. You hear a voice prompt, "This voice guide will assist you with the basic setup of your answering system."
4. Set up your answering system by inputting designated numbers, as instructed in the voice guide.

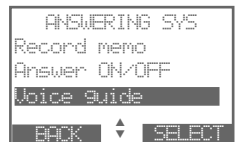

Notes:

- ▶ You can press **OFF/CANCEL** on the handset or press **CANCEL** on the telephone base to quit the voice guide at any time.
- ▶ If the system does not receive any input, it will play an alert message. If there is still no input, it will announce "Sorry, I still have not received any input. If you want to restart the voice guide, please enter the menu and select Voice guide under Answering system. Good bye."
- ▶ After a power outage, the system prompts you to set the date and time, and Smart call blocker. After that, the system prompts if you want to set up the answering system via voice guide. Press **YES** to start the setup.

Answering system settings

Call screening

Use this feature to choose whether incoming messages can be heard over the speaker when they are being recorded. If you turn call screening on, you hear the incoming message. While monitoring an incoming message, you can answer the call by pressing **HOME/FLASH** on the handset, or **HOME** on the telephone base.

To change the setting:

Using a cordless handset:

1. When the handset is in idle mode, press **MENU** to enter the main menu.
2. Press **▼CID** or **▲DIR** to scroll to **Answering sys**, then press **SELECT**.
3. Press **▼CID** or **▲DIR** to scroll to **Ans sys setup**, then press **SELECT**.
4. Press **SELECT** to select **Call screening**.
5. Press **▼CID** or **▲DIR** to choose **On** or **Off**.
6. Press **SELECT** to save the setting. You hear a confirmation tone.

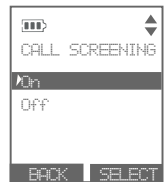

Using the telephone base:

1. When the telephone base is in idle mode, press **MENU** to enter the main menu.
2. Press **SELECT** to select **Answering sys**.
3. Press **▼CALLER ID** or **▲DIRECTORY** to scroll to **Ans sys setup**, then press **SELECT**.
4. Press **SELECT** to select **Call screening**.
5. Press **▼CALLER ID** or **▲DIRECTORY** to choose **On** or **Off**.
6. Press **SELECT** to save the setting. You hear a confirmation tone.



Note: For more information on call screening, see page 155.

Answering system settings

Number of rings

You can set the answering system to answer an incoming call after two, three, four, five or six rings. You can also select toll saver. If toll saver is selected, the answering system answers a call after two rings when you have new messages, and after four rings when there are no new messages. This feature allows you to check for new messages and avoid paying long distance charges when calling from out of your local area. By default, the answering system answers an incoming call after four rings.

To set the number of rings:

Using a cordless handset:

1. When the handset is in idle mode, press **MENU** to enter the main menu.
2. Press **▼CID** or **▲DIR** to scroll to **Answering sys**, then press **SELECT**.
3. Press **▼CID** or **▲DIR** to scroll to **Ans sys setup**, then press **SELECT**.
4. Press **▼CID** or **▲DIR** to scroll to **# of rings**, then press **SELECT**.
5. Press **▼CID** or **▲DIR** to choose among **2, 3, 4, 5, 6** or **Toll saver**.
6. Press **SELECT** to save the setting. You hear a confirmation tone.

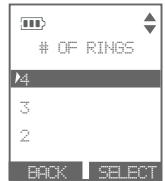

Using the telephone base:

1. When the telephone base is in idle mode, press **MENU** to enter the main menu.
2. Press **SELECT** to select **Answering sys**.
3. Press **▼CALLER ID** or **▲DIRECTORY** to scroll to **Ans sys setup**, then press **SELECT**.
4. Press **▼CALLER ID** or **▲DIRECTORY** to scroll to **# of rings**, then press **SELECT**.
5. Press **▼CALLER ID** or **▲DIRECTORY** to choose among **2, 3, 4, 5, 6** or **Toll saver**.
6. Press **SELECT** to save the setting. You hear a confirmation tone.



Notes:

- ▶ If you set the number of rings for the answering system as 2 or 3 rings, the caller ID announce feature may not have enough time to announce the caller's full information.
- ▶ If Smart call blocker is on, the first ring of all incoming calls will be muted.

Answering system settings

Remote access code

To access your answering system remotely from any touch-tone phone, you need to enter a two-digit number (00-99). By default, the remote access code is **19**.

To change the remote access code:

Using a cordless handset:

1. When the handset is in idle mode, press **MENU** to enter the main menu.
2. Press **▼CID** or **▲DIR** to scroll to **Answering sys**, then press **SELECT**.
3. Press **▼CID** or **▲DIR** to scroll to **Ans sys setup**, then press **SELECT**.
4. Press **▼CID** or **▲DIR** to scroll to **Remote code**, then press **SELECT**.
5. Use the dialing keys to enter a two-digit number. Press **MUTE/DELETE** to backspace and delete a digit.
6. Press **SAVE** to save the setting. You hear a confirmation tone.



Using the telephone base:

1. When the telephone base is in idle mode, press **MENU** to enter the main menu.
2. Press **SELECT** to select **Answering sys**.
3. Press **▼CALLER ID** or **▲DIRECTORY** to scroll to **Ans sys setup**, then press **SELECT**.
4. Press **▼CALLER ID** or **▲DIRECTORY** to scroll to **Remote code**, then press **SELECT**.
5. Use the dialing keys to enter a two-digit number. Press **X/DELETE** to backspace and delete a digit.
6. Press **SAVE** to save the setting. You hear a confirmation tone.



Answering system settings

Message alert tone

When the message alert tone is set to **On**, and there is at least one new message, the telephone base beeps every ten seconds. Unless you change it, the message alert tone is set to off.

There is no audible alert at the handset.

To change the setting:

Using a cordless handset:

1. When the handset is in idle mode, press **MENU** to enter the main menu.
2. Press **▼CID** or **▲DIR** to scroll to **Answering sys**, then press **SELECT**.
3. Press **▼CID** or **▲DIR** to scroll to **Ans sys setup**, then press **SELECT**.
4. Press **▼CID** or **▲DIR** to scroll to **Msg alert tone**, then press **SELECT**.
5. Press **▼CID** or **▲DIR** to choose **On** or **Off**.
6. Press **SELECT** to save the setting. You hear a confirmation tone.



Using the telephone base:

1. When the telephone base is in idle mode, press **MENU** to enter the main menu.
2. Press **SELECT** to select **Answering sys**.
3. Press **▼CALLER ID** or **▲DIRECTORY** to scroll to **Ans sys setup**, then press **SELECT**.
4. Press **▼CALLER ID** or **▲DIRECTORY** to scroll to **Msg alert tone**, then press **SELECT**.
5. Press **▼CALLER ID** or **▲DIRECTORY** to choose **On** or **Off**.
6. Press **SELECT** to save the setting. You hear a confirmation tone.



Notes:

- ▶ The message alert tone beeps only if all the following conditions are met:
 - Answering system is on.
 - Message alert tone setting is on.
 - There are new messages.
- ▶ To temporarily turn off the message alert tone, see page 163.

Answering system settings

Recording time

You can set the recording time allowed for incoming messages. The message length is three minutes by default.

To change the setting:

Using a cordless handset:

1. When the handset is in idle mode, press **MENU** to enter the main menu.
2. Press **▼CID** or **▲DIR** to scroll to **Answering sys**, then press **SELECT**.
3. Press **▼CID** or **▲DIR** to scroll to **Ans sys setup**, then press **SELECT**.
4. Press **▼CID** or **▲DIR** to scroll to **Recording time**, then press **SELECT**.
5. Press **▼CID** or **▲DIR** to choose **3 minutes**, **2 minutes** or **1 minute**, then press **SELECT** to save the setting. You hear a confirmation tone.



Using the telephone base:

1. When the telephone base is in idle mode, press **MENU** to enter the main menu.
2. Press **SELECT** to select **Answering sys**.
3. Press **▼CALLER ID** or **▲DIRECTORY** to scroll to **Ans sys setup**, then press **SELECT**.
4. Press **▼CALLER ID** or **▲DIRECTORY** to scroll to **Recording time**, then press **SELECT**.
5. Press **▼CALLER ID** or **▲DIRECTORY** to choose **3 minutes**, **2 minutes** or **1 minute**, then press **SELECT** to save the setting. You hear a confirmation tone.

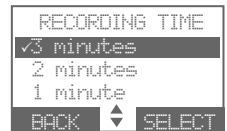
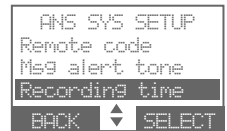

About the answering system

Answering system and voicemail indicators

Your telephone has separate indicators for two different types of voice messages: those left on its built-in digital answering system and those left at your telephone service provider's voicemail (fees may apply). Your telephone's built-in digital answering system messages and voicemail messages are separate. Each alerts you to new messages differently.

- If **OO** and **XX New msgs** show on the handset and **XX New messages** shown on the telephone base, there are new messages in the built-in answering system. To listen to messages recorded on your digital answering system, press **▶/■/PLAY/STOP** on the telephone base (page 164).
- If **✉** and **New voicemail** display on the handset and the telephone base, your telephone service provider is indicating that it has new voicemail for you. To listen to your voicemail, dial an access number provided by your telephone service provider, followed by a security code or PIN.

Some telephone service providers bundle or combine multiple services like voicemail and call waiting, so you may not be aware that you have voicemail. To check what services you have and how to access them, contact your telephone service provider.

To use your voicemail service rather than the answering system, turn off the answering system. To use the answering system rather than your voicemail service, contact your telephone service provider to deactivate the voicemail service.

About the answering system

Use the answering machine and voicemail together

You can also use your telephone answering system and voicemail together by setting your built-in answering system to answer before voicemail answers, as described below. To learn how to program your voicemail settings, contact your telephone service provider. If you are on a call, or the answering system is busy recording a message and you receive another call, the second caller can leave a voicemail message.

Set the answering system to answer calls at least two rings earlier than your voicemail is set to answer. For example, if your voicemail answers after six rings, set the answering system to answer after four rings. Some voicemail providers may program the delay before answering calls in seconds instead of rings. In this case, allow six seconds per ring when determining the appropriate setting.

Message capacity

The answering system can record up to 99 messages, depending on the length of each message. Individual messages can be up to three minutes (see **Recording time** on page 159), and the maximum recording time is approximately 22 minutes. The actual recording time depends on individual message characteristics. Messages remain available for replay until you delete them.

When there are new messages (including memos) on the answering system, the number of messages stored shows in the message counter.

If the answering system has less than three minutes of recording time left, it announces, *“Less than three minutes to record,”* before message playback at the handset or the telephone base. **Rec mem low** displays on the device screen in idle mode. When you turn on the answering system at the telephone base, it announces, *“Calls will be answered. Less than three minutes to record.”*

If the memory is full, the answering system announces, *“Memory is full,”* before message playback. The device screen displays **Rec mem full** in idle mode. Once the memory is full, you cannot turn the answering system back on if it has been turned off, nor can you record new messages until old ones have been deleted. **Memory full** displays if you want to turn on the answering system on the handset but there is no memory.

About the answering system

Voice prompts

The system provides voice prompts to guide you through the setup procedures at the telephone base, message playback, remote access and recording outgoing announcements.

Call screening

To screen a call at the telephone base:

If the answering system and call screening are on (see **Call screening** on page 155), the announcement and the incoming message broadcast at the telephone base when a call is answered by the answering system.

Options while a message is being recorded:

- Press **▼/VOLUME/▲** on the telephone base to adjust the call screening volume.
- Press **▶/■/PLAY/STOP** or **SILENCE** to temporarily silence the call screening.
- Press **▶/■/PLAY/STOP** or **SCREEN** to temporarily turn on the call screening if call screening is set to off.
- Press **HOME** to answer the call.

To screen a call at the handset:

If the answering system is on and your answering system is recording a message, press **SCREEN** to screen the call on your handset and the screen displays the caller ID information. If you do not subscribe to caller ID service, the handset shows **Incoming call**.

Options while a message is being recorded:

- Press **▼CID/VOLUME** or **▲DIR/VOLUME** on the handset to adjust the call screening volume.
- Press **🔇/OFF/CANCEL** or **SILENCE** to temporarily silence the call screening.
- Press **SCREEN** to temporarily turn on the call screening if call screening is set to off.
- Press **🔊/SPEAKER** to turn off the speakerphone and screen the call through the handset earpiece.

About the answering system

Call intercept

While screening a call, you can stop recording and speak to the caller by pressing **HOME/FLASH** on the handset, or pressing **HOME** on the telephone base.

Temporarily turn off the message alert tone

If the message alert tone is turned on, the telephone base beeps every ten seconds when there are new messages. Pressing any telephone base key (except **✎/HANDSET LOCATOR**) temporarily silences the message alert tone.

If you press **X/DELETE** when in idle mode to temporarily turn off the message alert tone, there is a voice prompt directing you to press **X/DELETE** again to delete all old messages. The message alert tone is temporarily off. Only press **X/DELETE** a second time if you wish to erase all old messages in your answering system.

The message alert tone resumes when you receive another message.

Message playback

If you have both new and old messages, you can play either new or old messages. The caller ID information displays on the screens when you play messages and you can call back the caller.

When playback begins, the handset screen and telephone base screen display the message status, caller ID information, and time and date of the message recorded. You hear the total number of messages followed by the day and time of the message. After the last message, the telephone announces, “*End of messages.*” and the screen displays **End of messages**.

To listen to messages at the telephone base:

Press **▶/■/PLAY/STOP** on the telephone base to listen to the messages.

- ▶ If there are new and old messages, press **▼CALLER ID** or **▲DIRECTORY** to select **Play new msgs** or **Play old msgs**, then press **SELECT** or **▶/■/PLAY/STOP**.
- ▶ If there are only new or only old messages, they will play automatically.

When the handset is playing a message, its screen shows **[2]-Call info** and the caller's name or number. If the caller's information is unavailable, the handset shows **No caller info**.

The system announces the number of messages, then begins playback. The message sequence is shown on the telephone base. If there are no recorded messages, the telephone base shows **No messages** and you hear, “*You have no message.*”

To listen to messages on a cordless handset:

1. When the handset is in idle mode, press **MENU** to enter the main menu.
2. Press **SELECT** to select **Play messages**.
 - ▶ If there are new and old messages, press **▼CID** or **▲DIR** to select **Play new msgs** or **Play old msgs**, then press **SELECT**.
 - ▶ If there are only new or only old messages, they will play automatically.

The system announces the number of messages, then begins playback. The message sequence is shown on the handset. If there are no recorded messages, the handset shows **No messages** and you hear, “*You have no message.*”

Message playback

Options during playback

When a message is playing, you can adjust the playback volume, skip, repeat, pause or delete the message.

When messages are playing on the telephone base:

- ▶ Press **▼/VOLUME/▲** to adjust the message playback volume.
- ▶ Press **▶▶/SKIP** or **SKIP** to skip to the next message.
- ▶ Press **◀◀/REPEAT** or **REPEAT** to repeat the message.
- ▶ Press **◀◀/REPEAT** or **REPEAT** twice to hear the previous message.
- ▶ Press **X/DELETE** to delete the message.
- ▶ Press **2** to pause the playback and show the caller ID information.
 - Press **HOME** or **CALL** to use the home line, or press **CELL 1** or **CELL 2** to use the cell line to call back the caller. If necessary, press **#** (pound key) or **1** to show different dialing options.
 - Press **CANCEL** or **BACK** to restart the playback. If you do not call back within 10 seconds, message playback restarts.
- ▶ Press **▶▶/PLAY/STOP** or **CANCEL** to stop the playback.

When messages are playing on the handset:

- ▶ Press **▼CID/VOLUME** or **▲DIR/VOLUME** to adjust the message playback volume.
- ▶ Press **SKIP** to skip to the next message.
- ▶ Press **REPEAT** to repeat the message. Press **REPEAT** twice to listen to the previous message.
- ▶ Press **MUTE/DELETE** to delete the message.
- ▶ Press **2** to pause the playback and show the caller ID information.
 - Press **HOME/FLASH, CALL** or **▶▶/SPEAKER** to use the home line, or press **CELL 1** or **CELL 2** to use the cell line to call back the caller. If necessary, press **#** (pound key) or **1** to show different dialing options.
 - Press **OFF/CANCEL** or **BACK** to restart the playback. If you do not call back within 10 seconds, message playback restarts.
- ▶ Press **OFF/CANCEL** to stop the playback.

Message playback

Delete all old messages

You can only delete old (reviewed) messages. You cannot delete new messages until you review them. You cannot retrieve deleted messages.

To delete all old messages on the telephone base:

1. When the telephone is idle, press **X/DELETE**. The system announces, *“To delete all old messages, press DELETE again.”*
2. Press **X/DELETE** again. The system announces, *“All old messages deleted!”*

-OR-

1. Press **MENU** when in idle mode to enter the main menu.
2. Press **SELECT** to select **Answering sys.**
3. Press **▼CALLER ID** or **▲DIRECTORY** to highlight **Delete all old**, then press **SELECT**. The screen shows **Delete all old messages?**
4. Press **YES** to confirm. The screen displays **Deleting...** and then **All old msgs deleted!**. There is a confirmation tone.

To delete all old messages on the handset:

1. Press **MENU** when in idle mode to enter the main menu.
2. Press **▼CID** or **▲DIR** to scroll to **Answering sys.** Press **SELECT**.
3. Press **▼CID** or **▲DIR** to highlight **Delete all old**, then press **SELECT**. The screen shows **Delete all old messages?**
4. Press **YES** to confirm. The screen displays **Deleting...** and then **All old msgs deleted!**. There is a confirmation tone.

Record and play memos

Memos are your own recorded messages used as reminders for yourself or others using the same answering system. You can record your own memos using a system handset or the telephone base. Play and delete them in the same way as incoming messages.

Record a memo

Using a cordless handset:

1. When the handset is in idle mode, press **MENU** to enter the main menu.
2. Press **▼CID** or **▲DIR** to scroll to **Answering sys**, then press **SELECT**.
3. Press **▼CID** or **▲DIR** to highlight **Record memo**, then press **SELECT**. The system announces, *"Record after the tone. Press STOP when you are done."*
4. Speak towards the handset to record a memo.
5. Press **STOP** to stop recording. The system announces, *"Recorded."* and then returns to the previous menu.



Using the telephone base:

1. When the telephone base is in idle mode, press **MENU** to enter the main menu.
2. Press **SELECT** to select **Answering sys**.
3. Press **▼CALLER ID** or **▲DIRECTORY** to highlight **Record memo**, then press **SELECT**. The system announces, *"Record after the tone. Press STOP when you are done."*
4. Speak towards the handset to record a memo.
5. Press **STOP** to stop recording. The system announces, *"Recorded."* and then returns to the previous menu.



Notes:

- ▶ The system announces *"Memory is full,"* if you attempt to record a memo when the memory is full.
- ▶ Each memo can be up to four minutes in length.
- ▶ Memos shorter than two seconds are not recorded.

Remote access

You can reach your answering system remotely by dialing your home telephone number from any touch-tone telephone.

To remotely reach your answering system:

1. Dial your telephone number from any touch-tone telephone.
2. Once the system answers, enter the two-digit remote access code (**19** is the default code. See page 157 to change it).
 - The system automatically announces the number of new or old messages (if any), and then begins to play them.
3. You can also enter the following remote commands:

Remote commands

1	Press to listen to all messages.
2	Press to listen to new messages only.
3	Press to delete the current message (during playback).
33	Press twice to delete all old messages.
4	Press to repeat the current message (during playback).
5	Press to stop any operation (including recording).
*5	Press to listen to a list of remote commands.
6	Press to skip to the next message (during playback).
*7	Press to record a new announcement.
8	Press to end remote access (the call will be terminated).
0	Press to turn the answering system on or off.

4. Hang up or press **8** to end the calls.

Remote access

Cut out and carry the remote access wallet card at the back of this user's manual for quick reference.



Notes:

- ▶ If you do not press any keys after you enter the remote access code, all new messages play. If there are no new messages, all old messages play.
- ▶ Once the new messages have played, the telephone announces the help menu options. If you do not press any key within 20 seconds, the remote access call automatically disconnects.
- ▶ When the answering system is turned off, the telephone answers after 10 rings, and announces, *"Please enter your remote access code."*
- ▶ When the memory is full, the answering system answers incoming calls after 10 rings and announces, *"Memory is full. Enter the remote access code."*
- ▶ The telephone can respond to remote access code while it is playing the screening announcement or block announcement. This allows you to access you answering system from an unknown number remotely. See **Screen home calls without numbers** on page 140 and **Screen uncategorized home calls** on page 143.

Add and register handsets/headsets/speakerphones

Your telephone can support up to 12 DECT 6.0 cordless handsets (AT&T model CLP99007, sold separately) or up to 10 cordless handsets and 2 cordless headsets and speakerphones (sold separately). Visit

www.telephones.att.com/accessories for a list of compatible DECT 6.0 cordless headsets and speakerphones. Each new handset, headset or speakerphone must be registered to the telephone base before use. You must register each handset, headset or speakerphone separately.

To register a cordless headset or speakerphone to this telephone system, please refer to the corresponding user's manual for more details. To register a cordless handset, see the following.

The handsets provided within your product box are already registered as **HANDSET 1**, and so forth. Additional handsets are assigned numbers in the sequential order they are registered (up to **HANDSET 12**).

Register a handset to the telephone base

Method 1:

1. Before you begin registration, make sure the handset is out of the telephone base or charger and shows **To register HS, see manual.**
2. Put the handset you wish to register on the telephone base cradle.

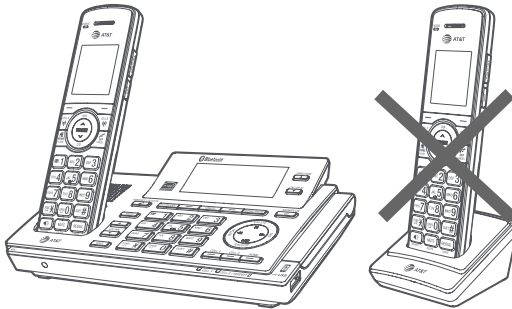

For registration, put the handset on the telephone base, not the handset charger.

3. The handset shows **Registering... Please wait**. If the registration is successful, both the handset and the telephone base screens display **HANDSET X Registered** (**HANDSET** represents the handset name, **X** represents the handset number). Both the handset and the telephone base beep. The handset is now registered with the telephone base.

Add and register handsets/headsets/speakerphones

If registration fails, the system will automatically try to register again. If registration fails after the third try, **Registration failed** appears on both screens. The handset shows **To register HS, see manual.** and the telephone base returns to idle mode. This may take up to five minutes to occur. Please start again from Step 1.

Method 2:

1. Press and hold /**HANDESET LOCATOR** on the telephone base for about four seconds and it shows **Registering... Please wait.**
2. Press **QUIET #** on the handset. The handset shows **Registering... Please wait.** If the registration is successful, both the handset and the telephone base screens display **HANDESET X Registered (HANDESET** represents the handset name, **X** represents the handset number). Both the handset and the telephone base beep. The handset is now registered with the telephone base.

If registration fails, **Registration failed** appears on both screens. The handset shows **To register HS, see manual.** and the telephone base returns to idle mode. This may take up to five minutes to occur. Please start again from Step 1.



Notes:

- ▶ You cannot register a handset if any other system handset is in use.
- ▶ If you try to register more than 12 handsets to the telephone base, the telephone base shows **Registration slots are full** and sounds two beeps.

Deregister handsets

You may need to deregister your handsets if:

- ▶ You have 12 registered handsets and need to replace a handset.

-OR-

- ▶ You wish to change the designated handset number of your registered handsets.

You must first deregister ALL handsets, and then register each handset you wish to use again, one at a time.

Please read carefully through all the instructions on this page before beginning the deregistration process.

Deregister all handsets from the telephone base

In addition to the cordless handsets, this operation will also deregister all cordless headsets and speakerphones registered to your telephone base.

1. Make sure that all handsets are out of the telephone base and chargers before you begin deregistration.
2. Press and hold /**HANDSET LOCATOR** on the telephone base for about ten seconds. The telephone base screen shows **Registering... Please wait** for five seconds, then it shows **Deregister all devices?**. Release /**HANDSET LOCATOR**.

Deregister
all devices?

NO YES
3. Immediately press /**HANDSET LOCATOR** again or press **YES**. You must press /**HANDSET LOCATOR** or **YES** within five seconds. If the telephone base returns to idle screen, start again with Step 1.
4. The telephone base shows **Deregistered all devices** when the registration completes. It takes up to ten seconds to complete the deregistration process. Before registering the handset again, wait for the cordless handset screen to display **To register HS, see manual**.
5. To register the handset(s) to the telephone base again, follow the registration instructions on pages 170-171.















Notes:

- ▶ If the deregistration process fails, you may need to reset the system and try again. To reset, unplug the power from the telephone base and plug it back in.
- ▶ You cannot deregister the handsets if any other system handset is in use.
- ▶ Even if the battery is depleted, you can still deregister the handsets by following the steps mentioned above. After the handset is charged for at least ten minutes, the screen shows **To register HS, see manual**.
- ▶ If you already have 12 registered handsets, the telephone base shows **Registration slots are full** and sounds two beeps in Step 2, as mentioned above. Continue holding /**HANDSET LOCATOR** until **Deregister all devices?** displays.













Alert tones and lights

Handset screen icons

	HOME line - On steadily when the home line is in use or there is an incoming home call.
	Search - you can perform 3-character alphabetical search to find entries quickly.
	CELL line - On steadily when a cell line is in use or there is an incoming cell call.
	Bluetooth connected devices - There are Bluetooth connected devices on the active devices list.
	Bluetooth disconnected devices - There are Bluetooth disconnected devices on the active devices list.
	Wireless Bluetooth headset - On steadily when a wireless Bluetooth headset is in use on the home line.
	Battery status - battery is charging (animated display).
	Battery status - the battery icon flashes when the battery is low and needs charging.
	Speakerphone - the speakerphone is in use.
	Ringer off - the handset ringer is off.
	New voicemail - you have new voicemail from your telephone service provider.
ANS ON	Answering system on - the answering system is turned on to answer calls.
	Message - new message in the built-in answering system.
ECO	ECO mode - activates automatically to reduce power consumption when the handset is within range from the telephone base.
NEW	New caller ID log - new and missed calls.
MUTE	MUTE - the handset microphone is off.

Alert tones and lights

Telephone base screen icons

	HOME line - On steadily when the home line is in use or there is an incoming home call.
	Search - you can perform 3-character alphabetical search to find entries quickly.
 1  2	CELL line- On steadily when a cell line is in use or there is an incoming cell call.
 1 2	Bluetooth connected devices - There are Bluetooth connected devices on the active devices list.
 1 2	Bluetooth disconnected devices - There are Bluetooth disconnected devices on the active devices list.
 2	Wireless Bluetooth headset - On steadily when a wireless Bluetooth headset is in use on the home line.
	Ringer off - the telephone base ringer is off.
	New voicemail - New voicemail received from your telephone service provider.
	Answering system on - The answering system is turned on.
	New answering system message - New message in the answering system.
	New caller ID log - Missed and new calls.
	Mute - Microphone is muted.

Alert tones and lights

Handset alert tones

One short beep	Tone of each key press, if key tone is turned on.
One long beep	Indication to begin recording a message, memo or announcement.
Two short beeps	You are pressing ▼CID or ▲DIR on a cordless handset when the volume is already at its highest or lowest setting. -OR- Call waiting tone. -OR- Error tone. -OR- Registration slots are full.
Confirmation tone (three rising tones)	The system has completed the command successfully.
Four beeps	The other party has ended your intercom call. -OR- The handset has gone out of range from the base during a call.
Four short beeps	Low battery warning.
Four rising tones	Your Android cell phone has received mobile notifications.

Alert tones and lights

Telephone base alert tones

One short beep	Tone of each key press, if key tone is turned on.
One long beep	Indication to begin recording a message, memo or announcement. Indicates the start of message recording during call screening or the end of a message playback session.
Two short beeps	You are pressing ▼/ VOLUME /▲ on the telephone base when the volume is already at its highest or lowest setting. -OR- Call waiting tone. -OR- Error tone. -OR- Registration slots are full.
Confirmation tone (three rising tones)	The system has completed the command successfully.
Four beeps	The other party has ended your intercom call.
Four short beeps	Registration failure tone.
Four rising tones	Your Android cell phone has received mobile notifications.
Beeps every ten seconds	Message alert.

Appendix

Alert tones and lights

Lights

▶/■/PLAY/STOP

- ▶ On when the answering system is playing recorded messages.
- ▶ Flashes when there are new messages.

📞/ANSWER ON

On when the answering system is on.

HOME

- ▶ On when the home line is in use.
- ▶ Flashes quickly when there is an incoming home call.
- ▶ Flashes slowly when the home call is on hold.

MUTE

On when the microphone is muted.

CELL 1/CELL 2/HEADSET lights

- ▶ On when the telephone base is paired and connected with a Bluetooth device.
- ▶ Flash alternately while pairing a Bluetooth device.
- ▶ Flash quickly when there is an incoming cell call.

CELL 1/CELL 2

- ▶ On when the cell line is in use.
- ▶ Flashes quickly when there is an incoming cell call.
- ▶ Flashes slowly when the cell call is on hold.

CHARGE light
On when the handset is charging in the telephone base or charger.

High contrast lighted display

Keypad

🔊/SPEAKER
On when the speakerphone is on.



Display screen messages

Screen messages

Added to allow list	The telephone has just added an entry to the allow list.
Added to block list	The telephone has just added an entry to the block list.
Added to star name list	The telephone has just added an entry to the star name list.
Activating remote voice control...	The telephone is activating remote voice control.
BASE 0 is calling	The telephone base is calling.
BASE 0 is calling all	The telephone base is calling all devices (for intercom calls).
Block list is empty	There are no call block entries.
Blocked call	An incoming call was blocked.
Blocking call...	The Smart call blocker feature of the telephone is rejecting a call with block announcement.
Bluetooth system busy	You are trying to make a cell call or access the Bluetooth menu when the Bluetooth link is already being used.
Call transferred	You have transferred an outside call to another device.
Caller ID log empty	There are no entries in the caller ID log.
Calling BASE 0	The handset is calling the telephone base (for intercom calls).
Calling HANDSET X	The handset or telephone base is calling another handset (for intercom calls). The telephone base is transferring an outside call to a handset.
Cell	The cell line is on a call.
Cell call on hold	A call on the cell line has been put on hold
Cell line in use	Another system handset is using the cell line.
Cell 1/2 alert: %%	The Android phone that you paired with this telephone received a mobile notification.

Display screen messages

Screen messages

Cell 1/2 low batt	Message received from Alerts manager that your cell phone's battery is low.
Connection failed	A Bluetooth device failed to establish a connection with your telephone system.
Connection timeout. Please check cell status.	The telephone has failed to activate remote voice control.
Contact deleted	A directory entry is deleted.
Directory empty	There are no directory entries.
Directory full	The directory is full. You cannot save any new entries unless you delete some current entries.
Downloading...	The system is downloading a directory from a cell phone.
Ended	You have just ended a call.
HANDSET X is calling	Another system handset is calling.
HANDSET X is calling all	The handset is calling all devices.
Home	The home line is on a call.
Home call on hold	A call on the home line has been put on hold.
Home & cell calls on hold	Calls on the home and cell lines have been put on hold.
Home & cell lines in use	Calls on the home and cell lines are being used.
Home line in use	A system handset or another telephone on the same home line is in use.
Incoming call	There is a call coming in.
Intercom	The device is on an intercom call.
Intercom ended	The intercom call has just ended.
Line in use	An extension phone, or one of the devices is in use.
Low battery	The battery is low. You should charge the battery.
Microphone ON	Mute is off so the other party can hear your voice.
Muted	The microphone is off. The other party cannot hear you.

Display screen messages

Screen messages

New voicemail	There are new voicemail messages from your telephone service provider.
No answer. Try again.	The device(s) you are trying to transfer a call to is out of range, off hook, or has no power.
No battery	The handset in the charger has no battery installed.
No Bluetooth device is ready for connection	There is no Bluetooth device paired to the telephone system when you press CELL 1/CELL 2 on the telephone base or press CELL 1 / CELL 2 on the handset.
No caller info	The caller information is unavailable.
No home line	There is no telephone line connection.
No entries found. Download from SIM only?	There are no entries found when you download a cell phone directory from the cell memory.
No entries found. Download from Phone only?	There are no entries found when you download a cell phone directory from your SIM card. There are no entries found in either the cell or SIM card when you download a cell phone directory from both memories.
No messages	There are no messages in the answering system.
No PTT call	The incoming PTT function is turned off. The handset will not receive PTT calls.
No signal. Call ended.	The phone lost connection with the telephone base or did not have a strong enough signal and the phone call ended.
Not available at this time	Someone else is already using the directory or caller ID log. When a handset tries to access the answering system or Bluetooth menu during battery backup mode.
Number already saved	The telephone number you have entered is already in the directory, allow list or block list..
Out of range OR no power at base	The telephone base has lost power, or the handset is out of range.
** Paging **	The cordless handset is paged by the telephone base.
Paging all devices	The telephone base is paging all devices.
Place in charger	The battery is very low. The handset should be charged.

Display screen messages

Screen messages

PTT From HANDSET X To devices: X	One handset has started a PTT session to another handset and telephone base.
PTT From HANDSET X To devices: X	One handset has started a PTT session to another handset.
PTT To HANDSET X	You have started the PTT process with a handset.
PTT To BASE 0	You have started the PTT process with the telephone base.
Push to talk Ended	The PTT session is ended.
Quiet mode on	QUIET mode is on.
Quiet mode is off	QUIET mode is turned off.
Rec mem full	The system recording time is full.
Rec mem low	The system recording time is low.
Registering... Please wait	The handset is registering to the telephone base.
Registration slots are full	The telephone base has the maximum of 12 handsets registered to it.
Registration failed	The handset registration is not successful.
Remote voice control ended.	The remote voice control operation is ended.
Ringer off	The ringer is turned off.
Ringer muted	The ringer is off temporarily while the device is ringing.
Saved to directory	An entry has been successfully saved in the directory.
Screened call	The Smart call blocker feature of the telephone has screened a call and is putting the call through to you.
Setting up Answering system...	The telephone is playing voice guide.
Smart call blk screening...	The Smart call blocker feature of the telephone is screening a call and playing the screening announcement to the caller.

Display screen messages

Screen messages

To register HS, see manual.	Screen display before handset registration.
Unable to call. Try again	You try to join a call when there are already four handsets on that call. You try to make an outside call when another device is transferring a call with the intercom feature.
Start voice guide to set up Smart call blocker now?	After you install your telephone or power returns following a power outage, the telephone will prompt you to set the date and time. After the date and time setting is done or skipped, the telephone will then prompt if you want to set up the Smart call blocker feature via voice guide.
XX Missed calls	There are new calls in the caller ID log.
XX New msgs	Displays on handset screen when you have new messages in the answering system.
XX New messages	Displays on telephone base screen when you have new messages in the answering system.

Troubleshooting

If you have difficulty with your phone, please try the following suggestions. For Customer Service, visit our website at **www.telephones.att.com** or call **1 (800) 222-3111**. In Canada, dial **1 (866) 288-4268**.

I cannot pair my cell phone to the telephone base.

- ▶ Make sure you have cellular coverage.
- ▶ Make sure your cell phone is compatible with your telephone system. Check the Bluetooth compatibility list at **www.telephones.att.com/bluetooth**.
- ▶ Make sure the Bluetooth function of your cell phone is turned on. See the user's manual of your cell phone for more information.
- ▶ Make sure that you set your cell phone to search for devices.
- ▶ If the telephone systems in your cell phone device history list, delete it and try pairing again.
- ▶ Carefully follow the pairing instructions on pages 22-23 and make sure that your cell phone is not connected to any other Bluetooth device.
- ▶ Turn off your cell phone, then turn it on again.
- ▶ Reset the telephone base. Unplug the unit's electrical power. Wait for approximately 15 seconds, then plug it back in. Repeat the suggestions mentioned above.

I cannot pair my headset to the telephone base.

- ▶ Make sure that your Bluetooth headset is in discoverable mode when pairing with the telephone base. See the user's manual of your headset for more information on how to set your headset to discoverable mode.
- ▶ Make sure your headset is compatible with your telephone system. Check the Bluetooth compatibility list at **www.telephones.att.com/bluetooth**.
- ▶ Carefully follow the pairing instructions on pages 24-25 and make sure that your headset is not connected to any other Bluetooth device.
- ▶ Reset the telephone base. Unplug the unit's electrical power. Wait for approximately 15 seconds, then plug it back in. Repeat the suggestions mentioned above.

Troubleshooting

I cannot connect my cell phone with the telephone base.

- Make sure that the Bluetooth function of your cell phone is turned on. See the user's manual of your cell phone for more information.
- Make sure that your Bluetooth cell phone is not connected to any other Bluetooth device.
- Turn off your cell phone, then turn it on again.
- Make sure that your cell phone is on the active devices list.
- For some cell phones, you must authorize the **CLP99287/CLP99387/CLP99447/CLP99457/CLP99487/CLP99547/CLP99557/CLP99587** device in your cell phone's Bluetooth feature. See the user's manual of your cell phone for more information.
- Manually connect your cell phone to your telephone system. Refer to the user's manual of your cell phone for more information.

I cannot connect my headset with the telephone base.

- Make sure that your Bluetooth headset is not connected to any other Bluetooth device.
- Make sure that your headset is on the active devices list.

I cannot put my headset in discoverable mode.

- Refer to the user's manual of your headset for information on how to set your headset to discoverable mode.
- Make sure that the headset is not connected to any other Bluetooth device in order to successfully pair and connect to the telephone base.
- Carefully follow the pairing process on pages 24-25.
- Reset the telephone base. Unplug the unit's electrical power. Wait for approximately 15 seconds, then plug it back in. Repeat the suggestions mentioned above.

I don't know how to search for or add new devices on my cell phone.

- Most cell phones have the Bluetooth feature in the connection or setup menus. Please refer to the user's manual of your cell phone.
- In general, press the menu key on your cell phone, then look for the Bluetooth menu in the settings or connection menu. In the Bluetooth menu, select the option to search for or add new devices.

Troubleshooting

My cell phone disconnects with the telephone base.

- › Turn off your cell phone, then turn it on again.
- › Make sure that you are not using your cell phone when on a cell call.

My cell phone is connected to the telephone base, but I cannot make a cell call.

- › Make sure that your cell phone is not in use when you are trying to make a cell call.
- › For some smartphones, make sure that the cellular function is turned on.

Bluetooth system busy appears on the display.

- › Make sure that your cell phone is not in use when connected and on the active devices list.
- › Make sure that your cell phone or headset is not connected to any other Bluetooth device.
- › Your telephone system can only use one Bluetooth device at a time.

The PIN on the telephone base does not work.

- › The default PIN is **0000**.
- › If you have changed the PIN, it will appear on the telephone base in the pairing process.

I cannot hear any audio on my telephone system when on a cell call.

- › Make sure that your cell phone's volume is not too low or muted.
- › Reset the telephone base. Unplug the unit's electrical power. Wait for approximately 15 seconds, then plug it back in.
- › Turn off your cell phone, then turn it on again.

The listening volume of my cell call is too loud or quiet.

- › During a cell call, if the listening volume is too loud or quiet, try changing the volume on your cell phone. On some cell phones, changing the volume on the cell phone effects your cell call volume on the **CLP99287/CLP99387/CLP99447/CLP99457/CLP99487/CLP99547/CLP99557/CLP99587**.

Troubleshooting

I cannot download contacts from my cell phone to my CLP99287/CLP99387/CLP99447/CLP99457/CLP99487/CLP99547/CLP99557/CLP99587.

- Make sure that your cell phone is paired and connected to the base.
- Make sure you place your cell phone next to the base while downloading.
- If your cell phone does not support the download, you can send the directory from your cell phone. The system can receive the directory automatically. See the user's manual of your cell phone for more information.

I see duplicate entries in my downloaded directory.

- If you see duplicate directory entries, you can delete them manually. Another option is to download again either your SIM card or phone memory, but not both.

Some of my cell phone contacts were not imported to my CLP99287/CLP99387/CLP99447/CLP99457/CLP99487/CLP99547/CLP99557/CLP99587.

- Try copying the contacts from your SIM card to your cell phone memory first, then download from your phone memory. If that doesn't work, try copying the contacts from your cell phone memory to your SIM card, then download from your SIM card. For more information on how to transfer contacts between your SIM card and your phone memory, refer to the user's manual of your cell phone.

Can the CLP99287/CLP99387/CLP99447/CLP99457/CLP99487/CLP99547/CLP99557/CLP99587 help the poor cell phone reception in my house?

- If your cell phone has poor reception in your home, the **CLP99287/CLP99387/CLP99447/CLP99457/CLP99487/CLP99547/CLP99557/CLP99587** cannot improve the reception. However, if you have a location in your house with better reception, you can leave your cell phone in that location while you use **CLP99287/CLP99387/CLP99447/CLP99457/CLP99487/CLP99547/CLP99557/CLP99587** cell line. In order for this to work, the cell phone must be within 30 feet of the telephone base for optimal performance.

The phone doesn't play my iPhone ringtone when there is an incoming call.

- Make sure your iPhone operating system is iOS 4.1 or later.
- Make sure you have turned on the **Cell ringer** feature (page 34).

Troubleshooting

The iPhone ringtone played is unclear or too loud with noise.

- ▶ The quality of ringtone played on your telephone is subject to individual ringtone characteristics.
- ▶ Try using another iPhone ringtone to test the quality.

My telephone doesn't work at all.

- ▶ Make sure the power cord is securely plugged in.
- ▶ Make sure you plug the battery connector securely into the cordless handset.
- ▶ Make sure you plug the telephone line cord securely and firmly into the telephone base and the telephone wall jack.
- ▶ Charge the battery in the cordless handset for at least ten hours. For optimum daily performance, return the cordless handset to the telephone base or charger when not in use.
- ▶ If the battery is depleted, it may take approximately 30 minutes to charge the handset before it shows **Low battery**. See page 12 for details.
- ▶ Reset the telephone base. Unplug the electrical power. Wait for approximately 15 seconds, then plug it back in. Allow up to one minute for the cordless handset and telephone base to reset.
- ▶ You may need to purchase a new battery. Please refer to **Battery installation and charging** in this user's manual on pages 12-14.

The remote voice control feature does not work.

- ▶ Make sure the operating system of your cell phone is iOS 8 or later, or Android 4 or later.
- ▶ Make sure your cell phone is paired and connected to your telephone system via Bluetooth.
- ▶ Make sure no Bluetooth applications are running in the background of your cell phone.
- ▶ Keep your cell phone within 15 feet of the telephone base.
- ▶ Do not lock up your cell phone's screen or set passcode for activating the voice-controlled application (voice app).
- ▶ Make sure you have turned on or logged in to the applications on your cell phone that you will be sending your voice commands, such as GPS, e-mail and social networking accounts.

Troubleshooting

- ▶ Make sure your cell phone's data or Wi-Fi signal is in full strength and your cell phone can connect to the Internet.
- ▶ Try to activate the voice app on your cell phone to ensure it is in place.
- ▶ Once you have activated the remote voice control feature, you are using your cell phone's voice app to operate your cell phone. If the voice commands do not work, please check the cell phone user's manual and the voice app's help topics to find out what commands you can use and any limitations of the voice app.
- ▶ Some cell phone manufacturers or network carriers may customize the phone's operating system and implement their own voice app. If you want to use Google Now, you need to manually set it as your default voice app. For detailed instructions, refer to your cell phone user's manual, or contact your cell phone's manufacturer or network carrier. You may also go to "Google Product Forums" on the Internet and check the corresponding help topics.
- ▶ Due to the settings of cell phones, some cell phones may not support the remote voice control feature. Contact your cell phone's manufacturer or network carrier if you encounter any problems.

The remote voice control feature ends unexpectedly while it is in use.

- ▶ The Bluetooth function of your cell phone may be off, or you may have moved your cell phone out of Bluetooth range of the telephone base. Make sure the Bluetooth function of your cell phone is turned on and keep your cell phone within 15 feet of the telephone base.
- ▶ The data or Wi-Fi connection of your cell phone may be lost. Make sure your cell phone's data or Wi-Fi signal is in full strength.
- ▶ The feature may be ended automatically by your cell phone. For example, a cell call has been established via the remote voice control feature and the call has just ended.
- ▶ If you receive a landline or cell line incoming call when you have activated remote voice control on a connected cell phone, the remote voice control operation will be ended.
- ▶ The voice-controlled application of your cell phone may be affected by other cell phone operations in the background. If the problem persists, contact your cell phone's network carrier.

Troubleshooting

I cannot press any dialing keys (0-9, TONE~~X~~, QUIET #) when I am on a cell call using the remote voice control feature.

- ▶ When you press the dialing keys on the handset or telephone base during a cell call using the remote voice control feature, the telephone system may have no response and the call may be ended. Please use the cell lines of your telephone system for calls that require using the dialing keys during the call (see **Make, answer or end a cell call** on page 55).

The display shows No home line. I cannot get a dial tone.

- ▶ Try all the suggestions mentioned above.
- ▶ If the previous suggestions do not work, disconnect the telephone line cord from your telephone and connect the telephone line cord to another telephone.
 - ▶ If there is no dial tone on that other telephone either, the telephone line cord may be defective. Install a new telephone line cord.
 - ▶ If changing the telephone line cord does not help, the wall jack (or the wiring to this wall jack) may be defective. Try using a different wall jack in your home to connect your **CLP99287/CLP99387/CLP99447/CLP99457/CLP99487/CLP99547/CLP99557/CLP99587** telephone, or contact your telephone service provider (charges may apply).

I cannot dial out.

- ▶ Try all the suggestions mentioned above.
- ▶ Make sure you have a dial tone before dialing. The cordless handset may take a second or two to find the telephone base and produce a dial tone. This is normal. Wait an extra second before dialing.
- ▶ Eliminate any background noise. Noise from a television, radio or other appliances may cause the phone to not dial out properly. If you cannot eliminate the background noise, first try muting the cordless handset before dialing, or dialing from another room with less background noise.
- ▶ If other phones in your home are having the same problem, contact your telephone service provider (charges may apply).

Troubleshooting

During power outage, I put a handset in the telephone base but the system fails to power up.

- ▶ Make sure the handset you placed in the telephone base has enough charge to power up the system.
- ▶ Try removing and re-installing the handset's battery. Place the handset in the telephone base again.

My cordless handset isn't performing normally.

- ▶ Make sure you plug the power cord securely into the telephone base. Plug the power adapter into a different working electrical outlet without a wall switch.
- ▶ Move the cordless handset closer to the telephone base. You may have moved out of range.
- ▶ Reset the telephone base. Unplug the electrical power. Wait for 15 seconds, then plug it back in. Allow up to one minute for the cordless handset and telephone base to reset.
- ▶ Other electronic products such as HAM radios and other DECT phones, can cause interference with your cordless phone. Try installing your phone as far away as possible from these types of electronic devices.

Out of range OR No pwr at base appears on my cordless handset.

- ▶ Ensure you plug the telephone base in properly and the power is on.
- ▶ Place the cordless handset in the telephone base for one minute to allow the cordless handset and base to synchronize.
- ▶ Move the cordless handset closer to the telephone base. You may have moved out of range.
- ▶ Reset the telephone base. Unplug the electrical power. Wait for 15 seconds, then plug it back in. Allow up to one minute for the cordless handset and telephone base to reset.
- ▶ Other electronic products such as HAM radios and other DECT phones, can cause interference with your cordless phone. Try installing your phone as far away as possible from these types of electronic devices.

Troubleshooting

The batteries do not hold a charge.

- ▶ If the cordless handset is in the telephone base or charger and the charge light is not on, refer to **The charge light is off** (page 193).
- ▶ Charge the battery in the cordless handset for at least ten hours. For optimum daily performance, return the cordless handset to the telephone base or charger when not in use.
- ▶ If the battery is depleted, it may take approximately 30 minutes to charge the handset before it shows **Low battery**. Refer to the table on page 12 for details.
- ▶ You may need to purchase a new battery. Please refer to **Battery installation and charging** in this user's manual on pages 12-14.

I get noise, static, or weak signals even when I'm near the telephone base.

- ▶ If you subscribe to high-speed Internet service (DSL - digital subscriber line) through your telephone line, you must install a DSL filter between the telephone line cord and the telephone wall jack (page 10). The filter prevents noise and caller ID problems as a result of DSL interference. Please contact your DSL service provider for more information about DSL filters.
- ▶ You may be able to improve the performance of your cordless phone by installing your new telephone base as far as possible from any other existing cordless telephone system that may already be installed.
- ▶ Other electronic products such as HAM radios and other DECT phones, can cause interference with your cordless phone. Try installing your phone as far away as possible from these types of electronic devices.
- ▶ Do not install this phone near a microwave oven or on the same electrical outlet. You may experience decreased performance while the microwave oven is operating.
- ▶ If you plug your phone in with a modem or a surge protector, plug the phone (or modem/surge protector) into a different location. If this does not solve the problem, relocate your phone or modem farther apart from one another, or use a different surge protector.
- ▶ Move your phone to a higher location. The phone may have better reception in a high area.
- ▶ If other phones in your home are having the same problem, contact your telephone service provider (charges may apply).

Troubleshooting

I experience poor sound quality when using the handset speakerphone.

- ▶ For increased sound quality while using the handset speakerphone, place the handset on a flat surface with the dial pad facing up.

I hear other calls while using my phone.

- ▶ Disconnect the telephone base from the telephone jack, and plug in a different telephone. If you still hear other calls, call your telephone service provider.

My cordless handset does not ring when I receive a call.

- ▶ If the Smart call blocker feature of your telephone is on and in default screening mode, the telephone will screen all incoming calls with numbers that are not saved in your directory, allow list, block list, or star name list. While screening, the telephone plays the screening announcement to the callers and asks the caller to respond before putting the call through to you. To turn on or off Smart call blocker, see page 112.
- ▶ Make sure that the ringer is not off. Refer to **Ringer volume** on page 39 in this user's manual.
- ▶ Make sure you plug in the telephone line cord securely into the telephone base and the telephone jack. Make sure you plug in the power cord securely.
- ▶ The cordless handset may be too far from the telephone base.
- ▶ Charge the battery in the cordless handset for at least ten hours. For optimum daily performance, return the cordless handset to the telephone base or charger when not in use.
- ▶ You may have too many extension phones on your telephone line to allow all of them to ring simultaneously. Try unplugging some of the other phones.
- ▶ The layout of your home or office may be limiting the operating range. Try moving the telephone base to another location, preferably to a higher location.
- ▶ If other phones in your home are having the same problem, contact your telephone service provider (charges may apply).
- ▶ Test a working phone at the phone jack. If another phone has the same problem, contact your telephone service provider (charges may apply).

Troubleshooting

- ▶ Other electronic products can cause interference with your cordless phone. Try installing your phone as far away as possible from electronic devices such as television sets, VCRs, or other cordless telephones.
- ▶ Remove the battery. Install the battery again and place the cordless handset into the telephone base. Wait for the cordless handset to reestablish its connection with the telephone base. Allow up to one minute for this to take place.
- ▶ Your line cord may be defective. Try installing a new line cord.

My calls cut in and out while I'm using my cordless handset.

- ▶ Other electronic products such as HAM radios and other DECT phones, can cause interference with your cordless phone. Try installing your phone as far away as possible from these types of electronic devices.
- ▶ Do not install this phone near a microwave oven or on the same electrical outlet. You may experience decreased performance while the microwave oven is operating.
- ▶ If you plug your phone in with a modem or surge protector, plug the phone (or modem/surge protector) into a different location. If this does not solve the problem, relocate your phone or modem farther apart from one another, or use a different surge protector.
- ▶ Move your telephone base to a higher location. The phone may have better reception when installed in a high area.
- ▶ If other phones in your home are having the same problem, contact your telephone service provider (charges may apply).

The charge light is off.

- ▶ Make sure you plug the power and line cords in correctly and securely.
- ▶ Unplug the electrical power. Wait for 15 seconds, then plug it back in. Allow up to one minute for the cordless handset and telephone base to reset.
- ▶ Clean the cordless handset, charger and telephone base charging contacts each month with a pencil eraser or cloth.
- ▶ A blinking **CHARGE** light is an indication that the battery is not connected to the handset or is missing completely. Ensure that the battery is installed properly.

Troubleshooting

My caller ID isn't working.

- Caller ID is a subscription service. You must subscribe to this service from your telephone service provider for this feature to work on your phone.
- The caller may not be calling from an area that supports caller ID.
- Both your and your caller's telephone service providers must use caller ID compatible equipment.
- If you subscribe to high-speed Internet service (DSL - digital subscriber line) through your telephone line, you must install a DSL filter between the telephone line cord and the telephone wall jack (page 10). The filter prevents noise and caller ID problems resulting from DSL interference. Please contact your DSL service provider for more information about DSL filters.

System does not receive caller ID when on a call.

- Make sure you subscribe to caller ID with call waiting features from your telephone service provider. Caller ID features works only if both you and the caller are in areas offering caller ID service, and if both telephone service providers use compatible equipment.

System screens all my incoming home calls.

- You may have set Smart call blocker to screen calls without numbers and uncategorized calls. The telephone asks callers to announce their names or press the pound key (#). We recommend that you add the phone numbers of your family members and friends, and desired businesses to your **Directory** (see page 86) or **Allow list** (see page 122), or add their names to the **Star name list** (see page 128). This will avoid Smart call blocker to screen their calls.
- To turn Smart call blocker off, see **Set Smart call blocker on/off** on page 112.

My telephone does not screen incoming cell calls.

- The screening feature of Smart call blocker is applicable to home calls only. All incoming cell calls will get through and ring. You can block calls of a cell phone number by adding the number to the block list. See **Block list** on page 116.

Troubleshooting

My telephone blocks calls from someone I know.

- ▶ You may have saved the caller's number in your block list. To remove the number from the block list, see **Delete a block entry** on page 121.

I want to block a cell phone number.

- ▶ If you want to block calls of a cell phone number, add the number to the block list. See **Block list** on page 116.

While screening a home call, the telephone suddenly stops screening and connects to the call.

- ▶ Another handset may have picked up the screening call.
- ▶ If you have other telephone system sharing the same telephone line, and someone picks up the call on the other telephone system while the screening is in progress, the screening process will be terminated and connect you to the caller.

Blocking home calls with numbers saved in my block list only.

- ▶ If you want to block calls with numbers saved in your block list only, and allow all other calls to get through to you, change the settings to accept calls without numbers and uncategorized calls. See **Control home calls without numbers** on page 112 and **Control uncategorized home calls** on page 114.

Blocking all unknown home calls.

- ▶ If you want to block all unknown home calls with numbers or names that are not in your directory, allow list or star name list, change the settings to block calls without numbers and uncategorized calls. See **Control home calls without numbers** on page 112 and **Control uncategorized home calls** on page 114.

Forwarding all unknown home calls to the answering system.

- ▶ If you want to forward all unknown home calls with numbers or names that are not in your directory, allow list or star name list to the answering system, see **Control home calls without numbers** on page 112 and **Control uncategorized home calls** on page 114 to change the settings.

Troubleshooting

Incomplete messages.

- ▶ If a caller leaves a very long message, part of it may be lost when the system disconnects the call after the maximum recording time you have set.
- ▶ If the caller pauses for longer than seven seconds, the system stops recording and disconnects the call.
- ▶ If the system's memory becomes full during a message, the system stops recording and disconnects the call.
- ▶ If the caller's voice is very soft, the system may stop recording and disconnect the call.

Difficulty hearing messages.

- ▶ Press **VOLUME/▲** to increase the telephone base speaker volume.
- ▶ Press **▲DIR/VOLUME** to adjust the message playback volume on a handset.

System does not answer after the correct number of rings.

- ▶ Make sure that the answering system is on. **ANS ON** should show on the handset and the **📞/ANSWER ON** light on the telephone base should be on.
- ▶ If toll saver is activated, the number of rings changes to two when you have new messages stored (page 156).
- ▶ If the memory is full or the system is off, the system will answer after ten rings.
- ▶ In some cases, the answering system is affected by the ringing system used by your telephone service provider.
- ▶ If you subscribe to voicemail service, change the number of rings so that your answering system answers before your voicemail (page 156). To determine how many rings activate your voicemail, contact your telephone service provider.
- ▶ If there is a fax machine connected to the same telephone line, try disconnecting the fax machine. If that solves the problem, consult your fax machine documentation for information on compatibility with answering systems.

System does not respond to remote commands.

- ▶ Make sure to enter your remote access code correctly (page 168).
- ▶ Make sure you are calling from a touch-tone phone. When you dial a number, you should hear tones. If you hear clicks, the phone is not a touch-tone telephone and cannot activate the answering system.

Troubleshooting

- ▶ The answering system may not detect the remote access code while your announcement is playing. Try waiting until the announcement is over before entering the code.
- ▶ There may be interference on the phone line you are using. Press dialing keys firmly.

System does not record messages.

- ▶ Make sure the answering system is on. **ANS ON** should show on the handset and the /ANSWER ON light on the telephone base should be on.
- ▶ Make sure the memory of the answering system is not full.
- ▶ If you subscribe to voicemail service, change the number of rings so that your answering system answers before your voicemail (page 156). To determine how many rings activate your voicemail, contact your telephone service provider.
- ▶ If there is a fax machine connected to the same telephone line, try disconnecting the fax machine. If that solves the problem, consult your fax machine documentation for information on compatibility with answering systems.

System announces, “Time and day not set.”

- ▶ You need to reset the system clock (page 41).

Outgoing announcement is not clear.

- ▶ When you record your announcement, make sure you speak in a normal tone of voice, about nine inches from the handset or the telephone base.
- ▶ Make sure there is no background noise (TV, music, etc.) while recording.

New voicemail and show on the screens, and I don’t know why.

- ▶ Your telephone has both a built-in answering system and voicemail indication. If **New voicemail** and  appear on the screens, then your telephone has received a signal from your telephone service provider that you have a voicemail message waiting for you to retrieve from them. Contact your telephone service provider for more information on how to access your voicemail.

Troubleshooting

I cannot retrieve voicemail messages.

- Your telephone has both a built-in answering system and voicemail indication. They are independent features and each alerts you to new messages differently (page 160). If you subscribe to voicemail service from your telephone service provider, contact your telephone service provider for more information on how to access your voicemail.

I've set my LCD language to Spanish or French and I don't know how to change it back to English.

- Press **MENU** on your handset or base in idle mode, then enter **364#** on the handset or base. You hear a confirmation tone.

I subscribe to a nontraditional telephone service that uses my computer to establish connections, and my telephone doesn't work.

- Make sure your computer is powered on.
- Make sure your Internet connection is working properly.
- Make sure that the software is installed and running for your nontraditional telephone service.
- If you are using a firewall, it may prevent access to your nontraditional telephone service provider. Contact your service provider for more information.

Common cure for electronic equipment.

If the telephone does not seem to be responding normally, try putting the cordless handset in the telephone base or charger. If it does not fix the problem, do the following (in the order listed):

1. Disconnect the power to the telephone base.
2. Disconnect the cordless handset battery.
3. Wait a few minutes.
4. Connect power to the telephone base.
5. Remove the battery. Replace the battery and place the cordless handset into the telephone base or charger.
6. Wait for the cordless handset to reestablish its connection with the telephone base. Allow up to one minute for this to take place.

Maintenance

Taking care of your telephone

- ▶ Your cordless telephone contains sophisticated electronic parts, so you must treat it with care.
- ▶ Avoid rough treatment.
- ▶ Place the handset down gently.
- ▶ Save the original packing materials to protect your telephone if you ever need to ship it.

Avoid water

- ▶ You can damage your telephone if it gets wet. Do not use the handset in the rain, or handle it with wet hands. Do not install the telephone base near a sink, bathtub or shower.

Electrical storms

- ▶ Electrical storms can sometimes cause power surges harmful to electronic equipment. For your own safety, take caution when using electric appliances during storms.

Cleaning your telephone

- ▶ Your telephone has a durable plastic casing that should retain its luster for many years. Clean it only with a soft cloth slightly dampened with water or mild soap.
- ▶ Do not use excess water or cleaning solvents of any kind.

Remember that electrical appliances can cause serious injury if used when you are wet or standing in water. If the telephone base should fall into water, DO NOT RETRIEVE IT UNTIL YOU UNPLUG THE POWER CORD AND TELEPHONE LINE CORDS FROM THE WALL. Pull the unit out by the unplugged cords.

Important safety information



This symbol is to alert you to important operating or servicing instructions that may appear in this user's manual. Always follow basic safety precautions when using this product to reduce the risk of injury, fire, or electric shock.

Safety information

- ▶ Read and understand all instructions in the user's manual. Observe all markings on the product.
- ▶ Avoid using a telephone during a thunderstorm. There may be a slight chance of electric shock from lightning.
- ▶ Do not use a telephone in the vicinity of a gas leak. Under certain circumstances, a spark may be created when the adapter is plugged into the power outlet, or when the handset is replaced in its cradle. This is a common event associated with the closing of any electrical circuit. In an inadequately ventilated environment, the user should not plug the phone into a power outlet, nor put a charged handset into the cradle where there are concentrations of flammable or flame-supporting gases. A spark in such an environment could create a fire or explosion. Such environments may include: medical use of oxygen without adequate ventilation; industrial gases (cleaning solvents; gasoline vapors; etc.); a leak of natural gas; etc.
- ▶ Do not use this product near water or when you are wet. For example, do not use it in a wet basement or shower, nor next to a swimming pool, bathtub, kitchen sink and laundry tub. Do not use liquids or aerosol sprays for cleaning. If the product comes in contact with any liquid, unplug any line or power cord immediately. Do not plug the product back in until it has dried thoroughly.
- ▶ Install this product in a protected location where no one can trip over any line or power cords. Protect cords from damage or abrasion.
- ▶ If this product does not operate normally, see the **Troubleshooting** section on pages 183-197 of this user's manual. If you cannot solve the problem, or if the product is damaged, refer to the **Limited warranty** section on pages 209-210. Do not open this product except as directed in your user's manual. Opening the product or reassembling it incorrectly may expose you to hazardous voltages or other risks.
- ▶ Replace batteries only, as described in your user's manual (pages 12-14). Do not burn or puncture batteries — they contain caustic chemicals.
- ▶ The power adapters are intended to be correctly oriented in a vertical or floor mount position. The prongs are not designed to hold the plug in place if it is plugged into a ceiling, under-the-table or cabinet outlet.
- ▶ For pluggable equipment, the socket-outlet shall be installed near the equipment and shall be easily accessible.



CAUTIONS:

- ▶ Use only the power adapters provided with this product. To obtain a replacement, visit our website at **www.telephones.att.com** or call **1 (800) 222-3111**. In Canada, dial **1 (866) 288-4268**.
- ▶ Use only the supplied rechargeable battery or replacement battery (model BT183342/BT283342). To order, visit our website at **www.telephones.att.com**, or call **1 (800) 222-3111**. In Canada, dial **1 (866) 288-4268**.
- ▶ To prevent risk of fire or battery explosion, replace with the correct battery type. Dispose of used batteries according to the instructions.

Important safety information

Especially about cordless telephones

- ▶ **Privacy:** The same features that make a cordless telephone convenient create some limitations. Telephone calls are transmitted between the telephone base and the handset by radio waves, so there is a possibility that your cordless telephone conversations could be intercepted by radio receiving equipment within range of the cordless handset. For this reason, you should not think of cordless telephone conversations as being as private as those on corded telephones.
- ▶ **Electrical power:** The telephone base of this cordless telephone must be connected to a working electrical outlet which is not controlled by a wall switch. Calls cannot be made from the handset if the telephone base is unplugged, switched off or if the electrical power is interrupted.
- ▶ **Potential TV interference:** Some cordless telephones operate at frequencies that may cause interference to TVs and VCRs. To minimize or prevent such interference, do not place the telephone base of the cordless telephone near or on top of a TV or VCR. If interference is experienced, moving the cordless telephone farther away from the TV or VCR will often reduce or eliminate the interference.
- ▶ **Rechargeable batteries:** This product contains nickel-metal hydride rechargeable batteries. Exercise care in handling batteries in order not to create a short circuit with conductive material such as rings, bracelets and keys. The battery or conductor may overheat and cause harm. Observe proper polarity between the battery and the battery charger.
- ▶ **Nickel-metal hydride rechargeable batteries:** Dispose of these batteries in a safe manner. Do not burn or puncture. Like other batteries of this type, if burned or punctured, they could release caustic material which could cause injury.



The RBRC Seal means that the manufacturer is voluntarily participating in an industry program to collect and recycle nickel-metal hydride rechargeable batteries when taken out of service within the United States. These batteries may be taken to a participating local retailer of replacement batteries or recycling center. You may call 1-800-8-BATTERY® for locations accepting spent Ni-MH batteries.

The RBRC Seal and 1-800-8-BATTERY® are registered trademarks of Call2recycle, Inc.

Important safety information

Precautions for users of implanted cardiac pacemakers

Cardiac pacemakers (applies only to digital cordless telephones):

Wireless Technology Research, LLC (WTR), an independent research entity, led a multidisciplinary evaluation of the interference between portable wireless telephones and implanted cardiac pacemakers. Supported by the U.S. Food and Drug Administration, WTR recommends to physicians that:

Pacemaker patients:

- ▶ Should keep wireless telephones at least six inches from the pacemaker.
- ▶ Should NOT place wireless telephones directly over the pacemaker, such as in a breast pocket, when it is turned ON.
- ▶ Should use the wireless telephone at the ear opposite the pacemaker.

WTR's evaluation did not identify any risk to bystanders with pacemakers from other persons using wireless telephones.

ECO mode

This power conserving technology reduces power consumption for optimal battery performance. The ECO mode activates automatically whenever the handset is synchronized with the telephone base.

Especially about telephone answering systems

Two-way recording: This unit does not sound warning beeps to inform the other party that the call is being recorded. To ensure that you are in compliance with any federal or state regulations regarding recording a telephone call, you should start the recording process and then inform the other party that you are recording the conversation.

SAVE THESE INSTRUCTIONS

For C-UL compliance

In compliance with the bilingual requirements for safety, caution, and warning markings of Canadian Federal and Provincial/Territorial statutes and regulations, the French version of Important safety information is included.

Mesures de sécurité importantes



Ce symbole vous alertera d'informations importantes ou d'instructions d'entretien pouvant apparaître dans ce guide d'utilisation. Respectez toujours les mesures de sécurité et de sécurité de base lorsque vous utilisez ce produit, afin de réduire les risques de blessures, d'incendie, ou d'électrocution.

Information relative à la sécurité

- Veuillez lire et comprendre toutes les instructions de ce guide d'utilisation. Relectez toutes les inscriptions apparaissant sur le produit.
- Évitez d'utiliser le téléphone pendant un orage. Il pourrait y avoir un faible risque d'électrocution.
- N'utilisez pas un téléphone près d'une fuite de gaz. Dans certaines circonstances, une flammèche pourrait se produire lorsque l'adaptateur est branché à une prise de courant, ou lorsque le combiné est déposé sur son chargeur. Ceci est un événement fréquent associé avec la fermeture d'un circuit électrique. L'utilisateur ne devrait pas brancher un téléphone dans une prise de courant, et ne devrait pas déposer un combiné chargé dans le chargeur, si le téléphone se trouve dans un environnement comportant une concentration de gaz inflammables ou ignifuges, à moins de se trouver dans un endroit où la ventilation est adéquate. Une flammèche dans de tels environnements pourrait provoquer une explosion. De tels environnements peuvent comprendre : les endroits où de l'oxygène à des fins médicales est utilisé sans ventilation adéquate; des endroits où se trouvent des gaz industriels (dissolvants de nettoyage, des vapeurs de gazoline, etc.), une fuite de gaz naturel, etc.
- N'utilisez pas ce produit près de l'eau ou lorsque vous êtes mouillés. Par exemple, ne l'utilisez pas dans des sous-sols humides ou sous la douche, ou près d'une piscine, d'un bain, d'un évier de cuisine, ou d'une cuve de lavage. N'utilisez pas de liquides, ou de vaporisateurs aérosol de nettoyage. Si le produit entre en contact avec du liquide, débranchez immédiatement le fil téléphonique ou le cordon d'alimentation. Ne rebranchez pas le produit avant qu'il soit complètement sec.
- Installez cet appareil dans un endroit protégé où personne ne peut trébucher sur les cordons d'alimentation ou la ligne téléphonique. Protégez les câbles contre les dommages ou l'abrasion.
- Si le produit ne fonctionne pas correctement, consultez la section **Dépannage (Troubleshooting)** des pages 183-197 de ce guide d'utilisation. Si vous ne pouvez pas régler le problème, ou si le produit est endommagé, consultez la section **Garantie limitée (Limited warranty)** des pages 209-210. N'ouvrez pas ce produit, sauf tel qu'indiqué dans le guide d'utilisation. L'ouverture du produit ou le remontage inadéquat pourrait vous exposer à des tensions dangereuses ou autres dangers.
- Remplacez les piles uniquement tel que décrit dans votre guide d'utilisation (pages 12-14). N'incinerez pas et ne percez pas les piles — elles contiennent des produits chimiques caustiques.
- Les adaptateurs secteurs sont conçus pour être orientés verticalement ou installés sur le plancher. Les broches ne sont pas conçues pour se maintenir en place si la fiche est branchée dans une prise de courant au plafond, sous la table ou sous une armoire.
- Pour les produits à brancher à une prise de courant, la prise de courant doit être installée près du produit, afin d'assurer une accessibilité sécuritaire à la prise de courant.

For C-UL compliance

**MISES EN GARDE:**

- N'utilisez que les adaptateurs inclus avec ce produit. Pour obtenir une pièce de rechange, visitez notre site Web au **www.telephones.att.com** ou composez le **1-800-222-3111**. Au Canada, composez le **1-866-288-4268**.
- N'utilisez que la pile de rechargeable incluse ou une pile de rechange (modèle BT183342/ BT283342). Pour commander, visitez notre site Web **www.telephones.att.com** ou composez le **1-800-222-3111**. Au Canada, composez le **1-866-288-4268**.
- Afin de prévenir les risques d'incendie ou d'explosion de la pile, remplacez la pile avec une pile du même type. Jetez les piles épuisées en respectant les instructions.

Spécifiquement en rapport avec les téléphones sans fil

- Confidentialité : Les mêmes caractéristiques qui rendent les téléphones sans fil si pratiques créent également des restrictions. Les appels téléphoniques sont transmis entre le socle du téléphone et le combiné par le biais d'ondes radio, et il se peut que vos conversations téléphoniques soient interceptées par d'autres équipements de réception d'ondes radio au sein de la portée du téléphone sans fil. Pour cette raison, vous ne devez pas considérer les conversations sur un téléphone sans fil comme étant aussi confidentielles que celles d'un téléphone à cordon.
- Alimentation électrique : La base de ce téléphone sans fil doit être branchée à une prise de courant électrique fonctionnelle. La prise électrique ne doit pas être contrôlée par un interrupteur mural. Les appels ne peuvent pas être effectués à partir du combiné si la base n'est pas branchée, si elle est hors fonction ou si le courant électrique est coupé.
- Interférences potentielles aux téléviseurs : Certains téléphones sans fil fonctionnent sur des fréquences pouvant causer des interférences aux téléviseurs et magnétoscopes. Pour réduire ou prévenir de tels parasites, ne pas déposer la base du téléphone sans fil à proximité d'un téléviseur ou magnétoscope, ni directement sur celui-ci. Si votre téléviseur affiche des interférences, éloignez le téléphone sans fil de celui-ci afin de réduire les parasites.
- Piles rechargeables : Ce produit comporte des piles rechargeables à l'hydrure métallique de nickel. Utilisez avec prudence lorsque vous manipulez de telles piles et veillez à ne pas les court-circuiter avec des matériaux conducteurs, tels que des bagues, bracelets et clés. La pile ou le conducteur peut surchauffer et vous brûler. Respectez la polarité adéquate entre les piles et le chargeur de piles.
- Piles rechargeables à l'hydrure métallique de nickel : Jetez ces piles de manière sécuritaire. N'incinerez pas et ne percez pas les piles. Comme pour les autres piles du même type, si elles sont brûlées ou percées, des matières corrosives peuvent s'en échapper, ce qui risque de causer des brûlures ou autres blessures corporelles.



Le sceau de l'organisme de recyclage RBRC sur les piles à l'hydrure métallique de nickel signifie que le fabricant de cet appareil participe volontairement au programme industriel visant à reprendre et recycler ce type de piles lorsqu'elles ne servent plus, au sein du territoire des États-Unis et du Canada. Vous devez apporter ces piles chez un détaillant participant ou le centre de recyclage le plus près de chez vous. Ou vous pouvez composer le 1-800-8-BATTERY^{MD} afin de connaître les endroits qui acceptent les piles à l'hydrure métallique de nickel mortes. RBRC et 1-800-8-BATTERY^{MD} sont des marques déposées de Call2recycle, Inc.

Appendix For C-UL compliance

Mesures préventives pour les utilisateurs de stimulateurs cardiaques implantés dans l'organisme

Stimulateurs cardiaques (ne s'applique qu'aux téléphones sans fil numériques) :

L'organisme 'Wireless Technology Research, LLC (WTR)', une firme de recherche indépendante, a mené une évaluation pluridisciplinaire des interférences entre les téléphones sans fil portatifs et les stimulateurs cardiaques implantés dans l'organisme. Appuyée par l'Administration des aliments et drogues (FDA) des États-unis, la firme WTR recommande aux médecins :

Avis aux détenteurs de stimulateurs cardiaques :

- ▶ Ils doivent tenir le téléphone sans fil à une distance d'au moins six pouces du stimulateur cardiaque.
- ▶ Ils ne doivent PAS placer le téléphone sans fil directement sur le stimulateur cardiaque, tel que dans une poche de chemise, lorsque celui-ci est en fonction.
- ▶ Ils doivent utiliser le téléphone sans fil en l'appuyant sur l'oreille qui se trouve dans la direction opposée au stimulateur cardiaque.

L'étude effectuée par l'organisme WRS n'a pas identifié de risque pour les détenteurs de simulateurs cardiaques causé par les gens qui utilisent un téléphone sans fil à proximité de ceux-ci.

Mode ECO

Lorsque le socle communique avec le combiné, le mode ECO sera activé automatiquement. Ceci réduit la consommation d'énergie selon la distance entre le socle du téléphone et le combiné.

Spécifiquement en rapport avec les répondeurs téléphoniques

Enregistrement deux voies : Cet appareil n'émet pas de bips d'avertissement qui permettent de prévenir l'autre partie que vous enregistrez la conversation. Pour assurer votre conformité aux règlements fédéraux ou provinciaux en rapport avec les enregistrements des conversations téléphoniques, vous devriez informer l'autre partie lorsque vous activez l'enregistrement.

CONSERVEZ CES INSTRUCTIONS

FCC Part 68 and ACTA

This equipment complies with Part 68 of the FCC rules and with technical requirements adopted by the Administrative Council for Terminal Attachments (ACTA). The label on the back or bottom of this equipment contains, among other things, a product identifier in the format US:AAAEQ##TXXXX. This identifier must be provided to your telephone service provider upon request.

The plug and jack used to connect this equipment to premises wiring and the telephone network must comply with the applicable Part 68 rules and technical requirements adopted by ACTA. A compliant telephone cord and modular plug is provided with this product. It is designed to be connected to a compatible modular jack that is also compliant. An RJ11 jack should normally be used for connecting to a single line and an RJ14 jack for two lines. See the installation instructions in the user's manual.

The Ringer Equivalence Number (REN) is used to determine how many devices you may connect to your telephone line and still have them ring when you are called. The REN for this product is encoded as the 6th and 7th characters following the US: in the product identifier (e.g., if ## is 03, the REN is 0.3). In most, but not all areas, the sum of all RENs should be five (5.0) or less. For more information, please contact your telephone service provider.

This equipment must not be used with Party Lines. If you have specially wired alarm dialing equipment connected to your telephone line, ensure the connection of this equipment does not disable your alarm equipment. If you have questions about what will disable the alarm equipment, consult your telephone service provider or a qualified installer.

If this equipment is malfunctioning, it must be unplugged from the modular jack until the problem has been corrected. Replacement to this telephone equipment can only be made by the manufacturer or its authorized agents. For replacement procedures, follow the instructions outlined under the Limited warranty.

If this equipment is causing harm to the telephone network, the telephone service provider may temporarily discontinue your telephone service. The telephone service provider is required to notify you before interrupting service. If advance notice is not practical, you will be notified as soon as possible. You will be given the opportunity to correct the problem and the telephone service provider is required to inform you of your right to file a complaint with the FCC. Your telephone service provider may make changes in its facilities, equipment, operation, or procedures that could affect the proper functioning of this product. The telephone service provider is required to notify you if such changes are planned.

If this product is equipped with a corded or cordless handset, it is hearing aid compatible.

If this product has memory dialing locations, you may choose to store emergency telephone numbers (e.g., police, fire, medical) in these locations. If you do store or test emergency numbers, please:

Remain on the line and briefly explain the reason for the call before hanging up.

Perform such activities in off-peak hours such as early morning or late evening.

Industry Canada

This device complies with Industry Canada licence-exempt RSS standard(s).

Operation is subject to the following two conditions: (1) this device may not cause harmful interference, and (2) this device must accept any interference received, including interference that may cause undesired operation.

Privacy of communications may not be ensured when using this telephone.

The term "IC:" before the certification/registration number only signifies that the Industry Canada technical specifications were met.

The Ringer Equivalence Number (REN) for this terminal equipment is 1.0. The REN is an indication of the maximum number of devices allowed to be connected to a telephone interface. The termination on an interface may consist of any combination of devices subject only to the requirement that the sum of the RENs of all the devices does not exceed five.

This product meets the applicable Innovation, Science and Economic Development Canada technical specifications

Appendix

FCC Part 15

This equipment has been tested and found to comply with the requirements for a Class B digital device under Part 15 of the Federal Communications Commission (FCC) rules. These requirements are intended to provide reasonable protection against harmful interference in a residential installation. This equipment generates, uses and can radiate radio frequency energy and, if not installed and used in accordance with the instructions, may cause harmful interference to radio communications. However, there is no guarantee that interference will not occur in a particular installation. If this equipment does cause harmful interference to radio or television reception, which can be determined by turning the equipment off and on, the user is encouraged to try to correct the interference by one or more of the following measures:

- ▶ Reorient or relocate the receiving antenna.
- ▶ Increase the separation between the equipment and receiver.
- ▶ Connect the equipment into an outlet on a circuit different from that to which the receiver is connected.
- ▶ Consult the dealer or an experienced radio/TV technician for help.

Changes or modifications to this equipment not expressly approved by the party responsible for compliance could void the user's authority to operate the equipment.

This device complies with Part 15 of the FCC Rules. Operation is subject to the following two conditions: (1) this device may not cause harmful interference, and (2) this device must accept any interference received, including interference that may cause undesired operation. Privacy of communications may not be ensured when using this telephone.

To ensure safety of users, the FCC has established criteria for the amount of radio frequency energy that can be safely absorbed by a user or bystander according to the intended usage of the product. This product has been tested and found to comply with the FCC criteria. The handset may be safely held against the ear of the user. The telephone base shall be installed and used such that parts of the user's body other than the hands are maintained at a distance of approximately 20 cm (8 inches) or more.



This Class B digital apparatus complies with Canadian requirement:

CAN ICES-3 (B)/NMB-3(B)

California Energy Commission battery charging testing instructions

This telephone is set up to comply with the energy-conserving standards right out of the box. These instructions are intended for California Energy Commission (CEC) compliance testing only. When the CEC battery charging testing mode is activated, all telephone functions, except battery charging, will be disabled.

To activate the CEC battery charging testing mode:

1. Unplug the telephone base power adapter from the power outlet. Make sure all cordless handsets are inserted with charged batteries and out of the chargers before proceeding.
2. While you press and hold  /**HANDSET LOCATOR**, plug the telephone base power adapter back to the power outlet.
3. After about 20 seconds, when the **HOME** light starts flashing, release  /**HANDSET LOCATOR** and then press it again within two seconds. You hear a confirmation tone. The **HOME** light turns off and all handsets display **To register HS, see manual.** Allow up to one minute for the process to complete.



If the phone fails to enter this mode, repeat all the steps mentioned above. The telephone base will be powered up as normal if you fail to press  /**HANDSET LOCATOR** within two seconds in Step 3.

To deactivate the CEC battery charging testing mode:

1. Unplug the telephone base power adapter from the power outlet, then plug it back in. The telephone base is powered up as normal.
2. Register your handsets back to the telephone base. See pages 170-171 for handset registration instructions.

Limited manufacturer's warranty

The AT&T brands are used under license. This product is covered by a one-year limited warranty. Any replacement or warranty service, and all questions about this product, should be directed to our website at **www.telephones.att.com** or call **1 (800) 222-3111**. In Canada, dial **1 (866) 288-4268**.

1. What does this limited warranty cover?

The manufacturer of this AT&T Product, Advanced American Telephones, warrants to the holder of a valid proof of purchase ("Consumer" or "you") that the Product and all accessories provided by Advanced American Telephones in the sales package ("Product") are free from material defects in material and workmanship, pursuant to the following terms and conditions, when installed and used normally and in accordance with operation instructions. This limited warranty extends only to the Consumer for Products purchased and used in the United States of America and Canada.

2. What will Advanced American Telephones do if the Product is not free from material defects in materials and workmanship during the limited warranty period ("Materially Defective Product")?

During the limited warranty period, Advanced American Telephones' authorized service representative will replace, at Advanced American Telephones' option, without charge, a Materially Defective Product. If we choose to replace this Product, we may replace it with a new or refurbished Product of the same or similar design. Advanced American Telephones will return replacement Products to you in working condition.

Advanced American Telephones will retain defective parts, modules, or equipment. Replacement of Product, at Advanced American Telephones' option, is your exclusive remedy. You should expect the replacement to take approximately 30 days.

3. How long is the limited warranty period?

The limited warranty period for SynJ[®] and Syn248[®] products is TWO (2) YEARS from the date of purchase, while all other products limited warranty period is ONE (1) YEAR from the date of purchase. If we replace a Materially Defective Product under the terms of this limited warranty, this limited warranty also applies to replacement Products for a period of either (a) 90 days from the date the replacement Product is shipped to you or (b) the time remaining on the original one-year limited warranty, whichever is longer.

4. What is not covered by this limited warranty?

This limited warranty does not cover:

- ▶ Product that has been subjected to misuse, accident, shipping or other physical damage, improper installation, abnormal operation or handling, neglect, inundation, fire, water or other liquid intrusion; or
- ▶ Product that has been damaged due to repair, alteration or modification by anyone other than an authorized service representative of Advanced American Telephones; or
- ▶ Product to the extent that the problem experienced is caused by signal conditions, network reliability or cable or antenna systems; or
- ▶ Product to the extent that the problem is caused by use with non-Advanced American Telephones electrical accessories; or
- ▶ Product whose warranty/quality stickers, Product serial numbers plates or electronic serial numbers have been removed, altered or rendered illegible; or
- ▶ Product purchased, used, serviced, or shipped for repair from outside the United States, or used for commercial or institutional purposes (including but not limited to Products used for rental purposes); or

Limited manufacturer's warranty

- ▶ Product returned without valid proof of purchase (see 2 below); or
- ▶ Charges for installation or set up, adjustment of customer controls, and installation or repair of systems outside the unit.

5. How do you get warranty service?

To obtain warranty service, visit our website at www.telephones.att.com or call **1 (800) 222-3111**. In Canada, dial **1 (866) 288-4268**.

Note: Before calling for service, please review the user's manual; a check of the Product controls and features may save you a service call.

Except as provided by applicable law, you assume the risk of loss or damage during transit and transportation and are responsible for delivery or handling charges incurred in the transport of Product(s) to the service location. Advanced American Telephones will return replaced Product under this limited warranty to you, transportation, delivery or handling charges prepaid. Advanced American Telephones assumes no risk for damage or loss of the Product in transit.

6. What must you return with the PRODUCT to get warranty service?

You must:

1. Return the entire original package and contents including the Product to the Advanced American Telephones service location along with a description of the malfunction or difficulty;
2. Include "valid proof of purchase" (sales receipt) identifying the Product purchased (Product model) and the date of purchase or receipt; and
3. Provide your name, complete and correct mailing address and telephone number.

7. Other limitations

This warranty is the complete and exclusive agreement between you and Advanced American Telephones. It supersedes all other written or oral communications related to this Product. Advanced American Telephones provides no other warranties for this Product. The warranty exclusively describes all of Advanced American Telephones' responsibilities regarding the Product. There are no other express warranties. No one is authorized to make modifications to this limited warranty and you should not rely on any such modification.

State/Provincial Law rights: This warranty gives you specific legal rights, and you may also have other rights which vary from state to state or province to province.

Limitations: Implied warranties, including those of fitness for a particular purpose and merchantability (an unwritten warranty that the Product is fit for ordinary use) are limited to one year from date of purchase. Some states/provinces do not allow limitations on how long an implied warranty lasts, so the above limitation may not apply to you.

Implied warranties, including those of fitness for a particular purpose and merchantability (an unwritten warranty that the Product is fit for ordinary use) are limited to one year from date of purchase. Some states/provinces do not allow limitations on how long an implied warranty lasts, so the limitation mentioned above may not apply to you.

In no event shall Advanced American Telephones be liable for any indirect, special, incidental, consequential, or similar damages (including, but not limited to lost profits or revenue, inability to use the Product, or other associated equipment, the cost of substitute equipment, and claims by third parties) resulting from the use of this Product. Some states/provinces do not allow the exclusion or limitation of incidental or consequential damages, so the above limitation or exclusion may not apply to you.

Please retain your original sales receipt as proof of purchase.

Technical specifications

RF frequency band	1921.536MHz - 1928.448MHz
Channels	5
Telephone base voltage (AC voltage, 60Hz)	96Vrms - 129Vrms
Telephone base voltage (AC adapter output)	6VDC @ 600mA 5.1VDC @ 1000mA
Handset voltage	2.4 VDC, AAA×2, Ni-MH battery pack
Charger voltage (AC adapter output)	6VDC @ 400mA

Operation	Operating time*
Talk time (cordless handset)	Up to 7 hours
Standby	Up to 7 days

* Operating times vary depending on your actual use and the age of the battery.

DECT 6.0 digital technology

The AT&T DECT 6.0 products offer unsurpassed range performance and sound clarity. This is achieved through a unique antenna design and advances in noise-filtering technology. An independent laboratory has confirmed that AT&T DECT 6.0 products perform up to 45% better in range competitions against similarly equipped phones of the leading competition. Now, calls can be taken in the basement, backyard and garage with exceptional sound quality.

Telephone operating range

This cordless telephone operates within the maximum power allowed by the Federal Communications Commission (FCC). Even so, this handset and telephone base can communicate over a certain distance — which can vary with the locations of the telephone base and handset, the weather, and the construction of your home or office.

Redefining long range coverage and clarity

This telephone base comes with an antenna which gives much better clarity and covers a longer range than before.

HD audio

HD audio improves sound quality by expanding and rebuilding frequencies that are lost with traditional phone calls. There is no additional telephone service requirement to use HD audio. It is designed to work with standard telephone service. Your system will automatically enhance all received sound with HD audio.

Simulated full-duplex handset and base speakerphones

The simulated full-duplex speakerphone on your handset and telephone base allow both ends of a call to speak and be heard at the same time. Optimal performance is subject to external factors and individual usage.

A

- Active devices 26, 29
- Add a bluetooth headset 24–25
- Add a cell phone 22–23
- Add a handset 170–171
- Alerts manager 20
- Alert tones
 - handset 175
 - telephone base 176
- Allow list 122
- Announcement 148
- Answer an incoming call
 - during an intercom call 75
 - during PTT 84
- Answer calls 53, 55
- Answering system 148–169

B

- Battery backup mode 15
- Battery charging 12–14
- Battery installation 12–14
- Block list 116
- Bluetooth 18–37
- Bluetooth connection from idle mode 26
- Bluetooth features 18–20
- Bluetooth glossary 21
- Bluetooth setup 22–34

C

- Caller ID announce 43
- Caller ID (CID)
 - add entries to phone directory 101
 - dial entries 100
 - review entries 99
- Caller ID manager 20
- Call intercept 163

- Calls without numbers 109
- Call transfer 76–77
- Cell area code 49
- Cell call 55
- Cell phone download
 - directory 30–31
- Cell ringer 34
- Chain dialing 63–65
- Change PIN 34
- Charger installation 11
- Clear voicemail indication 45
- Clock 41–42
- Connect an active device 27
- Connect to Cell 20

D

- Date and time 41–42
- Delete
 - a caller ID log entry 106
 - a directory entry 95
 - a redial entry 70
- Dialing
 - from a record in the caller ID log 100
- Directory
 - edit entries 93–94
 - name search 92
 - new entries 87–88
- Disconnect an active device 27
- Display screen message 178–182
- DSL 1, 10

E

- Elapsed time 53
- End a cell call 55
- End a home call 53
- Equalizer 63

H

- Handset
 - handset locator 71
 - quick reference guide 2–5
 - ringer tone 40
 - ringer volume 39
 - screen icons 173
 - speakerphone 60
 - temporary ringer silencing 61
 - voicemail indication 45
- HD audio 211
- Home area code 48

I

- Important safety
 - information 200–202
- Installation 10–14
- Intercom 73–77
- Interruption to directory
 - download 32

L

- Last number redial 66
- LCD language 42
- Lights 177
- Limited warranty 209–210

M

- Maintenance 199
- Make a cell call 55
- Make a home call 53
- Make an outgoing call during PTT 85
- Memory match 98

- Message
 - alert tone 158
 - capacity 161
 - playback 164–166
- Mute 61

N

- No line alert 52
- Number of rings 156

O

- Operating range 211
- Outgoing announcement 148

P

- Paging tone 71
- Phonebook 86
- Power adapter 10, 11
- Predialing 53, 55
- Push-to-talk 78–85

Q

- Quick reference guide 2–9
- Quiet mode 51

R

- Receiving calls 53–58
- Recharging 13
- Redial 66–70
- Remote access 157, 168–169
- Remote voice control 35–37
- Replace an active device 29
- Ringer silencing 61
- Ringer tone options 40

Index

S

- Safety information 200–202
- Search for a contact 92
- Share an outside call 72
- Smart call blocker 108–146
 - allowed calls 136–137
 - blocked calls 138–139
 - call controls 110
 - control home calls without numbers 112
 - control uncategorized home calls 114
 - option while on a call 147
 - screen home calls without numbers 140–142
 - screening announcements 132
 - screen uncategorized home calls 143–146
 - set Smart call blocker on/off 112
- Speakerphone 60
- Star name list 128
- Stop message playback 165

T

- Technical specifications 211
- Telephone base
 - quick reference guide 6–9
 - ringer tone 40
 - ringer volume 39
 - screen icons 174
 - voicemail indicator 45
- Temporary ringer silencing 61
- Time 41–42
- Troubleshooting 183–197

U

- Uncategorized calls 109
- Unwelcome calls 109
- USB port 8

V

- View the directory download information 33
- Voice announce caller ID 43
- Voice control 35–37
- Voice guide 135, 154
- Voice guide to set Answering system 154
- Voice guide to set Smart call blocker 135
- Voicemail 44, 45, 160, 161
- Volume control 60

W

- Wall-mount installation 16
- Warranty 209–210
- Welcome calls 109

Remote access wallet card

Use the wallet card, as shown below, to help you remember commands to control your answering system from any touch-tone telephone.

Cut along dotted line.



Call your phone number, then enter your two-digit access code (preset to **19**).

Action	Remote command
--------	----------------

Play all messages.....	1
Play new messages.....	2
Delete the message	3
Delete all old messages.....	33
Repeat or go back.....	4
Stop	5
Help menu.....	*5

Fold here.

Skip the message.....	6
Record announcement.....	*7
End remote access call	8 (or hang up)
Turn system off or on	0

Models: CLP99287/CLP99387/CLP99447/CLP99457/CLP99487/CLP99547/CLP99557/CLP99587

Type: **DECT 6.0 cordless telephone/answering system with caller ID/call waiting**

© 2017-2021 Advanced American Telephones. All Rights Reserved.
AT&T and the AT&T logo are trademarks of AT&T Intellectual Property licensed to Advanced American Telephones, San Antonio, TX 78219.
Printed in China.



www.telephones.att.com

The *Bluetooth*® word mark and logos are owned by Bluetooth SIG, Inc. and any use of such marks by Advanced American Telephones and its parent, VTech Holdings Limited, is under license. VTech Holdings Limited is a member of Bluetooth SIG, Inc. Other trademarks and trade names are those of their respective owners.

© 2017-2021 Advanced American Telephones. All Rights Reserved.

AT&T and the AT&T logo are trademarks of AT&T Intellectual Property licensed to

Advanced American Telephones, San Antonio, TX 78219.

iPhone® and Siri® are registered trademarks of Apple Inc.

iOS is a trademark or registered trademark of Cisco in the U.S. and other countries and is used under license.

Connect to Cell™ is a trademark of Advanced American Telephones.

Android® and Google Play® are registered trademarks of Google Inc.

Google Now™ is a trademark of Google Inc.

Qaltel™ is a trademark of Truecall Group Limited.

S Voice® is a registered mark of Samsung Electronics Co., Ltd.

The RBRC Seal and 1-800-8-BATTERY® are registered trademarks of Call2recycle, Inc.

Printed in China. Issue 5.0 AT&T 05/21.