

# vtech®

## Complete user's manual

[www.vtechphones.com](http://www.vtechphones.com)



Models:  
CS6629/CS6629-2/  
CS6629-3

**DECT 6.0**

# Congratulations

on purchasing your new VTech product. Before using this telephone, please read **Important safety instructions** on page 68 of this manual.

This manual has all the feature operations and troubleshooting necessary to install and operate your new VTech telephone. Please review this manual thoroughly to ensure proper installation and operation of this innovative and feature rich VTech product. For support, shopping, and everything new at VTech, visit our website at [www.vtechphones.com](http://www.vtechphones.com). In Canada, please visit [www.vtechcanada.com](http://www.vtechcanada.com).



The ENERGY STAR<sup>®</sup> program ([www.energystar.gov](http://www.energystar.gov)) recognizes and encourages the use of products that save energy and help protect our environment. We are proud to mark this product with the ENERGY STAR<sup>®</sup> label indicating it meets the latest energy efficiency guidelines.



Telephones identified with this logo have reduced noise and interference when used with most T-coil equipped hearing aids and cochlear implants. The TIA-1083 Compliant Logo is a trademark of the Telecommunications Industry Association. Used under license.

# Table of contents

<b>Getting started</b> . . . . .	<b>1</b>	Redial . . . . .	21
Parts checklist . . . . .	1	Check voicemail . . . . .	22
Telephone base and charger installation . . . . .	2	Chain dialing. . . . .	22
Battery installation . . . . .	3	Web address . . . . .	23
Battery charging . . . . .	4	Transfer a call. . . . .	23
Installation options . . . . .	5	Find handset. . . . .	24
Tabletop to wall mount installation . . . . .	5	<b>Multiple handset use</b> . . . . .	<b>25</b>
Wall mount to tabletop installation . . . . .	6	Join a call in progress . . . . .	25
Telephone base layout. . . . .	7	Intercom . . . . .	26
Handset layout . . . . .	8	Answer an incoming call during an intercom call . . . . .	26
<b>Telephone settings.</b> . . . . .	<b>10</b>	Call transfer using intercom . . . . .	27
Using the menu . . . . .	10	<b>Directory</b> . . . . .	<b>28</b>
Handset ringer volume . . . . .	10	About the directory . . . . .	28
Telephone base ringer volume. . . . .	11	Add a directory entry . . . . .	29
Ringer tone. . . . .	11	Review and dial from the directory. . . . .	31
Quiet mode . . . . .	12	Alphabetical search . . . . .	31
Set date and time . . . . .	13	Edit a directory entry. . . . .	32
LCD language. . . . .	14	Delete a directory entry . . . . .	32
Voicemail number. . . . .	15	Speed dial. . . . .	33
Clear voicemail. . . . .	16	Assign a speed dial entry . . . . .	33
Key tone . . . . .	17	Reassign a speed dial entry . . . . .	34
Home area code. . . . .	17	Dial a speed dial number . . . . .	34
Dial mode . . . . .	18	Delete a speed dial entry . . . . .	34
<b>Telephone operation</b> . . . . .	<b>19</b>	<b>Caller ID.</b> . . . . .	<b>35</b>
Make a call . . . . .	19	About caller ID . . . . .	35
Predial a call. . . . .	19	Information about caller ID with call waiting . . . . .	35
Answer a call . . . . .	19	Caller ID log . . . . .	36
End a call . . . . .	19	Missed call indicator. . . . .	36
Speakerphone . . . . .	19	Memory match . . . . .	37
Volume . . . . .	20	Review and dial from the caller ID log . . . . .	37
Mute . . . . .	20	View dialing options . . . . .	38
Call waiting. . . . .	20		
Temporary ringer silencing. . . . .	20		
Temporary tone dialing. . . . .	21		

# Table of contents

Save a caller ID log entry to the directory . . . . .	39	Handset and telephone base indicators . . . . .	58
Delete the caller ID log entries . . . . .	40	Battery . . . . .	59
Caller ID log screen messages. . . . .	40	Troubleshooting . . . . .	60
<b>Answering system settings . . . . .</b>	<b>41</b>	Important safety instructions. . . . .	68
Answering system . . . . .	41	Precautions for users of implanted cardiac pacemakers . . . . .	69
Announcement . . . . .	41	Operating range . . . . .	69
Record your own announcement . . . . .	41	ECO mode . . . . .	69
Play the announcement . . . . .	42	Maintenance. . . . .	70
Delete your announcement . . . . .	42	About cordless telephones . . . . .	71
Answer on/off . . . . .	43	The RBRC <sup>®</sup> seal. . . . .	71
Call screening. . . . .	44	Limited warranty . . . . .	72
Number of rings . . . . .	44	FCC, ACTA and IC regulations . . . . .	74
Remote access code . . . . .	45	Technical specifications . . . . .	75
Message alert tone. . . . .	45		
Recording time . . . . .	46	<b>Index . . . . .</b>	<b>76</b>
<b>Answering system operation . . . . .</b>	<b>47</b>		
Answering system and voicemail . . . . .	47		
Using the answering system and voicemail together . . . . .	47		
Message capacity. . . . .	48		
New message indication. . . . .	48		
Call screening. . . . .	49		
Call intercept. . . . .	49		
Message playback . . . . .	50		
Delete all messages . . . . .	51		
Record, play or delete memos . . . . .	51		
Message window displays . . . . .	52		
Remote access. . . . .	53		
<b>Appendix . . . . .</b>	<b>54</b>		
Expand your telephone system . . . . .	54		
Add and register a handset . . . . .	54		
Replace a handset . . . . .	55		
Screen messages. . . . .	56		

# Getting started

## Parts checklist

Your telephone contains the following items. Save your sales receipt and original packaging in the event warranty service is necessary.



Handset  
(1 for CS6629)  
(2 for CS6629-2)  
(3 for CS6629-3)

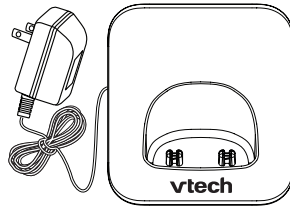

Charger and  
charger adapter  
(1 for CS6629-2)  
(2 for CS6629-3)

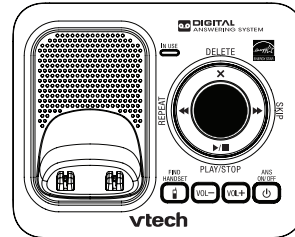

Telephone base

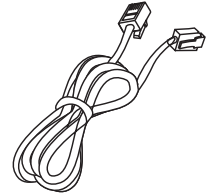

Telephone  
line cord

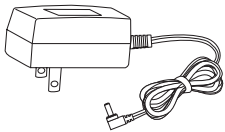

Telephone base  
power adapter



Battery compartment cover  
(1 for CS6629)  
(2 for CS6629-2)  
(3 for CS6629-3)



Battery  
(1 for CS6629)  
(2 for CS6629-2)  
(3 for CS6629-3)

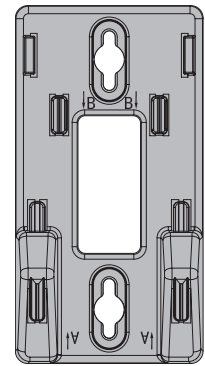

Wall mount bracket

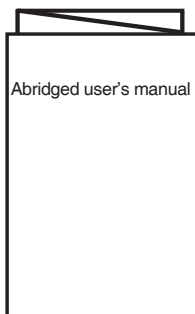

Abridged user's manual

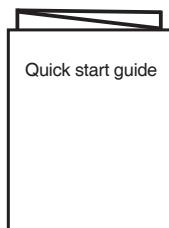

Quick start guide

### note

To purchase a replacement battery or power adapter, visit our website at [www.vtechphones.com](http://www.vtechphones.com) or call 1 (800) 595-9511. In Canada, go to [www.vtechcanada.com](http://www.vtechcanada.com) or call 1 (800) 267-7377.

# Getting started

## Telephone base and charger installation

Install the telephone base and charger as shown below.

If you subscribe to digital subscriber line (DSL) high-speed Internet service through your telephone line, you must install a DSL filter between the telephone line cord and telephone wall jack. Contact your DSL service provider for more information about DSL filter.

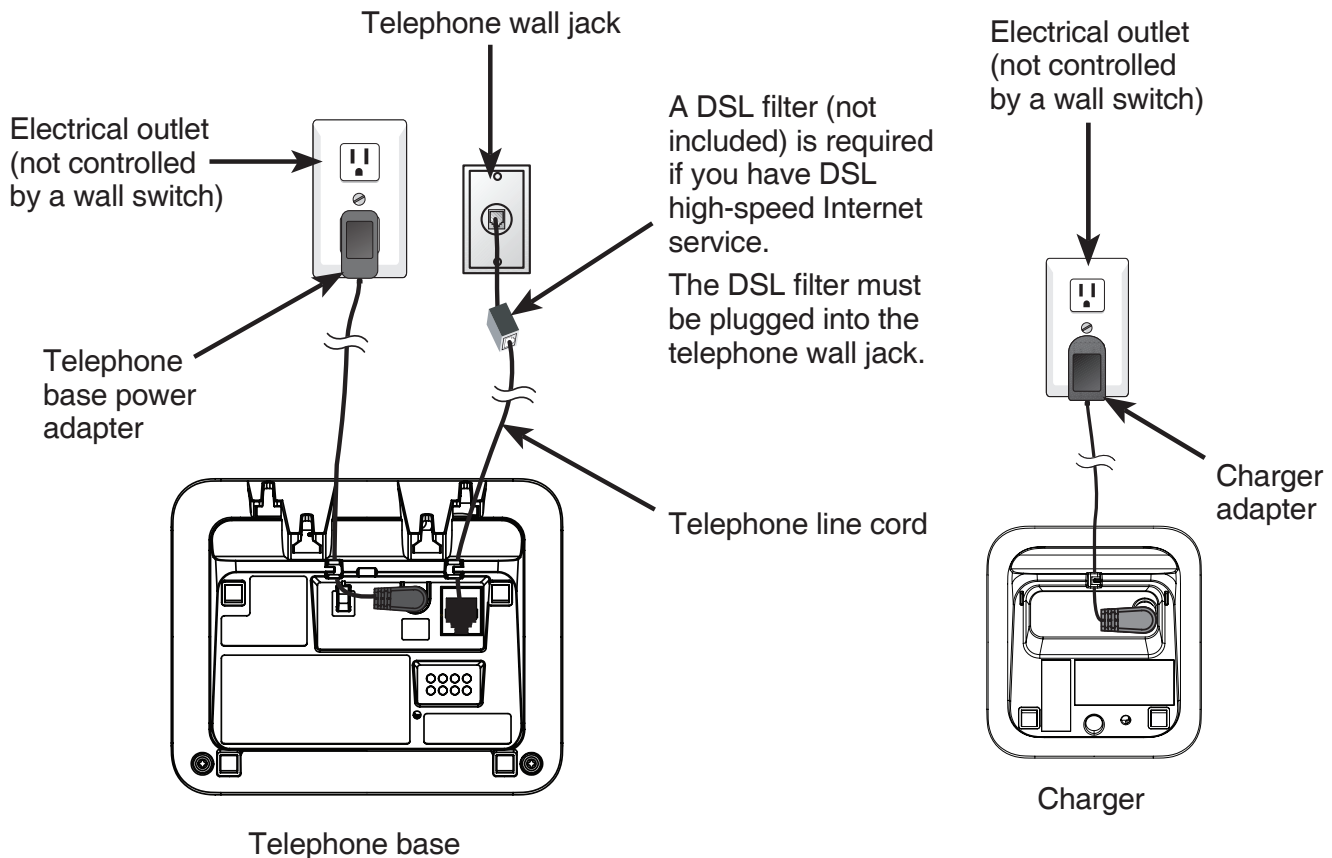

### note

- Use only the power adapters supplied with this product. To order a replacement, visit our website at [www.vtechphones.com](http://www.vtechphones.com) or call 1 (800) 595-9511. In Canada, go to [www.vtechcanada.com](http://www.vtechcanada.com) or call 1 (800) 267-7377.
- The power adapters are intended to be correctly oriented in a vertical or floor mount position. The prongs are not designed to hold the plug in place if it is plugged into a ceiling, under-the-table or cabinet outlet.

# Getting started

## Battery installation

Install the battery as shown below.

1. Plug the battery connector securely into the socket, matching the orientation of the engraved label.

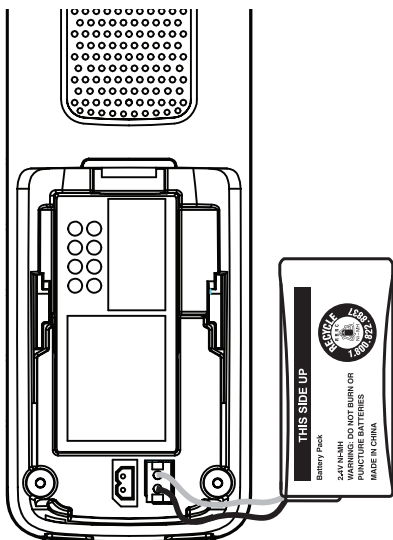

2. Place the battery with the label **THIS SIDE UP** facing up and the wires inside the battery compartment.



3. Slide the battery compartment cover towards the center of the handset until it clicks into place.

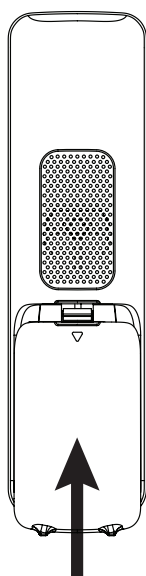

4. Place the handset in the telephone base or charger to charge.

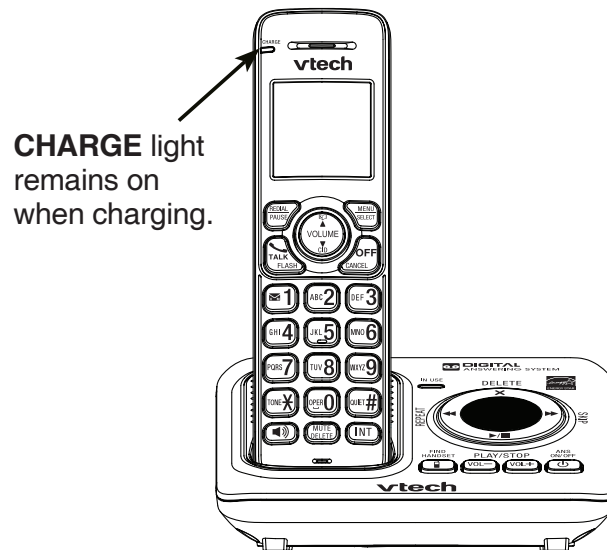

### note

- If the handset will not be used for a long period of time, disconnect and remove the battery to prevent any possible leakage.
- To purchase replacement batteries, visit our website at [www.vtechphones.com](http://www.vtechphones.com) or call 1 (800) 595-9511. In Canada, go to [www.vtechcanada.com](http://www.vtechcanada.com) or call 1 (800) 267-7377.



# Getting started

## Battery charging

Once you have installed the battery, the screen indicates the battery status (see the table below). If necessary, place the handset in the telephone base or charger to charge the battery. For best performance, keep the handset in the telephone base or charger when not in use. The battery is fully charged after 11 hours of continuous charging. See the table on page 59 for battery operating times.

If the screen is blank or displays **Put in charger**, you need to charge the handset without interruption for at least 30 minutes to give the handset enough charge to use for a short time. When the battery is low, the handset displays **Low battery** along with a flashing  icon. If you are on a call in low battery mode, the handset plays short beeps to alert you.

The following table summarizes the battery charge indicators and actions to take.

Battery indicators	Battery status	Action
The screen is blank, or displays <b>Put in charger</b> and  flashes.	The battery has no or very little charge. The handset cannot be used.	Charge without interruption (at least 30 minutes).
The screen displays <b>Low battery</b> and  flashes.	The battery has enough charge to be used for a short time.	Charge without interruption (about 30 minutes).
The screen displays <b>HANDSET X.</b>	The battery is charged.	To keep the battery charged, place it in the telephone base or charger when not in use.

**note** If you place the handset in the telephone base or charger without plugging in a battery, the screen displays **NO BATTERY.**

After you install your telephone or power returns following a power outage, the handset will prompt you to set the date and time. For instructions, see **Set date and time** on page 13. To skip setting, press **CANCEL.**





# Getting started

## Installation options

The telephone comes ready for tabletop use. If you want to mount your telephone on a wall, use the provided wall mount bracket to connect with a standard dual-stud telephone wall mount plate. If you do not have this wall mount plate, you can purchase one from many hardware or consumer electronics retailers. You may need a professional to install the wall mount plate.

## Tabletop to wall mount installation

1. Remove the telephone line cord from the telephone wall jack, and the telephone base power adapter from the electrical outlet (if necessary).

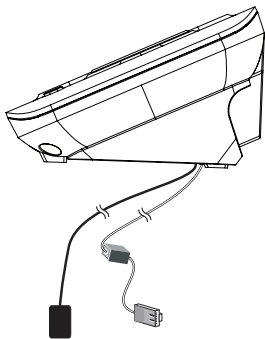

2. Position the telephone base against the wall mount bracket with the extended tabs marked **B** on top. Insert the extended tabs marked **B** on the wall mount bracket into the slots marked **B** on the back of the telephone base. Push the telephone base down until it clicks securely.

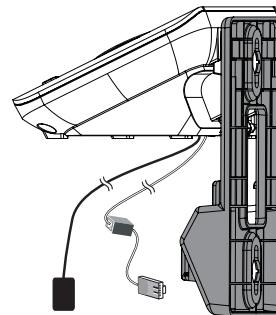

3. Route the telephone line cord through the hole on the wall mount bracket and plug it into the telephone wall jack. Route the power cord out of the telephone base and plug it into an electrical outlet not controlled by a wall switch.

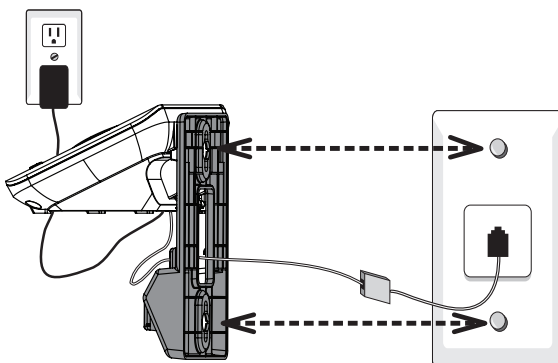

4. Align the holes on the bracket with the standard wall plate and slide the bracket down until it locks securely. Bundle the telephone line cord and power adapter cord neatly with twist ties.

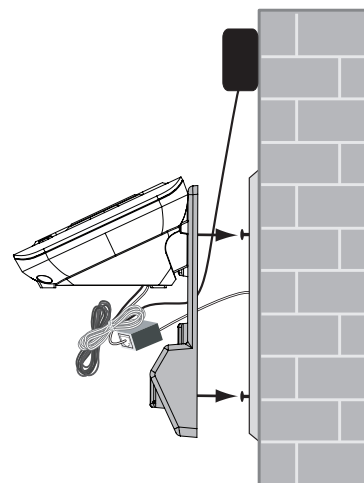

# Getting started

## Wall mount to tabletop installation

1. If the telephone line cord and power adapter cord are bundled, untie them first.
2. Slide the wall mount bracket up and remove it from the wall mount plate. Unplug the telephone line cord (or DSL filter) from the telephone wall jack. Unplug the power adapter from the power outlet.
3. Slide the telephone base up and remove it from the wall mount bracket.
4. See **Telephone base and charger installation** on page 2.

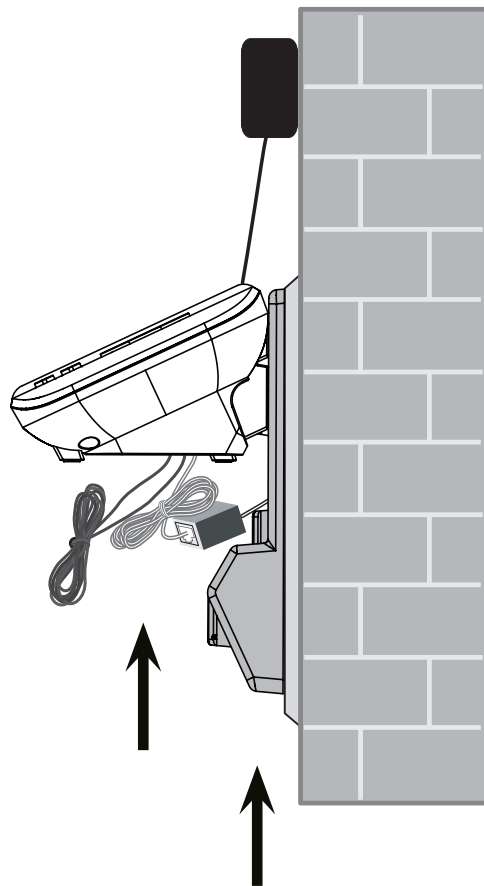

# Getting started

## Telephone base layout

### IN USE light

- Flashes when there is an incoming call, or another telephone sharing the same line is in use.
- Flashes when handsets are being deregistered.
- On when a handset is in use.
- On when the answering system is answering a call.
- On when a handset is being registered.

### ◀/REPEAT

- Press to repeat the playing message (page 50).
- Press twice to play the previous message (page 50).

### ▶/■/PLAY/STOP

- Press to play messages (page 50).
- Press to stop message playback (page 50).

### 📞/FIND HANDSET

- Press to page all system handsets (page 24).

### Message window

- Shows the number of messages, and other information of the answering system or telephone base (page 52).

### X/DELETE

- Press to delete the message currently playing (page 50).
- When the telephone is not in use, press twice to delete all previously reviewed messages (page 51).

### ▶/SKIP

- Press to skip to the next message (page 50).

### 🔌/ANS ON/OFF

- Press to turn the answering system on or off (page 43).

### VOL- and VOL+

- Press to adjust the volume during message playback (page 50).
- When the phone is not in use, press to adjust the telephone base ringer volume (page 11).

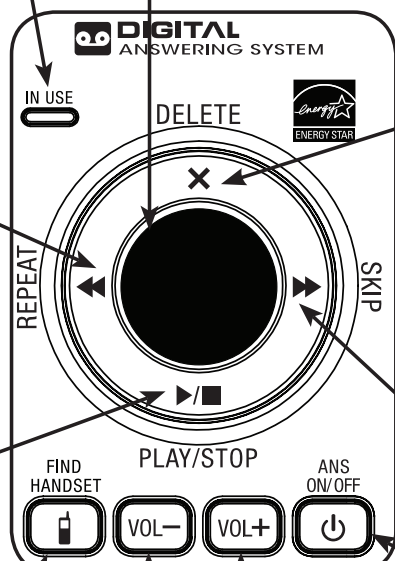

# Getting started

## Handset layout

### CHARGE light

- On when the handset is charging in the telephone base or charger (page 3).

### **VOLUME**

- Press to review the directory when the phone is not in use (page 31).
- During a call or message playback, press to increase the listening volume (page 20 or page 50).
- Press to scroll up while in a menu, or reviewing the directory, caller ID log or redial list.
- While entering numbers or names in the directory, press to move the cursor to the right.

### **REDIAL/PAUSE**

- Press repeatedly to review the last 10 numbers dialed (page 21).
- While dialing or entering numbers, press and hold to insert a dialing pause (page 19 or page 29).

### **TALK/FLASH**

- Press to make or answer a call (page 19).
- During a call, press to answer an incoming call when you receive a call waiting alert (page 20).

### **1**

- While reviewing a caller ID log entry, press repeatedly to add or remove 1 in front of the caller ID log entry before dialing or saving it to the directory (page 38).
- Press and hold to set or dial your voicemail number (page 15 and page 22).

### **Dialing keys**

- Press to enter numbers or characters.
- Press to answer an incoming call (page 19).

### **tone**

- While on a call, press to switch to tone dialing temporarily when using pulse service (page 21).

### 

- Press to make or answer a call using the handset speakerphone (page 19).
- During a call, press to switch between the handset speakerphone and the cordless handset (page 19).

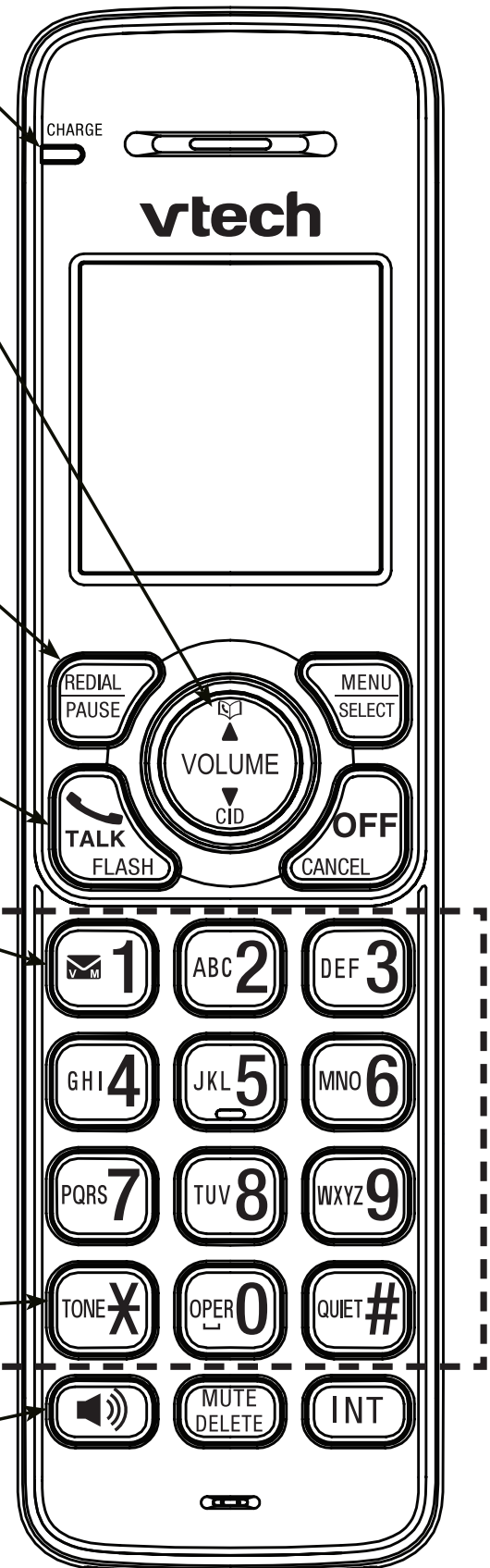

# Getting started

## Handset layout

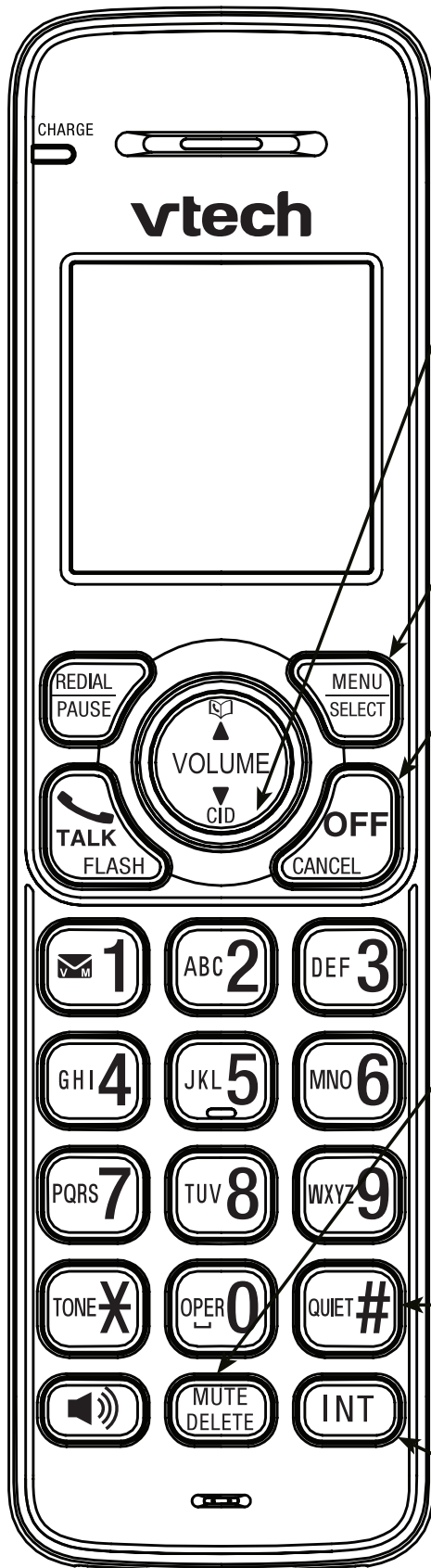

### CID/▼/VOLUME

- Press to review the caller ID log when the phone is not in use (page 37).
- During a call or message playback, press to decrease the listening volume (page 20 or page 50).
- Press to scroll down while in a menu, or reviewing the directory, caller ID log or redial list.
- While entering numbers or names in the directory, press to move the cursor to the left.

### MENU/SELECT

- Press to show the menu (page 10).
- While in a menu, press to choose an item, or save an entry or setting.

### OFF/CANCEL

- During a call, press to hang up.
- While the handset is ringing, press to silence the ringer temporarily (page 20).
- Press and hold to erase the missed call indicator when the phone is not in use (page 36).
- While in a menu, press to return to the previous menu, or press and hold to return to idle mode, without making changes.

### MUTE/DELETE

- While on a call, press to mute the microphone (page 20).
- While using the dialing keys, press to delete digits or characters (page 19 and page 29).
- While the handset is ringing, press to silence the ringer temporarily (page 20).
- When reviewing the directory, caller ID log or redial list, press to delete the displayed entry (page 32, page 40 or page 21).

### QUIET#

- Press and hold to set and turn on the quiet mode, or turn it off (page 12).
- Press repeatedly to show other dialing options when reviewing a caller ID log entry (page 38).

### INT

- Press to start an intercom conversation or transfer a call (for multi-handset models only) (page 26).

# Telephone settings

## Using the menu

You can use a cordless handset to change the telephone settings.

In the ringers menu, you can select the ringer tones and adjust the ringer volume for incoming calls.

In the settings menu, you can change the settings for LCD language, voicemail number, voicemail indicators, key tone, home area code and dial mode.

Go to **Answering system settings** (from page 41 to page 46) for instructions to change the answering system settings.

### To enter the handset menu:

1. Press **MENU** when the phone is not in use.
  2. Press ▼ or ▲ until the handset displays the desired feature menu.
  3. Press **SELECT** to enter that menu.
- To return to the previous menu, press **CANCEL**.
  - To return to idle mode, press and hold **CANCEL**.

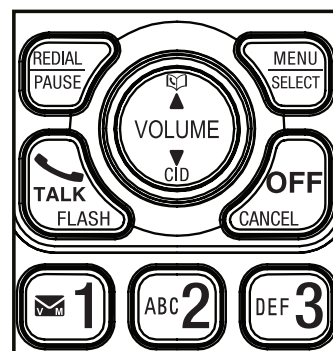

## Handset ringer volume

You can adjust the ringer volume or turn the ringer off on each handset. When the ringer is turned off, the handset displays  and **Ringer off**.

1. Press **MENU** when the handset is not in use.
2. Press ▼ or ▲ until the handset displays **◆Ringers**, then press **SELECT**.
3. The handset displays **◆Ringer volume**, then press **SELECT** again.
4. Press ▼ or ▲ to sample each ringer volume level.
5. Press **SELECT** to save your selection. You hear a confirmation tone.



### note

The ringer volume also determines the ringer volume for intercom calls. If the ringer volume is set to off, that handset is silenced for all incoming calls except paging tone.

# Telephone settings

## Telephone base ringer volume

Press **VOL+** or **VOL-** on the telephone base to adjust the ringer volume when the phone is not in use.

When you set the ringer volume to zero, the base ringer is off and the telephone base announces, “*Base ringer is off.*”

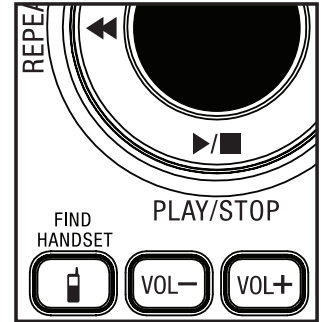

## Ringer tone

You can choose from different ringer tones on each handset.

1. Press **MENU** when the handset is not in use.
2. Press ▼ or ▲ until the handset displays ♦**Ringers**, then press **SELECT**.
3. Press ▼ or ▲ until the handset displays ♦**Ringer tone**, then press **SELECT**.
4. The handset displays ♦**Tone:** with the current setting displayed. Press ▼ or ▲ to sample each ringer tone.
5. Press **SELECT** to save your selection. You hear a confirmation tone.

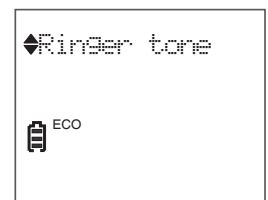

**note**

If you turn off the ringer volume, you will not hear ringer tone samples.



# Telephone settings

## Quiet mode

You can turn on the quiet mode for a period of time (1-12 hours). During this period, all tones (except paging tone) and call screening are muted.

When you turn on the quiet mode, the answering system turns on automatically. When the quiet mode duration expires, the answering system remains on.

### To set the duration and turn on the quiet mode:

1. Press and hold QUIET# when the handset is not in use.
2. The handset displays **Quiet: \_\_ hours**. Use the dialing keys (0-9) to enter the desired duration (1-12).
3. Press **SELECT** to save. You hear a confirmation tone.  
The handset displays **Quiet mode on, ANS ON** and .  
The  light on the telephone base turns on.

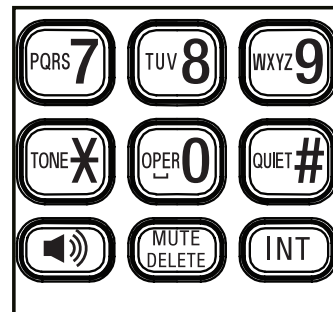

### To turn off the quiet mode:

- Press and hold QUIET# when the handset is not in use. The handset displays **Quiet mode off** briefly and then returns to idle.

#### note

When you change the settings of the ringer tone, handset ringer volume or telephone base ringer volume, you can still hear the samples even if the quiet mode is on.

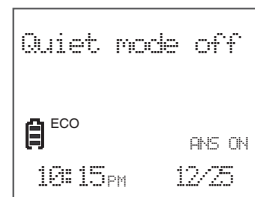
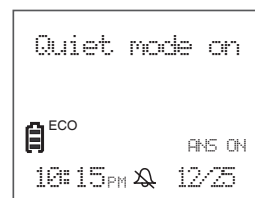



# Telephone settings

## Set date and time

The answering system announces the date and time of each message prior to playing it. Before using the answering system, set the date and time as follows. If you subscribe to caller ID service, the day, month and time are set automatically with each incoming call. However, the year must be correct so that the day of the week can be calculated from the caller ID information.

1. Press **MENU** when the handset is not in use.
2. Press ▼ or ▲ until the handset displays **◆Set date/time**, then press **SELECT**.
3. Press ▼ or ▲ to select the month then press **SELECT**, or use the dialing keys to enter a two-digit number (**01-12**).
4. Press ▼ or ▲ to select the date then press **SELECT**, or use the dialing keys to enter a two-digit number (**01-31**).
5. Press ▼ or ▲ to select the year then press **SELECT**, or use the dialing keys to enter a two-digit number (**00-99**) then press **SELECT**.
6. Press ▼ or ▲ to select the hour then press **SELECT**, or use the dialing keys to enter a two-digit number (**01-12**).
7. Press ▼ or ▲ to select the minute then press **SELECT**, or use the dialing keys to enter a two-digit number (**00-59**).
8. Press ▼ or ▲ to select **AM** or **PM**.
9. Press **SELECT** to save the settings. You hear a confirmation tone.



### note

- If the date and time are not set when a message is recorded, the system announces, "Time and date not set," before each message plays.
- The phone plays two beeps if you enter an invalid number.

# Telephone settings

## LCD language

You can select English, French or Spanish to be used in all screen displays.

1. Press **MENU** when the handset is not in use.
2. Press **▼** or **▲** until the handset displays **◆Settings**, then press **SELECT**.
3. Press **SELECT** to choose **◆LCD language**.
4. Press **▼** or **▲** to choose **◆English**, **◆Français** or **◆Español**, then press **SELECT**.
  - The screen displays **Set English?** when you choose **English**.
  - The screen displays **Set Francais?** when you choose **Français**.
  - The screen displays **Set Espanol?** when you choose **Español**.
5. Press **SELECT** to save your selection. You hear a confirmation tone.





**note**

If you accidentally change the LCD language to French or Spanish, you can reset it to English easily by pressing **MENU** then entering **\*364#**.

# Telephone settings

## Voice mail number

If you subscribe to voicemail service offered by your telephone service provider, you can save the voicemail number to  **1** on each handset for easy access. When you want to retrieve voicemail messages, press and hold  **1**. Contact your telephone service provider for more information and assistance about using your voicemail service.

### To set your voicemail number:

1. Press and hold  **1** when the phone is not in use.
2. Use the dialing keys to enter the voicemail number (up to 30 digits).
  - Press **▼** or **▲** to move the cursor to the left or right.
  - Press **DELETE** to erase a digit.
  - Press and hold **DELETE** to erase all digits.
  - Press and hold **PAUSE** to insert a dialing pause (a **P** appears).
3. Press **SELECT** to save. Then the handset dials the saved voicemail number.

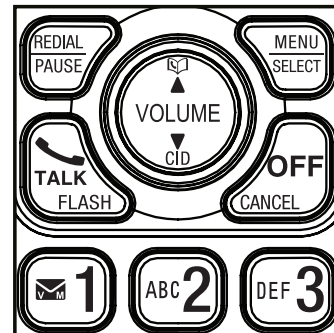

**-OR-**

1. Press **MENU** when the handset is not in use.
2. Press **▼** or **▲** to scroll to **◆Settings**, then press **SELECT**.
3. Press **▼** or **▲** to scroll to **◆Voicemail #**, then press **SELECT**.
4. Use the dialing keys to enter the voicemail number (up to 30 digits).
  - Press **▼** or **▲** to move the cursor to the left or right.
  - Press **DELETE** to erase a digit.
  - Press and hold **DELETE** to erase all digits.
  - Press and hold **PAUSE** to insert a dialing pause (a **P** appears).
5. Press **SELECT** to save. The handset displays **VM # saved** and the stored number. You hear a confirmation tone.

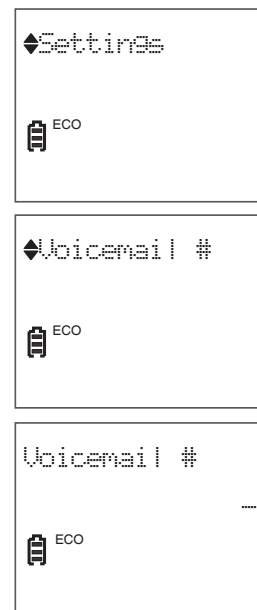

# Telephone settings

## Clear voicemail

If you subscribe to voicemail service offered by your telephone service provider, the handsets display **New voicemail** and  when you have new voicemail messages. Contact your telephone service provider for more information about using your voicemail service.

After you have listened to all new voicemail messages, the indicators on the handsets turn off automatically.

Use the clear voicemail feature when the telephone indicates that there is new voicemail but there are none (for example, when you have accessed your voicemail while away from home). The clear voicemail feature only turns off the indicators; it does not delete your voicemail messages. As long as you have new voicemail messages, your telephone service provider continues to send the signal to turn on the indicators.

### To manually turn off these indicators:

1. Press **MENU** when the handset is not in use.
2. Press **▼** or **▲** until the handset displays **◆Settings**, then press **SELECT**.
3. Press **▼** or **▲** until the handset displays **◆Clr voicemail**, then press **SELECT**. The handset displays **Reset VM Icon?**
4. Press **SELECT** to save your selection. You hear a confirmation tone.



#### note

Your telephone service provider may alert you of new messages with a stutter (broken) dial tone. Contact your telephone service provider for details.

# Telephone settings

## Key tone

You can turn the key tone on or off for each handset.

If you turn the key tone on, the handset beeps with each key press. If you turn the key tone off, there are no beeps when you press the handset keys.

1. Press **MENU** when the handset is not in use.
2. Press ▼ or ▲ until the handset displays **◆Settings**, then press **SELECT**.
3. Press ▼ or ▲ until the handset displays **◆Key tone**, then press **SELECT**.
4. Press ▼ or ▲ to choose **◆Key tone:On** or **◆Key tone:Off**.
5. Press **SELECT** to save your selection. You hear a confirmation tone.



## Home area code

If you dial local calls using only seven digits (area code not required), you can program your home area code so that when you receive a call within your local area, the telephone number is automatically stored in the caller ID log without the area code.

1. Press **MENU** when the phone is not in use.
2. Press ▼ or ▲ until the handset displays **◆Settings**, then press **SELECT**.
3. Press ▼ or ▲ until the handset displays **◆Home area code**, then press **SELECT**.
4. Use the dialing keys (**0-9**) to enter the desired home area code.
  - Press **DELETE** to delete a digit.
  - Press and hold **DELETE** to delete all digits.
5. Press **SELECT** to save. You hear a confirmation tone.

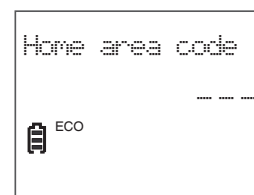

### note

If, in the future, your telephone service provider requires you to dial the area code when making a local call, or, if you move to a location that requires it, follow the steps above to delete the home area code you have already programmed. After you have deleted the home area code, \_\_\_ appears.

# Telephone settings

## Dial mode



The dial mode is preset to touch-tone dialing. If you have pulse (rotary) service, you must change the dial mode to pulse dialing before using the telephone to make a call.

1. Press **MENU** when the phone is not in use.
2. Press ▼ or ▲ until the handset displays ♦Settings, then press **SELECT**.
3. Press ▼ or ▲ until the handset displays ♦Dial mode, then press **SELECT**.
4. Press ▼ or ▲ to choose ♦Touch-tone or ♦Pulse.
5. Press **SELECT** to save your selection. You hear a confirmation tone.



# Telephone operation

## Make a call



1. Press  or  on the handset.
2. When you hear a dial tone, dial the number with the dialing keys (**0-9**).

### note

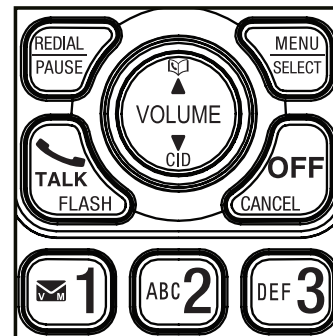
- The screen displays the elapsed time as you talk (in hours, minutes and seconds).
- While entering numbers, press and hold PAUSE to insert a dialing pause (a **P** appears).



## Predial a call

1. Enter the number with the dialing keys (**0-9**).
2. Press  or  to dial.

### note

- The screen displays the elapsed time as you talk (in hours, minutes and seconds).
- While predialing, press **DELETE** or **CANCEL** to backspace and delete; press and hold PAUSE to insert a dialing pause (a **P** appears).

## Answer a call

- Press ,  or any dialing key (**0-9**, **TONE\*** or **QUIET#**).

## End a call

- Press **OFF** or put the handset to the telephone base or charger.

## Speakerphone

During a call, press  to switch between speakerphone and normal handset use.

When the speakerphone is active, the handset displays **Speaker**.

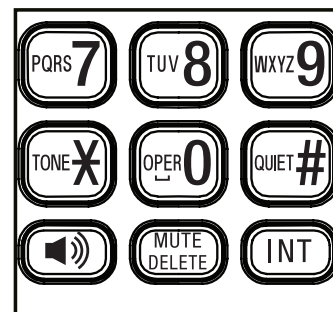

# Telephone operation

## Volume

During a call, press ▲/VOLUME or ▼/VOLUME to adjust the listening volume.

When the volume reaches the minimum or maximum setting, you hear two beeps.

**note** The handset earpiece and speakerphone volume settings are independent.

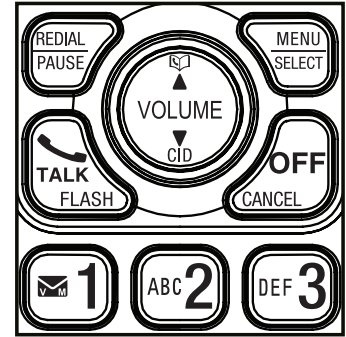

## Mute

The mute function allows you to hear the other party but the other party cannot hear you.

- During a call, press **MUTE**. The handset displays **Muted** until the mute function is turned off.
- Press **MUTE** again to resume the conversation. The handset displays **Microphone on** briefly.



## Call waiting

When you subscribe to call waiting service from your telephone service provider, you hear an alert tone if there is an incoming call while you are already on another call.

- Press **FLASH** to put the current call on hold and take the new call.
- Press **FLASH** at any time to switch back and forth between calls.

## Temporary ringer silencing

When the telephone is ringing, you can temporarily silence the ringer of the handset or telephone base without disconnecting the call. The next call rings normally at the preset volume.

### To silence the handset ringer:

- Press **OFF** or **MUTE**, then  displays and **Ringer muted** displays briefly.



### To silence the telephone base ringer:

- Press **VOL-**.

**note** Each handset and the base ring when there is an incoming call unless the ringer volume of that device is turned off.



# Telephone operation

## Temporary tone dialing

If you have pulse (rotary) service only, you can switch from pulse to touch-tone dialing temporarily during a call. This is useful if you need to send touch-tone signals to access your telephone banking or long distance services.

1. During a call, press **TONE~~X~~**.
2. Use the dialing keys to enter the number. The telephone sends touch-tone signals. It automatically returns to pulse dialing mode after you end the call.

## Redial

Each handset stores the last 10 telephone numbers dialed.

- When there are already 10 entries, the oldest entry is deleted to make room for the new entry.
- Entries are in reverse chronological order.
- The handset plays two beeps when you reach the end or beginning of the redial list, or when you access the redial list with no records.

### To review and dial a redial entry:

1. Press **REDIAL** when the phone is not in use.
2. Press **▼**, **▲** or **REDIAL** repeatedly until the desired entry displays.
3. Press **TALK** or **ECO** to dial.

**-OR-**

1. Press **TALK** or **ECO** when the phone is not in use.
2. Press **REDIAL** and then press **▼**, **▲** or **REDIAL** repeatedly until the desired entry displays.
3. Press **SELECT** to dial.

### To delete a redial entry:

1. Press **REDIAL** when the handset is not in use.
2. Press **▼**, **▲** or **REDIAL** repeatedly to browse to the desired entry.
3. Press **DELETE** to delete the displayed number. You hear a confirmation tone.

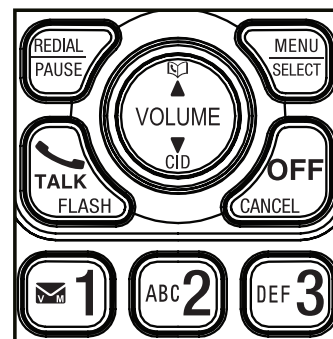

# Telephone operation

## Check voicemail

Press and hold  **1** to dial your voicemail number.

**note** See **Voicemail number** on page 15.

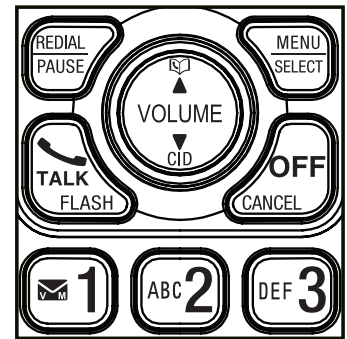

## Chain dialing

Use this feature to initiate a dialing sequence from numbers stored in the directory, caller ID log or redial list while you are on a call. Chain dialing can be useful if you wish to access other numbers (such as bank account numbers or access codes) from the directory, caller ID log or redial list.

### To access a number in the directory:

1. Press **MENU** while on a call.
2. Press **SELECT** to choose **◆Directory**.
3. Press **▼** or **▲** to scroll to the desired entry.
4. Press **SELECT** to dial the displayed number.

### To access a number in the caller ID log:

1. Press **MENU** while on a call.
2. Press **▼** or **▲** to scroll to **◆Caller ID log**, then press **SELECT**.
3. Press **▼** or **▲** to scroll to the desired entry.
4. Press **SELECT** to dial the displayed number.

### To access a number on the redial list:

1. Press **REDIAL** while on a call.
2. Press **▼**, **▲** or **REDIAL** repeatedly to browse to the desired entry.
3. Press **SELECT** to dial the displayed number.

**note** Press **CANCEL** to exit the directory, caller ID log or redial list when you are on a call.

# Telephone operation

## Web address

Use this feature to view the VTech website address.

1. Press **MENU** when the handset is not in use.
2. Press **▼** or **▲** until the handset displays **◆Web address**, then press **SELECT**. The handset displays the VTech website address.

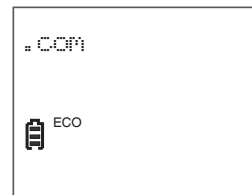



## Transfer a call

While on an outside call, you can transfer the call from one handset to another.

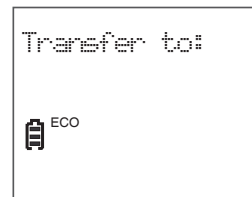
1. During a call, press **MENU**.
2. Press **▼** or **▲** to scroll to **◆Transfer**, then press **SELECT**.
  - If you have two handsets, your handset displays **Calling HS X** and then **Transferred**.
  - If you have three or more handsets, your handset displays **Transfer to:** Use the dialing keys to select a destination handset. Your handset displays **Calling HS X** and then **Transferred**.



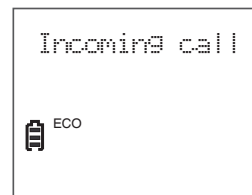

The destination handset rings and its screen displays **Incoming call**.

3. To answer on the destination handset, press  **TALK**, , or any dialing key (**0-9**, **TONEX** or **QUIET#**) on the destination handset.



### note

- If the destination handset does not answer the call within 30 seconds, the call will be reverted to the originating handset. If you do not press , **TALK**, , or any dialing key (**0-9**, **TONEX** or **QUIET#**) on your handset to reconnect the outside call within 30 seconds, the call ends automatically.
- If the destination handset is in the directory or caller ID log, or is out of range, the originating handset displays **Unable to call** and then reconnects to the outside call.

# Telephone operation

## Find handset

Use this feature to find all system handsets.



### To start paging:

- Press /FIND HANDSET on the telephone base when not in use. All idle handsets ring and display **\*\* Paging \*\***.

### To end paging:

- Press /FIND HANDSET on the telephone base.

-OR-

- Press , , **OFF** or any dialing key (**0-9**, **TONEX** or **QUIET#**) on a handset.

-OR-

- Place the handset in the telephone base or charger.

- note** • Do not press and hold /FIND HANDSET for more than 4 seconds. It may lead to handset deregistration.
- Press **MUTE** to turn off the ringer of a handset temporarily. Paging tone continues on all other handsets.

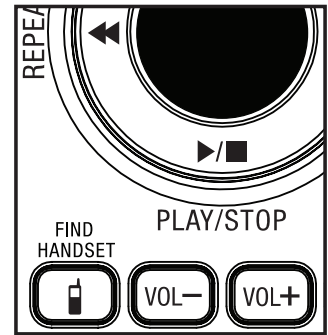

# Multiple handset use



## Join a call in progress

You can use up to two handsets at the same time on an outside call.

You can buy additional expansion handsets (**CS6609**) for this telephone base.

You can register up to five handsets to the telephone base.

## To share an outside call:

- When a handset is already on a call and you would like to join the call, press  or  on the other handset.
- To exit the call, press **OFF** or place the handset in the telephone base or charger. The call continues until both handsets hang up.

# Multiple handset use

## Intercom

Use the intercom feature for conversations between two handsets. You can buy additional expansion handsets (**CS6609**) for this telephone base. You can register up to five handsets to the telephone base.

1. Press **INT** on your handset when not in use.

- If you have only one handset, your handset displays **INT needs 2 HS**.
- If you have two handsets, your handset displays **Calling HS X**.
- If you have three or more handsets, your handset displays **Intercom to**. Use the dialing keys to enter a destination handset. Your handset displays **Calling HS X**.

The destination handset rings and its screen displays **HS X is calling**.



2. To answer the intercom call, press **TALK**, **INT** or any dialing key (**0-9**, **TONEX** or **QUIET#**) on the destination handset. Both handsets now display **Intercom**.

3. To end the intercom call, press **OFF** or place the handset back in the telephone base or charger. Both handsets now display **Intercom ended**.

### note

- You can cancel the intercom call before it is answered by pressing **OFF** or **INT** on the originating handset.
- If the destination handset does not answer the intercom call within 100 seconds, is accessing the answering system, is on a call or out of range, the originating handset displays **Unable to call** and returns to idle mode.
- Press **OFF** or **MUTE** on the destination handset to temporarily silence the intercom ringer.
- You can use four handsets on two pairs of intercom calls. For example, when four handsets are used on two pairs of intercom calls, use the fifth handset for an outside call.
- If there is an incoming call while the originating handset displays **Calling HS X**, the intercom request will be stopped and the screen displays **Incoming call**.

## Answer an incoming call during an intercom call

When you receive an outside call during an intercom call, there is an alert tone.

- To answer the outside call, press **TALK**. The intercom call ends automatically.
- To end the intercom call without answering the outside call, press **OFF**. The telephone continues to ring.

# Multiple handset use

## Call transfer using intercom

Use the intercom feature to transfer an outside call to another system handset.

1. During a call, press **INT**.

- If you have two handsets, the outside call is put on hold and your handset displays **Calling HS X**.
- If you have three or more handsets, your handset displays **Intercom to**. Use the dialing keys to enter a handset number. The outside call is put on hold and your handset displays **Calling HS X**.

The destination handset rings and its screen displays **HS X is calling**.

2. To answer the intercom call on the destination handset, press , **INT** or any dialing key (**0-9**, **TONEX** or **QUIET#**). The outside call is still on hold and both handsets now display **Intercom**. You can now have a private conversation with the destination handset.

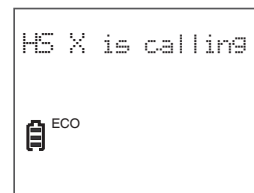

### note

- To cancel the intercom call before it is answered, press **OFF**, , or **INT** on your handset.
- If the destination handset does not answer within 100 seconds, is in use, on a call or is out of range, the originating handset displays **Unable to call** and then reconnects to the outside call.

3. From this intercom call, you have the following options:

- You can let the destination handset join you on the outside call in a three-way conversation. Press and hold **INT** on the originating handset.
- You can transfer the call. Press **OFF**, or place your handset back in the telephone base or charger. Your handset displays **Transferred**. The destination handset is then connected to the outside call.
- You can press **INT** to switch between the outside call (**Outside call** displays) and the intercom call (**Intercom** displays).
- The destination handset can end the intercom call by pressing **OFF**, or by placing the handset back in the telephone base or charger. The outside call continues with the original system handset.

# Directory

## About the directory

The directory can store up to 50 entries which are shared by all system handsets. Each entry may consist of a phone number up to 30 digits and a name up to 15 characters.

- Directory entries are shared by all system handsets. Any modifications made on one handset apply to all system handsets.
- When you access the directory without records, the screen displays **Directory empty**.
- When the directory is full and you try to save an entry, the screen displays **Directory full**.
- When you try to save an entry already stored in the directory, the screen displays **Number repeated**.
- When the telephone number in the directory exceeds 15 digits, a dash appears after the 14th digit, and the remaining digits are displayed after two seconds beginning with a dash.
- Only one handset can review the directory at a time. When a handset tries to enter the directory while another handset is already in it, **Not available** appears.

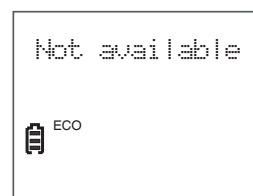



# Directory

## Add a directory entry

1. Press **MENU** when the phone is not in use.
2. Press **▼** or **▲** to scroll to **◆Directory**, then press **SELECT**.
3. Press **SELECT** to choose **◆Add contact**.
4. When **Enter number** displays, use the dialing keys to enter a number (up to 30 digits).
  - Press **▼** or **▲** to move the cursor to the left or right.
  - Press **DELETE** to backspace and erase a digit.
  - Press and hold **DELETE** to erase all digits.
  - Press and hold **PAUSE** to enter a dialing pause (a **P** appears).

**-OR-**

Copy a number from the redial list by pressing **REDIAL**. Then press **▼**, **▲** or **REDIAL** repeatedly to find the desired number. Press **SELECT** to copy the number.

5. Press **SELECT** to move on to the name.
6. When **Enter name** displays, use the dialing keys to enter a name (up to 15 characters). Each time you press a key, the character on that key appears. Additional key presses produce other characters on that key. Press the key repeatedly until the desired character appears. The first character of each word is capitalized.
  - Press **▼** or **▲** to move the cursor to the left or right.
  - Press **0** to add a space.
  - Press **DELETE** to backspace and erase a character.
  - Press and hold **DELETE** to erase all characters.
7. Press **SELECT** to confirm. The screen displays **Saved** and then you hear a confirmation tone.

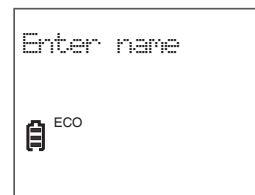
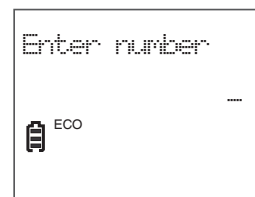

# Directory

## Add a directory entry

-OR-

1. Use the dialing keys to enter a number (up to 30 digits) when the phone is not in use. Press **SELECT**. The handset displays **Enter number**.

- Press ▼ or ▲ to move the cursor to the left or right.
- Press **DELETE** to backspace and erase a digit.
- Press and hold DELETE to erase all digits.
- Press and hold PAUSE to enter a dialing pause (a **P** appears).

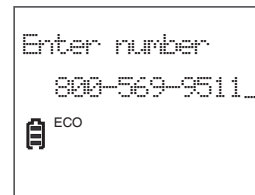

-OR-

Copy a number from the redial list by pressing **REDIAL**. Then press ▼, ▲ or **REDIAL** repeatedly to find the desired number. Press **SELECT** to copy the number.

2. Press **SELECT** to move on to the name.

3. When **Enter name** displays, use the dialing keys to enter a name (up to 15 characters). Each time you press a key, the character on that key appears. Additional key presses produce other characters on that key. Press the key repeatedly until the desired character appears. The first character of each word is capitalized.





- Press ▼ or ▲ to move the cursor to the left or right.
- Press **0** to add a space.
- Press **DELETE** to backspace and erase a character.
- Press and hold DELETE to erase all characters.

4. Press **SELECT** to confirm. The screen displays **Saved** and then you hear a confirmation tone.









# Directory

## Review and dial from the directory

Entries are sorted alphabetically.

1. Press  when the phone is not in use. The screen displays **Entries in DIR X** and then the first entry in the directory.
2. Press  or  to browse. When the desired entry displays, press  or  to dial.

**-OR-**

1. Press **MENU** when the phone is not in use.
2. Press  or  to scroll to **◆Directory** then press **SELECT**.
3. Press  or  to scroll to **◆Review** and then press **SELECT**. The screen displays **Entries in DIR X** and then the first entry in the directory.
4. Press  or  to browse. When the desired entry displays, press  or  to dial.









## Alphabetical search

### To start an alphabetical search:

1. Press  when the phone is not in use. The screen displays **Entries in DIR X** and then the first entry in the directory.

**-OR-**

- i. Press **MENU** when the phone is not in use.
  - ii. Press  or  to scroll to **◆Directory**, then press **SELECT**.
  - iii. Press  or  to scroll to **◆Review**, then press **SELECT**. The screen displays **Entries in DIR X** and then the first entry in the directory.
2. Use the dialing keys to enter the letter associated with the name. For example, if you have entries for Jenny, Jessie, Kristen and Laura in your directory, press **5** (JKL) once to see Jenny (when **Jenny** displays, press  to see **Jessie**), twice to see Kristen, or three times to see Laura. If there is no name entry matching your search, the next closest match in alphabetical order appears. If necessary, press  or  to browse.

# Directory

## Edit a directory entry

1. Search for the desired entry in the directory (see **Review and dial from the directory** or **Alphabetical search** on page 31).
2. When the desired entry appears, press **SELECT**. The screen displays **Edit number** and the stored number.
3. Use the dialing keys to edit the number.
  - Press **DELETE** to backspace and erase a digit.
  - Press and hold **DELETE** to erase the entire entry.
  - Press **▼** or **▲** to move the cursor to the left or right.
  - Press and hold **PAUSE** to insert a dialing pause (a **P** appears).
4. Press **SELECT** to move on to edit the name. The screen displays **Edit name** and then the stored name.
5. Use the dialing keys to edit the name (up to 15 characters). Additional key presses show other characters of that particular key.
  - Press **DELETE** to backspace and erase a character.
  - Press and hold **DELETE** to erase the entire entry.
  - Press **▼** or **▲** to move the cursor to the left or right.
  - Press **0** to add a space.
6. Press **SELECT** to confirm. The screen displays **Saved** and then you hear a confirmation tone.

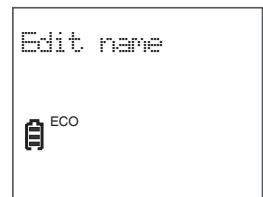

## Delete a directory entry

1. Search for the desired entry in the directory (see **Review and dial from the directory** or **Alphabetical search** on page 31).
2. When the desired entry appears, press **DELETE**. The screen displays **Delete contact?** and the number.
3. Press **SELECT** to confirm. The screen displays **Deleting ...** and then **Contact deleted**. You hear a confirmation tone.

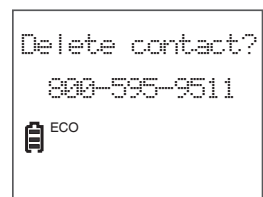

# Directory

## Speed dial

You can copy up to 9 directory entries into the speed dial locations (**0** and **2-9**) so that you can dial these numbers using fewer keys than usual.

The speed dial memory locations are stored in the telephone base and are shared by all handsets. Changes made to the speed dial entries on one handset apply to all.

## Assign a speed dial entry

1. Press **MENU** when the phone is not in use.
2. Press **▼** or **▲** to scroll to **◆Directory**, then press **SELECT**.
3. Press **▼** or **▲** to scroll to **◆Speed dial**, then press **SELECT**.
4. Press **▼** or **▲** or the dialing keys (**0** or **2-9**) to choose the desired speed dial location.
5. Press **SELECT**. The screen displays **Copy from DIR...** and then the first entry in the directory.
6. Press **▼** or **▲** to browse to the desired entry.

**-OR-**

Use the alphabetical search to find the desired entry (see page 31).

7. Press **SELECT** to save. You hear a confirmation. The name (up to 12 characters) appears in the selected speed dial location.

**note**

- If the directory is empty, when you press **SELECT** in Step 5, the screen displays **Directory empty**.
- If the speed dial location you selected is occupied, the new directory entry you selected replaces the old one. Take caution not to replace entries you do not wish to delete from the speed dial locations.



# Directory

## Reassign a speed dial entry

1. Press **MENU** when the phone is not in use.
2. Press ▼ or ▲ to scroll to ◆**Directory**, then press **SELECT**.
3. Press ▼ or ▲ to scroll to ◆**Speed dial**, then press **SELECT**.
4. Press ▼ or ▲, or use the dialing keys to choose the speed dial location you want to reassign.
5. Press **SELECT** twice. The screen displays ◆**Reassign SD**.
6. Press **SELECT**. The screen displays **Copy from DIR...** and then the first entry of the directory.
7. Press ▼ or ▲ to browse to the desired entry.  
**-OR-**  
Use the alphabetical search to find the desired entry (see page 31).
8. Press **SELECT** to save. You hear a confirmation. The name (up to 12 characters) appears in the selected speed dial location.



## Dial a speed dial number

- Press and hold a dialing key (**0** or **2-9**) to dial the number stored in the corresponding speed dial location.

**note**

When the speed dial location is empty, the screen displays the speed dial list. See **Assign a speed dial entry** on page 33 to add a new entry.

## Delete a speed dial entry

1. Press **MENU** when the phone is not in use.
2. Press ▼ or ▲ to scroll to ◆**Directory**, then press **SELECT**.
3. Press ▼ or ▲ to scroll to ◆**Speed dial**, then press **SELECT**.
4. Press ▼ or ▲, or use the dialing keys to choose the desired speed dial location, then press **DELETE**. The screen displays **Clear SD #X?**
5. Press **SELECT** to confirm. You hear a confirmation tone.

**note**

Deleting the speed dial entries does not affect the entries in the directory.



# Caller ID

## About caller ID

This product supports caller ID services provided by most telephone service providers. Depending on your service subscription, you may see the caller's number, or the caller's name and number that are sent by your telephone service provider after the first or second ring. Caller ID allows you to see the name, number, date and time of calls.

## Information about caller ID with call waiting

Caller ID with call waiting lets you see the name and telephone number of the caller before answering the telephone, even while on another call.

It may be necessary to change your telephone service to use this feature. Contact your telephone service provider if:

- You have both caller ID and call waiting, but as separate services (you may need to combine these services).
- You have only caller ID service, or only call waiting service.
- You do not subscribe to caller ID or call waiting services.

There are fees for caller ID services. In addition, services may not be available in all areas.

This product can provide information only if both you and the caller are in areas offering caller ID service and if both telephone service providers use compatible equipment. The time and date, along with the call information, are from the telephone service provider.

You can use this product with regular caller ID service, or you can use this product's other features without subscribing to caller ID or combined caller ID with call waiting service.

# Caller ID

## Caller ID log

If you subscribe to caller ID service, information about each caller will appear after the first or second ring. If you answer a call before the caller information appears on the screen, it will not be saved in the caller ID log.

- The caller ID log stores up to 50 entries. Each entry has up to 24 digits for the phone number and 15 characters for the name. If the telephone number has more than 15 digits, only the last 15 digits appear. If the name has more than 15 characters, only the first 15 characters are shown and saved in the caller ID log.
- You can review, redial and copy an entry into the directory.
- Entries appear in reverse chronological order.
- When the caller ID log is full, the oldest entry is deleted to make room for new incoming call information.
- **XX missed calls** displays when you have incoming calls that have not been answered.
- **Call log empty** displays when you access the caller ID log without records.
- Caller ID log entries are shared by all system handsets. Any deletions made on one handset are reflected on all other handsets.
- Only one handset can review the caller ID log at a time. If a handset tries to enter the caller ID log while another handset is already in it, **Not available** displays.

### note

- For caller ID log entries with numbers between 16 and 24 digits, in order to view the entire number, you must save the entry to the directory (see page 39).
- If the phone number has more than 24 digits, it will not be saved or shown in the caller ID log.

## Missed call indicator

When you have incoming calls that have not been answered, the handset displays **XX missed calls**.

Each time you review a caller ID log entry marked **NEW**, the number of missed calls decreases by one.

When you have reviewed all the missed calls, the missed call indicator no longer displays.

If you do not want to review the missed calls one by one, press and hold **CANCEL** on the idle handset to erase the missed call indicator. All the entries are then considered old and kept in the caller ID log.





# Caller ID

## Memory match

When the incoming telephone number matches the last seven digits of a telephone number in your directory, the name that appears on the screen matches the corresponding name in your directory.

For example, if Linda Jones calls, her name appears as **Linda** if this is how you entered it into your directory.

**note**

The number shown in the caller ID log is in the format sent by the telephone service provider. The telephone service provider usually delivers 10-digit phone numbers (area code plus telephone number). If the phone number of the caller does not match a number in your directory, the name will appear as it is delivered by the telephone service provider.

## Review and dial from the caller ID log

1. Press **CID** when the phone is not in use. The handset displays **Entries in CID X** and then the first entry in the caller ID log.

2. Press ▼ or ▲ to browse.

3. When the desired entry displays, press  or  to call.

**-OR-**

1. Press **MENU** when the phone is not in use.

2. Press ▼ or ▲ to scroll to **Caller ID log** then press **SELECT**.

3. Press **SELECT** to choose **Review**.

4. Press ▼ or ▲ to browse.

5. When the desired entry displays, press  or  to call.

**note**

You hear a double beep when you reach the beginning or end of the caller ID log.

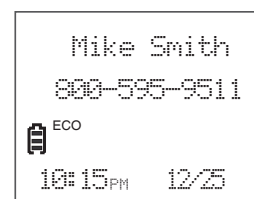



# Caller ID

## View dialing options

Although the caller ID log entries received have 10 digits (the area code plus the seven-digit number), in some areas, you may dial only the seven digits, or a 1 plus the seven digits, or a 1 plus the area code plus the seven digits. You can change the number of digits that you dial from the caller ID log and store the new number to the directory.

While reviewing the caller ID log, press **QUIET#** repeatedly to show different dialing options for local and long distance numbers before dialing or saving the telephone number in the directory.

Press **1** repeatedly if you need to add or remove 1 in front of the telephone number before dialing or saving it in the directory.

When the number is shown in the correct format for dialing, press  or  to dial.

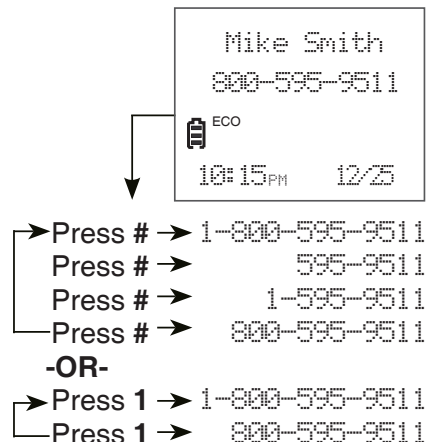

# Caller ID

## Save a caller ID log entry to the directory

1. Press **CID** when the phone is not in use.

**-OR-**

Press **MENU** when the phone is not in use. Press ▼ or ▲ to scroll to **Caller ID log**. Then press **SELECT** twice.

2. When the desired entry appears, press **SELECT**. The screen displays **Edit number** and the stored number.

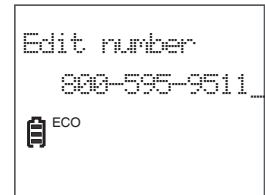

3. Use the dialing keys to edit the number.

- Press **DELETE** to backspace and erase a digit.
- Press and hold **DELETE** to erase the entire entry.
- Press ▼ or ▲ to move the cursor to the left or right.
- Press and hold **PAUSE** to insert a dialing pause (a **P** appears).

4. Press **SELECT** to move on to edit the name. The screen displays **Edit name**.



5. Use the dialing keys to enter the name (up to 15 characters). Additional key presses show other characters of that particular key.

- Press **DELETE** to backspace and erase a character.
- Press and hold **DELETE** to erase the entire entry.
- Press ▼ or ▲ to move the cursor to the left or right.
- Press **0** to add a space.

6. Press **SELECT** to confirm. The screen displays **Saved** and then you hear a confirmation tone.

### **note**

If you try to save an entry without caller ID information, the screen displays **Unable to save** and you hear a double beep.

# Caller ID

## Delete the caller ID log entries

### To delete an entry:

1. When in the caller ID log, press ▼ or ▲ to browse.
2. Press **DELETE** to delete the selected entry. The screen displays **Deleting...** and then you hear a confirmation tone.

### To delete all entries:

1. Press **MENU** when the phone is not in use.
2. Press ▼ or ▲ to scroll to **Caller ID log**, then press **SELECT**.
3. Press ▼ or ▲ to scroll to **Del all calls**, then press **SELECT**.
4. Press **SELECT** to confirm. The screen displays **Deleting...** and then you hear a confirmation tone.



## Caller ID log screen messages

Displays	When
PRIVATE NAME	The caller is blocking the name information.
PRIVATE NUMBER	The caller is blocking the telephone number information.
PRIVATE CALLER	The caller is blocking the name and number information.
UNKNOWN NAME	This caller's name is unavailable.
UNKNOWN NUMBER	This caller's number is unavailable.
UNKNOWN CALLER	No call information is available about this caller.
LONG DISTANCE -OR- L (before the caller's number)	It is a long distance call.

# Answering system settings

## Answering system

Use the answering system menu of a cordless handset to turn on or off the answering system, message alert tone or call screening, set up the announcement message, or change the number of rings, remote access code or message recording time.

You may also turn on or off the answering system at the telephone base.

## Announcement

The telephone is preset with a greeting that answers calls with *“Hello, please leave a message after the tone.”* You can use this preset announcement, or replace it with your own.

## Record your own announcement

1. Press **MENU** when the phone is not in use.
2. Press **▼** or **▲** to scroll to **◆Answering sys**, then press **SELECT**.
3. Press **SELECT** to choose **◆Announcement**. The screen displays **Play [2] Del [3] Rec [7]** and the handset announces, *“To play, press 2. To record, press 7.”*
4. Press **7**. The handset announces, *“Record after the tone. Press 5 when you are done.”* and the screen displays **Recording... Stop [5]**.
5. After the tone, speak towards the handset microphone to record your own announcement.
6. Press **5** when done. The handset plays back the recorded announcement. Press **5** or **OFF** to stop the playback at any time.

### note

- Your announcement can be up to 90 seconds in length.
- The system does not record any announcement shorter than two seconds.

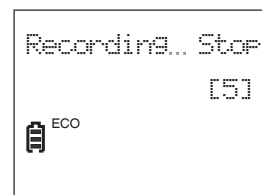

# Answering system settings

## Play the announcement

1. Press **MENU** when the phone is not in use.
2. Press **▼** or **▲** to scroll to **◆Answering sys**, then press **SELECT**.
3. Press **SELECT** to choose **◆Announcement**. The screen displays **Play [2] Del [3] Rec [7]** and the handset announces, *“To play, press 2. To record, press 7.”*
4. Press **2** to play the current announcement at the speakerphone. The screen displays **Playing... Stop [5]**.
  - Press **▼/VOLUME** to decrease or **▲/VOLUME** to increase the listening volume.
  - Press **5** or **OFF** to stop the playback at any time.
  - Press **⏻** to switch between the speakerphone and the handset earpiece.



## Delete your announcement

1. Press **MENU** when the phone is not in use.
2. Press **▼** or **▲** to scroll to **◆Answering sys**, then press **SELECT**.
3. Press **SELECT** to choose **◆Announcement**. The screen displays **Play [2] Del [3] Rec [7]** and the handset announces, *“To play, press 2. To record, press 7.”*
4. Press **3** or **DELETE** to delete your own recorded announcement. The handset announces, *“Announcement deleted.”* and the screen displays **Annc deleted**. You hear a confirmation tone.



### note

When your announcement is deleted, calls are answered with the default announcement.

# Answering system settings

## Answer on/off

The answering system must be turned on to answer and record messages.

When the answering system is turned on, the **ANS ON/OFF** light on the telephone base turns on and **ANS ON** displays on the handset.

### To turn on or off with the telephone base:

- Press **ANS ON/OFF** to turn the built-in answering system on or off when the phone is not in use.

When the answering system is turned on, it announces, *“Calls will be answered.”* When the answering system is turned off, it announces, *“Calls will not be answered.”*

### To turn on or off with a handset:

1. Press **MENU** when the phone is not in use.
2. Press **▼** or **▲** to scroll to **◆Answering sys**, then press **SELECT**.
3. Press **▼** or **▲** to scroll to **◆Answer on/off**, then press **SELECT**.
4. Press **▼** or **▲** to choose **◆Answer: On** or **◆Answer: Off**, then press **SELECT** to confirm your selection. You hear a confirmation tone.

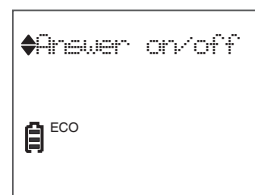
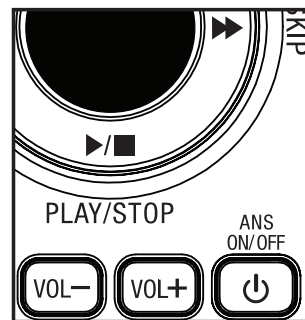

# Answering system settings

## Call screening

Use this feature to choose whether incoming messages can be heard while they are being recorded.

### To turn this feature on or off:

1. Press **MENU** when the phone is not in use.
2. Press **▼** or **▲** to scroll to **◆Answering sys**, then press **SELECT**.
3. Press **▼** or **▲** to scroll to **◆Ans sys setup**, then press **SELECT**.
4. Press **SELECT** to choose **◆Call screening**.
5. Press **▼** or **▲** to choose **◆Screening: On** or **◆Screening: Off**, then press **SELECT** to confirm your selection. You hear a confirmation tone.



## Number of rings

You can set the answering system to answer an incoming call after two, three, four, five or six rings; or toll saver. With toll saver selected, the answering system answers after two rings when you have new messages, or after four rings when you have no new messages. This enables you to check for new messages and avoid paying unnecessary long distance charges if you are calling from outside your local area.

1. Press **MENU** when the phone is not in use.
2. Press **▼** or **▲** to scroll to **◆Answering sys**, then press **SELECT**.
3. Press **▼** or **▲** to scroll to **◆Ans sys setup**, then press **SELECT**.
4. Press **▼** or **▲** to scroll to **◆# of rings**, then press **SELECT**.
5. Press **▼** or **▲** to choose **◆6**, **◆5**, **◆4**, **◆3**, **◆2** or **◆Toll saver**, then press **SELECT** to confirm your selection. You hear a confirmation tone.

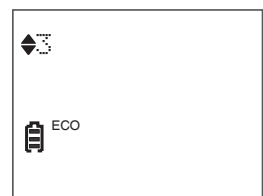
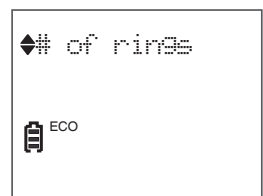
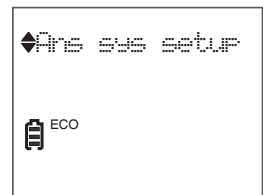



# Answering system settings

## Remote access code

A two-digit security code is required to access the answering system remotely from any touch-tone telephone. The preset code is **19**. You can set the code from **00** to **99**.

1. Press **MENU** when the phone is not in use.
2. Press ▼ or ▲ to scroll to **◆Answering sys**, then press **SELECT**.
3. Press ▼ or ▲ to scroll to **◆Ans sys setup**, then press **SELECT**.
4. Press ▼ or ▲ to scroll to **◆Remote code**, then press **SELECT**.
5. Use the dialing keys (**0-9**) to enter a two-digit number, or press ▼ or ▲ to scroll to a desired two-digit number. Then press **SELECT** to confirm your selection. You hear a confirmation tone.



## Message alert tone

When the message alert tone is set to on, and there is at least one new message, the telephone base beeps every 10 seconds.

### To turn this feature on or off:

1. Press **MENU** when the phone is not in use.
2. Press ▼ or ▲ to scroll to **◆Answering sys**, then press **SELECT**.
3. Press ▼ or ▲ to scroll to **◆Ans sys setup**, then press **SELECT**.
4. Press ▼ or ▲ to scroll to **◆Msg alert tone**, then press **SELECT**.
5. Press ▼ or ▲ to choose **◆Tone: On** or **◆Tone: Off**, then press **SELECT** to confirm your selection. You hear a confirmation tone.

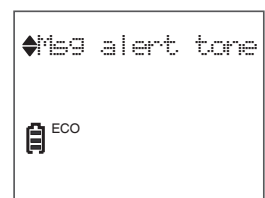
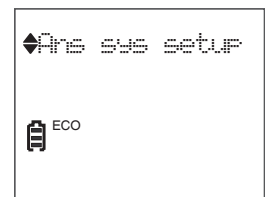

### note

- The answering system must be turned on for the message alert tone to be functional.
- Press any key on the telephone base (except **■/FIND HANDSET**) to temporarily silence the message alert tone.

# Answering system settings

## Recording time

You can set the recording time limit for each incoming message.



1. Press **MENU** when the phone is not in use.
2. Press ▼ or ▲ to scroll to **◆Answering sys**, then press **SELECT**.
3. Press ▼ or ▲ to scroll to **◆Ans sys setup**, then press **SELECT**.
4. Press ▼ or ▲ to scroll to **◆Recording time**, then press **SELECT**.
5. Press ▼ or ▲ to choose **◆3 minutes**, **◆2 minutes** or **◆1 minute**, then press **SELECT** to confirm your selection. You hear a confirmation tone.



# Answering system operation

## Answering system and voicemail

Your telephone has separate indicators for two different types of voice messages: those left on its built-in answering system and those left at your service provider's voicemail. Your telephone's built-in answering system messages and voicemail messages are separate. Each alerts you to new messages differently.

- If **XX new messages** displays on the handsets and the message window on the telephone base flashes, there are new messages recorded on the built-in answering system. To listen to the messages recorded, press **MENU** twice on a handset (page 50), or press **▶/■/PLAY** on the telephone base (page 50).
- If **New voicemail** and  display on the handsets, your telephone service provider is indicating that it has new voicemail for you. To listen to your voicemail, press and hold  1 on your handset. See **Voicemail number** on page 15 to set your voicemail number.

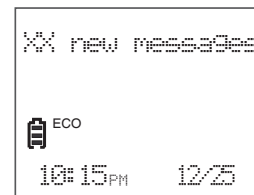

Some service providers bundle or combine multiple services like voicemail and call waiting, so you may not be aware that you have voicemail. To check what services you have and how to access them, contact your telephone service provider.

To use your voicemail service rather than your answering system, turn off your answering system. To use your answering system rather than your voicemail service, contact your telephone service provider to deactivate your voicemail service.

## Using the answering system and voicemail together

You can also use your telephone answering system and voicemail together by setting your built-in answering system to answer before voicemail answers as described below. To learn how to program your voicemail settings, contact your telephone service provider. Then, if you are on a call, or if the answering system is busy recording a message and you receive another call, the second caller can leave a voicemail message.

Set your answering system to answer calls at least two rings earlier than your voicemail is set to answer. For example, if your voicemail answers after six rings, set your answering system to answer after four rings. Some voicemail providers may program the delay before answering calls in seconds instead of rings. In this case, allow six seconds per ring when determining the appropriate setting.

# Answering system operation

## Message capacity

The answering system can record and store up to 99 messages. Each message can be up to three minutes in length (see page 46 to change). The total storage capacity for the announcement, messages and memos is approximately 14 minutes. The actual recording time depends on individual message characteristics. Messages remain available for replay until you delete them.

When **F** and number of messages are flashing alternately on the message window and the handsets display **Rec mem full**, then the memory is full. You cannot turn on the answering system and record new messages until some old messages have been deleted.

## New message indication

When there are new answering system messages, the handset displays **XX new messages**, and the message window on the telephone base flashes.

If the message alert tone is turned on, the telephone base beeps every 10 seconds when there are messages that have not been reviewed.

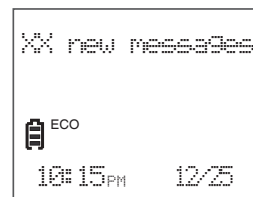

# Answering system operation

## Call screening

### To screen a call at the telephone base:

If the answering system and call screening are on (see **Call screening** on page 44), the announcement and the incoming message broadcast at the telephone base while the call is answered by the answering system.

### Options while a message is being recorded:

- Press **VOL+** or **VOL-** to adjust the call screening volume.
- Press **▶/■/STOP** to temporarily turn off the call screening.
- Press **▶/■/PLAY** or **VOL+** to temporarily turn on the call screening if it is set to off.

### To screen a call at a handset:

If the answering system is on and your answering system is recording a message, the handset displays **To screen call, press [SELECT]**. Press **SELECT** to screen the call on your handset. The handset displays the caller ID information. If you do not subscribe to caller ID service, the handset displays **Screening...**

### Options while a message is being recorded:

- Press **▲/VOLUME** or **▼/VOLUME** to adjust the call screening volume.
- Press **◀»** to switch between the handset speakerphone and the handset earpiece.

## Call intercept

If you want to talk to the person whose message is being recorded, press **TALK** or **◀»** on the handset.

# Answering system operation

## Message playback

If you have new messages, the telephone plays only the new messages (oldest first). If there are no new messages, the telephone plays back all messages (oldest first).

When playback begins, you hear the total number of messages followed by the day and time of the message. After the last message, the telephone announces, *“End of messages.”*

### To play messages at the telephone base:

Press ►/■/**PLAY** when the telephone is not in use.

### Options during playback:

- Press **VOL+** or **VOL-** to adjust the speaker volume.
- Press ►/■/**SKIP** to skip to the next message.
- Press ◀/■/**REPEAT** to repeat the playing message. Press ◀/■/**REPEAT** twice to listen to the previous message.
- Press X/■/**DELETE** to delete the playing message. The system announces, *“Message deleted,”* and then advances to the next message.
- Press ►/■/**STOP** to stop the playback.

### To play messages with a handset:

1. Press **MENU** when the telephone is not in use. The screen displays ◀/■/**Play messages**.
2. Press **SELECT**. When you have messages, the screen displays **XX New XX Old** and then **Repeat [4] Del [3] Skip [6]** and the handset announces the total number of messages. When there is no message in the answering system, the screen displays **No messages** and the handset announces, *“You have no message.”*



### Options during playback:

- Press ▼/**VOLUME** or ▲/**VOLUME** to adjust the speaker volume.
- Press ◀) to switch between the speakerphone and the handset earpiece.
- Press **6** to skip to the next message.
- Press **4** to repeat the playing message. Press **4** twice to listen to the previous message.
- Press **3** or X/■/**DELETE** to delete the playing message. The handset announces, *“Message deleted.”* The system advances to the next message.
- Press **OFF** to stop the playback.

#### note

- Only one handset or the telephone base can access the answering system at a time.
- During message playback, if there is an incoming call or another handset makes a call, message playback will be stopped.

# Answering system operation

## Delete all messages

You can only delete old (reviewed) messages. You cannot delete new messages until you review them. You cannot retrieve deleted messages.

### To delete all messages with the telephone base:

1. Press **X/DELETE** when the phone is not in use. The system announces, *"To delete all old messages, press **DELETE** again."*
2. Press **X/DELETE** immediately. The system announces, *"All old messages deleted."* If you do not have old messages, the system announces, *"You have no old message."*

### To delete all messages with a handset:

1. Press **MENU** when the phone is not in use.
2. Press ▼ or ▲ to scroll to **◆Answering sys**, then press **SELECT**.
3. Press ▼ or ▲ to scroll to **◆Delete all old**, then press **SELECT**. The screen displays **Delete all msg?** If you do not have old messages, the handset displays **No old messages**.
4. Press **SELECT** to confirm your selection. The screen displays **Deleting ...** and then **No old messages**. You hear a confirmation tone.

## Record, play or delete memos

Memos are your own recorded messages used as reminders for yourself or others using the same answering system. You can record your own memos using a system handset. Playback and delete them in the same way as incoming messages.

### To record a memo:

1. Press **MENU** when the phone is not in use.
2. Press ▼ or ▲ to scroll to **◆Answering sys**, then press **SELECT**.
3. Press ▼ or ▲ to scroll to **◆Record memo**, then press **SELECT**. The handset displays **Recording... Stop [5]** and announces, *"Record after the tone. Press 5 when you are done."*
4. Speak towards the handset microphone after the tone.
5. Press **5** or **OFF** when you finish recording. The handset announces, *"Recorded."*

#### note

- If you record a memo when the answering system memory is full, the system announces, *"Memory is full."*
- Each memo can be up to three minutes in length and memos shorter than two second are not recorded.
- When the answering system has less than three minutes of recording time left, the system announces, *"Less than three minutes to record,"* and displays **Rec mem low**.

# Answering system operation

## Message window displays

Window display	Description
0	No messages.
1-99	Total number of old messages and memos recorded. The message number currently playing.
0-99 (flashing)	Total number of new messages recorded, or the current message number during new message playback. The clock needs to be set.
1-99 & F (alternating)	The answering system memory is full with total number of messages recorded.
1-8	The telephone base speaker volume level while adjusting.
0-6	The telephone base ringer level while adjusting.
--- ---	The answering system is answering a call, or recording a memo or announcement. The handset is on a call, or in the directory or caller ID log. The answering system is being accessed remotely.



# Answering system operation

## Remote access

A two-digit security code is required to access the answering system remotely from any touch-tone telephone. The preset code is **19**. See **Remote access code** on page 45 to change it.

1. Dial your telephone number from any touch-tone telephone.
2. When the answering system answers, enter the two-digit remote access code.
3. Then you can enter one of the following remote commands.

Command	Description
1	Play all messages.
2	Play only new messages.
3	Delete the current message (during playback).
33	Delete all old messages.
4	Repeat the current message (during playback).
5	Stop.
*5	Hear a list of remote commands.
6	Skip to the next message (during playback).
*7	Record a new announcement.
8	End the call.
0	Turn the answering system on or off.

4. Hang up or press **8** to end the call.

### note

- If you do not press any key after you enter the remote access code, all new messages play. If there are no new messages, all old messages play.
- Once the new messages have played, the telephone announces the help menu options. If you do not press any key within 20 seconds, the remote access call automatically disconnects.
- When the answering system is turned off, the telephone answers after 10 rings, and announces, *"Please enter your remote access code."*
- When the memory is full, the answering system answers incoming calls after 10 rings and announces, *"Memory is full. Enter your remote access code."*

# Appendix

## Expand your telephone system

Your telephone base can support up to five handsets. Each handset must be registered to the telephone base before use. The handsets provided within your product package are already registered as **HANDSET 1** and so forth. You can add new handsets (**CS6609**, purchased separately) to your telephone base. Additional handsets are assigned numbers in the sequential order they are registered (up to **HANDSET 5**).

## Add and register a handset

When first purchased, each expansion handset displays **To register HS** and **See manual** alternately. You may need to charge the handset before registering to the telephone base. For more details on battery charging, see the table on page 4.

### To register a handset:

1. Place the new/non-registered handset in the telephone base.



Do not place the handset  
in the charger.

2. After about 10 seconds, the handset displays **Registering...** When the registration process completes, the handset displays **Registered** and you hear a confirmation tone. The registration process takes about 90 seconds to complete.

If the registration fails, the handset displays **Failed** and then **To register HS** and **See manual** alternately, remove the handset from the telephone base and place it back in. Try the registration process again.

**note**

- You cannot register a handset if any other system handset is in use.
- Only one handset can register to the telephone base at a time.



# Appendix

## Replace a handset

If you want to replace a handset, or reassign the designated handset number of a registered handset, you must deregister all handsets that are registered to the telephone base. Then register each handset individually.

To make deregistration easier, read all of the instructions below before you begin.

### To deregister all handsets:

1. Press and hold /**FIND HANDSET** on the telephone base for about 10 seconds until the **IN USE** light on the telephone base turns on and starts to flash.
2. Immediately press /**FIND HANDSET** again. You must press /**FIND HANDSET** while the **IN USE** light is still flashing. The **IN USE** light flashes for approximately five seconds.
3. All handsets display **To register HS** and **See manual** alternately when the deregistration process completes. The deregistration process takes about 10 seconds to complete.

To register the handset(s) to the telephone base again, follow the registration instructions on the previous page.

#### note

- You cannot deregister all handsets if any other system handset is in use.
- If deregistration fails, you may need to reset the system and try again. To reset, unplug the power from the telephone base and plug it back in.
- Even if the battery is depleted, you can still deregister all handsets by following the steps above. After the handset is charged for at least 10 minutes, the handset alternately shows **To register HS** and **See manual**.

# Appendix

## Screen messages

Call log empty	There are no caller ID log entries.
Calling HS X (for models with two or more handsets only)	You are calling another handset (for intercom calls).
Contact deleted	A directory entry is deleted.
Directory empty	There are no directory entries.
Directory full	The directory is full. You cannot save any new entry unless you delete some current entries.
Ended	You have just ended a call.
Failed	The handset registration is not successful.
HS X is calling (for models with two or more handsets only)	Another handset is calling (for intercom calls).
Incoming call	There is an incoming call.
INT needs 2 HS	Two handsets are required for an intercom call.
Intercom	The handset is on an intercom call.
Intercom ended	The intercom call has just ended.
Intercom to (for models with three or more handsets only)	You have started the intercom process or started transferring a call, and need to enter the desired handset number.
Line in use	A system handset or another telephone on the same line is in use.
Low battery	The battery needs to be recharged.
Message deleted	The message in the answering system is deleted.
Microphone on	MUTE is turned off and the person on the other end can hear you.
Muted	You have turned off the handset microphone. The other party cannot hear you but you can hear the other party.
New voicemail	There are new voicemail message(s) from your telephone service provider.
NO BATTERY	You place the handset in the telephone base or charger without installing a battery in it.
No line	There is no telephone line connected.
No messages	There are no message in the answering system.

# Appendix

## Screen messages

Not available	Another handset is already in the directory, caller ID log, or accessing the answering system.
Number repeated	The telephone number you have entered is already stored in the directory.
Out of range or no fur at base	The telephone base has lost power, or the handset is out of range.
Phone	The handset is on a call.
Put in charger	The battery is very low. Put the handset in the telephone base or charger for recharging.
Quiet mode on	The quiet mode is turned on.
Quiet mode off	The quiet mode is turned off.
Rec men full	The answering system has no recording time left.
Rec men low	The answering system has less than three minutes of recording time left.
Registering...	The handset registration is in progress.
Ringer muted	The handset ringer is muted temporarily during an incoming call.
Ringer off	The handset ringer is turned off.
Saved	Your selection has been saved.
Speaker	The handset speakerphone is in use.
To screen call press [SELECT]	The system is recording a message. Press <b>SELECT</b> to screen a call on a handset.
To register HS See manual	Screen display on a non-registered handset.
Transferred	You have transferred an outside call to another cordless handset.
Unable to call	The handset is out of range while on a call. Failed phone call (the telephone line is in use). Failed intercom call (there are already two handsets being used).
XX missed calls	There are new calls in the caller ID log.
XX new messages	There are new messages in the answering system.
** Paging **	All system handsets are being paged.

# Appendix

## Handset and telephone base indicators







### Handset lights

	On when the handset speakerphone is in use.
<b>CHARGE</b>	On when the handset is charging in the telephone base or charger.

### Telephone base lights

<b>IN USE</b>	On when the telephone line is in use. On when the answering system is answering a call. On when you are registering a handset. Flashes quickly when there is an incoming call. Flashes when another telephone sharing the same line is in use. Flashes when you are deregistering all handsets.
 <b>ANS ON/OFF</b>	On when the answering system is turned on.

### Handset icons

	The battery icon flashes when the battery is low and needs charging.
	The battery icon animates when the battery is charging.
	The battery icon becomes solid when the battery is fully charged.
	The speakerphone is in use.
	The handset ringer is turned off.
	There are new voicemail received from the telephone service provider.
	The message number currently playing and total number of new/old messages recorded.
<b>ANS ON</b>	The answering system is turned on.
<b>ECO</b>	The ECO mode activates automatically to reduce power consumption when the handset is within range from the telephone base.
<b>NEW</b>	The entry you are reviewing is new in the caller ID log.

# Appendix

## Battery

It takes up to 11 hours for the battery to be fully charged. When it is fully charged, you can expect the following performance:

Operation	Operating time
While in handset use (talking*)	Up to 7 hours
While in speakerphone mode (talking*)	Up to 3.5 hours
While not in use (standby**)	Up to 5 days

\* Operating times vary depending on your actual use and the age of the battery.

\*\* Handset is not charging or in use.

### The battery needs charging when:

- A new battery is installed in the handset.
- The handset beeps every 50 seconds while on a call.
- The handset beeps and **Low battery** displays on the handset.
- **Put in charger** displays on the handset.
- A battery is properly installed and the screen is blank.

### CAUTION:

#### To reduce the risk of fire or injury, read and follow these instructions:

- Use only the batteries provided or equivalent. To order a replacement, visit our website at [www.vtechphones.com](http://www.vtechphones.com) or call 1 (800) 595-9511. In Canada, go to [www.vtechcanada.com](http://www.vtechcanada.com) or call 1 (800) 267-7377.
- Do not dispose of the batteries in a fire. Check with local waste management codes for special disposal instructions.
- Do not open or mutilate the batteries. Released electrolyte is corrosive and may cause burns or injury to the eyes or skin. The electrolyte may be toxic if swallowed.
- Exercise care in handling batteries in order not to create a short circuit with conductive materials.
- Charge the batteries provided with or identified for use with this product only in accordance with the instructions and limitations specified in this manual.
- Observe proper polarity orientation between the battery and metallic contacts.
- To prevent fire or shock hazard, do not expose this product to water or any type of moisture.

# Appendix

## Troubleshooting

If you have difficulty with your telephone, please try the suggestions below. For customer service, visit our website at [www.vtechphones.com](http://www.vtechphones.com) or call 1 (800) 595-9511. In Canada, go to [www.vtechcanada.com](http://www.vtechcanada.com) or call 1 (800) 267-7377.

### **My telephone does not work at all.**

- Make sure the battery is installed and charged correctly (page 3). For optimum daily performance, return the handset to the telephone base or charger after use.
- Make sure the power adapter is securely plugged into an outlet not controlled by a wall switch.
- Make sure the telephone line cord is plugged firmly into the telephone base and the wall jack.
- Unplug the electrical power to the telephone base. Wait for approximately 15 seconds, then plug it back in. Allow up to one minute for the cordless handset and telephone base to synchronize.
- Charge the battery in the handset for up to 11 hours.
- If the battery is completely depleted, charge the handset for at least 30 minutes before use (page 4).
- Remove and install the battery again. If that still does not work, it may be necessary to purchase a new battery.
- Disconnect the telephone base from the telephone wall jack and plug in a working telephone. If the other telephone does not work, the problem is probably in the wiring or telephone service. Contact your telephone service provider.

### **There is no dial tone.**

- Try all the above suggestions.
- Move the handset closer to the telephone base. It may be out of range.
- The telephone line cord may be defective. Install a new telephone line cord.
- Disconnect the telephone base from the telephone wall jack and connect a different telephone. If there is no dial tone on this telephone either, the problem is in your wiring or telephone service. Contact your telephone service provider.

### **I cannot dial out.**

- Try all the above suggestions.
- Make sure there is a dial tone before dialing. It is normal if the handset takes a second or two to synchronize with the telephone base before producing a dial tone. Wait an extra second before dialing.
- If other telephones in your home are having the same problem, the problem is in the wiring or telephone service. Contact your telephone service provider (charges may apply).
- Eliminate any background noise. Mute the cordless handset before dialing, or dial from another room in your home with less background noise.

### **To register HS and See manual appear alternately on the handset and it does not work at all.**

- The handset may be deregistered from the telephone base. Refer to **Add and register a handset** on page 54 to register the handset to the telephone base.



# Appendix

## Troubleshooting

### **My cordless handset isn't performing normally.**

- Make sure you plug the power cord securely into the telephone base. Plug the power adapter into a different, working electrical outlet without a wall switch.
- Move the cordless handset closer to the telephone base. You may have moved out of range.
- Reset the telephone base. Unplug the electrical power. Wait for 15 seconds then plug it back in. Allow up to one minute for the cordless handset and telephone base to reset.
- Other electronic products such as HAM radios and other DECT phones can cause interference with your cordless phone. Try installing your phone as far away as possible from these types of electronic devices.

### **Low battery shows on the handset screen.**

- Place the handset in the telephone base or charger for recharging.
- Remove and install the battery again and use it until fully depleted, then charge the handset in the telephone base or charger for up to 11 hours.
- If the above measures do not correct the problem, replace the battery.

### **The battery does not charge in the handset or the handset battery does not accept charge.**

- Make sure the handset is placed in the telephone base or charger correctly.
- Remove and install the battery again, then charge for up to 11 hours.
- If the battery is completely depleted, charge the handset for at least 30 minutes before use (page 4).
- Purchase a new battery. Refer to the **Battery** section (page 59).

### **The CHARGE light is off.**

- Clean the charging contacts on the handset, telephone base and/or charger each month with a pencil eraser or a dry non-abrasive fabric.
- Make sure the power adapter and telephone line cord are plugged in properly (page 2).
- Unplug the power adapter. Wait for 15 seconds before plugging it back in. Allow up to one minute for the handset and telephone base to reset.

# Appendix

## Troubleshooting

### **The telephone does not ring when there is an incoming call.**

- Make sure the ringer volume of the handset and telephone base are not set to off (page 10 and page 11).
- Make sure the telephone line cord and power adapter are plugged in properly (page 2).
- The handset may be too far from the telephone base. Move it closer to the telephone base.
- There may be too many extension phones on the telephone line to allow all of them to ring simultaneously. Unplug some of them.
- If other telephones in your home are having the same problem, the problem is in the wiring or telephone service. Contact your telephone service provider (charges may apply).
- Other electronic products such as HAM radios and other DECT phones can cause interference with your cordless phone. Try installing your phone as far away as possible from these types of electronic devices.
- Test a working telephone at the telephone wall jack. If another telephone has the same problem, the problem is in the telephone wall jack. Contact your telephone service provider (charges may apply).
- The telephone line cord may be defective. Install a new telephone line cord.
- Remove and install the battery again and place the handset in the telephone base.
- Wait for the handset to synchronize with the telephone base. Allow up to one minute for this to take place.

# Appendix

## Troubleshooting

### **There is interference during a telephone conversation.**

#### **My calls fade out when I am using the cordless handset.**

- The handset may be out of range. Move it closer to the telephone base.
- If you subscribe to high-speed Internet service (DSL - digital subscriber line) through your telephone line, you must install a DSL filter between the telephone line cord and the telephone wall jack. The filter prevents noise and caller ID problems caused by DSL interference. Contact your DSL service provider for more information about DSL filters.
- Appliances or other cordless telephones plugged into the same circuit as the telephone base can cause interference. Try moving the appliance or telephone base to another outlet.
- Other electronic products such as HAM radios and other DECT phones can cause interference with your cordless phone. Try installing your phone as far away as possible from these types of electronic devices.
- If your telephone is plugged in with a modem or a surge protector, plug the telephone (or modem/surge protector) into a different location. If this doesn't solve the problem, relocate your telephone or modem farther apart from each other, or use a different surge protector.
- The location of your telephone base can impact the performance of your cordless phone. For better reception, install the telephone base in a centralized location within your home or office, away from walls or other obstructions. In many environments, elevating the telephone base improves overall performance.
- Disconnect the telephone base from the telephone wall jack and plug in a corded telephone. If calls are still not clear, the problem is probably in the wiring or telephone service. Contact your telephone service provider (charges may apply).
- If other telephones in your home are having the same problem, the problem is in the wiring or telephone service. Contact your telephone service provider (charges may apply).

#### **I get noise, static, or weak signals even when I'm near the telephone base.**

- If you subscribe to high-speed Internet service (DSL - digital subscriber line) through your telephone line, you must install a DSL filter between the telephone line cord and the telephone wall jack. The filter prevents noise and caller ID problems caused by DSL interference. Contact your DSL service provider for more information about DSL filters.
- You may be able to improve the performance of your cordless phone by installing your new telephone base as far as possible from any other existing cordless telephone system that may already be installed.
- Other electronic products such as HAM radios and other DECT phones can cause interference with your cordless phone. Try installing your phone as far away as possible from these types of electronic devices.
- Do not install this phone near a microwave oven or on the same electrical outlet. You may experience decreased performance while the microwave oven is operating.
- If you plug your phone in with a modem or a surge protector, plug the phone (or modem/surge protector) into a different location. If this does not solve the problem, relocate your phone or modem farther apart from one another, or use a different surge protector.
- Relocate your phone to a higher location. The phone may have better reception in a high area.
- If other phones in your home are having the same problem, contact your telephone service provider (charges may apply).

# Appendix

## Troubleshooting

### **I experience poor sound quality when using the speakerphone.**

- For increased sound quality while using the speakerphone, place the handset on a flat surface with the dialing keys facing up.

### **I hear other calls when using the telephone.**

- Disconnect the telephone base from the telephone wall jack. Plug in a different telephone. If you still hear other calls, the problem is probably in the wiring or telephone service. Contact your telephone service provider.

### **I hear noise on the cordless handset and the keys do not work.**

- Make sure the telephone line cord is plugged in securely.

### **My caller ID features are not working properly.**

- Caller ID is a subscription service. You must subscribe to this service from your telephone service provider for this feature to work on your telephone.
- The caller may not be calling from an area which supports caller ID.
- Both your and the caller's telephone service providers must use equipment compatible with the caller ID service.
- The caller ID information shows after the first or second ring.
- If you subscribe to high-speed Internet service (DSL - digital subscriber line) through your telephone line, you must install a DSL filter between the telephone line cord and the telephone wall jack. The filter prevents noise and caller ID problems caused by DSL interference. Contact your DSL service provider for more information about DSL filters.

### **The telephone does not receive caller ID while on a call.**

- Make sure you subscribe to caller ID with call waiting features provided by your telephone service provider.
- The caller may not be calling from an area which supports caller ID.
- Both your and the caller's telephone service providers must use equipment compatible with caller ID service.
- If you subscribe to high-speed Internet service (DSL - digital subscriber line) through your telephone line, you must install a DSL filter between the telephone line cord and the telephone wall jack. The filter prevents noise and caller ID problems caused by DSL interference. Contact your DSL service provider for more information about DSL filters.

# Appendix

## Troubleshooting

### Out of range or no pwr at base shows on the handset screen.

- The handset may be out of range. Move it closer to the telephone base.
- Make sure the power cord is securely plugged into the telephone base. Use a working electrical outlet not controlled by a wall switch.
- Reset your telephone by unplugging the power adapter from the telephone base. Disconnect the battery from the cordless handset. Wait for 15 seconds, then plug in the power adapter and install the battery again. Place the handset in the telephone base and allow up to one minute for the handset and telephone base to synchronize.
- Other electronic products such as HAM radios and other DECT phones can cause interference with your cordless phone. Try installing your phone as far away as possible from these types of electronic devices.

### and New voicemail show on the handset display and I don't know why.

- Your telephone has voicemail indication that is separate from the built-in answering system. If  and **New voicemail** appear on the handset, your telephone has received a signal from your telephone service provider that you have a voicemail message waiting for you to retrieve from them. Contact your telephone service provider for more information on how to access your voicemail.

### I cannot retrieve voicemail messages.

- Your telephone has both a built-in answering system and voicemail indication. They are independent features and each alerts you to new messages differently (page 47). If you subscribe to voicemail service from your telephone service provider (charges may apply), contact your telephone service provider for more information on how to access your voicemail.

### The answering system does not answer after the correct number of rings.

- Make sure the answering system is on. When the answering system is on, the /ANS ON/OFF light on the telephone base should be lit and **ANS ON** should show on the handset.
- If toll saver is selected, the number of rings changes to two when there are new messages waiting (page 44).
- If the memory is full or if the answering system is off, the answering system answers after 10 rings.
- In some cases, the answering system is affected by the ringing system used by your telephone service provider.
- If you subscribe to voicemail service, change the number of rings so that your answering system answers before your voicemail answers (page 47). To determine how many rings activate your voicemail, please contact your telephone service provider.
- If there is a fax machine connected to the same telephone line, try disconnecting the fax machine. If that solves the problem, consult your fax machine documentation for information on compatibility with answering systems.

# Appendix

## Troubleshooting

### **The outgoing announcement is not clear.**

- When recording the announcement, make sure you speak in a normal tone of voice towards the microphone of the handset.
- Make sure there is no background noise when recording.

### **The answering system does not record messages.**

- Make sure the answering system is on.
- When the answering machine memory is full, it does not record new messages until some old messages are deleted.
- If you subscribe to voicemail service, change the number of rings so that your answering system answers before your voicemail answers (page 47). To determine how many rings activate your voicemail, contact your telephone service provider.
- If there is a fax machine connected to the same telephone line, try disconnecting the fax machine. If that solves the problem, consult your fax machine documentation for information on compatibility with answering systems.

### **The messages on the answering system are very difficult to hear.**

- Press ▲/VOLUME on handset or VOL+ on the telephone base to increase the listening volume.

### **The messages on the answering system are incomplete.**

- If a caller leaves a very long message, part of it may be lost when the answering system disconnects the call after the preset recording time.
- If the memory on the answering system becomes full during a message, the answering system stops recording and disconnects the call.
- If the caller's voice is very soft, the answering system may stop recording and disconnect the call.

### **The answering system does not respond to remote commands.**

- Make sure your remote access code is correct (page 45).
- Make sure you are calling from a touch-tone telephone. When dialing a number, there should be tones. If there are clicks, then it is not a touch-tone telephone and cannot activate the answering system.
- The answering system may not detect the remote access code when your announcement is playing. Wait until the announcement is over before entering the code.
- There may be interference on the telephone line you are using. Press the dialing keys firmly when dialing.

# Appendix

## Troubleshooting

### **I subscribe to a nontraditional telephone service that uses my computer to establish connections, and my telephone doesn't work.**

- Make sure your computer is powered on.
- Make sure your Internet connection is working properly.
- Make sure that the software is installed and running for your nontraditional telephone service.
- Make sure to plug your USB telephone adapter into a dedicated USB port on your computer. Do not plug into a multiple port USB hub (USB splitter) that is not powered.
- In a few rare instances, the USB port on your computer may not have enough power. In these instances, try using a USB hub with its own external power supply.
- If you are using a firewall, it may prevent access to your nontraditional telephone service provider. Contact your service provider for more information.

### **I have accidentally set my LCD language to Spanish or French, and I don't know how to change it back to English.**

- While the phone is not in use, press **MENU** once then enter **✕364#**.
- While on a call, press **MENU** once then enter **✕364#**. Then the call ends automatically.

### **Common cure for electronic equipment.**

- If the telephone is not responding normally, put the cordless handset in the telephone base. If it does not respond, try the following (in the order listed):
  1. Disconnect the power to the telephone base.
  2. Disconnect the battery on the cordless handset.
  3. Wait a few minutes before connecting power to the telephone base.
  4. Install the battery again and place the cordless handset in the telephone base.
  5. Wait for the cordless handset to synchronize with the telephone base. Allow up to one minute for this to take place.

# Appendix

## Important safety instructions

When using your telephone equipment, basic safety precautions should always be followed to reduce the risk of fire, electric shock and injury, including the following:

1. Read and understand all instructions.
2. Follow all warnings and instructions marked on the product.
3. Unplug this product from the wall outlet before cleaning. Do not use liquid or aerosol cleaners. Use a damp cloth for cleaning.
4. Do not use this product near water such as near a bath tub, wash bowl, kitchen sink, laundry tub or swimming pool, or in a wet basement or shower.
5. Do not place this product on an unstable table, shelf, stand or other unstable surfaces.
6. Slots and openings in the back or bottom of the telephone base and handset are provided for ventilation. To protect them from overheating, these openings must not be blocked by placing the product on a soft surface such as a bed, sofa or rug. This product should never be placed near or over a radiator or heat register. This product should not be placed in any area where proper ventilation is not provided.
7. This product should be operated only from the type of power source indicated on the marking label. If you are not sure of the type of power supply in your home or office, consult your dealer or local power company.
8. Do not allow anything to rest on the power cord. Do not install this product where the cord may be walked on.
9. Never push objects of any kind into this product through the slots in the telephone base or handset because they may touch dangerous voltage points or create a short circuit. Never spill liquid of any kind on the product.
10. To reduce the risk of electric shock, do not disassemble this product, but take it to an authorized service facility. Opening or removing parts of the telephone base or handset other than specified access doors may expose you to dangerous voltages or other risks. Incorrect reassembling can cause electric shock when the product is subsequently used.
11. Do not overload wall outlets and extension cords.
12. Unplug this product from the wall outlet and refer servicing to an authorized service facility under the following conditions:
  - When the power supply cord or plug is damaged or frayed.
  - If liquid has been spilled onto the product.
  - If the product has been exposed to rain or water.
  - If the product does not operate normally by following the operating instructions. Adjust only those controls that are covered by the operation instructions. Improper adjustment of other controls may result in damage and often requires extensive work by an authorized technician to restore the product to normal operation.
  - If the product has been dropped and the telephone base and/or handset has been damaged.
  - If the product exhibits a distinct change in performance.
13. Avoid using a telephone (other than cordless) during an electrical storm. There is a remote risk of electric shock from lightning.
14. Do not use the telephone to report a gas leak in the vicinity of the leak. Under certain circumstances, a spark may be created when the adapter is plugged into the power outlet, or when the handset is replaced in its cradle. This is a common event associated with the closing of any electrical circuit. The user should not plug the phone into a power outlet, and should not put a charged handset into the cradle, if the phone is located in an environment containing concentrations of flammable or flame-supporting gases, unless there is adequate ventilation. A spark in such an environment could create a fire or explosion. Such environments might include: medical use of oxygen without adequate ventilation; industrial gases (cleaning solvents; gasoline vapors; etc.); a leak of natural gas; etc.
15. Only put the handset of your telephone next to your ear when it is in normal talk mode.
16. The power adapters are intended to be correctly oriented in a vertical or floor mount position. The prongs are not designed to hold the plug in place if it is plugged into a ceiling, under-the-table or cabinet outlet.

**SAVE THESE INSTRUCTIONS**



# Appendix

## Precautions for users of implanted cardiac pacemakers

Cardiac pacemakers (applies only to digital cordless telephones):

Wireless Technology Research, LLC (WTR), an independent research entity, led a multidisciplinary evaluation of the interference between portable wireless telephones and implanted cardiac pacemakers. Supported by the U.S. Food and Drug Administration, WTR recommends to physicians that:

### Pacemaker patients

- Should keep wireless telephones at least six inches from the pacemaker.
- Should NOT place wireless telephones directly over the pacemaker, such as in a breast pocket, when it is turned ON.
- Should use the wireless telephone at the ear opposite the pacemaker.

WTR's evaluation did not identify any risk to bystanders with pacemakers from other persons using wireless telephones.

## Operating range

This cordless telephone operates with the maximum power allowed by the Federal Communications Commission (FCC). Even so, this handset and telephone base can communicate over only a certain distance - which can vary with the locations of the telephone base and handset, the weather, and the layout of your home or office.

When the handset is out of range, the handset displays **Out of range or no pwr at base**.

If there is a call while the handset is out of range, it may not ring, or if it does ring, the call may not connect well when you press **TALK**. Move closer to the telephone base, then press **TALK** to answer the call.

If the handset moves out of range during a telephone conversation, there may be interference. To improve reception, move closer to the telephone base.

## ECO mode

This power conserving technology reduces power consumption for optimal battery performance, according to the distance between the telephone base and the handset. When the telephone base communicates with the handset, ECO mode will be activated automatically.

# Appendix

## Maintenance

### Taking care of your telephone

Your cordless telephone contains sophisticated electronic parts, so it must be treated with care.

### Avoid rough treatment

Place the handset down gently. Save the original packing materials to protect your telephone if you ever need to ship it.

### Avoid water

Your telephone can be damaged if it gets wet. Do not use the handset outdoors in the rain, or handle it with wet hands. Do not install the telephone base near a sink, bathtub or shower.

### Electrical storms

Electrical storms can sometimes cause power surges harmful to electronic equipment. For your own safety, take caution when using electrical appliances during storms.

### Cleaning your telephone

Your telephone has a durable plastic casing that should retain its luster for many years. Clean it only with a soft cloth slightly dampened with water or mild soap. Do not use excess water or cleaning solvents of any kind.

Remember that electrical appliances can cause serious injury if used when you are wet or standing in water. If the telephone base should fall into water, **DO NOT RETRIEVE IT UNTIL YOU UNPLUG THE POWER CORD AND TELEPHONE LINE CORD FROM THE WALL.** Then remove the telephone by the unplugged cords.

# Appendix

## About cordless telephones

- **Privacy:** The same features that make a cordless telephone convenient create some limitations. Telephone calls are transmitted between the telephone base and the cordless handset by radio waves, so there is a possibility that the cordless telephone conversations could be intercepted by radio receiving equipment within range of the cordless handset. For this reason, you should not think of cordless telephone conversations as being as private as those on corded telephones.
- **Electrical power:** The telephone base of this cordless telephone must be connected to a working electrical outlet. The electrical outlet should not be controlled by a wall switch. Calls cannot be made from the cordless handset if the telephone base is unplugged, switched off or if the electrical power is interrupted.
- **Potential TV interference:** Some cordless telephones operate at frequencies that may cause interference to televisions and VCRs. To minimize or prevent such interference, do not place the telephone base of the cordless telephone near or on top of a TV or VCR. If interference is experienced, moving the cordless telephone farther away from the TV or VCR often reduces or eliminates the interference.
- **Rechargeable batteries:** Exercise care in handling batteries in order not to create a short circuit with conducting material such as rings, bracelets, and keys. The battery or conductor may overheat and cause harm. Observe proper polarity between the battery and the battery charger.
- **Nickel-metal hydride rechargeable batteries:** Dispose of these batteries in a safe manner. Do not burn or puncture the battery. Like other batteries of this type, if burned or punctured, they could release caustic material which could cause injury.

## The RBRC<sup>®</sup> seal

The RBRC<sup>®</sup> seal on the nickel-metal hydride battery indicates that VTech Communications, Inc. is voluntarily participating in an industry program to collect and recycle these batteries at the end of their useful lives, when taken out of service within the United States and Canada.

The RBRC<sup>®</sup> program provides a convenient alternative to placing used nickel-metal hydride batteries into the trash or municipal waste, which may be illegal in your area.

VTech's participation in RBRC<sup>®</sup> makes it easy for you to drop off the spent battery at local retailers participating in the RBRC<sup>®</sup> program or at authorized VTech product service centers. Please call **1 (800) 8 BATTERY<sup>™</sup>** for information on Ni-MH battery recycling and disposal bans/restrictions in your area. VTech's involvement in this program is part of its commitment to protecting our environment and conserving natural resources.

**RBRC<sup>®</sup> is a registered trademark of Rechargeable Battery Recycling Corporation.**



# Appendix

## Limited warranty

### What does this limited warranty cover?

The manufacturer of this VTech Product warrants to the holder of a valid proof of purchase (“Consumer” or “you”) that the Product and all accessories provided in the sales package (“Product”) are free from defects in material and workmanship, pursuant to the following terms and conditions, when installed and used normally and in accordance with the Product operating instructions. This limited warranty extends only to the Consumer for Products purchased and used in the United States of America and Canada.

### What will VTech do if the Product is not free from defects in materials and workmanship during the limited warranty period (“Materially Defective Product”)?

During the limited warranty period, VTech’s authorized service representative will repair or replace at VTech’s option, without charge, a Materially Defective Product. If we repair the Product, we may use new or refurbished replacement parts. If we choose to replace the Product, we may replace it with a new or refurbished Product of the same or similar design. We will retain defective parts, modules, or equipment. Repair or replacement of the Product, at VTech’s option, is your exclusive remedy. VTech will return the repaired or replacement Products to you in working condition. You should expect the repair or replacement to take approximately 30 days.

### How long is the limited warranty period?

The limited warranty period for the Product extends for ONE (1) YEAR from the date of purchase. If VTech repairs or replaces a Materially Defective Product under the terms of this limited warranty, this limited warranty also applies to the repaired or replacement Product for a period of either (a) 90 days from the date the repaired or replacement Product is shipped to you or (b) the time remaining on the original one-year warranty; whichever is longer.

### What is not covered by this limited warranty?

This limited warranty does not cover:

1. Product that has been subjected to misuse, accident, shipping or other physical damage, improper installation, abnormal operation or handling, neglect, inundation, fire, water or other liquid intrusion; or
2. Product that has been damaged due to repair, alteration or modification by anyone other than an authorized service representative of VTech; or
3. Product to the extent that the problem experienced is caused by signal conditions, network reliability, or cable or antenna systems; or
4. Product to the extent that the problem is caused by use with non-VTech accessories; or
5. Product whose warranty/quality stickers, product serial number plates or electronic serial numbers have been removed, altered or rendered illegible; or
6. Product purchased, used, serviced, or shipped for repair from outside the United States of America or Canada, or used for commercial or institutional purposes (including but not limited to Products used for rental purposes); or
7. Product returned without a valid proof of purchase (see item 2 on the next page); or
8. Charges for installation or set up, adjustment of customer controls, and installation or repair of systems outside the unit.

# Appendix

## Limited warranty

### How do you get warranty service?

To obtain warranty service in the USA, please visit our website at [www.vtechphones.com](http://www.vtechphones.com) or call 1 (800) 595-9511. In Canada, go to [www.vtechcanada.com](http://www.vtechcanada.com) or call 1 (800) 267-7377.

**NOTE:** Before calling for service, please review the user's manual - a check of the Product's controls and features may save you a service call.

Except as provided by applicable law, you assume the risk of loss or damage during transit and transportation and are responsible for delivery or handling charges incurred in the transport of the Product(s) to the service location. VTech will return repaired or replaced Product under this limited warranty. Transportation, delivery or handling charges are prepaid. VTech assumes no risk for damage or loss of the Product in transit. If the Product failure is not covered by this limited warranty, or proof of purchase does not meet the terms of this limited warranty, VTech will notify you and will request that you authorize the cost of repair prior to any further repair activity. You must pay for the cost of repair and return shipping costs for the repair of Products that are not covered by this limited warranty.

### What must you return with the Product to get warranty service?

1. Return the entire original package and contents including the Product to the VTech service location along with a description of the malfunction or difficulty; and
2. Include a "valid proof of purchase" (sales receipt) identifying the Product purchased (Product model) and the date of purchase or receipt; and
3. Provide your name, complete and correct mailing address, and telephone number.

### Other limitations

This warranty is the complete and exclusive agreement between you and VTech. It supersedes all other written or oral communications related to this Product. VTech provides no other warranties for this Product. The warranty exclusively describes all of VTech's responsibilities regarding the Product. There are no other express warranties. No one is authorized to make modifications to this limited warranty and you should not rely on any such modification.

**State/Provincial Law Rights:** This warranty gives you specific legal rights, and you may also have other rights, which vary from state to state or province to province.

**Limitations:** Implied warranties, including those of fitness for a particular purpose and merchantability (an unwritten warranty that the Product is fit for ordinary use) are limited to one year from the date of purchase. Some states/provinces do not allow limitations on how long an implied warranty lasts, so the above limitation may not apply to you. In no event shall VTech be liable for any indirect, special, incidental, consequential, or similar damages (including, but not limited to lost profits or revenue, inability to use the Product or other associated equipment, the cost of substitute equipment, and claims by third parties) resulting from the use of this Product. Some states/provinces do not allow the exclusion or limitation of incidental or consequential damages, so the above limitation or exclusion may not apply to you.

**Please retain your original sales receipt as proof of purchase.**

# Appendix

## FCC, ACTA and IC regulations

### FCC Part 15

This equipment has been tested and found to comply with the requirements for a Class B digital device under Part 15 of the Federal Communications Commission (FCC) rules. These requirements are intended to provide reasonable protection against harmful interference in a residential installation. This equipment generates, uses and can radiate radio frequency energy and, if not installed and used in accordance with the instructions, may cause harmful interference to radio communications. However, there is no guarantee that interference will not occur in a particular installation. If this equipment does cause harmful interference to radio or television reception, which can be determined by turning the equipment off and on, the user is encouraged to try to correct the interference by one or more of the following measures:

- Reorient or relocate the receiving antenna.
- Increase the separation between the equipment and receiver.
- Connect the equipment into an outlet on a circuit different from that to which the receiver is connected.
- Consult the dealer or an experienced radio/TV technician for help.

Changes or modifications to this equipment not expressly approved by the party responsible for compliance could void the user's authority to operate the equipment.

This device complies with Part 15 of the FCC rules. Operation is subject to the following two conditions: (1) this device may not cause harmful interference, and (2) this device must accept any interference received, including interference that may cause undesired operation. Privacy of communications may not be ensured when using this telephone.

To ensure safety of users, the FCC has established criteria for the amount of radio frequency energy that can be safely absorbed by a user or bystander according to the intended usage of the product. This product has been tested and found to comply with the FCC criteria. The handset may be safely held against the ear of the user. The telephone base shall be installed and used such that parts of the user's body other than the hands are maintained at a distance of approximately 20 cm (8 inches) or more.

This Class B digital apparatus complies with Canadian ICES-003.

### FCC Part 68 and ACTA

This equipment complies with Part 68 of the FCC rules and with technical requirements adopted by the Administrative Council for Terminal Attachments (ACTA). The label on the back or bottom of this equipment contains, among other things, a product identifier in the format US:AAAEQ##TXXXX. This identifier must be provided to your telephone service provider upon request.

The plug and jack used to connect this equipment to premises wiring and the telephone network must comply with applicable Part 68 rules and technical requirements adopted by ACTA. A compliant telephone cord and modular plug is provided with this product. It is designed to be connected to a compatible modular jack that is also compliant. An RJ11 jack should normally be used for connecting to a single line and an RJ14 jack for two lines. See the installation instructions in the user's manual.

The Ringer Equivalence Number (REN) is used to determine how many devices you may connect to your telephone line and still have them ring when you are called. The REN for this product is encoded as the 6th and 7th characters following the US: in the product identifier (e.g., if ## is 03, the REN is 0.3). In most, but not all areas, the sum of all RENs should be five (5.0) or less. For more information, please contact your telephone service provider.

This equipment may not be used with Party Lines. If you have specially wired alarm dialing equipment connected to your telephone line, ensure the connection of this equipment does not disable your alarm equipment. If you have questions about what will disable alarm equipment, consult your telephone service provider or a qualified installer.

# Appendix

## FCC, ACTA and IC regulations

If this equipment is malfunctioning, it must be unplugged from the modular jack until the problem has been corrected. Repairs to this telephone equipment can only be made by the manufacturer or its authorized agents. For repair procedures, follow the instructions outlined under the Limited warranty. If this equipment is causing harm to the telephone network, the telephone service provider may temporarily discontinue your telephone service. The telephone service provider is required to notify you before interrupting service. If advance notice is not practical, you will be notified as soon as possible. You will be given the opportunity to correct the problem and the telephone service provider is required to inform you of your right to file a complaint with the FCC. Your telephone service provider may make changes in its facilities, equipment, operation, or procedures that could affect the proper functioning of this product. The telephone service provider is required to notify you if such changes are planned.

If this product is equipped with a corded or cordless handset, it is hearing aid compatible.

If this product has memory dialing locations, you may choose to store emergency telephone numbers (e.g., police, fire, medical) in these locations. If you do store or test emergency numbers, please:

Remain on the line and briefly explain the reason for the call before hanging up.

Perform such activities in off-peak hours, such as early morning or late evening.

### Industry Canada

Operation is subject to the following two conditions: (1) this device may not cause harmful interference, and (2) this device must accept any interference, including interference that may cause undesired operation.

The term "IC:" before the certification/registration number only signifies that the Industry Canada technical specifications were met.

The Ringer Equivalence Number (REN) for this terminal equipment is 0.1. The REN is an indication of the maximum number of devices allowed to be connected to a telephone interface. The termination on an interface may consist of any combination of devices subject only to the requirement that the sum of the RENs of all the devices does not exceed five.

This product meets the applicable Industry Canada technical specifications.

## Technical specifications

Frequency control	Crystal controlled PLL synthesizer
Transmit frequency	Handset: 1921.536-1928.448 MHz Telephone base: 1921.536-1928.448MHz
Channels	5
Nominal effective range	Maximum power allowed by FCC and IC. Actual operating range may vary according to environmental conditions at the time of use.
Power requirements	Handset: 2.4V Ni-MH battery Telephone base: 6V DC @ 400mA Charger: 6V AC @ 300mA
Memory	Handset directory: 50 memory locations; up to 30 digits and 15 characters Handset caller ID log: 50 memory locations; up to 24 digits and 15 characters

# Index

## A

About cordless telephones 71  
Add a directory entry 29-30  
Add a handset 54  
Add a speed dial entry 33  
Alphabetical search 31  
Answer a call 19  
Answering system 41-53  
Answering system and voicemail 47

## B

Battery 3, 4, 59  
Battery charging 4  
Battery installation 3

## C

Caller ID 35-40  
Caller ID log screen messages 40  
Call intercept 49  
Call screening 44, 49  
Call transfer 23  
Call waiting 20  
Chain dialing 22  
Charger installation 2  
Charging 4  
Check voicemail 22  
Clear voicemail 16  
Clock 13

## D

Date 13  
Delete a directory entry 32  
Delete a memo 51  
Delete a redial entry 21  
Delete a speed dial entry 34  
Deregister handsets 55  
Dial a caller ID log entry 37  
Dial a directory entry 31  
Dialing pause 29, 30, 32, 39  
Directory 28-34  
DSL filter 2

## E

ECO 58, 69  
Edit a directory entry 32  
End a call 19

## F

Find handset 24  
Flash 20

## H

Handset indicators 58  
Handset layout 8-9  
Handset lights 58  
Handset locator 24  
Handset ringer 10  
Handset icons 58

## I

Icons 58  
Implanted cardiac pacemakers 69  
Important safety instructions 68  
Indicators 58  
Installation 2, 3, 5-6  
Intercom 26-27

## J

Join a call 25

## K

Key tone 17

## L

Language 14  
Layout 7, 8, 9  
Lights 58  
Limited warranty 72-73  
Listening volume 20, 50

## M

Make a call 19  
Menu 10  
Message alert tone 45  
Message capacity 48  
Message playback 50  
Message window displays 52  
Missed call indicator 36  
Multiple handset use 25-27  
Mute 20

## N

New message indication 48

## O

Operating range 69  
Operation 19-24, 47-53



# Index

## P

Pacemaker patients 69  
Paging handsets 24  
Parts checklist 1  
Play a memo 51  
Precautions for users of implanted  
cardiac pacemakers 69  
Pulse dialing 18

## Q

Quiet mode 12

## R

Record a memo 51  
Record an announcement 41  
Recording time 46  
Redial 21  
Register a handset 54  
Remote access 53  
Replace a handset 55  
Review a caller ID log entry 37  
Review the directory 31  
Ringer 10

## S

Safety instructions 68  
Screen messages 40, 56-57  
Set date and time 13  
Settings 10-18, 41-46  
Share an outside call 25  
Speed dial 33-34  
Store a directory entry 29-30  
Store a speed dial entry 33

## T

Technical specifications 75  
Telephone base installation 2  
Telephone base layout 7  
Telephone base lights 58  
Telephone base ringer 11  
Temporary tone dialing 21  
Time and date setting 13  
Tone dialing 18, 21  
Troubleshooting 60-67

## U

Using the menu 10

## V

Voicemail 16, 22, 47  
Volume 10, 11, 20, 42, 49, 50

## W

Wall mount installation 5, 6  
Warranty 72-73  
Website 23

VTECH TELECOMMUNICATIONS LTD.  
A member of THE VTECH GROUP OF COMPANIES.  
VTech is the registered trademark of VTech Holdings Limited.  
Copyright © 2012 for VTECH TELECOMMUNICATIONS LTD.  
All rights reserved. Version 1 05/12.

91-006120-010-100

**vtech**<sup>®</sup>