

vtech®

SN5127

Amplified Cordless Answering System with
Big Buttons and Display

Go to www.vtechphones.com
to register your product for
enhanced warranty support and
latest VTech product news.



Quick start guide

Congratulations

on purchasing your new VTech product. Before using this telephone, please read **Important safety instructions**.

This quick start guide provides you with basic installation and use instructions. A limited set of features are described in abbreviated form. Please refer to the online user's manual for a full set of installation and operation instructions at **www.vtechphones.com**.



Telephones identified with this logo have reduced noise and interference when used with most T-coil equipped hearing aids and cochlear implants. The TIA-1083 Compliant Logo is a trademark of the Telecommunications Industry Association. Used under license.



The ENERGY STAR® program (www.energystar.gov) recognizes and encourages the use of products that save energy and help protect our environment. We are proud to mark this product with the ENERGY STAR® label indicating it meets the latest energy efficiency guidelines.

Table of contents	
What's in the box	1
Connect and install	2
Connect the telephone base.....	2
Install the battery.....	3
Charge the battery.....	4
Battery backup mode.....	5
Mount the telephone base (optional).....	6
Setup	8
Date and time.....	8
Voice guide to set Smart call blocker.....	10
Voice guide to set answering system.....	12
SOS emergency call.....	13
Photo speed dial.....	19
LCD language.....	23
Talking digits.....	24
Key tone.....	25
Caller ID announce on/off.....	26
Use caller ID to automatically set date and time.....	27
Voicemail number.....	28
Clear voicemail indicator.....	29
Home area code.....	30
Dial mode.....	31
Alarm reminder and melody.....	32
Operate	35
Display.....	35
Make a call.....	36
Answer a call.....	36
End a call.....	37
Speakerphone.....	37

Volume.....	37	Delete a phonebook entry.....	51
Make SOS emergency call.....	38	Save a redial entry to the phonebook.....	52
Temporary ringer silencing.....	39	Edit a phonebook entry.....	53
Call waiting.....	39	Caller ID	54
Redial.....	40	Review caller ID log entry.....	54
Photo/memory speed dial.....	40	Save a caller ID log entry to the phonebook.....	55
Temporary tone dialing.....	41	Dial a caller ID log entry.....	56
Audio Assist®.....	41	Delete a caller ID log entry.....	56
Equalizer.....	42	Smart call blocker*	57
Find handset.....	42	Call categories.....	58
Join a call in progress.....	43	Set Smart call blocker on/off...	60
Intercom.....	44	Set welcome calls.....	61
Call transfer using Intercom.....	46	Set unwelcome calls.....	65
Phonebook	48	Control calls without numbers.....	67
Add a phonebook entry.....	48		
Review phonebook entry.....	50		
Dial a phonebook entry.....	51		

Control uncategorized calls.....	68	Play the previous message.....	80
Screen calls without numbers.....	69	Delete a message.....	80
Screen uncategorized calls.....	70	Delete all messages.....	81
Add a screened number to the allow list or block list.....	71	Remote access.....	82
Option while on a call.....	71	Set remote access code.....	83
Answering system.....	72	Additional devices.....	84
About the built-in answering system and voicemail service...	72	Add and register expansion handset.....	84
Built-in answering system VS Voicemail service.....	72	Add and register photo speed dial handset.....	85
Turn the built-in answering system on or off.....	74	Device setup.....	86
Set number of rings.....	76	Audio doorbell.....	88
Message playback.....	78	Test device signal strength...	100
Skip a message.....	79	Device monitoring.....	102
Repeat the playing message...	79	Limited warranty.....	103
		Technical specifications.....	105



What's in the box

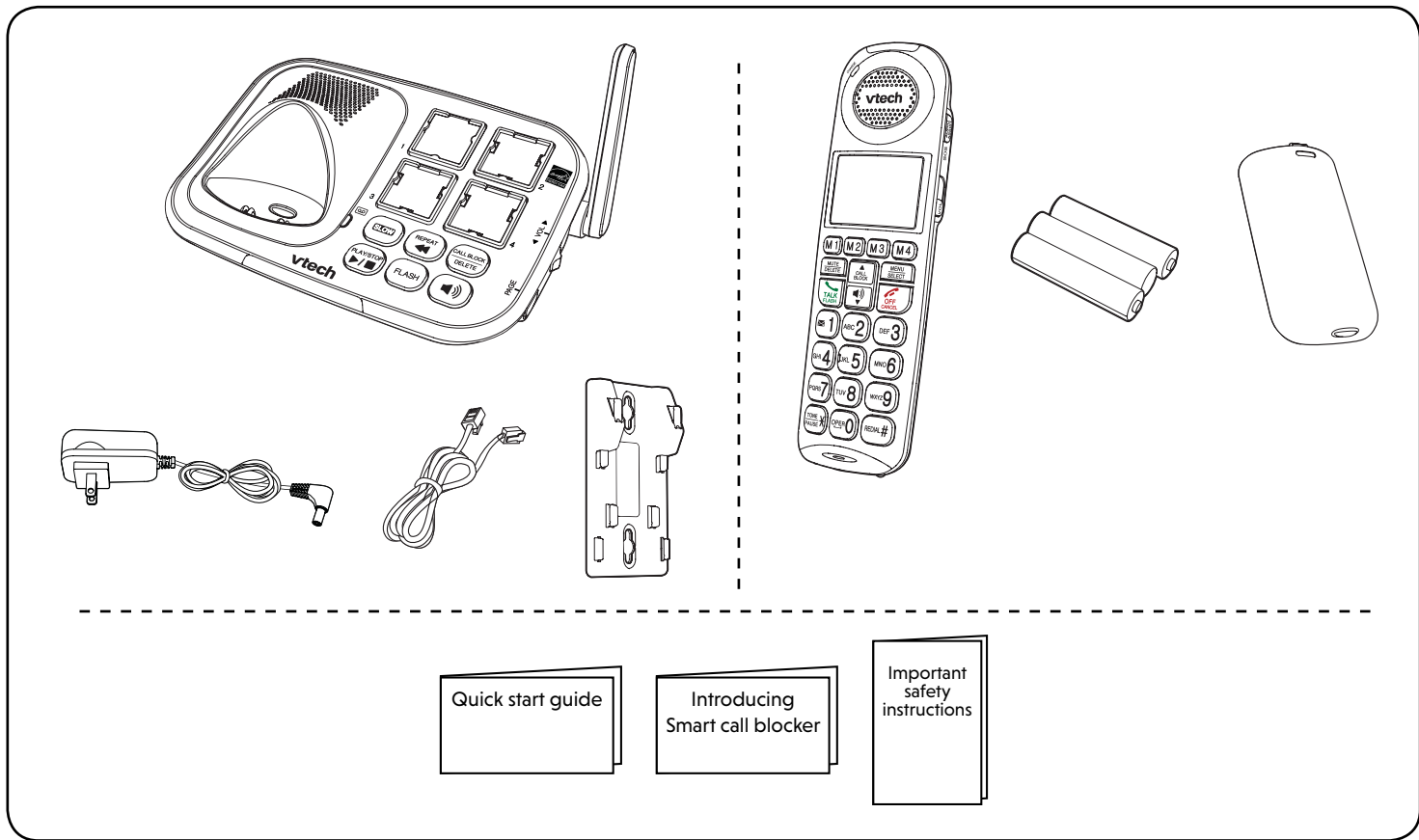



Connect and install

Connect the telephone base

If you subscribe to digital subscriber line (DSL) high-speed Internet service through your telephone line, make sure you connect a DSL filter (not included) to the telephone wall jack.

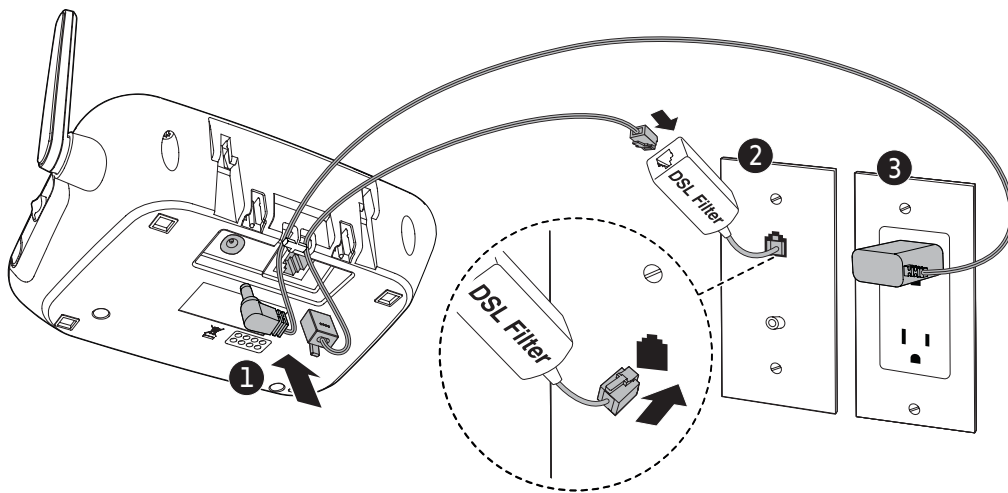

Install the battery

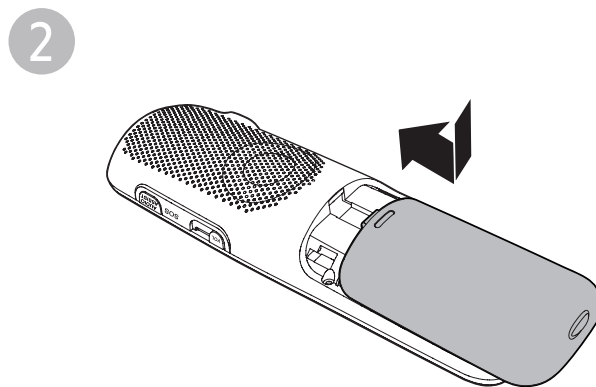
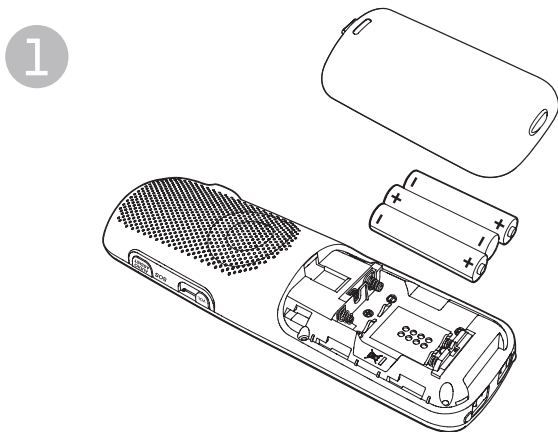

⚠ CAUTIONS

- Use only the rechargeable batteries provided or replacement batteries (model BT205662).
- Do not use other alkaline, manganese or Ni-Cd batteries, nor other non-rechargeable batteries for operating the cordless handset. They may cause failure or malfunction of the handset or the telephone system.

📄 NOTES

- Charge the batteries provided with this product only in accordance with the instructions and limitations specified in this quick start guide.
- If the handset will not be used for a long time, disconnect and remove the batteries to prevent possible leakage.



Connect and install

Charge the battery

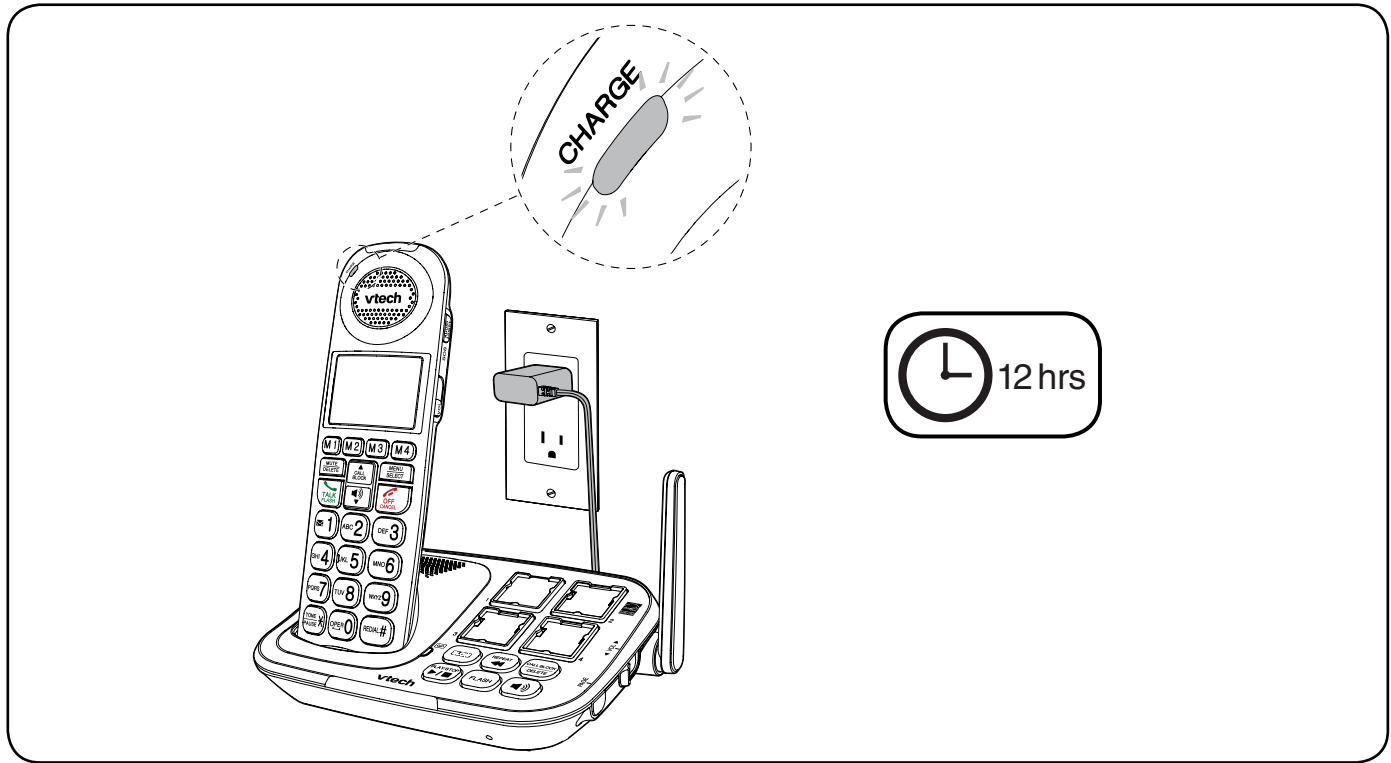

Battery backup mode

When there is a power failure, the handset displays **Put HS on base to power base** and **Out of range OR No pwr at base** alternately. Put the charged handset in the telephone base to back up the telephone base power for some basic phone operations for a short period of time. During this period, you cannot use the answering system.

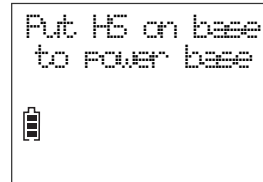

When the handset is put in the telephone base, it displays **Powering base... Don't pick up.**

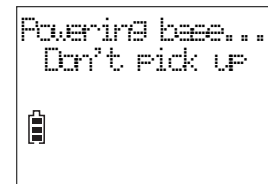

You may use the handset for making or answering calls via the handset speakerphone, but do not pick up the handset while using it.

NOTE

If you have more than one handset, all handsets display **Pwr outage mode** after entering the battery backup mode. At this time, use other handsets for some basic phone operations.



Connect and install

Mount the telephone base (optional)

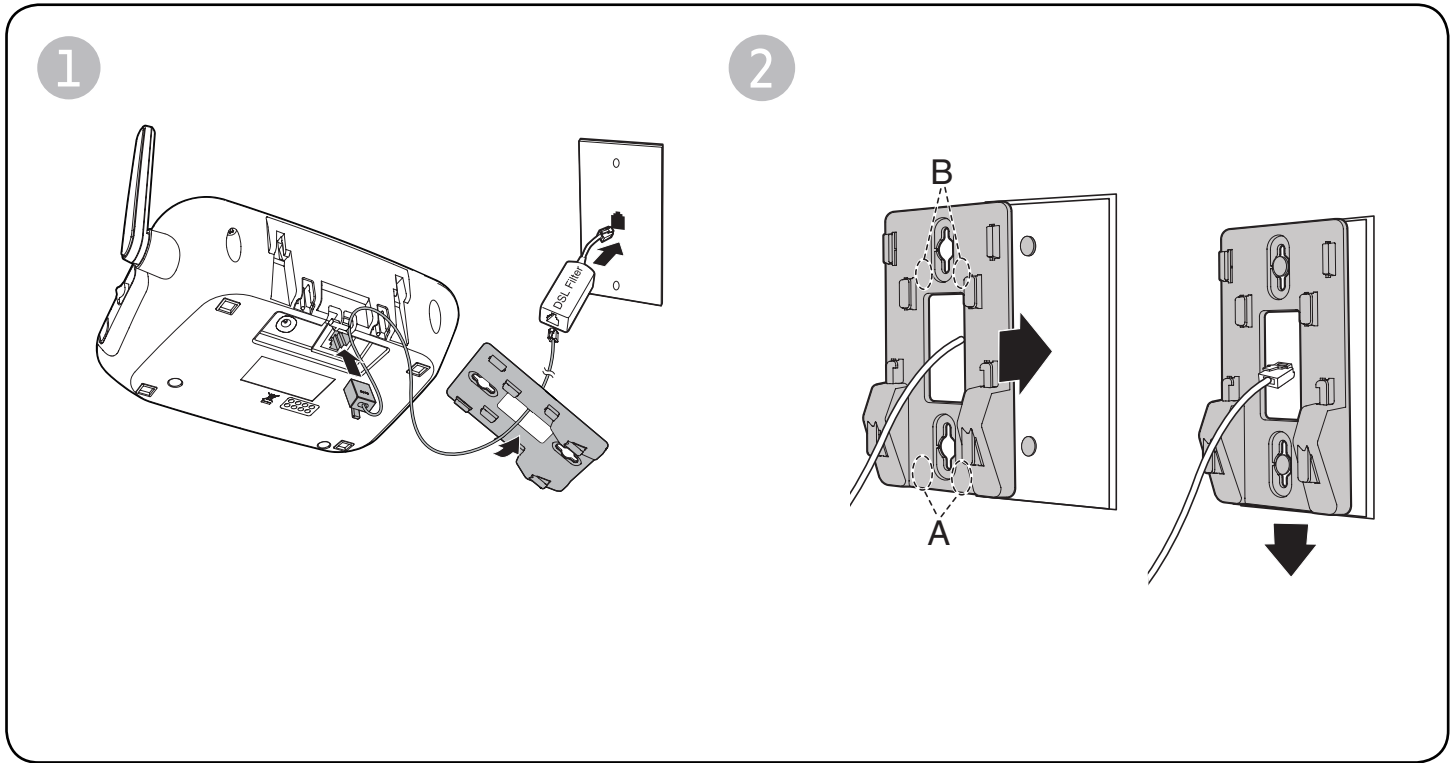

1. Connect and install

3

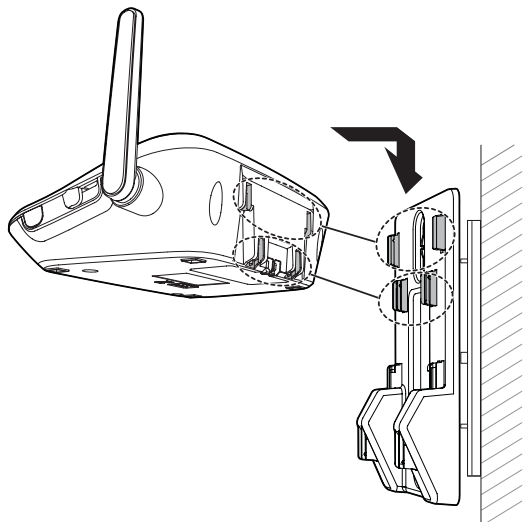

4

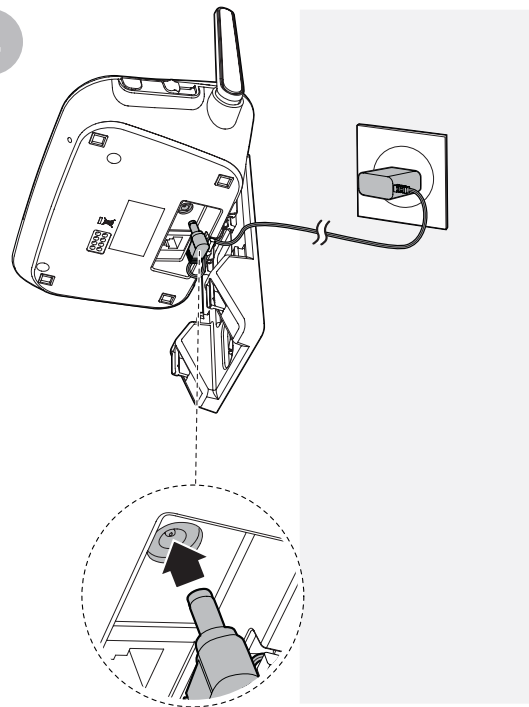



Setup

Date and time

After you install your telephone or power returns following a power outage and battery depletion, the handset will prompt you to set the date and time, and to configure the Smart call blocker and answering system through the voice guides.

Follow the steps below to set the date and time. For example, if the date is 31 December, 2018, and the time is 10:59 PM:

When the handset prompts you to set the date and time...

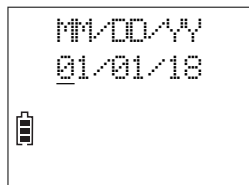

Enter the month (**MM**), day (**DD**), and year (**YY**).

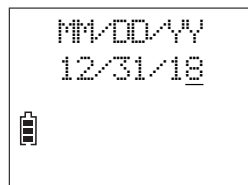

Press **SELECT**.

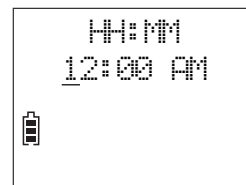

Enter the hour (**HH**) and minute (**MM**).

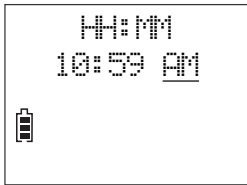

Press any number key to toggle between **AM** and **PM**.

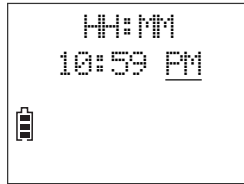

Press **SELECT** to save.

NOTE

Make sure you set the date and time including the year correctly; otherwise the answering system does not announce the correct day of the week for your recorded messages time stamp.

TIP If you subscribe to caller ID service, the day, month and time are set automatically with each incoming call.

- OR -

When the handset is not in use:

1. Press **MENU**.
2. Press ▼ or ▲ to scroll to **Set date/time**.
3. Press **SELECT**, and then follow the **Date and time** steps to set the date and time.

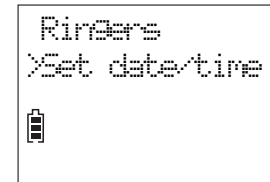



Setup

Voice guide to set Smart call blocker

After the date and time setting is done or skipped, the cordless handset then prompts if you want to set Smart call blocker. For more details on **Smart call blocker**, see page 57.

You can follow the voice guide to set your telephone system to allow or to screen all incoming calls, or to screen calls that do not display a phone number.

When the handset prompts you to set Smart call blocker via voice guide...

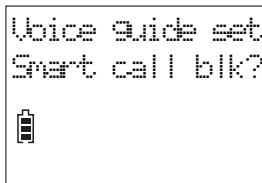

"Hello! This voice guide will assist you with the basic setup of Smart call blocker..."

1



Press **SELECT**.

2



Listen to the instructions and then choose one of the options.

On the cordless handset:



Press **1** if you want to screen calls with telephone numbers that are not saved in your Phonebook, Allow list or Star name list;



Press **2** if you only want to screen calls that do not display a phone number; or



Press **3** if you do not want to screen calls, and want to allow all incoming calls to get through.

NOTE

- If you select option **1** to screen calls, we recommend that you add the phone numbers of your family members and friends, and desired businesses to your **Phonebook** (see page 48 or **Allow list** (see page 61), or add their names to the **Star name list** (see page 62). This will avoid Smart call blocker to screen their calls.

TIP

- Read the **Introducing Smart call blocker** leaflet provided in your package to learn how to set up your Smart call blocker.



Setup

Voice guide to set answering system

After the Smart call blocker setting is done or skipped, the handset will then prompt if you want to set up the answering system.

This feature assists you to do the basic setup of the answering system. You can follow the voice guide to record your own announcement, set the number of rings and the message alert tone.

When the handset prompts you to set up the answering system via voice guide...

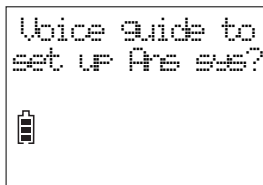

1



Press **SELECT**.



"This voice guide will assist you with the basic setup of your answering system."

2



Set up your answering system by inputting the designated numbers as instructed in the voice guide.

SOS emergency call

The **AUDIO ASSIST/SOS** button on the cordless handset can function as SOS emergency button. It lets you quickly page other system devices and call the preset external numbers for help in an emergency.

You can preset up to five SOS numbers.

If you have purchased and registered a Wearable home SOS pendant (**SN7022**) to your telephone system, the SOS pendant will function as same as the SOS emergency button of the cordless handset.

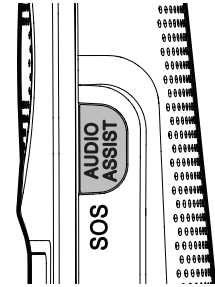

2. Setup

⚠ CAUTIONS

- To ensure proper operation, the telephone system must be installed according to the installation instructions on page 2 to page 4. To verify that the telephone system is operating properly and can successfully make emergency calls to the preset numbers, the telephone system must be tested immediately after installation, and periodically thereafter, according to the setup instructions on page 15 to page 18, and the operations on page 38.
- The telephone system cannot make an emergency call when other equipment (telephone, answering system, computer modem, etc.) connected to the same phone line is in use.
- Do not solely rely on the SOS button on the cordless handset, or the Wearable home SOS pendant (**SN7022**, purchased separately), for getting help in case of emergency. The functionality of the SOS emergency call is dependent on the phone settings and network availability.

📄 NOTE

- We recommend you set all five SOS numbers to maximize the possibility of receiving response from others when you make an emergency call.



Setup

How does SOS emergency call work?

- To make an emergency call, press and hold **AUDIO ASSIST/SOS** on the right side of the cordless handset for three seconds. The telephone base announces "*Emergency mode is activated*". The handset then pages all system devices. All devices ring an alert tone and the handset screen shows **SOS mode** for 20 seconds. After that, the telephone then calls the preset SOS numbers in sequence until the call is answered.
 - The telephone enables internal SOS alert by default. When this feature is enabled, the telephone pages all system devices before calling the preset SOS numbers.
 - If you disable internal SOS alert (see page 16), the telephone calls the preset SOS numbers directly when you press and hold **AUDIO ASSIST/SOS** on the cordless handset.
- When the SOS call to the preset external number is answered, the call receiver hears an SOS message. You can record your own message or use the default message (see page 17).
- The SOS message played by the telephone asks the SOS call receiver to respond by pressing a number key. After the call receiver presses a number key, you can then talk to the call receiver with your handset.
- When the SOS emergency call is answered by answering machine or voicemail, the call will be terminated after 60 seconds. The telephone then dials the next SOS number in sequence.
- When none of the preset SOS numbers answer, the telephone re-calls the preset SOS numbers in sequence until the call is answered. The telephone will call all the preset SOS numbers for 3 times before aborting the operation when none of the calls are answered.

Set SOS emergency numbers

1 Press **SELECT**.

2 Press **SELECT**.

3 Press **SELECT**.

4 Press **SELECT**. Scroll to select **SOS 1**, **SOS 2**, **SOS 3**, **SOS 4**, or **SOS 5**, and then press **SELECT**.

5 Press **SELECT** again to add an emergency number.

6 Enter the number. Then, press **SELECT**.

7 Enter the name. Then, press **SELECT**.



Setup

Enable or disable internal SOS alert

Internal SOS alert is enabled by default.

When you press and hold **AUDIO ASSIST/SOS** to make an emergency call, the telephone pages all registered system devices for 20 seconds. After that, the telephone then calls the five preset SOS numbers in sequence, until the call is answered.

You can disable this setting to allow you to make emergency calls directly to the preset SOS numbers.

1



MENU
SELECT

Press **MENU** on the handset when it is not in use.

CALL
BLOCK

Direct memory
>Set SOS



2



MENU
SELECT

Scroll to **Set SOS**, and then
press **SELECT**.

CALL
BLOCK

>Call internal
SOS number



3



MENU
SELECT

Press to select
Call internal.

CALL
BLOCK

CALL INTERNAL
>Enable

4



MENU
SELECT

Scroll to select **Enable** or
Disable, and then press **SELECT**.

16

Record SOS message

When you make an emergency call with the **AUDIO ASSIST/SOS** button on the cordless handset, the SOS message is played to the call receiver after he/she picks up. The default SOS message is "This is an emergency call. Please press any number key to start the conversation." You can record your own message using the cordless handset.



MENU
SELECT

Press **MENU** on the handset when it is not in use.



Direct memory
>Set SOS



SOS number
>SOS message

>Record anc
Play anc



"Record after the tone. Press STOP when you are done."

RECORD SOS
5-STOP



MENU
SELECT

Scroll to **Set SOS**, and then press **SELECT**.



MENU
SELECT

Scroll to **SOS message**, and then press **SELECT**.



MENU
SELECT

Press **SELECT** to select **Record anc**.



Speak toward the cordless handset to record your message. Press **5** when done.

NOTE Make sure your recorded SOS message includes your name, your SOS message, and a request to the far-end caller on pressing any number key to start a conversation.



Setup

Play or reset SOS message

1



MENU
SELECT

Press **MENU** on the handset when it is not in use.



Direct memory
>Set SOS
[Battery icon]

2



MENU
SELECT

Scroll to **Set SOS**, and then press **SELECT**.



SOS number
>SOS message
[Battery icon]

3



MENU
SELECT

Scroll to **SOS message**, and then press **SELECT**.



Play annc
>Reset annc
[Battery icon]

4



MENU
SELECT

Scroll to select **Play annc** or **Reset annc**, and then press **SELECT**. If you select **Reset annc**, press **SELECT** twice.

Photo speed dial

There are four photo speed dial memory keys **1** to **4** on the telephone base, and four direct memory keys **M1** to **M4** on the cordless handset.

You can store the telephone numbers you wish to quick dial to the photo speed dial keys. When you set the four photo speed dial keys **1**, **2**, **3** and **4** on the telephone base, the same numbers will also automatically set in the **M1**, **M2**, **M3** and **M4** keys on the cordless handset.

☀ TIP

- We recommend you store at least two contacts that you may need to call them more often or immediately to photo speed dial keys **1** and **2**.

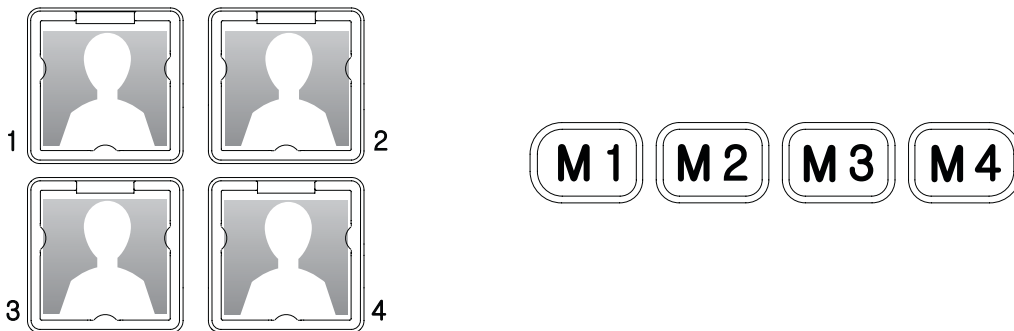



Setup

Photo speed dial

Store a photo speed dial entry:

1



Press **MENU** when the handset is not in use.

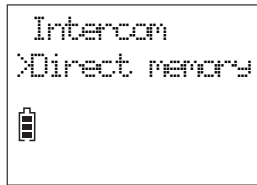

2



Scroll to **Direct memory**, and then press **SELECT**.

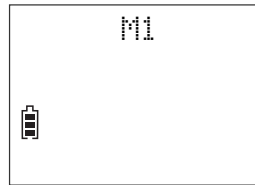

3



Scroll to select **M1, M2, M3, or M4**, and then press **SELECT**.

4



Press **SELECT** again to add the speed dial number.

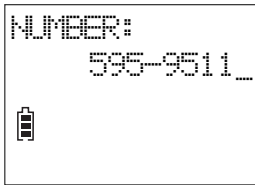

5

MENU
SELECT

Enter the phone number,
and then press **SELECT**.

6

MENU
SELECT

Enter the name, and then
press **SELECT** to save.

NOTE

- To store another photo speed dial entry, repeat the steps.



Setup

Photo speed dial

Insert photos for speed dial keys:

You can insert photos into the photo speed dial compartments, or write the contact names on cards and insert them into the compartments.

NOTE

The telephone base is shipped with protective stickers covering the photo speed dial compartments. Remove the protective sticker before use.

1. Remove the photo speed dial compartment cover.
2. Crop your desired photo into the size specified on the right, and then insert it into the photo speed dial compartment. Then, insert the photo speed dial compartment cover back to the compartment.

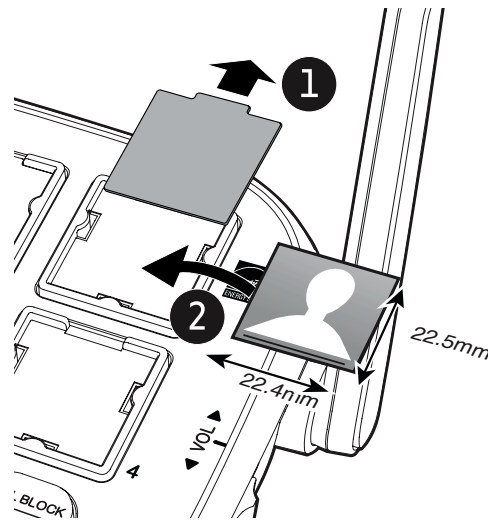

LCD language

You can select your handset's display language (English, French or Spanish).

1



MENU
SELECT

Press **MENU** when the handset is not in use.

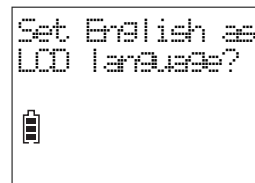
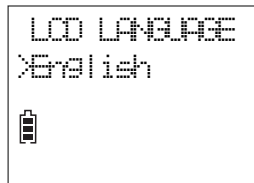
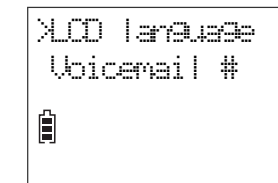
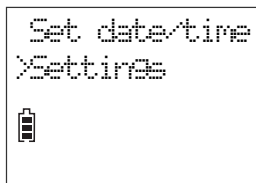

2



MENU
SELECT

Scroll to **Settings**, and then press **SELECT**.

3



MENU
SELECT

Press **SELECT** to select **LCD language**.

4



MENU
SELECT

Scroll to highlight **English, Français** or **Español**, and then press **SELECT**.

5



MENU
SELECT

Press **SELECT** to confirm.



Setup

Talking digits

You can choose whether the digits are to be announced whenever you press the number keys.

1



Press **MENU** when the handset is not in use.

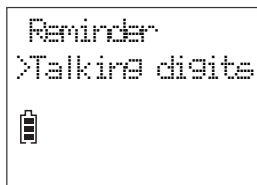

2



Scroll to **Talking digits**,
and then press **SELECT**.



3



Scroll to select **On** or **Off**,
and then press **SELECT**.

Key tone

The cordless handset is set to beep with each key press. You can adjust the key tone volume or turn it off. If you turn off the key tone, there are no beeps when you press keys.

1



MENU
SELECT

Press **MENU** when the handset is not in use.

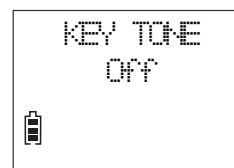
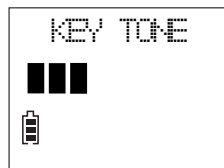
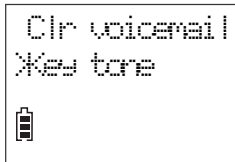
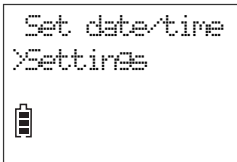

2



MENU
SELECT

Scroll to **Settings**,
and then press
SELECT.

3



MENU
SELECT

Scroll to **Key tone**,
and then press
SELECT.

4



Scroll to select the
desired volume or
select **OFF**.

5



MENU
SELECT

Press **SELECT** to
confirm.



Setup

Caller ID announce on/off

The caller ID announce feature lets you know who's calling without having to look at the display. When you have an incoming call, the handset and/or base speaks "Call from..." and the name of the caller based on the phonebook or caller ID information. The default setting is **On**.

NOTE

- To use the caller ID announce feature, you must subscribe to caller ID service from your **telephone service provider**.

1 **MENU SELECT** Press **MENU** when the handset is not in use.

2 **MENU SELECT** Scroll to **Caller ID annc**, and then press **SELECT**.

3 **MENU SELECT** Scroll to select **On** or **Off**, and then press **SELECT**.

The diagram illustrates the menu navigation process. On the left, a screen shows 'Talking digits' and 'XCaller ID annc' with a battery icon. On the right, a screen shows 'CALLER ID ANNC' and 'XOn' with a battery icon. Each screen is accompanied by 'CALL BLOCK' and speaker icons.

Use caller ID to automatically set date and time

If you subscribe to caller ID service, you can choose to set the date and time for each incoming call by the caller ID information automatically. The default setting is **On**.

1

MENU
SELECT

Press **MENU** when the handset is not in use.

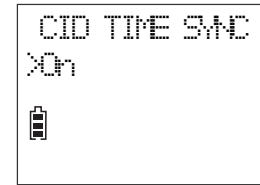
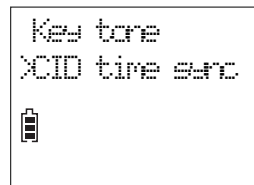
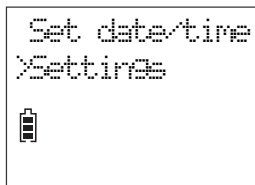

2

MENU
SELECT

Scroll to **Settings**, and then press **SELECT**.

3

MENU
SELECT

Scroll to **CID time sync**, and then press **SELECT**.

4

MENU
SELECT

Scroll to **On** or **Off**, and then press **SELECT**.



Setup

Vicemail number

If you subscribe to a voicemail service offered by your **telephone service provider**, you can save your voicemail number to  for quick access.



1



Press and hold 1 when the handset is not in use.

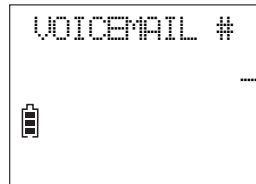

2



Enter the voicemail access number provided by your telephone service provider (up to 30 digits).

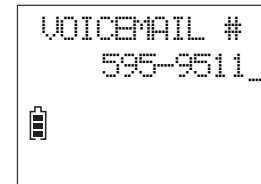

3



Press **SELECT**.

To retrieve voicemails from your telephone service provider:

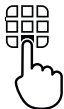

Press and hold 1.

Clear voicemail indicator

Use this feature when the telephone indicates that there is new voicemail but there are none. This feature only turns off the indicators, **New voicemail** and . It does not delete your voicemail messages. As long as you have new voicemail messages, your telephone service provider continues to send the signal to turn on the indicators.

1

 MENU
SELECT

Press **MENU** when the handset is not in use.

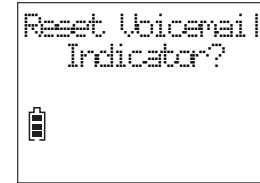
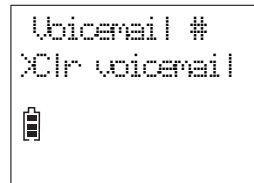
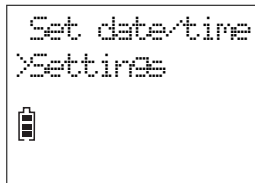

2

 MENU
SELECT

Scroll to **Settings**, and then press **SELECT**.

3

 MENU
SELECT

Scroll to **Clr voicemail**, and then press **SELECT**.

4

 MENU
SELECT



Press **SELECT** to confirm.











Setup

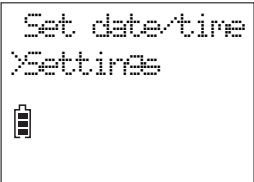

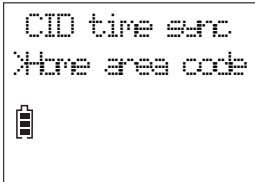
Home area code

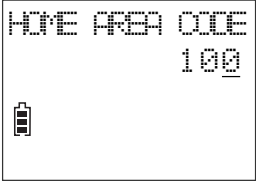

You can program your home area code so that when you receive or dial a call within your local area, only seven digits are shown or dialed, and the telephone number is automatically stored without the area code in the caller ID log.



1   Press **MENU** when the handset is not in use.

2   Scroll to **Settings**, and then press **SELECT**.

3   Scroll to **Home area code**, and then press **SELECT**.

4   Enter a three-digit home area code.

5   Press **SELECT**.

Dial mode

The dial mode is preset to touch-tone dialing. If you have pulse (rotary) service, you need to change the dial mode to pulse dialing before using the telephone.

1



MENU
SELECT

Press **MENU** when the handset is not in use.



Set date/time
>Settings
[Battery icon]

2



MENU
SELECT

Scroll to **Settings**, and then press **SELECT**.



Home area code
>Dial mode
[Battery icon]

3



MENU
SELECT

Scroll to **Dial mode**, and then press **SELECT**.



DIAL MODE
>Touch-tone
[Battery icon]

4



MENU
SELECT



Scroll to select **Touch-tone** or **Pulse**, and then press **SELECT**.









Setup



Alarm reminder and melody



You can set alarm reminders that remind you at specific times, once, daily, or at weekdays or weekends.



1   Press **MENU** when the handset is not in use.



   Set 505
>Reminder

   REMINDER
>Reminder 1

   REMINDER 1
>On/Off

2   Scroll to **Reminder**, and then press **SELECT**.

3   Scroll to select a reminder from **Reminder 1** to **Reminder 10**, and then press **SELECT**.

4   Press **SELECT** to select **On/Off**.

Alarm reminder and melody

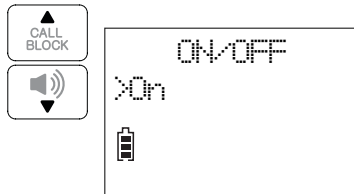

Scroll to **On** and then press **SELECT**.

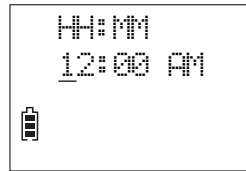

Enter the hour (**HH**) and minute (**MM**). Then, press any number key to change between **AM** and **PM**.

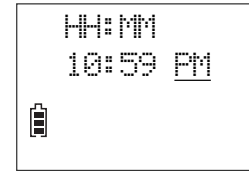

Press **SELECT**.



Scroll to select one of the frequency options, and then press **SELECT**.

- **Once;**
- **Daily;**
- **Mon. to Fri.;** or
- **Sat. to Sun.**

NOTES



- When the set reminder alarm time is due, the alarm will not ring if the telephone is in use.
- The cordless handset rings for 30 seconds when the alarm time is due.
- Press any key on the handset to stop the alarm when ringing.









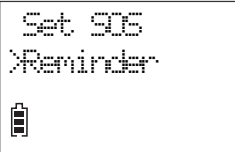

Setup

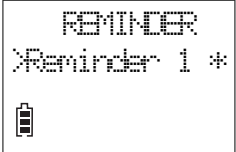

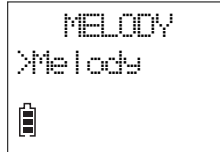
Alarm reminder and melody



You can also select the alarm reminder melody.



①   Press **MENU** when the handset is not in use.

②   Scroll to **Reminder**, and then press **SELECT**.

③   Scroll to select the desired reminder, and then press **SELECT**.

④   Scroll to **Melody**, and then press **SELECT**.

⑤   Scroll to the desired melody, and then press **SELECT**.

NOTE

- A reminder you have previously set up is added with an asterisk (*) after the name, for example, **Reminder 1 ***.



Operate

Display

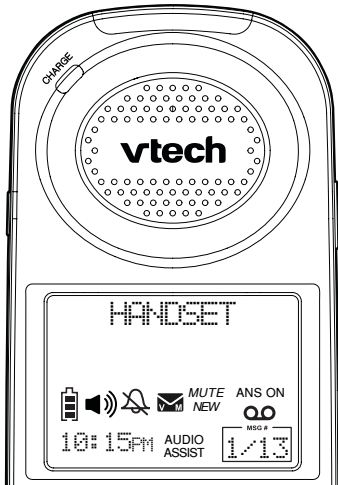

Audio Assist® is a registered trademark of Advanced Amercian Telephones.

	The battery is low and needs charging.
	The battery is charging.
	The battery is fully charged.
	The handset speakerphone is in use.
	Handset ringer is off.
	New voicemail received from your telephone service provider.
<i>MUTE</i>	The handset microphone is muted.
<i>NEW</i>	There are new caller ID log entries.
<i>ANS ON</i>	Answering system is on.
	There are new messages in the answering system.
	Number of new/old messages recorded.
AUDIO ASSIST	The handset Audio Assist® feature is on.



Operate

Make a call

On the cordless handset:



Press **TALK** or  on the handset.

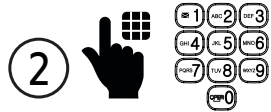

Dial the phone number.

Answer a call

On the cordless handset:



Press **TALK**,  or any dialing keys on the handset.

----- OR -----

On the telephone base:

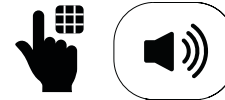

Press  on the telephone base.

End a call

On the cordless handset:



Press **OFF** on the handset.

-OR-

Place the handset in the charging cradle.

- If you are using the telephone base speakerphone, press  on the telephone base to end the call.

Speakerphone

On the cordless handset:



----- OR -----

On the telephone base:

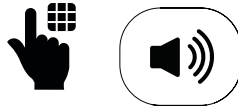

Volume

Handset

Telephone base

Down Up

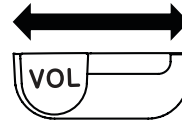

Down Up



Slide the **VOL** control on the cordless handset or on the telephone base:

- to adjust the speaker volume level when on a call; or
- to adjust the ringer volume when the telephone is ringing.

⚠ CAUTION

- For hearing protection, do not put the cordless handset near your ear when the telephone is ringing. Loud ringer sound may damage your hearing. Adjust the volume to lower the ringer sound if you find it too loud.





Operate

Make SOS emergency call

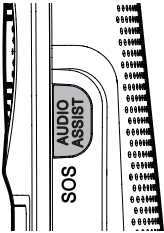



Press and hold **AUDIO ASSIST/SOS** on the cordless handset for 3 seconds. The telephone base announces, "Emergency mode is activated" and pages all registered devices. All devices ring an alert tone, and after 20 seconds, the telephone starts calling the preset SOS numbers.

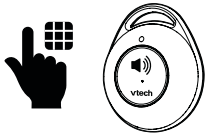

- If you disable internal SOS alert (page 16), the telephone calls the preset SOS numbers in sequence directly when you press and hold **AUDIO ASSIST/SOS**. See page 13 for details.

OR



- If you have purchased and registered a Wearable home SOS pendant (**SN7022**), press the dial key  on the SOS pendant to make SOS calls.

You can cancel SOS emergency call at any time:

- Press **TALK** or **CANCEL** on the handset; or
- Press and hold **AUDIO ASSIST/SOS** on the handset; or
- Press  on the telephone base; or
- Press the **CANCEL** key on the back of the SOS pendant.



"This is an emergency call. Please press any number key to start the conversation."

NOTES

- When the emergency call is answered, the telephone plays the SOS message (see page 17) to the call receiver, asking the receiver to respond by pressing a number key on his/her phone.
- After the call receiver presses a number key, you can then start a conversation with the call receiver.
- The **SOS**  button on the cordless handset functions as Audio Assist button when on a call or listening to a message or announcement.

Temporary ringer silencing

When the telephone is ringing, you can temporarily silence the ringer without disconnecting the call. The next call rings normally at the preset volume.

When the telephone is ringing:



MUTE
DELETE

- OR -



Press **MUTE** or **CANCEL** on the handset.

Call waiting

When you subscribe to call waiting service from your **telephone service provider**, you hear an alert tone if there is an incoming call while you are already on a call.



When on a call using the cordless handset.



- OR -



When on a call using the telephone base speakerphone.



- Press **FLASH** on the handset or telephone base to put the current call on hold and take the new call.
- Press **FLASH** at any time to switch back and forth between calls.



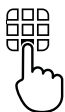

Operate

Redial

The last 10 numbers dialed (up to 30 digits) are stored in the cordless handset.

1  

Press and hold **REDIAL**, and then press ▼ or ▲ to browse the redial entries when the handset is not in use.

2  

To redial, press **TALK** on the handset.

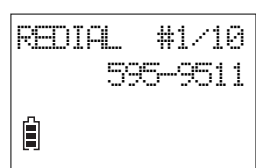

Photo/memory speed dial

If you have set any of the four direct memory speed dial numbers, you can press a photo speed dial key on the telephone base, or a directory memory key on the handset to quickly dial the preset number.

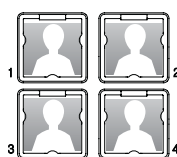

The telephone base and the cordless handset share the four direct memory speed dial numbers.

For details on setting photo/memory speed dial, see page 19.

Press a photo speed dial key on the telephone base to call.

----- OR -----

Press **M1**, **M2**, **M3** or **M4** on the handset to call.

Temporary tone dialing

If you have pulse (rotary) service only, you can switch from pulse to touch-tone dialing temporarily during a call. This is useful if you need to send touch-tone signals to access your telephone banking or long distance services.



When on a call, press **TONE*** on the handset.



Enter the number you wish to dial. The telephone sends touch-tone signals. It automatically returns to pulse dialing mode after you end the call.

Audio Assist®

The **Audio Assist** feature enhances the clarity and loudness of your caller's voice on the cordless/corded handset earpiece when you are on a call, or listening to a message or an announcement.

Turn on/off Audio Assist:



When on a call or listening to a message or an announcement:

- Press **AUDIO ASSIST** on the handset to turn on.
- Press again to turn off.



Operate

Equalizer

The equalizer on the cordless handset enable you to change the quality of the audio for both handset earpiece and speakerphone to best suit your hearing. The default setting is **Natural**.

Change the equalizer setting:

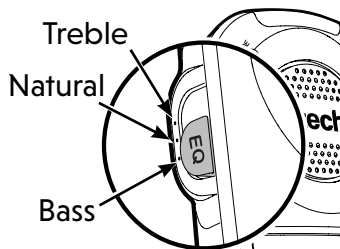

When on a call:

- Slide the **EQ** button to toggle among **Treble**, **Natural** and **Bass**.

Find handset

To find your misplaced cordless handset, press **PAGE** on the telephone base to make intercom paging to the handset.

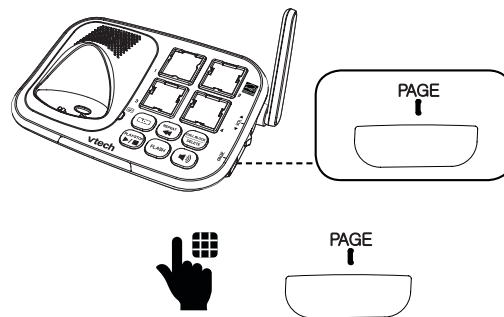

If you have two or more handsets, the telephone makes intercom paging to all handsets.

To stop the paging tone:

- Press **TALK** or  to answer the intercom call with the handset; or
- Press **PAGE** on the telephone base.

Join a call in progress

When you are already on an outside call, the telephone base can join the call using the speakphone. If you are on an outside call using the telephone base speakphone, then the handset can join the outside call.

To join a call with the cordless handset:



- OR -



Press **TALK** or  on the handset.

To join a call with the telephone base:



To exit the call:

- Press **OFF** or place the handset in the telephone base; or
- Press  on the telephone base.



Operate

Intercom

You can use the intercom feature for conversations between the telephone base and the cordless handset. If you have two or more cordless handsets, you can make intercom calls from the telephone base to all cordless handsets, or from one handset to another or to the telephone base.

Make intercom call using the cordless handset:

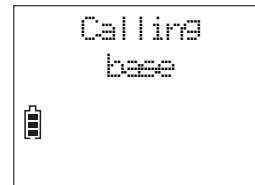
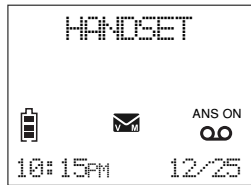

Press **MENU** when the handset is not in use.



Scroll to **Intercom**, and then press **SELECT**.

NOTE

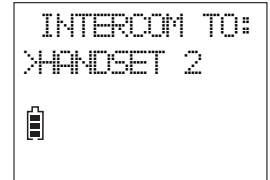

- If you have other registered devices or have two or more handsets, choose the device to call.

Make intercom call using the telephone base:

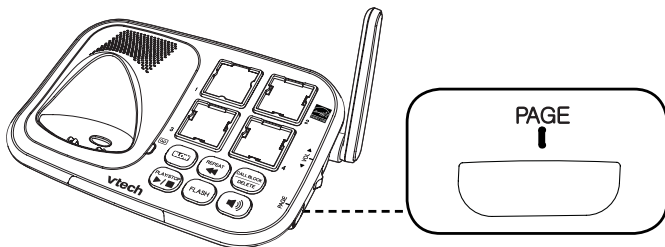



PAGE



Press **PAGE** when the telephone is not in use.

NOTES

- To answer the intercom call on the destination devices:
 - On a cordless handset, press **TALK** or .
 - On the telephone base, press .
- To cancel an intercom call:
 - When using the cordless handset, press **OFF**.
 - When using the telephone base, press **PAGE**.



Operate

Call transfer using Intercom

Use the intercom feature to transfer an outside call from the cordless handset to the telephone base. You can also share an outside call with the telephone base.

1



When on a call with your cordless handset, press **MENU**.



2



Press **SELECT** to select **Intercom**.

When the destination device picks up, the outside call is put on hold. Then, you have the following options:

- Transfer the call;
- Share the call; or
- End the call.

Transfer call:

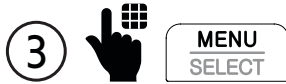

Press **MENU**.

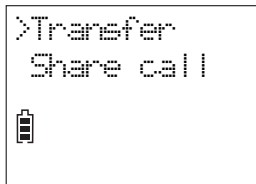

Press **SELECT** to select **Transfer**. The call is transferred to the destination device.

Share call:

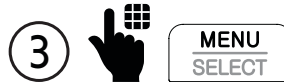

Press **MENU**.

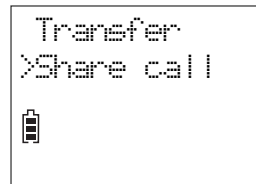

Scroll to **Share call**, and then press **SELECT** to let the destination device join you on the outside call in a three-way conversation.

End call:



Press **TALK**.

OR
Press **TALK** to end the intercom call and continue the outside call with your handset.



Phonebook

The phonebook can store up to 50 entries. Each entry may consist of a telephone number with up to 30 digits, and a name with up to 15 characters.

Add a phonebook entry



Enter the phone number when the handset is not in use.

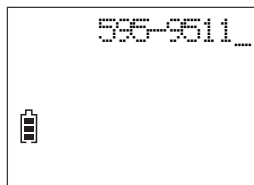

Press **SELECT**.

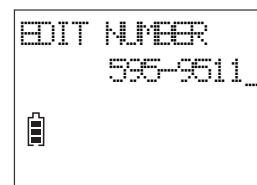

Press **SELECT** again.

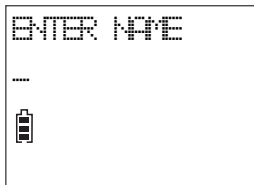

Enter the name

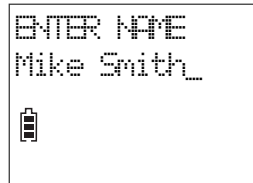

Press **SELECT**.

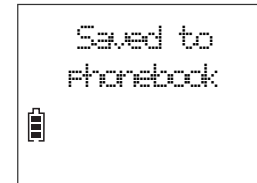

- OR -

1. Press **MENU** on the cordless handset when the telephone is not in use.
2. Scroll to **Phonebook**, and then press **SELECT**.
3. Scroll to **Add contact**, and then press **SELECT**.
4. Enter the phone number, and then press **SELECT**.
5. Enter the name, and then press **SELECT**.



Phonebook

Review phonebook entry

1



Press **MENU** when the handset is not in use.

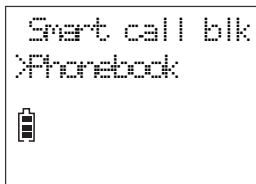

2



Scroll to **Phonebook**, and then press **SELECT**.

3



Press **SELECT** to select **Review**.

4



Scroll to browse through the entries.

Dial a phonebook entry

Review the phonebook entries, and when your desired entry shows on the handset screen:

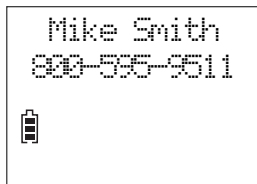

Press **TALK** on the handset.

Delete a phonebook entry

Review the phonebook entries, and when your desired entry shows on the handset screen:

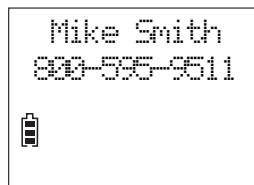

1



Press **DELETE**.

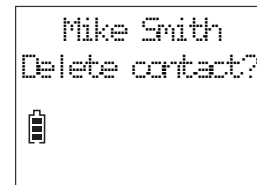

2



Press **SELECT** to delete.



Phonebook

Save a redial entry to the phonebook

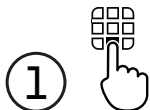

Press and hold **REDIAL** when the cordless handset is not in use.

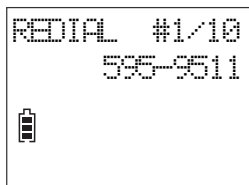

Scroll to browse through the redial list. When your desired entry displays, press **SELECT**.



Edit the phone number if needed, and then press **SELECT**.

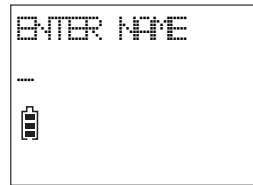

Enter the name.



Press **SELECT** to save.

Edit a phonebook entry

Review the phonebook entries, and when your desired entry shows on the handset screen:



Press **SELECT**.

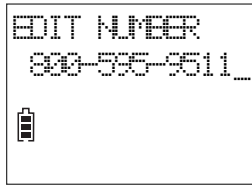

Edit the number.

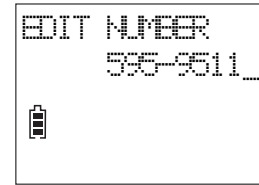

Press **SELECT**.

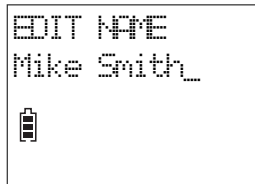

Edit the name.

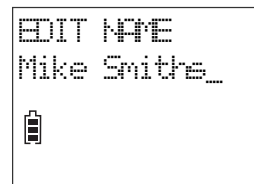

Press **SELECT** to save.







Caller ID



If you subscribe to caller ID service, information about each caller appears after the first or second ring.



The caller ID log stores up to 50 entries. Each entry has up to 24 digits for the phone number and 15 characters for the name.

Review caller ID log entry

1   Press **MENU** when the cordless handset is not in use.

2   Scroll to **Caller ID log**, and then press **SELECT**.

3   Press **SELECT** to select **Review**.

4    Scroll to browse through the entries.

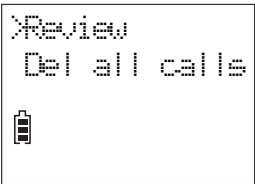
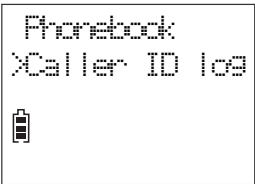

Save a caller ID log entry to the phonebook

When your desired caller ID log entry shows on the handset screen:



1



Press **SELECT**.



2



Press **SELECT**.

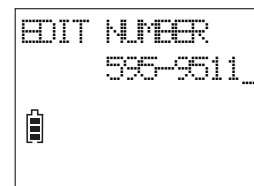

3



Edit the number if needed.

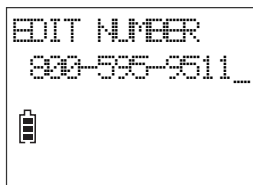

4



Press **SELECT**.

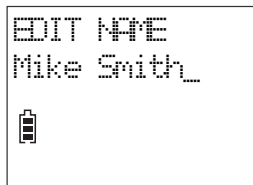

5



Edit the name if needed.



6



Press **SELECT** to save.



Caller ID

Dial a caller ID log entry

Review the caller ID log entries, and when your desired entry shows on the handset screen:



Press **TALK** on the handset.

Delete a caller ID log entry

Review the caller ID log entries, and when your desired entry shows on the handset screen:



Press **DELETE** on the handset.



Smart call blocker*

If you have subscribed to caller ID service, then you can use the Smart call blocker feature to screen incoming calls.

Smart call blocker is on, once you install your telephone. It allows all incoming calls to get through and ring by default. You can change the Smart call blocker settings to screen incoming calls.

With call screening active, Smart call blocker screens and filters all incoming calls from numbers or names that are not yet saved in your directory, allow list, block list, or star name list. You can easily add incoming phone numbers to your allow list and block list. This allows you to build up your lists of allowed and blocked numbers, and Smart call blocker will know how to deal with these calls when they come in again.

Read the **Introducing Smart call blocker** leaflet provided in your package to learn how to set up your Smart call blocker.

* Includes licenced Qaltel™ technology.
Qaltel™ is a trademark of Truecall Group Limited.



Smart call blocker

Call categories

Calls are classified into four categories. Smart call blocker handles the calls in the following ways:

CALL CATEGORY	CALL CONTROL
Welcome calls <ul style="list-style-type: none">• Numbers saved in allow list.• Numbers saved in phonebook.• Numbers not found in block list.• Names saved in star name list.	Allow <p>The telephone rings when there is an incoming call with number saved in your allow list or phonebook, but not in your block list. Robocalls with caller names saved in your star name list will also ring.</p>
Unwelcome calls <ul style="list-style-type: none">• Numbers saved in block list.	Block <p>The telephone does not ring when there is an incoming call with number saved in your block list, and the call will be rejected.</p>

CALL CATEGORY	CALL CONTROL
<p>Calls without numbers</p> <ul style="list-style-type: none"> Numbers that are “out of area” or set to “Private”. <p>Uncategorized calls</p> <ul style="list-style-type: none"> With absent caller ID number. Numbers not found in phonebook. Numbers not found in allow list. Numbers not found in block list. Caller ID names not found in star name list. 	<p>Option 1: Screening with caller name</p> <p>If you have selected this option, the telephone plays the screening announcement, and then asks the caller to say his/her name before the call rings on your telephone. You will then hear the caller’s name announced if you have turned on the caller ID announce feature. Then, you can decide whether to accept or reject the call, or to forward the call to the answering system.</p> <p>Option 2: Screening without caller name</p> <p>If you have selected this option, the telephone plays the screening announcement, and then asks the caller to press the pound key (#) before the call rings on your telephone. You can then answer the call.</p> <p>Option 3: Allow (default settings)</p> <p>The telephone allows the calls to get through and ring. The caller’s number will not be saved to the allow list.</p> <p>Option 4: Answering system</p> <p>If you have selected this option, the telephone forwards the calls to the answering system without ringing.</p> <p>Option 5: Block</p> <p>If you have selected this option, the telephone rejects the calls with block announcement without ringing. The caller’s number will not be saved to the block list.</p>



Smart call blocker

Set Smart call blocker on/off

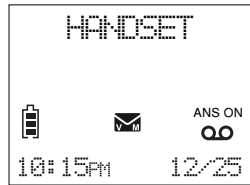

1



Press **CALL BLOCK** when the handset is not in use.



2



Press **SELECT** to select **SCB On/Off**.

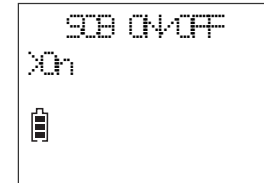

3







Scroll to **On** or **Off**, and then press **SELECT**.



Set welcome calls



Add allow list entry



Add numbers to the allow list that you want to allow their calls to get through to you. The allow list stores up to 200 numbers.

1   Press **CALL BLOCK** when the handset is not in use.



  
Block list
XAllow list

2   Scroll to **Allow list**, and then press **SELECT**.

  
Review
XAdd new entry

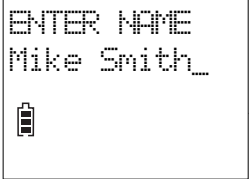
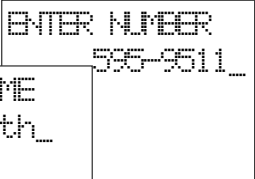
3   Scroll to **Add new entry**, and then press **SELECT**.

 
ENTER NAME
Mike Smith_
ENTER NUMBER
505-9511_

4    Enter the phone number and name, and then press **SELECT** to save.



Smart call blocker

Set welcome calls

Add star name list entry

Add names (up to 15 characters) of organizations like schools, medical offices, and pharmacies that use robocalls to communicate important information to you. Their calls will get through to you. The star name list stores up to 10 names.

1 **CALL BLOCK** Press **CALL BLOCK** when the handset is not in use.

2 **CALL BLOCK**

Allow list
Star name list

CALL BLOCK

MENU
SELECT

Scroll to **Star name list**, and then press **SELECT**.

3 **CALL BLOCK**

Review
Add new entry

CALL BLOCK

MENU
SELECT

Scroll to **Add new entry**, and then press **SELECT**.

4 **CALL BLOCK**

ENTER NAME
Bariver Eleven

CALL BLOCK

MENU
SELECT

Enter the name, and then press **SELECT** to save.

Set welcome calls

Save a caller ID log to the allow list

Review the caller ID log entries:

1. Press **MENU** when the handset is not in use.
2. Scroll to **Caller ID log**, and then press **SELECT**.
3. Press **SELECT** to select **Review**.

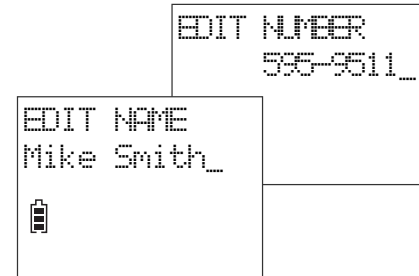

Browse through the entries.
When the desired entry
displays, press **SELECT**.



Scroll to **Allow list**, and
then press **SELECT**.



Edit the phone number and
name if needed, and then
press **SELECT** to save.



Smart call blocker

Set welcome calls

Save a caller ID log to the star name list

Review the caller ID log entries:

1. Press **MENU** when the handset is not in use.
2. Scroll to **Caller ID log**, and then press **SELECT**.
3. Press **SELECT** to select **Review**.

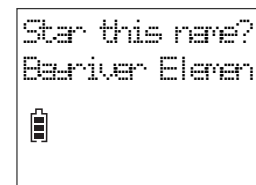
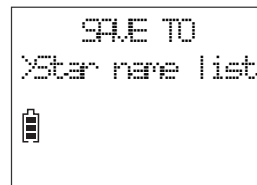

4



Browse through the entries.
When the desired entry
displays, press **SELECT**.

5



Scroll to **Star name list**,
and then press **SELECT**.

6







Press **SELECT** to save.



Set unwelcome calls



Add block list entry

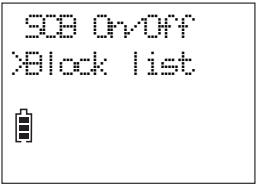

Add numbers to the block list that you want to block them from calling. The block list stores up to 1,000 entries.



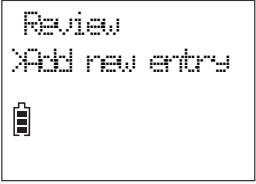

1   Press **CALL BLOCK** when the handset is not in use.



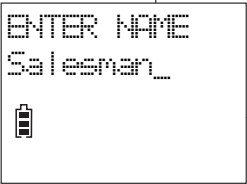

2   Scroll to **Block list**, and then press **SELECT**.

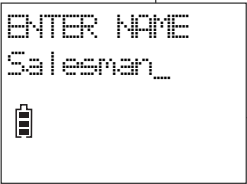
3   Scroll to **Add new entry**, and then press **SELECT**.

4    Enter the phone number and name, and then press **SELECT** to save.



Smart call blocker

Set unwelcome calls

Save a caller ID log to the block list

Review the caller ID log entries:

1. Press **MENU** when the handset is not in use.
2. Scroll to **Caller ID log**, and then press **SELECT**.
3. Press **SELECT** to select **Review**.

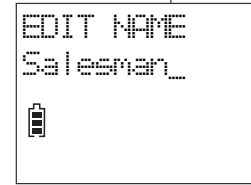
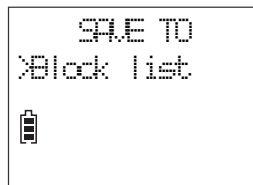

4



Browse through the entries.
When the desired entry displays, press **SELECT**.

5



Scroll to **Block list**, and then press **SELECT**.

6



Edit the phone number and name if needed, and then press **SELECT** to save.

Control calls without numbers

Use this setting to control "out of area" calls or calls with numbers that are set to "Private". You can choose to allow or reject these calls directly. You can also choose to screen them with or without learning the callers' names before you decide whether to answer or reject these calls. Moreover, you can forward these calls to the answering system.

1  **CALL BLOCK** Press **CALL BLOCK** when the handset is not in use.

2  **MENU SELECT**

Scroll to **Calls w/o num**, and then press **SELECT**.

3  **MENU SELECT**

Scroll to select **Screening**, **Allow**, **Answering sys** or **Block**, and then press **SELECT**.

4  **MENU SELECT**

If you select **Screening**, scroll to select **w/Caller name** or **w/o Caller name**, and then press **SELECT**.

CALL BLOCK

Star name list
XCalls w/o num





CALL BLOCK

CALLS W/O NUM
XScreening





CALL BLOCK

SCREENING
Xw/ Caller name



















Smart call blocker





Control uncategorized calls

Use this setting to control calls with numbers that are not in your phonebook, allow list or block list, or have no caller ID number display. You can choose to allow or reject these calls directly. You can also choose to screen them with or without learning the callers' names before you decide whether to answer or reject these calls. Moreover, you can forward these calls to the answering system.

1   Press **CALL BLOCK** when the handset is not in use.

2      Scroll to **Uncategorized**, and then press **SELECT**.

3      Scroll to select **Screening**, **Allow**, **Answering sys** or **Block**, and then press **SELECT**.

4      If you select **Screening**, scroll to select **w/Caller name** or **w/o Caller name**, and then press **SELECT** when done.

Screen calls without numbers

If Smart call blocker is on, and you have set to screen calls without numbers, the telephone will not ring when receiving calls without numbers. It plays the screening announcement to the caller and asks the caller to respond before putting the call through to you.

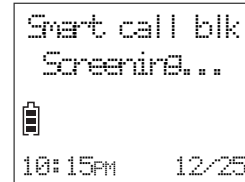

The telephone is playing the screening announcement to the caller.

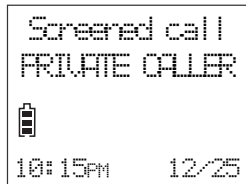

If you have selected **w/Caller name** to ask callers to say their names:

After you pick up the call, the telephone announces:

 *"To answer the call, press 1. To send this call to the answering system, press 4. To repeat these options, press *".*



After screening, the telephone rings. Press **TALK** or  to pick up the call.

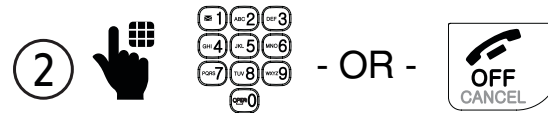

- Press **1** to answer the call;
- Press **4** to send it to the answering system; or
- Press **OFF** to hang up.



Smart call blocker

Screen uncategorized calls

If Smart call blocker is on, and you have set to screen uncategorized calls, the telephone will not ring when receiving these calls. It plays the screening announcement to the caller and asks the caller to respond before putting the call through to you.

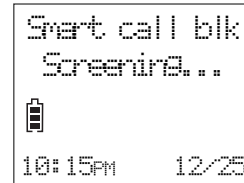

The telephone is playing the screening announcement to the caller.

If you have selected **w/Caller name** to ask callers to say their names:

After you pick up the call, the telephone announces:

"To answer the call, press 1. To answer and always allow this number, press 2. To block this number, press 3. To send this call to the answering system, press 4. To repeat these options, press *".

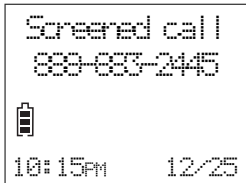

After screening, the telephone rings. Press **TALK** or to pick up the call.

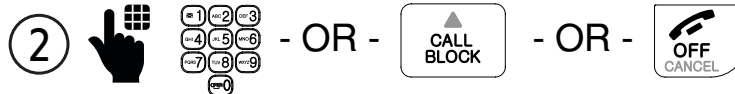

- Press **1** to answer the call;
- Press **2** to answer and always allow this number;
- Press **3** or **CALL BLOCK** to block the call; or
- Press **4** to send it to the answering system; or
- Press **OFF** to hang up.

Add a screened number to the allow list or block list

When the telephone announces the screening options after you pick up a screened call:

 "To answer the call, press 1. To answer and always allow this number, press 2. To block this number, press 3. To send this call to the answering system, press 4. To repeat these options, press *".

Add a screened number to the allow list



Press **2** to answer the call. The telephone will add the current number to the allow list.

Add a screened number to the block list



Press **3** or **CALL BLOCK** to block the call. The telephone will add the current number to the block list.

Option while on a call

When you are on a call and speaking to the caller, and you do not want to continue the call, you can end the call with block announcement and add the number to the block list.

1. During a call, press **CALL BLOCK**.
2. Press **SELECT** to end the call.

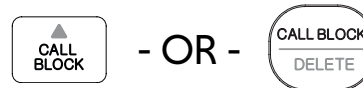



Answering system

About the built-in answering system and voicemail service



For message recording, your telephone has a built-in answering system, and it also supports voicemail service offered by your **telephone service provider** (subscription is required, and fee may apply).

Built-in answering system VS Voicemail service

	BUILT-IN ANSWERING SYSTEM	VOICEMAIL SERVICE
SUPPORTED BY	Telephone system	Telephone service provider
SUBSCRIPTION	No	Yes
FEES	No	May apply
ANSWER INCOMING CALLS	<ul style="list-style-type: none">• After 4 rings by default.• It can be changed via handset menu.	<ul style="list-style-type: none">• Usually after 2 rings.• It can be changed by contacting your telephone service provider.

BUILT-IN ANSWERING SYSTEM

VOICEMAIL SERVICE

STORAGE	Telephone base	Server or System
DISPLAY NEW MESSAGES	<ul style="list-style-type: none">• Handset - XX New messages	<ul style="list-style-type: none">• Handset -  and New voicemail
RETRIEVE MESSAGES	<ul style="list-style-type: none">• Press ►/■ on the telephone base; OR• Press MENU, and then select Play messages on the handset; OR• Access remotely with an access code.	<ul style="list-style-type: none">• <u>Press and hold</u>  1 on the dialpad, and enter an access number and/or passcode from your telephone service provider.



Answering system

Turn the built-in answering system on or off

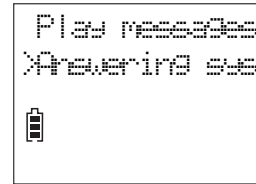
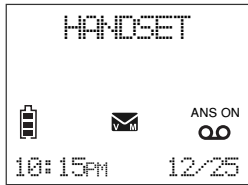

Press **MENU** when the handset is not in use.



Scroll to **Answering sys**, and then press **SELECT**.

Turn the built-in answering system on or off

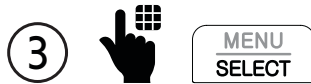
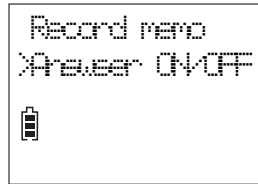

Scroll to **Answer ON/OFF**, and then press **SELECT**.

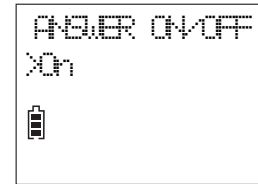

Scroll to **On** or **Off**, and then press **SELECT**.



Answering system

Set number of rings

You can set your answering system to answer calls at least two rings earlier than your voicemail service. For example, if your voicemail service answers after six rings, set your answering system to answer after four rings. Thus, if you are on a call, or if the answering system is busy recording a message and you receive another call, the second caller can leave a voicemail message.



Press **MENU** when the handset is not in use.

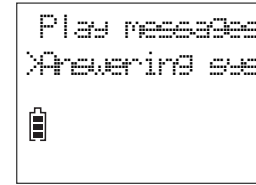

Scroll to **Answering sys**, and then press **SELECT**.

Set number of rings

3 Scroll to **Ans sys setup**, and then press **SELECT**.

4 Scroll to **# of rings**, and then press **SELECT**.

5 Select **6, 5, 4, 3, 2** or **Toll saver**, and then press **SELECT**.

NOTE

- If you select **Toll saver**, the answering system answers a call after two rings when you have new messages, and after four rings when there are no new messages. This feature allows you to check for new messages and avoid paying long distance charges when calling from out of your local area.



Answering system

Message playback

On the telephone base:



- OR -

On the cordless handset:

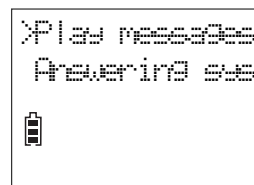
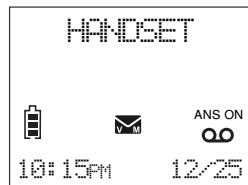

1



Press **MENU** when the handset is not in use.

2



Press **SELECT** to select **Play messages**.

☀ TIP

- While playing back a message on the telephone base, you can press  to reduce the playback speed.

Skip a message

If you are using the cordless handset to play messages, you can skip a message.

On the cordless handset:



Repeat the playing message

On the telephone base:



- OR -

On the cordless handset:





Answering system

Play the previous message

On the telephone base:



Press **REPEAT** twice.

----- OR -----

On the cordless handset:



Press **4** twice.

Delete a message

When message is playing:

On the telephone base:



- OR -

On the cordless handset:



Delete all messages

On the telephone base:

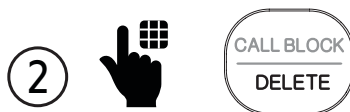
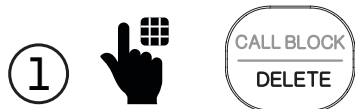

Press **CALL BLOCK/DELETE** twice.

On the cordless handset:

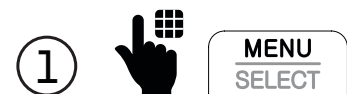

Press **MENU** when the handset is not in use.

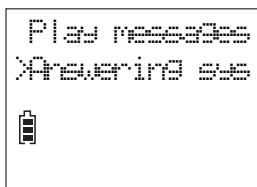

Scroll to **Answering sys**, then press **SELECT**.

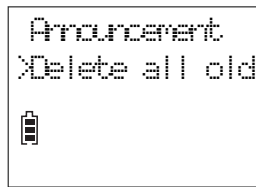

Scroll to **Delete all old**, then press **SELECT**.



Press **SELECT** again to confirm.



Answering system

Remote access

You can reach your answering system remotely by dialing your home telephone number from any touch-tone telephone. A two-digit security code is required. The preset code is **19**. You can set the code from **00** to **99**.

- ① To access your answering system remotely, dial your telephone number from any touch-tone telephone.
- ② When the system plays your answering system announcement, *"Hello. Please leave a message after the tone."*, enter the two-digit security code.
- ③ Enter one of the remote commands.

COMMAND	DESCRIPTION
1	Play all messages.
2	Play only new messages.
3	Delete the current message (during playback).
33	Delete all old messages.
4	Repeat the current message (during playback).
5	Stop.
*5	Hear a list of remote commands.
6	Skip to the next message (during playback).
*7	Record a new announcement.
8	End the call.
0	Turn the answering system on or off.

Set remote access code

You can set your own remote access code from **00** to **99**.

1



MENU
SELECT

Press **MENU** when the handset is not in use.

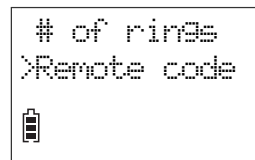
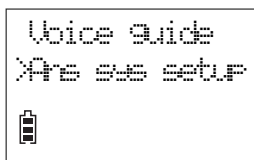
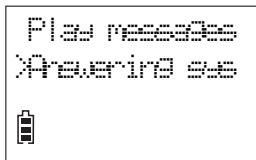

2



MENU
SELECT

Scroll to **Answering sys**, and then press **SELECT**.

3



MENU
SELECT

Scroll to **Ans sys setup**, and then press **SELECT**.

4



MENU
SELECT

Scroll to **Remote code**, and then press **SELECT**.

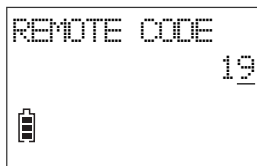

Enter a two-digit number.



Press **SELECT** to save.

5



6



MENU
SELECT



Additional devices

Add and register expansion handset

You can add new cordless handsets (**SN5107**, purchased separately) to expand your telephone system. Your telephone base supports a maximum of four cordless handsets. Additional handsets are assigned with numbers in sequential order.

Charge the new handset without interruption for at least 30 minutes before registering it to the telephone base. After charged, each expansion handset displays **To register HS, see manual**.

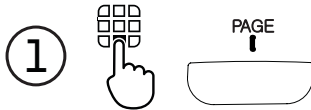
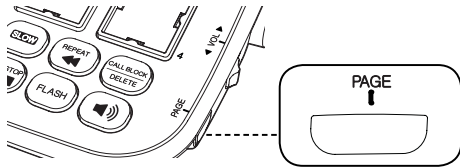

When the telephone is not in use, press and hold **PAGE** on the telephone base for about five seconds until the visual ringer indicator light turns on. Release **PAGE**.

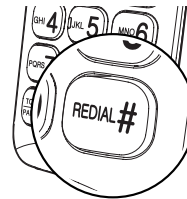

Press the pound (#) key on the handset to register.

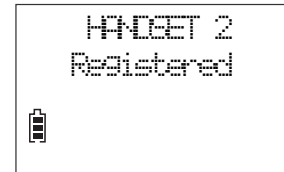
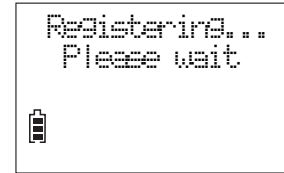

When the registration is successful, the handset displays **HANDSET X Registered**.

Add and register photo speed dial handset

You can add a new photo speed dial handset (**SN5307**, purchased separately) to your telephone system. The **SN5307** cordless photo speed dial handset lets you quickly dial one of the four preset numbers by just pressing the photo speed dial key.

If you have already set the direct memory speed dial keys **1**, **2**, **3** and **4** on the telephone base, the same numbers will be automatically set for the dial keys of your newly registered photo speed dial handset.

You can register a maximum of four cordless handsets.

You need to register your new photo speed dial handset to the telephone base before use.

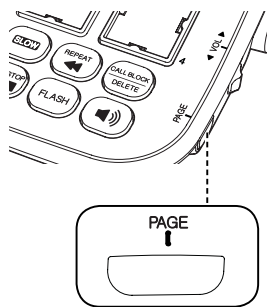

①

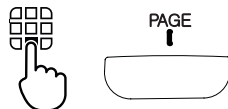

When the telephone is not in use, press and hold **PAGE** on the telephone base for about five seconds until the visual ringer indicator light turns on. Release **PAGE**.

②

Put the handset on its charger to begin registration. The handset **CHARGE** light alternates red and green quickly to indicate the registration is in progress.



For registration and detailed operations, read the user's manual of your new photo speed dial handset provided in your package.



Additional devices

Device setup

You can add VTech compatible Cordless audio doorbell, ULE Cordless extension ringer and ULE Wearable home SOS pendant (**SN7021**, **SN7014** and **SN7022**, all purchased separately) to your telephone system.

The Cordless audio doorbell (**SN7021**) helps you get notified at your telephone system upon visitors' arrival. When a visitor presses the Audio doorbell, both the base and the handset will play the chime tone, and you can then answer the doorbell call and talk to the visitor at your door with the handset or base. For operation instructions, refer to page 88 to page 99.

VTech compatible ULE devices



The ULE Cordless extension ringer (**SN7014**) works as an extra ringer and/or flashing lights in addition to your handset and base. It lets you hear and see more clearly when there is an incoming call.

The ULE Wearable home SOS pendant (**SN7022**) function as same as the SOS button of your cordless handset. It acts as a handy pendant to let you quickly call the preset SOS numbers for help in an emergency, even when your telephone is beyond your reach. For detailed setups and operations, refer to **Set SOS emergency call** section on page 13 to page 18, and **Make SOS emergency call** section on page 38.

NOTE

- You can add a maximum of two Cordless audio doorbells and 30 compatible ULE devices to your telephone base.

NOTES

- You need to register your newly purchased devices to the telephone base before use.
- Make sure the new devices are powered on with batteries or with AC power before registering them to the telephone base.

Add and register a new device

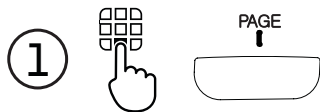
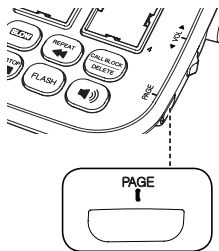

When the telephone is not in use, press and hold **PAGE** on the telephone base for about five seconds until the visual ringer indicator light turns on. Release **PAGE**.

2 Extension ringer



Press and hold the pair button  on the right side of the extension ringer until the green LED light on the front flashes, then release the button. When registration is successful, the green LED light becomes steady on, and then the base beeps once.

Audio doorbell

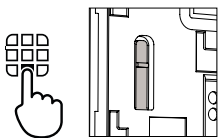

Press and hold the pair button on the back of the audio doorbell until the chime button LED light flashes, then release the pair button. When registration is successful, the chime button LED light becomes steady on, and then the base beeps once.

SOS pendant

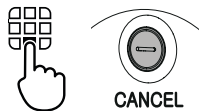

Press and hold **CANCEL** on the back of the SOS pendant until the LED light on the front flashes, then release the button. When registration is successful, the LED light turns off, and then the base beeps once.



Additional devices

Audio doorbell

(Model **SN7021** , purchased separately)

If you have purchased and registered an Cordless audio doorbell (**SN7021**) to the telephone base, the **Doorbell** sub-menu option appears in the **Set device** menu of the cordless handset. You can set up your Cordless audio doorbell, for example, set the chime volume and tone, and divert doorbell calls to a preset number. You can also record doorbell calls.

Set chime volume

1 Press **MENU SELECT** on the handset when it is not in use.

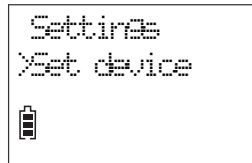

2



Scroll to **Set device**, and then press **SELECT**.

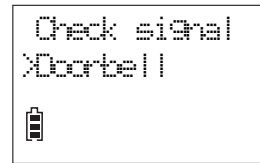

3



Scroll to **Doorbell**, and then press **SELECT**.



4



MENU
SELECT

Press **SELECT** to
select **Chime**.



5



MENU
SELECT

Press **SELECT** again to
select **Chime volume**.

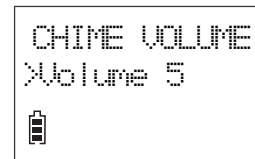

6



MENU
SELECT

Scroll to select from
Volume 1 to **Volume 5**,
or select **Off**, and then
press **SELECT**.



Additional devices

Audio doorbell

(Model **SN7021** , purchased separately)

Set chime tone

1



Press **MENU** when the handset is not in use.

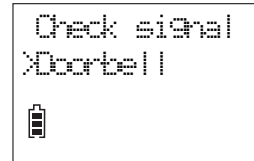
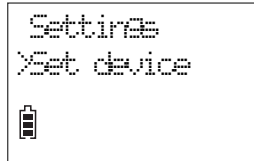

2



Scroll to **Set device**, and then press **SELECT**.

3



Scroll to **Doorbell**, and then press **SELECT**.

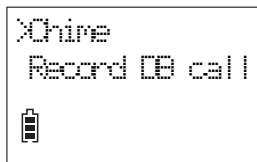

4



MENU
SELECT

Press **SELECT** to
select **Chime**.

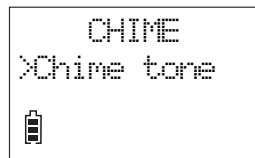

5



MENU
SELECT

Scroll to **Chime tone**
and then press **SELECT**.

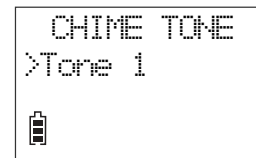

6



MENU
SELECT

Scroll to select from
Tone 1 to **Tone 5**, or
select **Off**, and then
press **SELECT**.



Additional devices

Audio doorbell (Model **SN7021** , purchased separately)

When a visitor presses your audio doorbell, all your devices chime and the handset screen shows **Doorbell X is ringing**.

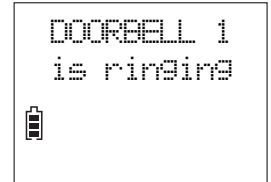

Answer a doorbell call

Using a cordless handset:



Press **TALK** on a cordless handset to answer.

Using the telephone base:

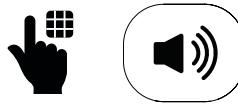

Press  on the telephone base.

Decline a doorbell call

Using a cordless handset:



When the chime tone is ringing, press **OFF** on the handset.

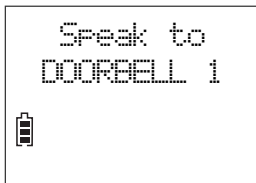

NOTE

- After you press **TALK** on the cordless handset to answer the doorbell, the handset screen displays **Speak to DOORBELL X**. You can then talk with the visitor at your door.

Record doorbell call

You can record conversations between you at the telephone and the visitor at your door. Your telephone is set to record all doorbell calls by default. You can disable the setting.

1



Press **MENU** on the handset when it is not in use.

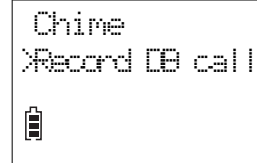
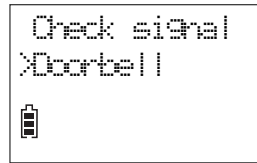
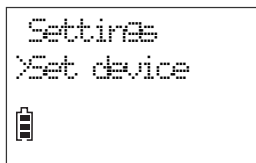

2



Scroll to **Set device**, and then press **SELECT**.

3



Scroll to **Doorbell**, and then press **SELECT**.

4



Scroll to **Record DB call** and press **SELECT**. Then, scroll to **On** or **Off**, and press **SELECT**.

NOTE

- Recorded doorbell calls are stored as voice messages. See **Message playback** section on page 78 to retrieve your doorbell call conversations.



Additional devices

Audio doorbell (Model **SN7021** , purchased separately)

You can divert all doorbell calls to a preset external number, or decline a doorbell call and forward the doorbell call to the preset external number.

Set call divert number

1



MENU
SELECT

Press **MENU** on the handset when it is not in use.

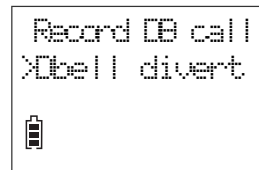
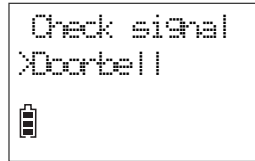
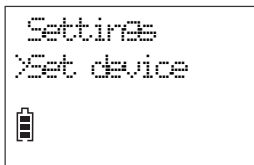

2



MENU
SELECT

Scroll to **Set device**, and then press **SELECT**.

3



MENU
SELECT

Scroll to **Doorbell**, and then press **SELECT**.

4



MENU
SELECT

Scroll to **Dbell divert**, and then press **SELECT**.

NOTE

When a visitor presses the doorbell and the doorbell call is diverted to the preset number, the call receiver of the preset number hears the message *"This is a diverted call from doorbell. Please press any number key to start the conversation."* Your telephone is set to record all doorbell call conversations by default. You can disable the setting. See **Record doorbell call** on page 93.

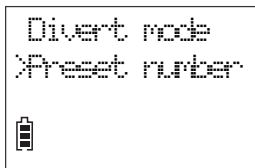

Scroll to **Preset number**, and then press **SELECT**.

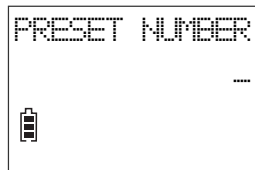

Enter the destination number.

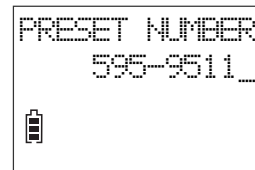

Press **SELECT** to save.



Additional devices

Audio doorbell (Model **SN7021**, purchased separately)

You can set your audio doorbell to divert all doorbell calls to the preset external number when visitors press the doorbell.

Set auto call divert to preset number

1



Press **MENU** on the handset when it is not in use.

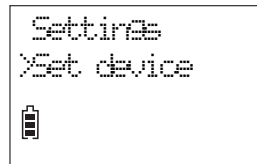

2



Scroll to **Set device**, and then press **SELECT**.

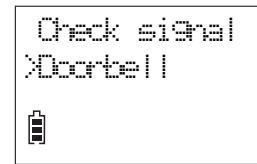

3



Scroll to **Doorbell**, and then press **SELECT**.

NOTE

To cancel all call divers to the preset number:

1. Repeat from step 1 to step 5.
2. Then, at step 6, scroll to **Off** and then press **SELECT**.



Record call
>bell divert



4



MENU
SELECT

Scroll to **Dbell divert**, and then press **SELECT**.

>Divert mode
Preset number



5



MENU
SELECT

Press **SELECT** to select **Divert mode**.



DIVERT MODE
>Auto divert



6



MENU
SELECT

Scroll to **Auto divert**, and then press **SELECT**.



Additional devices

Audio doorbell (Model **SN7021** , purchased separately)

You can also set up call divert to the preset number, only when you press **OFF** on your handset to decline the doorbell call.

Set declined call divert to preset number

1



Press **MENU** on the handset when it is not in use.

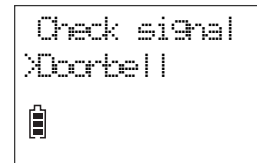
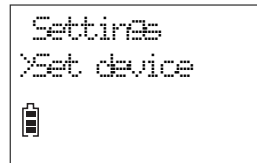

2



Scroll to **Set device**, and then press **SELECT**.

3



Scroll to **Doorbell**, and then press **SELECT**.

NOTE

To cancel all call diverts to the preset number:

1. Repeat from step 1 to step 5.
2. Then, at step 6, scroll to **Off** and then press **SELECT**.

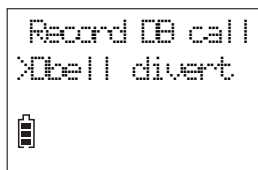

Scroll to **Dbell divert**, and then press **SELECT**.

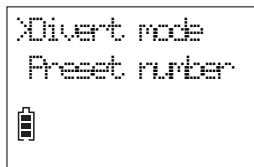

Press **SELECT** to select **Divert mode**.

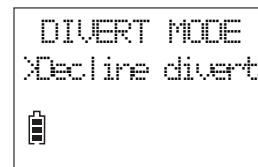

Scroll to **Decline divert**, and then press **SELECT**.



Additional devices

Test device signal strength

You can check the signal strength of your devices (**SN7014/SN7021/SN7022**, all purchased separately), for example, before mounting it. Follow the instructions below to check the signal strength between the device and the telephone base. For Extension ringer (**SN7014**) and Audio doorbell (**SN7021**), make sure you mount them in a location where the signal strength is good.

1



MENU
SELECT

Press **MENU** on the handset when it is not in use.

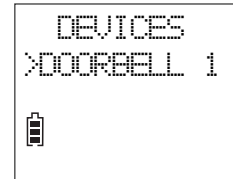
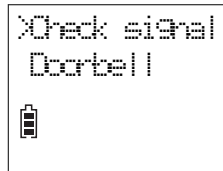
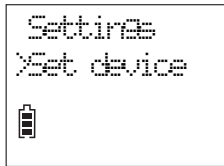

2



MENU
SELECT

Scroll to **Set device**, and then press **SELECT**.

3



MENU
SELECT

Press **SELECT** to select **Check signal**.

4



MENU
SELECT

Scroll to select the desired device, and then press **SELECT**.

5 When the handset displays **Awaiting signal**:

Audio doorbell

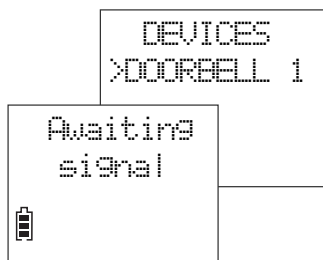

Press the chime button on the audio doorbell.

SOS pendant

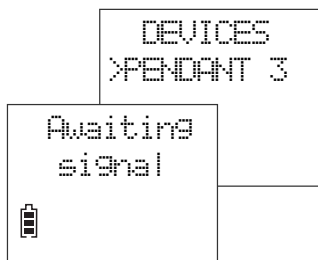

Press the **CANCEL** button on the audio doorbell.

- OR -

Extension ringer

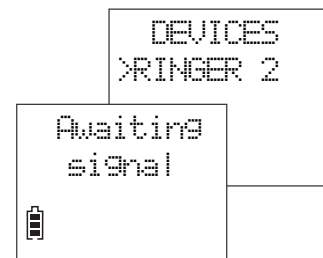

NOTE

For Extension ringer, the telephone checks the signal automatically after selecting **RINGER X** on the handset.



TIP

When the handset displays **Good signal**, press **SELECT** to confirm.

- If the handset displays **No signal** or **Weak signal**, check your device and make sure it is powered on, or select another location nearer to the telephone base.



Additional devices

Device monitoring

If there are additional devices registered to the telephone base, the names of the registered devices appear in the **Devices** menu of the cordless handset.

You can view the current status of each of the registered devices and check whether they are active, inactive, or with low battery.

View device status

1 Press **MENU SELECT** on the handset when it is not in use.

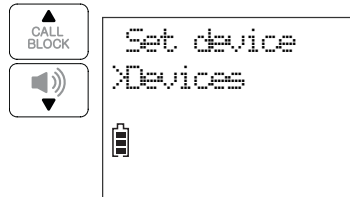

2  **MENU SELECT**

Scroll to **Devices**, and then press **SELECT**.

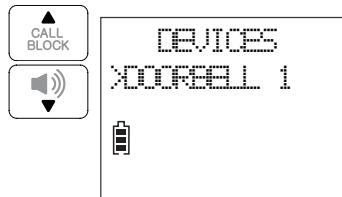

3  **MENU SELECT**

Scroll to the desired device, and press **SELECT**.

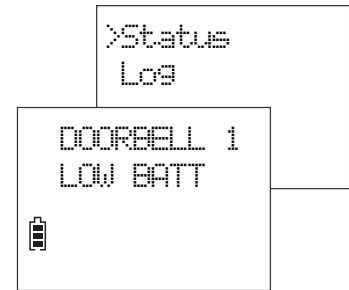

4  **MENU SELECT**

Press **SELECT** to select **Status** and view the current status of the device.

Limited warranty

What does this limited warranty cover?

The manufacturer of this VTech Product warrants to the holder of a valid proof of purchase ("Consumer" or "you") that the Product and all accessories provided in the sales package ("Product") are free from defects in material and workmanship, pursuant to the following terms and conditions, when installed and used normally and in accordance with the Product operating instructions. This limited warranty extends only to the Consumer for Products purchased and used in the United States of America and Canada.

What will VTech do if the Product is not free from defects in materials and workmanship during the limited warranty period ("Materially Defective Product")?

During the limited warranty period, VTech's authorized service representative will repair or replace at VTech's option, without charge, a Materially Defective Product. If we repair the Product, we may use new or refurbished replacement parts. If we choose to replace the Product, we may replace it with a new or refurbished Product of the same or similar design. We will retain defective parts, modules, or equipment. Repair or replacement of the Product, at VTech's option, is your exclusive remedy. VTech will return the repaired or replacement Products to you in working condition. You should expect the repair or replacement to take approximately 30 days.

How long is the limited warranty period?

The limited warranty period for the Product extends for ONE (1) YEAR from the date of purchase. If VTech repairs or replaces a Materially Defective Product under the terms of this limited warranty, this limited warranty also applies to the repaired or replacement

Product for a period of either (a) 90 days from the date the repaired or replacement Product is shipped to you or (b) the time remaining on the original one-year warranty; whichever is longer.

What is not covered by this limited warranty?

This limited warranty does not cover:

1. Product that has been subjected to misuse, accident, shipping or other physical damage, improper installation, abnormal operation or handling, neglect, inundation, fire, water or other liquid intrusion;
2. Product that has been damaged due to repair, alteration or modification by anyone other than an authorized service representative of VTech;
3. Product to the extent that the problem experienced is caused by signal conditions, network reliability, or cable or antenna systems;
4. Product to the extent that the problem is caused by use with non-VTech accessories;
5. Product whose warranty/quality stickers, product serial number plates or electronic serial numbers have been removed, altered or rendered illegible;
6. Product purchased, used, serviced, or shipped for repair from outside the United States of America or Canada, or used for commercial or institutional purposes (including but not limited to Products used for rental purposes);
7. Product returned without a valid proof of purchase (see item 2 below); or
8. Charges for installation or set up, adjustment of customer controls, and installation or repair of systems outside the unit.

Limited warranty

How do you get warranty service?

To obtain warranty service in the USA, please visit our website at www.vtechphones.com or call 1 (800) 595-9511. In Canada, go to www.vtechcanada.com or call 1 (800) 267-7377.

NOTE: Before calling for service, please review the user's manual - a check of the Product's controls and features may save you a service call.

Except as provided by applicable law, you assume the risk of loss or damage during transit and transportation and are responsible for delivery or handling charges incurred in the transport of the Product(s) to the service location. VTech will return repaired or replaced Product under this limited warranty. Transportation, delivery or handling charges are prepaid. VTech assumes no risk for damage or loss of the Product in transit. If the Product failure is not covered by this limited warranty, or proof of purchase does not meet the terms of this limited warranty, VTech will notify you and will request that you authorize the cost of repair prior to any further repair activity. You must pay for the cost of repair and return shipping costs for the repair of Products that are not covered by this limited warranty.

What must you return with the Product to get warranty service?

1. Return the entire original package and contents including the Product to the VTech service location along with a description of the malfunction or difficulty; and
2. Include a "valid proof of purchase" (sales receipt) identifying the Product purchased (Product model) and the date of purchase or receipt; and
3. Provide your name, complete and correct mailing address, and telephone number.

Other limitations

This warranty is the complete and exclusive agreement between you and VTech. It supersedes all other written or oral communications related to this Product. VTech provides no other warranties for this Product. The warranty exclusively describes all of VTech's responsibilities regarding the Product. There are no other express warranties. No one is authorized to make modifications to this limited warranty and you should not rely on any such modification.

State/Provincial Law Rights: This warranty gives you specific legal rights, and you may also have other rights, which vary from state to state or province to province.

Limitations: Implied warranties, including those of fitness for a particular purpose and merchantability (an unwritten warranty that the Product is fit for ordinary use) are limited to one year from the date of purchase. Some states/provinces do not allow limitations on how long an implied warranty lasts, so the above limitation may not apply to you. In no event shall VTech be liable for any indirect, special, incidental, consequential, or similar damages (including, but not limited to lost profits or revenue, inability to use the Product or other associated equipment, the cost of substitute equipment, and claims by third parties) resulting from the use of this Product. Some states/provinces do not allow the exclusion or limitation of incidental or consequential damages, so the above limitation or exclusion may not apply to you.

Please retain your original sales receipt as proof of purchase

Technical specifications

Frequency control	Crystal controlled PLL synthesizer
Transmit frequency	Handset: 1921.536-1928.448 MHz Telephone base: 1921.536-1928.448 MHz
Channels	5
Nominal effective range	Maximum power allowed by FCC and IC. Actual operating range may vary according to environmental conditions at the time of use.
Power requirement	Handset: 1.2V, 500mAh, 3 x AAA Ni-MH battery Telephone base: 6V DC @ 800mA
Memory	Phonebook: 50 memory locations; up to 30 digits and 15 characters Caller ID log: 50 memory locations; up to 24 digits and 15 characters Call block: 1000 entries

Audio Assist® is a registered trademark of Advanced Amercian Telephones.

Qaltel™ is a trademark of Truecall Group Limited.



Specifications are subject to change without notice.
© 2019 VTech Communications, Inc.
All rights reserved. 02/19. SN5127_QSG_V2.0
Document order number: 96-012159-020-100