



Installation instructions for part 95-7417

Nissan Multi Kit 1993-2004 95-7417

KIT FEATURES

- ISO DDIN radio provision



KIT COMPONENTS

- A) ISO DDIN trim plate • B) ISO DDIN brackets

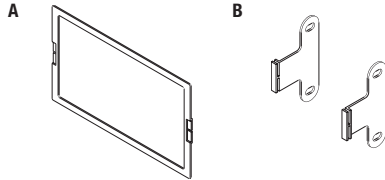

WIRING & ANTENNA CONNECTIONS (sold separately)

Wiring Harness: • Please visit metraonline.com for harness options

Antenna Adapter: • Please visit metraonline.com for antenna adapter options

APPLICATIONS

See application list inside cover

TOOLS REQUIRED

- Panel removal tool • Cutting tool
- Phillips screwdriver • Socket wrench

CAUTION! All accessories, switches, climate controls panels, and especially air bag indicator lights must be connected before cycling the ignition. Also, do not remove the factory radio with the key in the on position, or while the vehicle is running.

REV 7/28/2016 INST95-7417



95-7417

Applications

INFINITI

I-30	1996-1999
QX4	1997-2000

MERCURY

Villager	1993-2002
----------	-----------

NISSAN

200SX	1995-1998
240SX	1995-1998
Altima	1998-2001

NISSAN (Cont'd)

Frontier	1998-2004
Maxima	1995-1999
Maxima (without wrap around radio)	2000-2003
Pathfinder	1996-2000
Pathfinder (without NAV)	2001-2002
Pathfinder SE	2003-2004
Quest	1993-2003
Sentra	1995-1999
Xterra	2000-2004

Table of Contents

Dash Disassembly 3-6

Infiniti

- I-30 1996-1999	3
- QX4 1997-2000	3

Mercury

- Villager 1993-1995	3
- Villager 1996-1998	3
- Villager 1999-2002	4

Nissan

- 200SX 1995-1998	4
- 240SX 1995-1998	4
- Altima 1998-2001	5
- Frontier 1998-2001	5
- Frontier 2002-2004	5

Nissan (Cont'd)

- Maxima 1995-1999	5
- Maxima (without wrap around radio) 2000-2003	6
- Pathfinder 1996-2000	3
- Pathfinder (without NAV) 2001-2002	6
- Pathfinder SE 2003-2004	6
- Quest 1993-1995	3
- Quest 1996-1998	3
- Quest 1999-2003	4
- Sentra 1995-1999	4
- Xterra 2000-2001	5
- Xterra 2002-2004	5
Kit Assembly	7

Dash Disassembly

Infiniti I-30 1996-1999

1. Unclip and remove the shift lever trim panel, and remove the (2) screws exposed.
2. Remove (1) screw to the left of the ashtray then unclip and remove the ashtray assembly.
3. Unclip and remove the clock/vent assembly.
4. Remove (4) screws securing the radio and then remove.

Continue to kit assembly

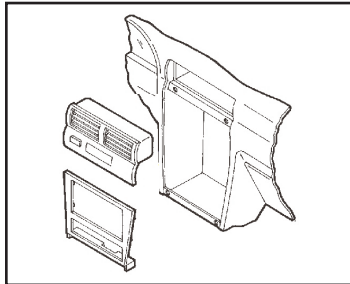

Infiniti QX4 1997-2000

Nissan Pathfinder 1996-2000

1. Remove (2) Phillips screws from the base of the radio trim panel.
2. Unclip and remove the radio trim panel.
3. Remove (4) screws securing the radio and then remove.

Continue to kit assembly

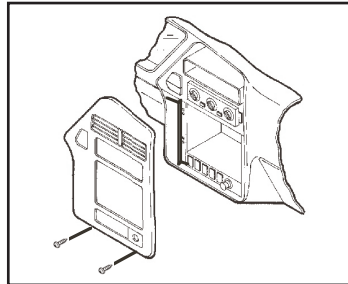

Mercury Villager 1993-1995

Nissan Quest 1993-1995

1. Remove (1) screw above the climate controls.
2. Unclip and remove the radio trim panel.
3. Remove (4) screws securing the radio and then remove.

Continue to kit assembly

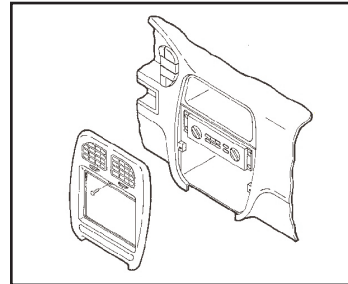

Mercury Villager 1996-1998

Nissan Quest 1996-1998

1. Remove (4) plastic screws and screw anchors from the base of the storage compartment, then remove the compartment.
2. Remove (2) Phillips screws from the base of the radio trim panel.
3. Remove (2) Phillips screws from above the radio opening and then remove the ashtray.
4. Remove (4) screws securing the radio and then remove.

Continue to kit assembly

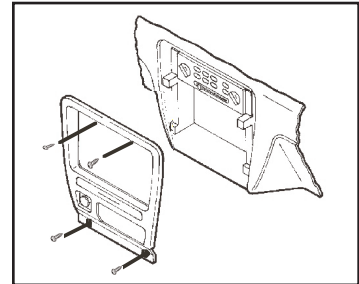

Dash Disassembly

Mercury Villager 1999-2002

Nissan Quest 1999-2003

1. Open the ashtray/cupholder assembly, and depress the retaining clips on each side to remove.
2. Remove (2) Phillips screws from each side of the ashtray/cupholder.
3. Remove (4) plastic rivets from the lower pocket and slide the pocket back.

Note: *It is not necessary to fully remove the pocket.*

4. Unclip the dash trim panel and remove.
5. Remove (4) screws securing the radio and then remove.

Continue to kit assembly

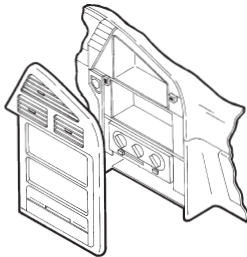

Nissan 200SX 1995-1998

Nissan Sentra 1995-1999

1. Unclip and remove the dummy plate above the climate controls.
2. Remove (1) Phillips screw from behind dummy plate and then unclip and remove radio trim panel.
3. Remove (4) screws securing the radio and then remove.

Continue to kit assembly

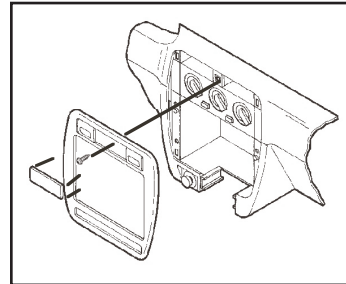

Nissan 240SX 1995-1998

1. Unclip and remove the climate control trim panel, and remove the (2) screws exposed behind.
2. Unclip and remove the shift lever trim panel, and remove the (2) screws exposed behind.
3. Remove the ashtray and (1) Phillips screw exposed in the ashtray cavity.
4. Unclip and remove the radio trim panel, factory radio and pocket assembly.

Continue to kit assembly

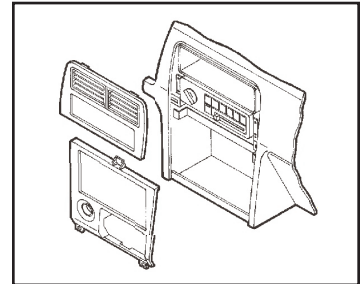

Dash Disassembly

Nissan Altima 1998-2001

1. Unclip the shift lever trim panel and remove (2) Phillips screws at the base of the radio trim panel.
2. Remove (2) Phillips screws above the radio opening.
3. Unclip and remove the radio trim panel.
4. Remove (4) screws securing the radio and then remove.

Continue to kit assembly

Nissan Frontier 1998-2001

Nissan Xterra 2000-2001

1. Remove the ashtray and the (2) Phillips screws exposed in the ashtray cavity.
2. Unclip and remove the radio trim panel.
3. Remove (4) screws securing the radio and then remove.

Continue to kit assembly

Nissan Frontier 2002-2004

Nissan Xterra 2002-2004

1. Unclip and remove the shift lever trim panel.
2. Remove (2) Phillips screws exposed in the shift lever cavity.
3. Remove (2) Phillips screws under the climate control.
4. Unclip and remove the radio trim panel.
5. Remove (4) screws securing the radio and then remove.

Continue to kit assembly

Nissan Maxima 1995-1999

1. Unclip the shift lever trim panel.
2. Remove the (2) Phillips screws at the base of the radio trim panel.
3. Remove (1) Phillips screw to the left of the ashtray and unclip the ashtray assembly.
4. Unclip and remove the clock/vent assembly.
5. Remove (4) screws securing the radio and then remove.

Continue to kit assembly

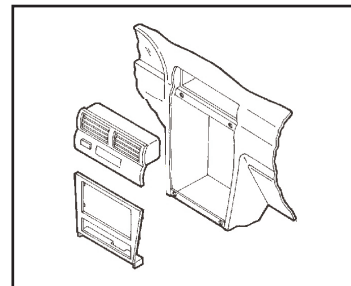
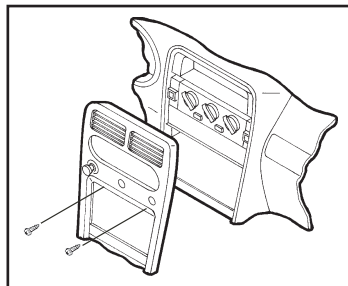
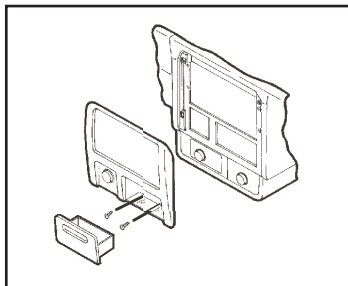
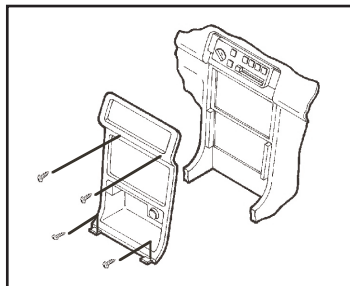

Dash Disassembly

Nissan Maxima (without wrap around radio) 2000-2003

1. Unclip and remove the vent/radio trim panel.

Note: For Bose systems the vent assembly will be removed without the trim panel.

2. Remove the ashtray insert and (1) Phillips screw exposed behind.
3. Unclip and remove the shift lever/ashtray trim panel.
4. Remove (2) Phillips screws above the radio, and (2) Phillips screws below the climate control panel.
5. Remove the radio/climate control assembly.

Continue to kit assembly

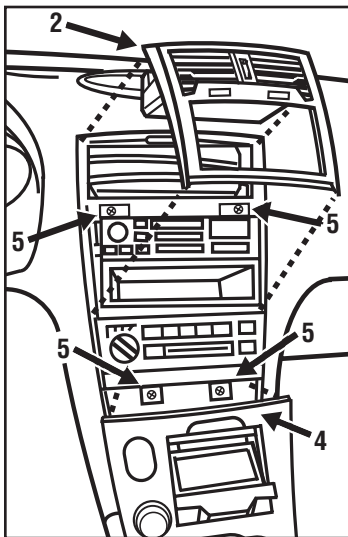

Nissan Pathfinder (without NAV) 2001-2002

Nissan Pathfinder SE 2003-2004

1. Unclip and remove the vent/clock assembly. (Figure A)
2. Remove (2) Phillips screws from the top of the radio trim panel, then remove the panel. (Figure B)
3. Remove (4) screws securing the radio and then remove. (Figure C)

Continue to kit assembly

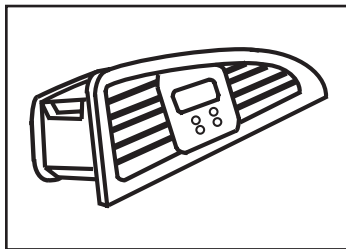

(Figure A)

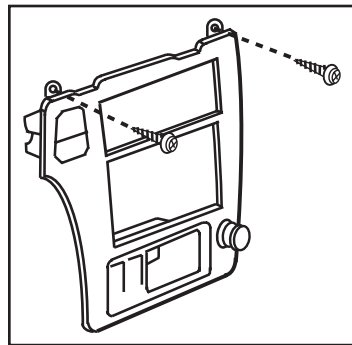

(Figure B)

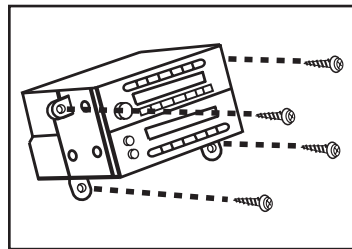

(Figure C)

Kit Assembly

ISO DDIN radio provision

1. Slide the *ISO DDIN brackets* into the *ISO DDIN trim plate* aligning the holes in the trim plate to the clips on the bracket. (Figure A)
2. Remove the factory radio and optional pocket (if equipped) from the radio brackets.
3. Attach the factory mounting brackets and the *ISO DDIN trim plate/bracket assembly* to the radio with the screws supplied with the radio. (Figure B)
4. Locate the factory wiring harness and antenna connector in the dash, and complete all necessary connections to the radio. Metra recommends using the proper mating adapter from Metra and/or AXCESS. Test the radio for proper operation.
5. Reassemble the dash in reverse order of disassembly.

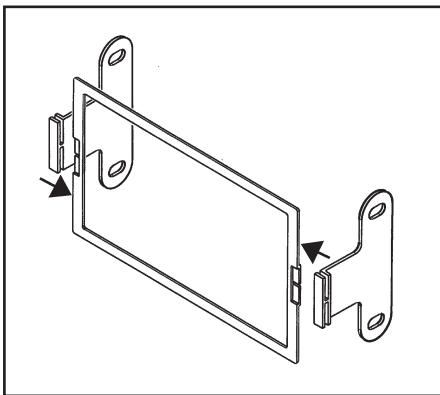

(Figure A)

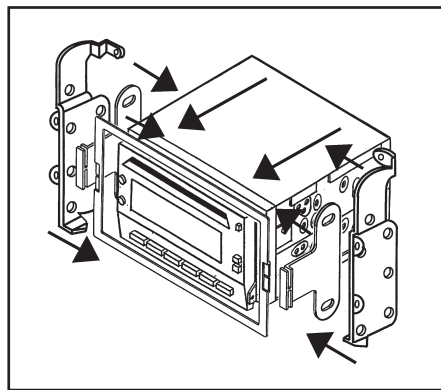

(Figure B)



Installation instructions for part 95-7417



REV. 7/28/2016 INST95-7417

IMPORTANT

If you are having difficulties with the installation of this product, please call our Tech Support line at **1-800-253-TECH**. Before doing so, look over the instructions a second time, and make sure the installation was performed exactly as the instructions are stated. Please have the vehicle apart and ready to perform troubleshooting steps before calling.



KNOWLEDGE IS POWER

Enhance your installation and fabrication skills by enrolling in the most recognized and respected mobile electronics school in our industry. Log onto www.installerinstitute.com or call 800-354-6782 for more information and take steps toward a better tomorrow.



Metra recommends MECP certified technicians



Instrucciones de instalación para la pieza 95-7417

Nissan Multi Kit 1993-2004 95-7417

CARACTERÍSTICAS DEL KIT

- Provisión de radio ISO DDIN



COMPONENTES DEL KIT

- A) Placa de moldura ISO DDIN • B) Soportes ISO DDIN

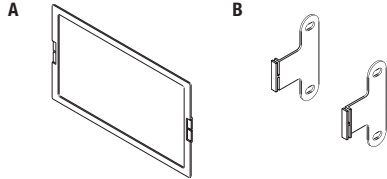

CABLEADO Y CONEXIONES DE ANTENA (se venden por separado)

Arnés de cableado: • Visite metraonline.com para las opciones del arnés

Adaptador de antena: • Visite metraonline.com para las opciones de adaptadores

APLICACIONES

Ver interior de la portada

HERRAMIENTAS REQUERIDAS

- Herramienta para quitar paneles • Herramienta de corte
- Destornillador Phillips • llave de tubo

¡PRECAUCIÓN! Todos los accesorios, interruptores, paneles de controles de clima y especialmente las luces del indicador de las bolsas de aire deben estar conectados antes de ciclar la ignición. Además, no quite el radio de fábrica con la llave en la posición o de encendido ni con el vehículo funcionando.

Aplicaciones

INFINITI

I-30	1996-1999
QX4	1997-2000

MERCURY

Villager	1993-2002
----------	-----------

NISSAN

200SX	1995-1998
240SX	1995-1998
Altima	1998-2001

NISSAN (Cont)

Frontier	1998-2004
Maxima	1995-1999
Maxima (sin envoltura alrededor de radio)	2000-2003
Pathfinder	1996-2000
Pathfinder (sin NAV)	2001-2002
Pathfinder SE	2003-2004
Quest	1993-2003
Sentra	1995-1999
Xterra	2000-2004

Indice

Desmontaje del tablero..... 3-6

Infiniti

- I-30 1996-1999	3
- QX4 1997-2000	3

Mercury

- Villager 1993-1995	3
- Villager 1996-1998	3
- Villager 1999-2002	4

Nissan

- 200SX 1995-1998	4
- 240SX 1995-1998	4
- Altima 1998-2001	5
- Frontier 1998-2001	5
- Frontier 2002-2004	5

Nissan (Cont)

- Maxima 1995-1999	5
- Maxima (sin envoltura alrededor de radio) 2000-2003	6
- Pathfinder 1996-2000	3
- Pathfinder (sin NAV) 2001-2002	6
- Pathfinder SE 2003-2004	6
- Quest 1993-1995	3
- Quest 1996-1998	3
- Quest 1999-2003	4
- Sentra 1995-1999	4
- Xterra 2000-2001	5
- Xterra 2002-2004	5
Ensamble del kit	7

Desmontaje del tablero

Infiniti I-30 1996-1999

1. Desenganche y quite el panel de moldura de palanca de cambio y quite los (2) tornillos expuestos.
2. Quite (1) tornillo a la izquierda del cenicero y luego desenganche y quite el ensamble del cenicero.
3. Desenganche el ensamble de reloj/ rejilla y retire.
4. Quite los (4) tornillos que sujetan de radio y quite.

Continúe con el ensamble del kit

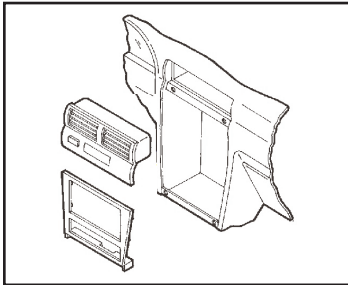

Infiniti QX4 1997-2000

Nissan Pathfinder 1996-2000

1. Quite (2) tornillos Phillips de la base de la panel de moldura de radio.
2. Desenganche y quite el panel de la moldura del radio.
3. Quite los (4) tornillos que sujetan de radio y quite.

Continúe con el ensamble del kit

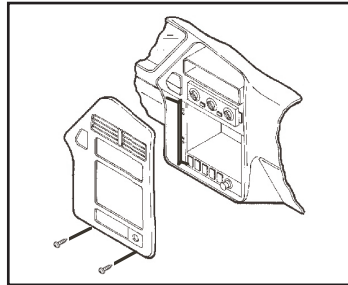

Mercury Villager 1993-1995

Nissan Quest 1993-1995

1. Quite el tornillo (1) arriba del los controles de clima.
2. Desenganche y quite el panel de la moldura del radio.
3. Quite los (4) tornillos que sujetan de radio y quite.

Continúe con el ensamble del kit

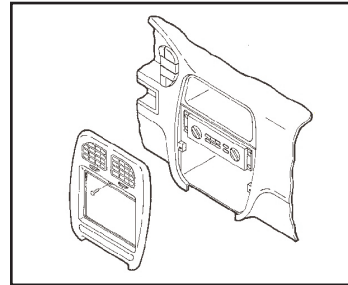

Mercury Villager 1996-1998

Nissan Quest 1996-1998

1. Quite los (4) tornillos de plástico y atornille las anclas desde la base del compartimiento de almacenamiento, luego retire el compartimiento.
2. Quite (2) tornillos Phillips de la base de la panel de moldura de radio.
3. Quite los (2) tornillos Phillips de arriba de la apertura del radio y luego quite el cenicero.
4. Quite los (4) tornillos que sujetan de radio y quite.

Continúe con el ensamble del kit

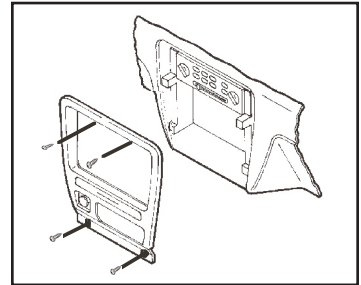

Desmontaje del tablero

Mercury Villager 1999-2002

Nissan Quest 1999-2003

1. Abra el cenicero/ensamble del portavasos, y presione los ganchos de retención en cada lado para quitar.
2. Quite (2) tornillos Phillips de cada lado de la cenicero/portavasos.
3. Quite los (4) remaches de plástico de la cavidad inferior y deslice la cavidad hacia atrás.

Nota: No es necesario retirar la cavidad.

4. Desenganche del panel de la moldura del tablero y quitar.
5. Quite los (4) tornillos que sujetan de radio y quite.

Continúe con el ensamble del kit

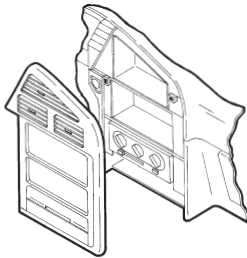

Nissan 200SX 1995-1998

Nissan Sentra 1995-1999

1. Desenganche y quite la placa simuladora de arriba de los controles de clima.
2. Quite (1) tornillo Phillips de atrás de la placa simuladora y luego desenganche y quite el panel de la moldura del radio.
3. Quite los (4) tornillos que sujetan de radio y quite.

Continúe con el ensamble del kit

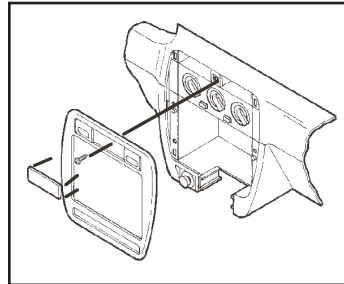

Nissan 240SX 1995-1998

1. Desenganche y quite el panel de la moldura de control del clima, y quite (2) tornillos expuestos detrás.
2. Desenganche y quite el panel de moldura de palanca de cambio y quite los (2) tornillos expuestos detrás.
3. Quite el cenicero y (1) tornillos Phillips expuestos en la cavidad del cenicero.
4. Desenganche y quite el panel de la moldura del radio, radio de la fábrica y cavidad asamblea.

Continúe con el ensamble del kit

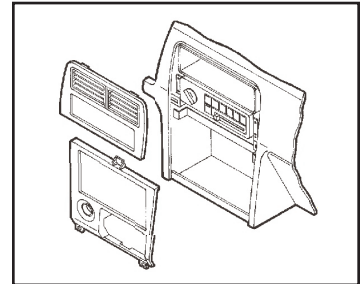

Desmontaje del tablero

Nissan Altima 1998-2001

1. Desenganche el panel de moldura de palanca de cambio y quite (2) tornillos Phillips de la base de la panel de moldura de radio.
2. Quite los (2) tornillos Phillips arriba de la abertura de radio.
3. Desenganche y quite el panel de la moldura del radio.
4. Quite los (4) tornillos que sujetan de radio y quite.

Continúe con el ensamble del kit

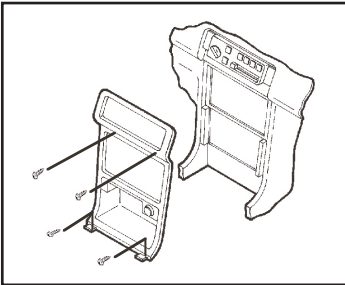

Nissan Frontier 1998-2001

Nissan Xterra 2000-2001

1. Quite el cenicero y los (2) tornillos Phillips expuestos en la cavidad del cenicero.
2. Desenganche y quite el panel de la moldura del radio.
3. Quite los (4) tornillos que sujetan de radio y quite.

Continúe con el ensamble del kit

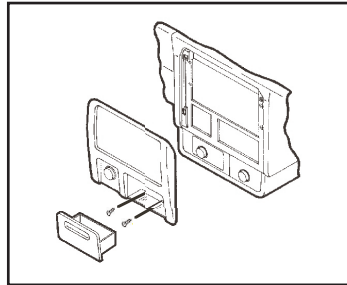

Nissan Frontier 2002-2004

Nissan Xterra 2002-2004

1. Desenganche y quite el panel de moldura de palanca de cambio.
2. Quite los (2) tornillos Phillips expuestos en la cavidad de palanca de cambio.
3. Quite (2) tornillos Phillips que están debajo del panel de control de clima.
4. Desenganche y quite el panel de la moldura del radio.
5. Quite los (4) tornillos que sujetan de radio y quite.

Continúe con el ensamble del kit

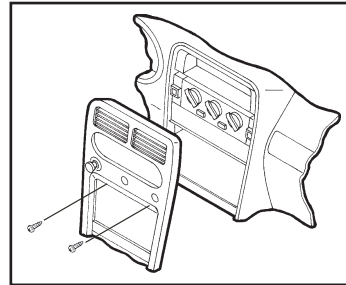

Nissan Maxima 1995-1999

1. Desenganche el panel de moldura de palanca de cambio.
2. Quite (2) tornillos Phillips de la base de la panel de moldura de radio.
3. Quite (1) tornillo Phillips a la izquierda del cenicero y desenganche el ensamble del cenicero.
4. Desenganche y quite el ensamble de reloj/rejilla.
5. Quite los (4) tornillos que sujetan de radio y quite.

Continúe con el ensamble del kit

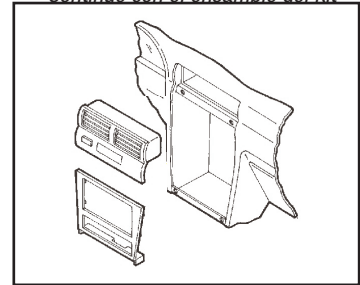

Desmontaje del tablero

Nissan Maxima (sin envoltura alrededor de radio) 2000-2003

1. Desenganche y quite la ventilación/panel de moldura de radio.

Nota: En los sistemas Bose, el ensamble de la rejilla se quitará sin el panel de la moldura.

2. Quite el cenicero y (1) tornillos Phillips expuestos detrás.
3. Desenganche y quite el palanca de cambio / panel de moldura de cenicero.
4. Quite los (2) tornillos Phillips arriba de radio y (2) tornillos Phillips panel de abajo del panel del control del clima.
5. Quite el radio/conjunto de control climático.

Continúe con el ensamble del kit

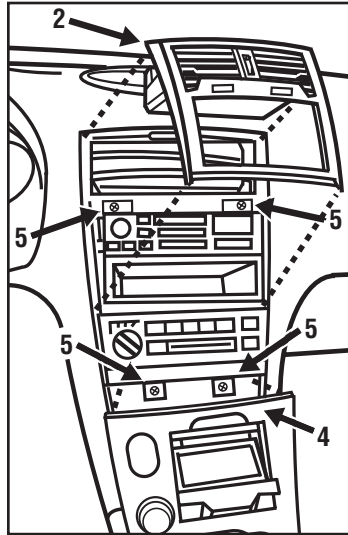

Nissan Pathfinder (sin NAV) 2001-2002

Nissan Pathfinder SE 2003-2004

1. Desenganche y quite la rejilla/hora ensamble. (Figura A)
2. Quite los (2) tornillos Phillips de la parte superior del bisel de la moldura del radio y quite el bisel. (Figura B)
3. Quite los (4) tornillos que sujetan de radio y quite. (Figura C)

Continúe con el ensamble del kit

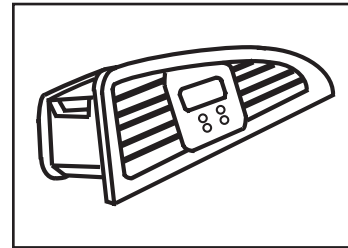

(Figura A)

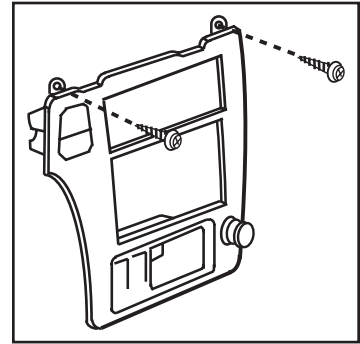

(Figura B)

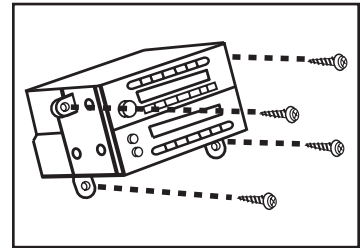

(Figura C)

Ensamble del kit

Provisión de radio ISO DDIN

1. Deslice el *soportes ISO DDIN* en la *placa de la moldura ISO DDIN*, alineando los orificios de la placa de la moldura con los ganchos del soporte. (Figura A)
2. Quite la radio de fábrica y bolsillo opcional (Si está equipado) de los soportes de radio.
3. Coloque los soportes de montaje de fábrica y las *placas de moldura ISO DDIN*/soportes ensamble al radio con los tornillos suministrados con el radio. (Figura B)
4. Localice el arnés de cableado de fábrica y el conector de la antena en el tablero, y haga todas las conexiones necesarias al radio. Metra recomienda que use adaptadores adecuados de acoplamiento de Metra y/o de AXXESS. Pruebe el radio para verificar que funcione correctamente.
5. Vuelva a armar el tablero al revés de como lo desarmó.

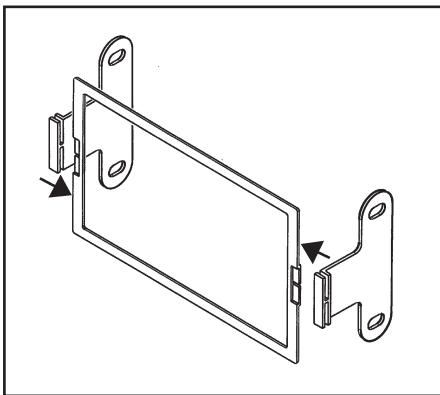

(Figura A)

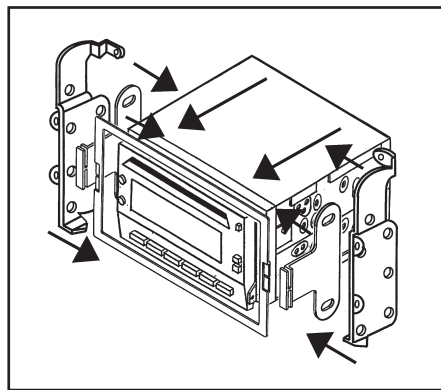

(Figura B)



Instrucciones de instalación para la pieza 95-7417



IMPORTANTE

Si tiene dificultades con la instalación de este producto, llame a nuestra línea de soporte técnico al **1-800-253-TECH**. Antes de hacerlo, revise las instrucciones por segunda vez y asegúrese de que la instalación se haya realizado exactamente como se indica en las instrucciones. Por favor tenga el vehículo desarmado y listo para ejecutar los pasos de resolución de problemas antes de llamar.



EL CONOCIMIENTO ES PODER

Mejore sus habilidades de instalación y fabricación inscribiéndose en la escuela de dispositivos electrónicos móviles más reconocida y respetada de nuestra industria. Regístrese en www.installerinstitute.com o llame al 800-354-6782 para obtener más información y avance hacia un futuro mejor.



Metra recomienda técnicos con certificación del Programa de Certificación en Electrónica Móvil (Mobile Electronics Certification Program, MECP).