

Karaoke USA

DVD / MP3G / CDG KARAOKE & BLUETOOTH MEDIA PLAYER

- English
- Español
- Français

EN User's Guide

MODEL:
GF846



Smart Device not included

Before operating this product, please read these instructions.

Contents

Warnings and Precautions.....	01
Important Safety Instructions.....	02
Caution.....	03
What's in the Gift Box.....	04
Song List on your Disc.....	05-06
Features.....	07
Front Panel Illustration.....	08
Top Panel Illustration.....	09
Connecting to a TV Set.....	10
Smart Device connection.....	10
Remote Control.....	11
Remote Control Operation.....	12-15
How to Play a Disc.....	16
MP3G Disc and MP3G Format Music Playback.....	17
Play Bluetooth Music.....	18
Play SD Card and USB.....	19
Record Operation Procedures.....	20
Playback the Recorded File.....	21
The Setup Menu System.....	22-23
Specifications.....	24
Troubleshooting.....	25-26
Notes on SD Card.....	27

Warnings and Precautions

WARNING: To reduce the risk of fire or electric shock, do not expose this unit to rain or moisture.

CAUTION: Use of controls or adjustments or performance of procedures other than those specified may result in hazardous radiation exposure.

“**Caution Marking and Rating Label**” is affixed under the lid or on the bottom of the unit with a mass not exceeding 7kg.

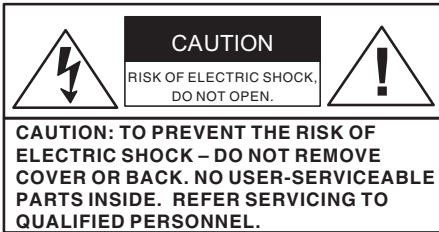

This symbol is intended to alert you to the presence of uninsulated, dangerous voltage within the unit's enclosure that might be of a sufficient magnitude to constitute a risk of electric shock. **DO NOT OPEN THE UNITS CASE.**



This symbol is intended to inform you that important operating and maintenance instructions are included in the literature accompanying this product.

SAFETY

For units with an insertable AC Power Adapter cord set:

- The power adapter should remain operable for its intended use. Disconnect the AC Power Adapter if you are not intending to use the unit for a long period of time.
- When connecting or disconnecting the AC Power Adapter Cord, grip the plug and not the cord itself. Pulling the cord may cause damage and create a hazard.

For units with a Rechargeable Battery:

- Do not expose batteries to excessive conditions – extreme cold, heat, sun or fire.

MOISTURE AND CONDENSATION

If the unit is exposed to moisture and extreme cold temperatures and moved to a warm environment, condensation may form on the units internal components. Under these circumstances, turning the power “ON” may cause damage to the unit or cause harm to the user. Allow the unit to stand in a warm environment for 1 to 3 hours and allow the unit to air dry safely.

WHEN IN USE

- Do not use this unit in conditions that are extreme – hot, cold, dusty or humid.
- Do not restrict the air flow of the unit by placing it on a soft surface like a bed, carpet or covering.

FCC INFORMATION

This unit complies with part 15 of the “FCC Rules.” Operation is subject to the following conditions:

1. This unit may not cause harmful interference.
2. This unit must accept any interference received, including interference that may cause undesirable operation.



Double insulation.
This is a Class II apparatus.

Important Safety Instructions

1. Read These Instructions: All safety and operations manual should be read before the product is operated.

2. Keep These Instructions: The safety and operations manual should be retained for future reference.

3. Heed All Warnings: All warnings applicable to the unit and in the operations manual should be adhered to.

4. Follow All Instructions: All operations manual should be followed.

5. Water and Moisture: Do not use this unit near water. For example, do not use near a bath tub, wash bowl, kitchen sink, or laundry tub. Do not use this unit in a wet basement or near a swimming pool or similar location. The unit shall not be exposed to dripping or splashing and no objects filled with liquids (ex: vases), shall be placed on or near this unit.

6. Cleaning: Clean the unit only with a dry cloth. Unit must be unplugged from the wall outlet before cleaning. Do not use liquid cleaners or aerosol cleaners on the unit.

7. Ventilation: Slots and openings in the cabinet of the unit are provided to ensure reliable operation and ventilation and to protect the unit from overheating. The openings must not be covered and should never be blocked by placing the product on a soft surface like a bed, sofa, or rug. This unit should not be placed in a built-in installation like a bookcase or rack, unless proper ventilation is provided.

8. Heat: Do not install the unit near any heat source like a radiator, heat register, stove or other device that produces heat, including amplifiers.

9. Grounding or Polarization: If applicable, do not disable or circumvent the polarized or grounding-type plug. A polarized plug has 2 blades with 1 wider than the other. A grounding-type plug has 2 blades and a 3rd grounding plug. The wide blade, or the 3rd prong, is provided for your safety. If the provided plug does not fit into an outlet, consult a qualified electrician for replacement of this outlet.

10. Power Cord Protection: Protect the power cord from being walked on, pinched or cut or damaged in any

way. If any damage occurs, consult with a trained technician for repair.

11. Accessories: Only use accessories specified and approved by the manufacturer. Do not place this unit on an unstable cart, stand, tripod, bracket or table that has not been previously approved by the manufacturer. This unit may fall, causing serious injury to a child, adult or to the unit itself. Any mounting of the unit should be done within the manufacturer's guidelines.

12. Transporting: If a pre-approved device is used to transport this unit, caution and care must be observed and practiced to avoid damages. Make sure the device and unit together are stable before moving.



PORTABLE
CART
WARNING

S3125A

13. Lightning: Unplug this unit and disconnect the antenna or cable system during lightning storms or when unused for long periods of time. This will help prevent damage to the unit due to lightning and power line surges.

14. Servicing: Do not attempt to service this unit yourself. Opening or removing covers may expose you to dangerous voltage or other hazards. Refer all servicing to a qualified service technician.

15. Power Sources: Only connect to the type of household power supply as indicated in the operations manual and "Caution Marking and Rating Label." If you are not sure of the type of power supplied to your home (or location of the outlet the unit is being plugged into), consult with the local power company. For units intended to operate from battery power, or other sources, refer to the manufacturer's operations manual.

16. Overloading: Do not overload wall outlets or extension cords. This can result in a risk of fire or electric shock and may be hazardous.

17. Foreign Material: Protect this unit from intrusion of any foreign substances like dirt, water, moisture and insects. Do not force any foreign materials or chemicals into this unit. This could result in a risk of fire or electric shock and may be hazardous.

18. Replacement Parts and Safety Check: When replacement parts are required, be sure the service technician has used replacement parts specified and approved by the manufacturer. Ask the service technician to perform safety checks to ensure the proper operation to avoid possible fire, electric shock or other hazards.

19. Outdoor Antenna Grounding: If an outside antenna or cable system is connected to the unit, be sure the antenna or cable system is grounded to provide some protection against voltage surges and built-up static charges. If there is any doubt to the proper grounding of these systems, contact a qualified electrician to inspect your location.

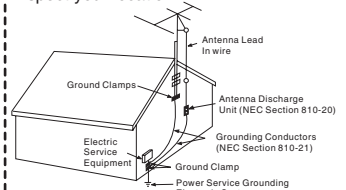

20. Wall or Ceiling Mounted: The unit should be mounted to a wall or a ceiling only as recommended by the manufacturer.

21. Disconnect Device: Make sure all disconnect devices are in proper working condition and readily available in the event of an emergency or if power "off" is needed quickly.

22. Protective Attachment Plug: If applicable, this unit may be equipped with an attachment plug having overload protection. This is a safety feature. See the operations manual for replacement or resetting of this protective device. If replacement of the plug is required, be sure the qualified service technician has used a replacement plug specified by the manufacturer that has the same overload protection as the original plug.

23. Power Lines: An outside antenna system should not be located in the vicinity of overhead power lines or other electric light or power circuits, or where it can fall into such power lines or circuits. When installing an outside antenna system, extreme care should be taken to keep from touching such power lines or circuits, as contact with them may be fatal. Always consult with your local power company before installing an outside antenna.

Caution

- Please use the original box and packing materials for safe transportation of this product.

- It is normal for the cover and rear panel to become warm after the player has been operating for an extended period of time.

- Do not move this product during playing. Doing so may cause damage to the pickup and the disc.

- Press OPEN CD DOOR button to open tray. Do not pull the tray. Do not touch tray when opening or closing.

- USB Flash Devices and SD Cards should be formatted to FAT32 on your computer before use.

- When EQ function /key control is turned on, the Recording effect/result would not be ideal.

- Do not use hard or sharp instruments to touch the TFT Screen, it may scratch or damage its surface!

What's in the Gift Box



GF846 X1



Microphone x 2



RCA Cable x 1



Smart Device
Holder x 1



AC Adaptor x 1
DC12V/2A



2 AAA Batteries
Not Included

Remote
Control x 1

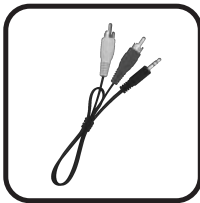

Cable for
Smart Device x 1

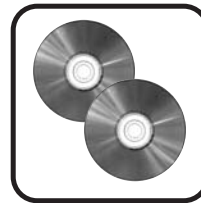

MP3G Demo
Disc x 2



User's Guide x 1



Warranty Card x 1

Song List on your Discs

9347 Sing A Long Karaoke Songs (200 Traditional Karaoke Songs)

- Alexander's Ragtime Band
- All Things Bright And Beautiful
- All Through The Night
- Alouette
- Alphabet Song, The
- America (My Country Tis Of Thee)
- Animal Fair
- Around And Around The Village
- Aye Aye Aye The Limerick Song
- B I N G O
- Baa Baa Black Sheep
- Barney Buntline
- Be Kind To Your Web Footed Friends
- Bear Went Over The Mountain
- Big Rock Candy Mountain
- Billy Boy
- Billy Fringle
- Bird's Song
- Blessed Assurance
- Blow The Man Down
- Blue Bells Of Scotland
- Bluebird
- Bollweevil
- Bye, Baby Bunting
- Caissons Go Rolling Along
- Calendar Song
- Camptown Races
- Capital Ship, A
- Cat Came Back, The
- Cinderella
- Clementine
- Cock A Doodle Doo
- Cockles And Mussels
- Cocky Robin
- Colors
- Come, O Come, Emanuel
- Counting Song
- Crawdad Song
- Crocodile, The
- Cuckoo Is A Pretty Bird
- Day And Night
- Dixie
- Do Your Ears Hang Low
- Dry Bones
- Elephant And The Flea
- Father Grumble
- Fiddle De De
- Fishes
- Five Currant Buns
- For He's A Jolly Good Fellow
- For Me And My Gal
- Fox
- Frere Jacques
- Froggie Went A Courting
- Georgie Porgie
- German Lullaby
- Girls And Boys Come Out To Play
- Git Along Little Dogies
- Golden Slumbers
- Good Morning Merry Sunshine
- Goosey Goosey Gander
- Grasshopper
- Grasshoppers Three
- Greensleeves
- Ground Hog
- Harrigan
- Here We Go Around The Mulberry Bush
- Here We Go Looby Loo
- Hey Diddle Diddle
- Hickory Dickory Dock
- Higgledy Piggledy My Black Hen
- Home On The Range
- Humpty Dumpty
- Hunting We Will Go, A
- Hush Little Baby
- Hush-a-bye
- I Am A Young Musician
- I Gave My Love A Cherry
- I Had A Little Nut Tree
- I Love You Truly
- I Spy
- If You're Happy And You Know It
- I'll Take You Home Again, Kathleen
- I'm A Little Teapot
- I'm Always Chasing Rainbows
- I'm Looking Over A Four Leaf Clover
- In The Good Old Summertime
- It Ain't Gonna Rain No More
- It's Raining It's Pouring
- I've Been Working On The Railroad
- Jack And Jill
- Jack Be Nimble
- Jack Spratt
- Jenny Jenkins
- Jimmy Crack Corn
- Lady Bird Lady Bird
- Letters Of The Alphabet
- Little Black Bull
- Little Boy Blue
- Little Jack Horner
- Little Sally Waters
- Little Things, The
- Little Tommy Tucker
- London Bridge Falling Down
- London Street
- Ma She's Making Eyes At Me
- Mademoiselle From Armentieres
- Marine's Hymn
- Michael Row The Boat Ashore
- Midnight Special, The
- Moonlight Bay
- My Old Dog Tray
- My Old Hen
- Now I Lay Me Down To Sleep
- Oats Beans And Barley Grow
- Off To Bed Now
- Oh Dear What Can The Matter Be
- Ol Woman Who Lived In A Shoe
- Old Blue
- Old John Braddlem
- Old Mother Hubbard
- On The Banks Of The Sacramento
- On Top Of Old Smokey
- One Meat Ball
- One Two Buckle My Shoe
- One Two Three Four Five
- Oranges And Lemons
- Over In The Meadow
- Over The River And Through The Woods
- Pat A Cake
- Pease Porridge Hot
- Peg O' My Heart
- Peter Peter Pumpkin Eater
- Polly Put The Kettle On
- Polly Wolly Doodle
- Pop Goes The Weasel
- Ride A Cock Horse To Banbury Cross
- Right Hand Says Good Morning
- Ring Around The Rosie
- Rise And Shine
- Rock A Bye Baby
- Rock A Bye Baby Green
- Rock Island Line
- Rocking The Cradle
- Rose Of Tralee
- Row Row Row Your Boat
- Russian Cradle Song
- Sailing Sailing
- School Days
- She'll Be Coming Around The Mountain
- Shoo Fly Don't Bother Me
- Shortening Bread
- Simple Simon
- Sing A Song Of Sixpence
- Six Little Ducks
- Skip To My Lou
- Sleep Baby Sleep
- Spelling
- Spider And The Fly, The
- Star Spangled Banner, The
- Sur Le Pont D'avignon
- Swanee River
- Sweetly Sings The Donkey
- Swing Low Sweet Chariot
- Tailor And The Mouse
- Take Me Out To The Ball Game
- Ten In A Bed
- The Ants Go Marching
- The Eensy Weensy Spider
- The Farmer In The Dell
- The Holly And The Ivy
- The Muffin Man
- The Old Gray Mare
- There Was A Little Man
- There Was A Tree
- There's A Hole In Middle Of Sea
- This Little Pig Went To Market
- This Old Man
- Three Blind Mice
- Three Little Kittens
- Three Little Pigs
- Tisket A Tasket, A
- To Market To Market
- Too Toot Toosie Goodbye
- Try Try Again
- Tura Lura Lura
- Turkey In The Straw
- Vive La Compagne
- Wabash Cannonball, The
- Waltzing Matilda
- We Hunted And We Hunted
- We Three Kings
- What Child Is This
- When Johnny Comes Marching Home
- Where Oh Where Has My Little Dog Gone
- Who Threw The Overalls In Mrs. Murphy's Chowder
- Wish You A Happy Birthday
- World Turned Upside Down, The
- Yankee Doodle
- Yellow Rose Of Texas

Any and all discs shown are for illustration only and may or may not represent the actual disc(s) included in this package

Song List on your Discs

9346 Favorite Karaoke Songs (100 Traditional English and Spanish Karaoke Songs)

1. Abide With Me
2. Amazing Grace
3. Angel De Los Reinos Santos
4. Angels From The Realms Of Glory
5. Angels We Have Heard On High
6. April Shower
7. Auld Lang Syne
8. Ave Maria
9. Away In A Manger
10. Battle Hymn Of The Republic
11. Bicycle Built For Two
12. Bill Bailey, Won't You Come Home
13. Boom, Boom, Ain't It Great To Be Crazy
14. Brah'm's Lullaby
15. Bringing In The Sheaves
16. Campanas de Navidad
17. Church in The Wildwood
18. Con Mi Burrito Sabanero
19. Daddy Sang Bass
20. Danny Boy
21. Deck The Halls
22. Ding Dong Que Alegria
23. Doce Dias De Navidad
24. Down By The Riverside
25. El Buen Rey Weceslao
26. El Primer Noel
27. El Tamborilero
28. First Noel, The
29. Frankie And Johnny
30. Give My Regards To Broadway
31. Go Tell It On The Mountain
32. God Rest Ye Merry Gentlemen
33. Hail Hail The Gang's All Here
34. Hark! The Herald Angels Sing
35. He's Got The Whole World In His Hand
36. His Eye Is On The Sparrow
37. How Great Thou Art
38. I Love To Tell The Story
39. I'll Fly Away
40. In The Garden
41. It Came Upon A Midnight Clear
42. It Is No Secret What God Can Do
43. Jeannie With The Light Brown Hair
44. Jesus Loves Me
45. Jingle Bells (Childrens)
46. Joy To The World
47. Just A Closer Walk With Thee
48. Let Me Call You Sweetheart
49. Little Bo Peep
50. Little Miss Muffet
51. Llego A Mi Medianoche
52. Los Tres Reyes
53. Mary Had A Little Lamb
54. Mary Quite Contrary
55. Mozart's Lullaby
56. My Bonnie Lies Over The Ocean
57. My Old Kentucky Home
58. My Wild Irish Rose
59. Navidad, Navidad
60. Noche De Paz
61. Noche Santa
62. O Holy Night
63. Oh Christmas Tree
64. Oh Come All Ye Faithful
65. Oh Little Town Of Bethlehem
66. Oh Ven Oh Ven Emmanuel
67. Oh When The Saints Go Marching In
68. Oh You Beautiful Doll
69. Oh, Susanna
70. Old King Cole
71. Old MacDonald Had A Farm
72. Old Time Religion
73. One Day At A Time
74. One More River To Cross
75. Onward Christian Soldiers
76. Peace In The Valley
77. Precious Lord Take My Hand
78. Precious Memories
79. Rock Of Ages
80. Rock-A-My Soul
81. Silent Night
82. Sweet By And By
83. Sweet Hour Of Prayer
84. The Little Drummer Boy
85. The Lord's Prayer
86. The Old Rugged Cross
87. This Little Light Of Mine
88. Toda La Noche
89. Twelve Days Of Christmas
90. Twinkle Twinkle Little Star
91. We Gather Together
92. We Wish You A Merry Christmas
93. Wedding Song (There Is Love)
94. What A Friend We Have In Jesus
95. When Irish Eyes Are Smiling
96. When The Roll Is Called Up Yonder
97. While Shepherds Watched, Their Flocks
98. Whispering Hope
99. Ya Llego La Navidad
100. You're A Grand Old Flag

Any and all discs shown are for illustration only and may or may not represent the actual disc(s) included in this package

Features

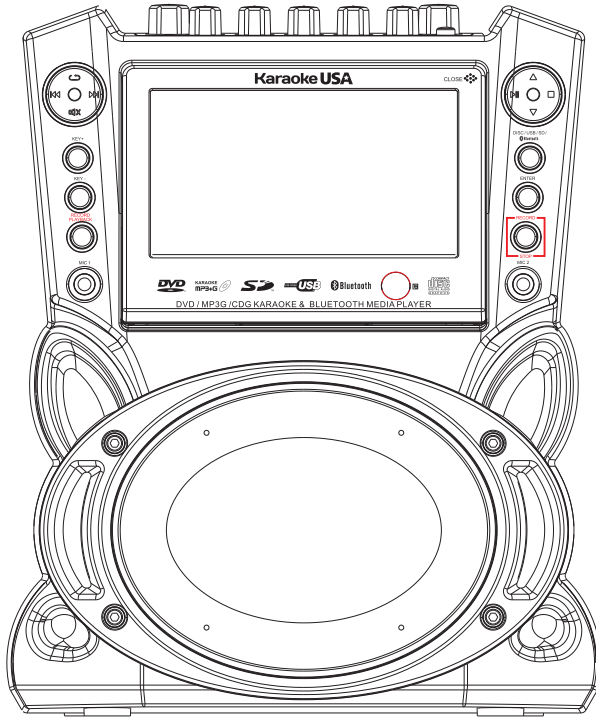

- DVD/CD+G/MP3+G Karaoke Player
- 7" TFT Color Screen
- Record CD+G/MP3+G Video/Audio mix
- Record and Record Instant Playback
- 35W Peak Power Output
- Remote Control
- 2 Microphones
- 2 Microphone Inputs and Holders
- USB/SD Card Slots (up to 128GB)
- USB Charger for Smart Device
- LED Lightings that Synchronize and Flash with the rhythm of Music
- Analog Echo Control
- Bluetooth wireless connection and Speaker
- Balance Control
- Digital Key Control
- Audio and Video Input
- Audio and Video Output
- Audio/Video RCA Cable
- 3.5mm to RCA Cable
- AC 100V~240V Adaptor
- DC 12V Car Adaptor (Optional)
**Can be ordered online: karaokeusa.com*

Front Panel Illustration

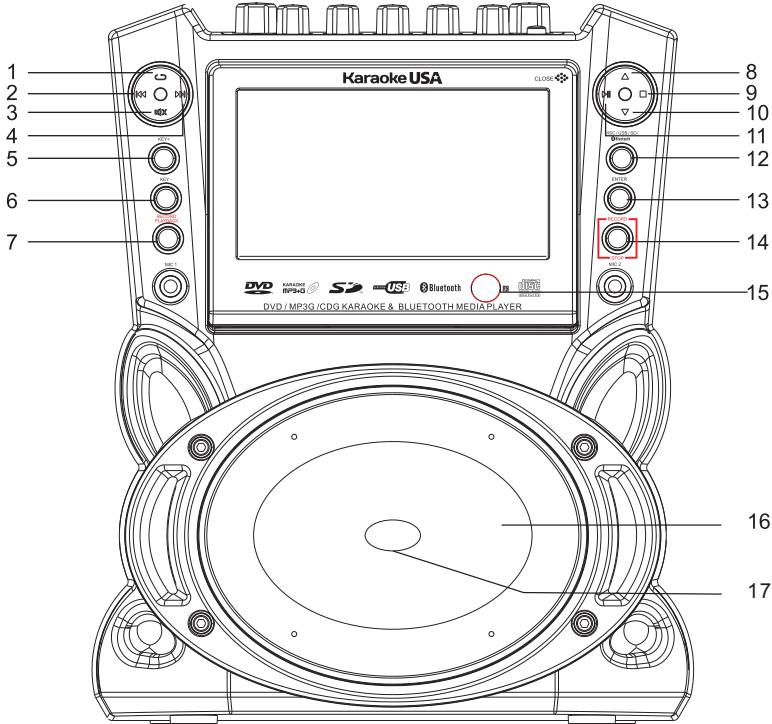

- 1. : Repeat the Song Playing
- 2. : PREVIOUS Song
- 3. : Mute the Audio Output
- 4. : Next Song
- 5. Key+ : Raise the Tone
- 6. Key- : Lower the Tone
- 7. Record Playback:
Playback the Recorded Track
- 8. : Navigate UP in the Menu
- 9. : Stop

- 10. : Navigate DOWN in the Menu
- 11. : Play or Pause
- 12. DISC/SD/USB/Bluetooth: Choose Content Source Disc, SD, USB or Bluetooth
- 13. Enter: Select a Menu Item
- 14. RECORD/STOP: Record Start & Stop
- 15. : Remote Control Infrared Receiver
- 16. Speaker: Audio Speaker
- 17. Flashing LED Lights

Top Panel Illustration

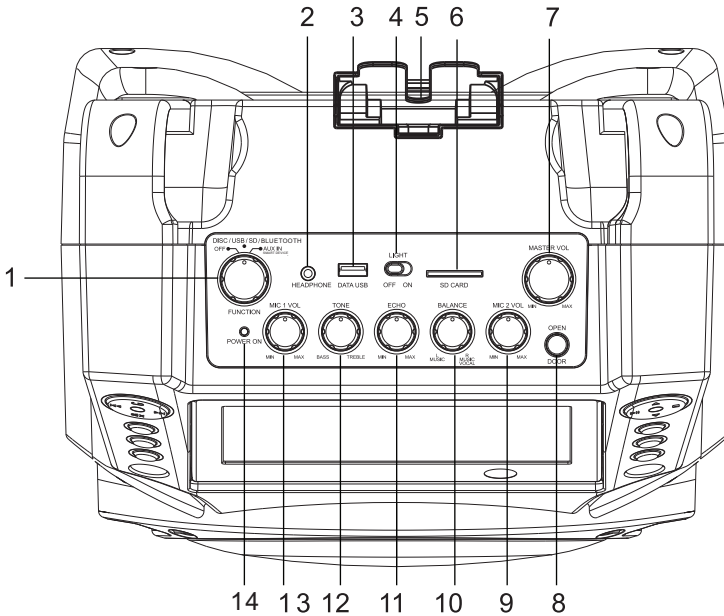

1. **POWER & FUNCTION:** Switch the player ON/OFF, Select Play mode in Disc, USB, SD,Bluetooth or AUX IN.
2. **HEADPHONE:** Standard 3.5mm headphone jack
3. **USB SLOT:** For playing / recording music and vocal mix
4. **LIGHT ON/OFF:** Flashing LED Lights ON/OFF Button
5. **CRADLE:** Removable Personal Player Cradle for holding Smart Devices and playing / charging
6. **SD CARD SLOT:** For playing/recording music and vocal mix
7. **MASTER VOL:** Master Volume Control
8. **CD DOOR OPEN BUTTON:** Open CD door
9. **MIC 2 VOL:** Volume Control for Microphone 2
10. **BALANCE:** Music only/music and vocal
11. **ECHO:** Add an echo effect to singer's voice
12. **TONE:** Adjust the Level of Treble and Bass
13. **MIC 1 VOL:** Volume Control for Microphone 1
14. **POWER LED:** Power ON/OFF indicator

Connecting to a TV Set

To watch lyrics on your TV screen, connect the yellow (video), red (audio) and white (audio) RCA ends into the matching color jacks on the TV. To view lyrics, you must select an input channel on your TV (Video1, Video 2 , Aux, etc.)

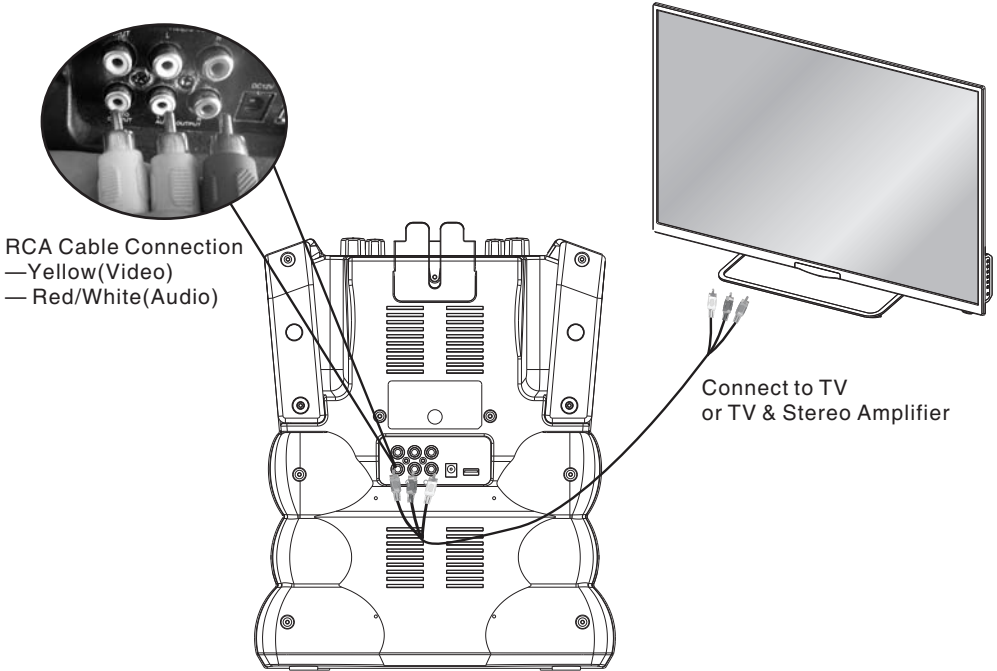

Smart Device Connection

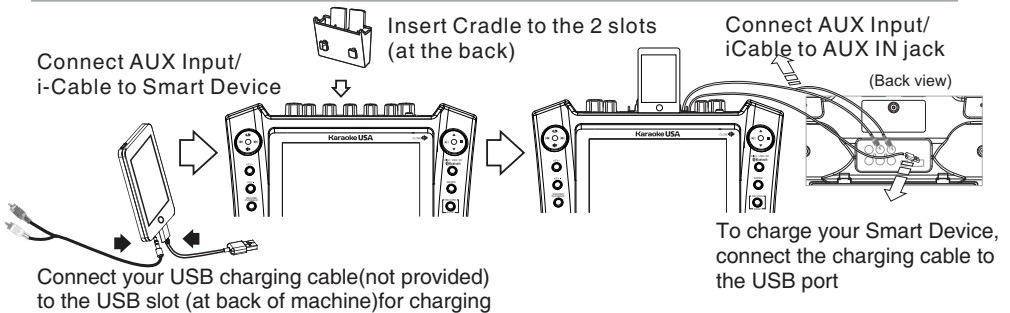

NOTES.

- 1.If connecting to a surround sound or enhanced sound system, you may have to temporarily disable the sound effect(s). Sound systems manipulate incoming audio to give you the desired sound effect. This effect may cause two unwanted results: the timing between the audio and lyrics displayed on screen, and an echo affect on the audio.
- 2.To play music from your Smart Device, connect your device's headphone jack to the machine 3.5mm AUX-IN jack, then select AUX IN mode on the machine. Audio will play on machine speaker. You will not see lyrics on the machine's screen from your device.

Remote Control

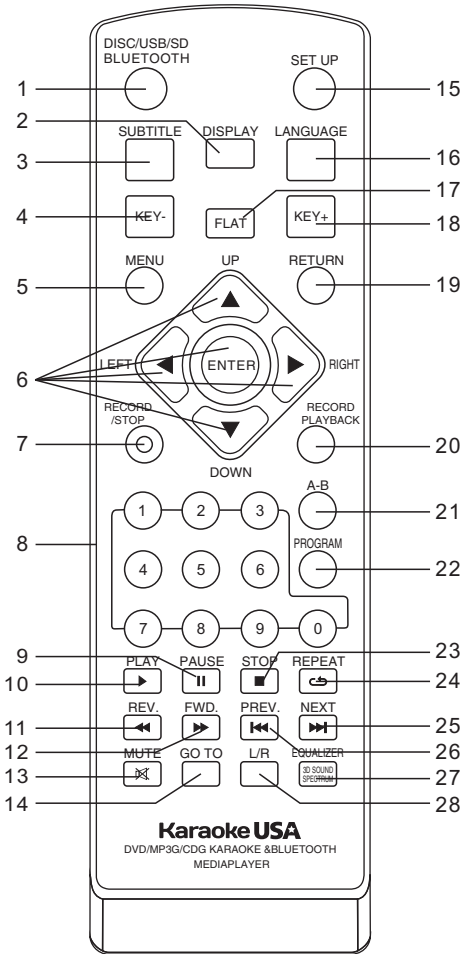

1. DISC/USB/SD/BLUETOOTH
2. DISPLAY
3. SUBTITLE
4. KEY-
5. MENU
6. UP/DOWN/LEFT/RIGHT/
ENTER BUTTON
7. RECORD/STOP
8. NUMBER KEYS
9. PAUSE
10. PLAY
11. REV.
12. FWD.
13. MUTE
14. GO TO
15. SET UP
16. LANGUAGE
17. FLAT
18. KEY+
19. RETURN
20. RECORD PLAYBACK
21. A-B
22. PROGRAM
23. STOP
24. REPEAT
25. NEXT
26. PREV.
27. EQUALIZER
28. L/R

NOTES:

1. In this Manual, the directional symbols “◀▶▲▼” are NAVIGATION ARROWS on the Remote Control.
2. To operate any of the Remote Control functions, you must press and enter the relevant DISC, SD, USB mode.

Remote Control Operation

1. **DISC/USB/SD
BLUETOOTH**  ● Press to change media in [DISC->USB->SD->BLUETOOTH]. Press and Select.



2. **DISPLAY**  ● During playback, press DISPLAY to show the current time counter position.

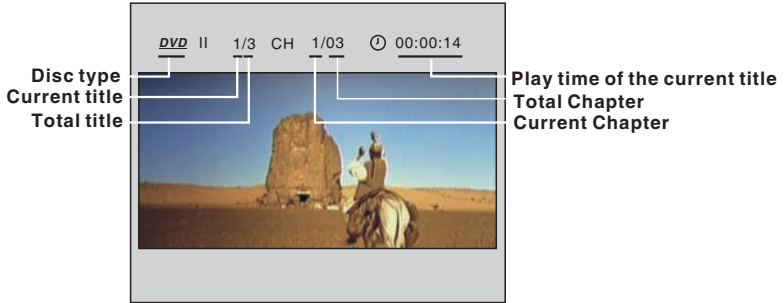



Press DISPLAY to show the audio and subtitle message menu.



3. **SUBTITLE**  ● Press to display the subtitles.
(Only applicable in movie, depends on your disc or your download file.)

4. **KEY-**  ● Transpose the music key down.

5. **MENU**  ● During DVD playback, press MENU to return to the program menu.
Note: This function is subject to the disc.

6.  ● Used for navigation within a selection menu.



7. **RECORD
/STOP**  ● Record your vocal and music to the USB or SD card.
(Note: USB or SD card must be inserted before start recording. DVD disc is not available for recording.)

Remote Control Operation

8.  ● Use to specify a track number for playing or programming.



9.  ● Press PAUSE during playback to pause.

10.  ● Press PLAY to start playing.

11.  ● During CD/DVD playback, keep pressing  to scan reverse. The player will review the disc at 2, 4, 8, 20 times and off normal speed as follows:



Press PLAY to resume normal playback.

12.  ● During CD/DVD playback, keep pressing  to scan forward. The player will review the disc at 2, 4, 8, 20 times and off normal speed as follows:



Press PLAY to resume normal playback.

13.  ● Press MUTE to cut the Audio output.
● Press MUTE again to resume normal Audio output.

14.  ● During playback, press GO TO show the current time counter position.

Enter number to choose the title

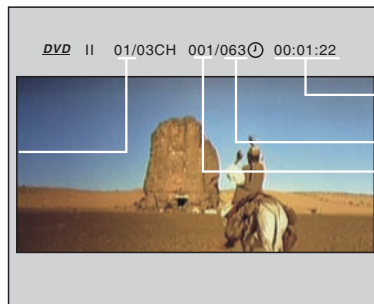

Enter number to choose the Play time
Total Chapter
Enter number to choose the chapter.





15.  ● Press to setup the TV settings according to your needs.

16.  ● To select the movie language.

17.  ● Set the music key as normal.

18.  ● Transpose the music key up.

Remote Control Operation



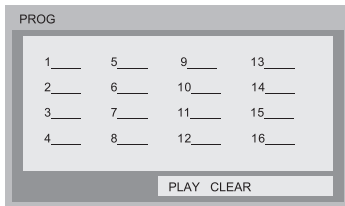

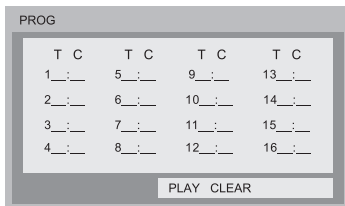

19. **RETURN**  ● Return to a Menu screen while playing.
20. **RECORD PLAYBACK**  ● Press this button to listen the music that you **JUST** recorded.
21. **A-B**  ● Press A-B first to set location A: REPEAT: A-, press again to set location B, and then playback will repeat during the two locations: REPEAT: A-B. Press A-B the third time to cancel the function and return to normal playback: REPEAT: CANCEL.
22. **PROGRAM**  ● This is the function provide you to listen the tracks in a desire order.
While [PROGRAM] is on, press ENTER to display the [Program submenu]:



Input the track numbers in the order you would like them to play. When you have finished, press PLAY then press ENTER to play the tracks in the new programmed order. Select CLEAR then press ENTER to clear all numbers



Input the title and chapter numbers in the desired order. Then press PLAY then press ENTER to play the chapters in the order you have set. Select CLEAR then press ENTER to clear all the numbers.

23. **STOP**  ● Press STOP once during playback to stop and hold playback.
● Press PLAY to resume playback from the point you pressed STOP.
● Press STOP twice to stop playback completely.
24. **REPEAT**  ● Press this key to play selected item repeatedly.
The screen shows as below:
REP: [OFF] REP: [REP1] REP: [REP ALL]
25. **NEXT**  ● Press NEXT to skip to next chapter or track.
26. **PREV.**  ● Press PREV. to skip to previous chapter or track.
27. **EQUALIZER**  ● This key is set the different sound effect of the music.
28. **L/R**  ● Activates the multiplex function, which switches to NORMAL (stereo), L-ch monaural and R-ch MONAURAL.

Remote Control Preparation

Battery installation

1. Open the Cover

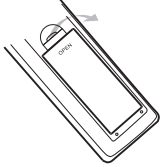

2. Install Batteries (AAA 1.5Vx2, not included)

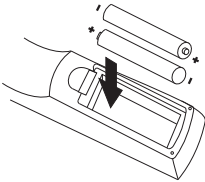

3. Close the Cover

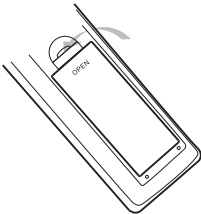

Using the Remote Control

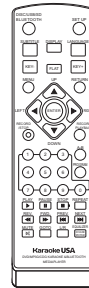
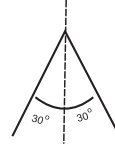
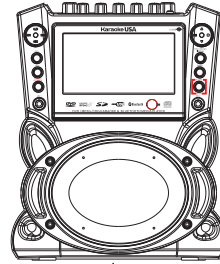

Notes:

- Point the Remote Control directly to the sensor of the machine.
- Do not leave the Remote Control in an extremely hot or humid place.
- Do not spill water or put anything wet on the Remote Control.
- When this machine will not be used for an extended period of time, please remove all Batteries from the Battery Compartment.

How to Play a Disc

Your GF846 will support CD, CDG, MP3, MP3G and DVD format disc.

1. Connect the AC adaptor to the unit;

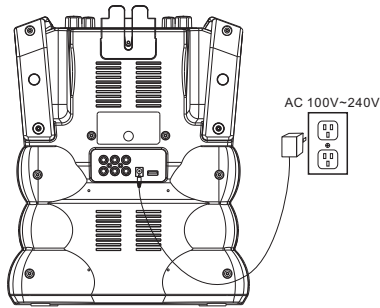

2. Load your disc;

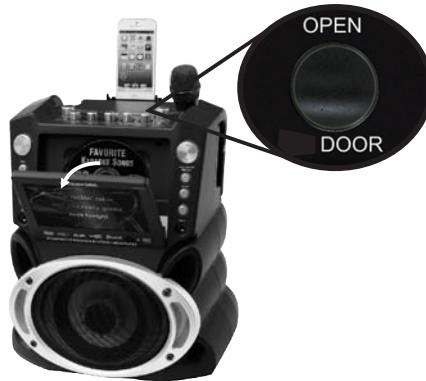

3. Close the CD door;



4. Turn on the unit (switch the machine to DISC/USB/SD/BLUETOOTH mode) and select the "DISC" mode, the power indicator will light up.

5. Press PLAY to start playing your Disc

MP3G Disc and MP3G Format Music Playback

When an MP3G Disc, SD Card or USB device is connected, the screen will display as follows:

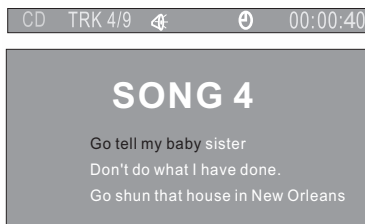
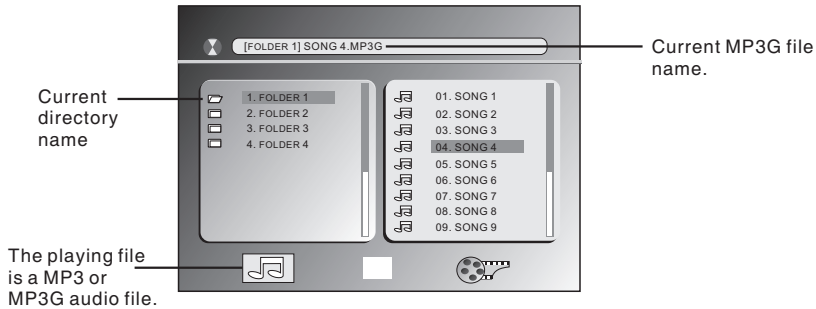

- Press ▲ ▼ to select the file when the cursor appears in the file window.
- Press PLAY to play the current file selected by the cursor.
- Press ◀ ▶ to switch between the directory window and the file window.

Notes: The machine will not function correctly under the following condition:

1. The disc is badly scratched, damaged or dirty.
2. The recording format is not supported by the player.

Play Bluetooth Music

1. Pairing your Smart Phone using Bluetooth :

- A. Power the machine ON and then select DISC/USB/SD/BLUETOOTH mode.
- B. Select Bluetooth mode with the DISC/USB/SD/BLUETOOTH button.

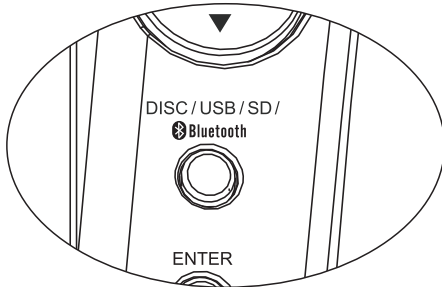

(on the Front Panel or on the Remote Control)

When in Bluetooth mode, the screen shows : "BLUETOOTH NO CONNECTION".

2. Setting your Smart Device to "explore" the unit.

- A. Activate your Bluetooth function on your smart device.
- B. Click "Setting" and select "Bluetooth"

3. Using your Smart Device to connect to the Machine

- A. Your Smart Device will Discover:GF846.
- B. Select GF846.
- C. To accept the pairing to your smart Device .
- D. If they are paired, the screen will show: "Bluetooth Connected" and you will hear a "beep" sound.
- E. If they are not paired, the screen will show : "BLUETOOTH NOT CONNECTION".
- F. Please repeat "Steps 1,2 & 3"above until they are paired.

4. Play Audio via Bluetooth After Pairing:

- A. Select the song files that you wish to play from your Smart Device.
- B. Then press "▶||" to start sending to the Machine by Bluetooth connection.
- C. Always remember to use full volume to send your song files from your smart device.
- D. Adjust the Master Volume on the Machine to a comfortable level when necessary.
- E. Music will be put "on Hold" automatically when your Smart Device receives a phone call to let you answer. The music will resume when you end the call.

5. Bluetooth transmits audio only. You will not see lyrics when using Bluetooth for a music source.

Play SD Card and USB

Play Music

Before you do this, make sure you have download the music(MP3,MP3G format) to your SD card or USB. Plug the SD card or USB to the machine, press “DISC/SD/USB/BLUETOOTH” to select your desire device, then the screen will shows:

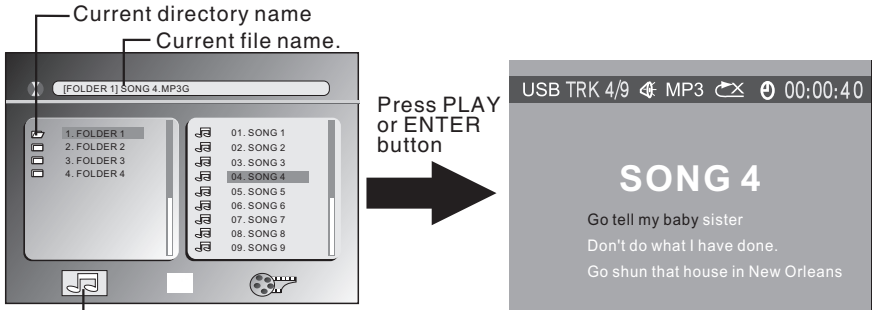

The frame shows it is in music mode.

Press ▼ ▲ to select the file when the cursor appears in the file window.
Press ENTER or PLAY to play the current file select by the cursor.
Press ◀ ▶ to switch between the directory window and the file window.

View Photo

Before you do this, make sure you have download the image(JPG.format) to your SD card or USB(The operation is same as “Play Music”). And the screen will show:

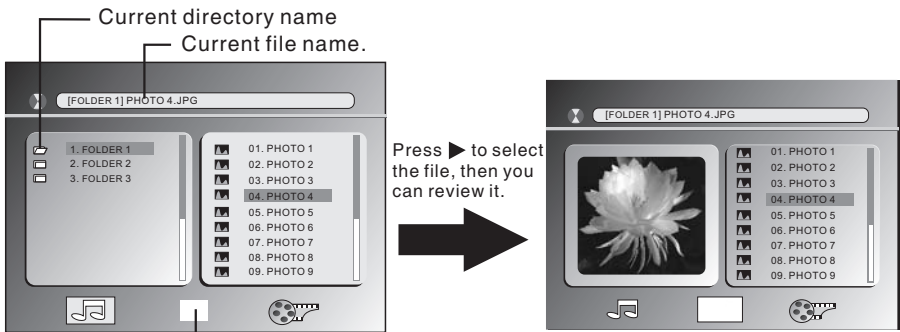

The frame shows it in photo mode.



Record Operation Procedures

Before recording - please read

1. Music source can be CD, CDG, MP3 or MP3G on a disc, USB stick or SD Card. Recordings cannot be made when using a DVD or AUX-in jack for a music source. If music source is USB stick or SD Card, recordings write to the same USB stick or SD Card.
2. Recordings can be written to USB stick or SD Card, not to disc. USB sticks and SD Cards should be formatted to FAT32 on your computer. Recordings can be erased by inserting USB stick or SD Card into your computer.
3. If both a USB stick and SD Card are inserted, the recording will always default to the USB stick. If a recording is required on the SD Card, you must remove the USB stick.
4. **Sing directly into the top of the microphone, not the side. (see right picture)**
The microphones are uni-directional to lessen ambient interference.
Sing loud and clear into top of microphone.



For best recording results

1. **Set Microphone volume to 70% or higher. The higher the Microphone volume, the louder the singer's voice will be on the recording. Recorded music volume is preset in the machine.**
2. Set the Master Volume to whatever level is comfortable.

Recording instructions

1. Load music source. If music source is a disc, also insert USB stick or SD Card.
2. Select song from menu and press play.
3. Press RECORD/STOP. Music will start over allowing singer to prepare.
4. When done singing, press RECORD/STOP to stop recording.
5. Press PLAYBACK to hear your recording.

When recording, the screen shows the below:

A. In MP3G mode

①. Playing

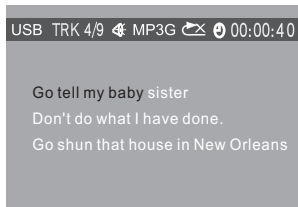

②. Recording

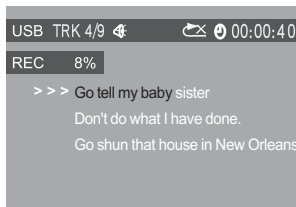

③. Recording finished



B. In CDG mode

①. Playing

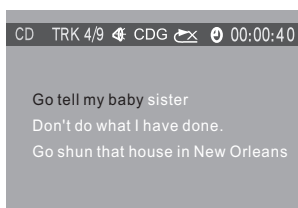

②. Recording

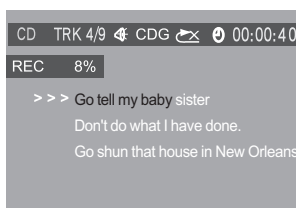

③. Recording finished

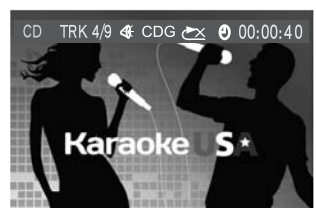

- ④. Press "RECORD PLAYBACK" to listen the song you just recorded.

Playback the Recorded File

To playback the current recorded file, just press "RECORD PLAYBACK" button once right after your recording. the last track will be played.

To playback the previous Recording

- A. Select RECORD folder, search for the track you wish to playback.
- B. The screen shows all track numbers, use the navigation buttons to pick the identical track number where the Song/Vocal was recorded.
- C. Then press ENTER to playback.

Note:

- 1. In order to enhance your vocal recording, slightly increase the Master Volume level, until you can hear your voice more obviously and comfortably.**
2. The Record function that this machine can provide is merely to record your karaoke entertainment events and experience for future listening and enjoyment.
3. The recording quality of this machine has been approved by most users from their positive reviews. However, we must stress that it may not please those very demanding users, nor it is fair to compare with the professional grade musical recordings and sound tracks being sold publicly in the open markets.

1. SYSTEM SETUP

The system setup options are illustrated as below:

1.1 TV SYSTEM

Using UP/DOWN arrow button to make a selection for TV system.

There are some TV output systems for choosen: NTSC ,PAL, AUTO.

1.2 SCREEN SAVER

The SCREEN SAVER function is always on; when the machine is in STOP mode, after few minutes in Open or No disc state, it will appear a DVD logo moving around the screen.

1.3 TV TYPE

According to the TV type, you can choose 16:9,4:3LB or 4:3 PS.

16:9 : The picture fills the screen of a wide screen TV.

4:3 PS: Pan and Scan, the image is cut in order to fit the whole screen.

4:3 LB: Letter box, two black bands will appear on the upper and lower part of the screen.

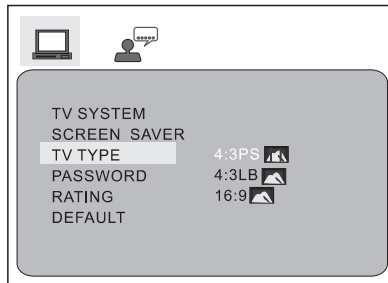

1.4 PASSWORD

The password option is initialized locked, and you can not set the ratings limit or change the password. In order to set the Ratings feature to work, the password mode must be turned on. If you want to set the rating limit, you will need to enter the default password. which is 0000,then press ENTER to confirm. To change the password, you will be prompted for the old password, then be prompted for a new one. Enter a 4-digit number (this is your password). Please remember your PASSWORD, as the DEFAULT setting will revert everything.

1.5 RATING

The Rating feature is a rating limit system, like movie ratings. it works with DVD discs that have been assigned a rating. This helps you control the types for DVDs that your family watches.

1.6 DEFAULT

The DEFAULT setup options are RESTORE factory setup.

When your machine does not work properly. It may probably result from some wrong setting. Please try the Restore Factory Setting function to see if the unit can restor to its normal working status.

2. LANGUAGE SETUP

The language setup options are illustrated as below:

2.1 OSD LANGUAGE

Highlight the OSD LANGUAGE option, and press the Arrow buttons to choose the OSD language you prefer. Press ENTER to confirm, then the language will be set as OSD language.

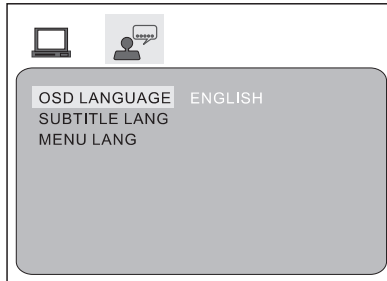

2.2 SUBTITLE LANG

Highlight the SUBTITLE LANG option, and press the Arrow buttons to choose the subtitle language you prefer. Press ENTER to confirm. If the disc you are playing has that language, it will display subtitles in that language.

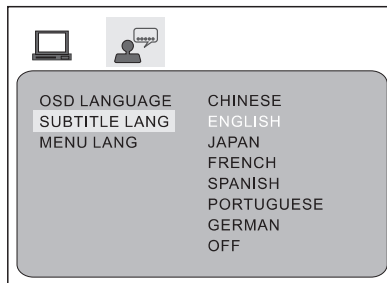

2.3 MENU LANG

Highlight the MENU LANG option, and press the Arrow buttons to choose the menu language you prefer. Press ENTER to confirm. If the disc you are playing has that language, it will display the menu in the language.

Notes: if your preferred language is not available, the disc default language will be played.

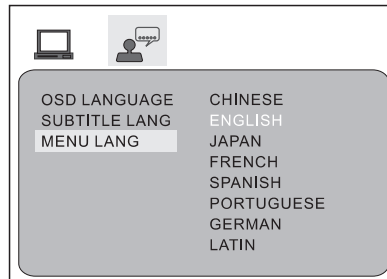

Specifications

Power requirements: DC 12V/2A

Power Consumption: 25 Watts

Video output

1.0 V(p-p) / 75 Ω ,sync, negative polarity

Audio output

2.0 channel output

Power output: 35W Peak Power

Frequency response :150HZ to 15KHZ

S/N ratio: >90 dB

Total harmonic distortion: <0.0025%

Accessories

AC Adapter x 1

RCA cables x 1

i-cable x 1

Remote Control x 1

User's Guide x 1

Warranty Card x 1

Holder for Smart Devices x 1

MP3G Demo Disc x 2

Microphone x 2

Troubleshooting

	Symptom	Possible Problem	Solution
General	No Power	Power outlet	Ensure all are connected firmly
		power adaptor	
		Power cord	
		Power switch on OFF position	Ensure the switch is in "ON" mode(on top)
	Powered but no respond	Needs reset	Turn off the unit then turn on again
Microphone	Volume too low	Microphone volume setting	Set the microphone volume higher especially when recording
TV Connection	No picture (or sound) on TV	RCA cable connect in the wrong way	Ensure the RCA cable connect to the correct AV input on your TV
		Wrong setting on your TV	Ensure TV setting on the proper channel (video 1, channel 1 etc.)
Play Disc	No picture displays on the unit	No disc	Put in a disc
		Disc stained, warped or scratched	Ensure the disc is in good condition
		Wrong disc type	The unit will plays DVD, CD, CD+G, MP3+G
		Unit set in AUX IN mode	Set the Function knob in DISC/USB/SD mode

Troubleshooting

	Symptom	Possible Problem	Solution
Play USB & SD	No read	No files or wrong format file on your USB & SD	Download the files to your device and try different format if necessary
	No record	USB or SD store memory is full	Delete some files to reserve some space for recording
	No function at all	wrong format or use too long time	Backup your files on your computer and format the USB or SD card
Play AUX IN	No music	AUX IN cable not connected properly	Ensure the AUX IN cable connect to the correct RCA input jack on the back
		Unit set in DISC/USB/SD mode	Set the Function knob in AUX IN mode
		The volume setting too low on your smart device and the unit	Set the volume higher on your smart device and the unit
Bluetooth	No pairing	In the wrong mode	Set the Function knob to DISC/USB/SD/ Bluetooth mode, and select the source button to Bluetooth mode.
	No music	Unit set in AUX IN mode, or no connection	Set the Function knob to DISC/USB/SD/ Bluetooth mode, and select the source button to Bluetooth mode, make sure the Bluetooth is connected
	Music too low	Volume setting too low on your smart device	Turn the volume up on your smart device and the unit volume,too

Notes on SD Card

SD CARD

- * Please use standardized SD Cards. poor quality SD Cards may cause Karaoke machine to malfunction.
- * Gently insert the SD Card with its label facing upwards.

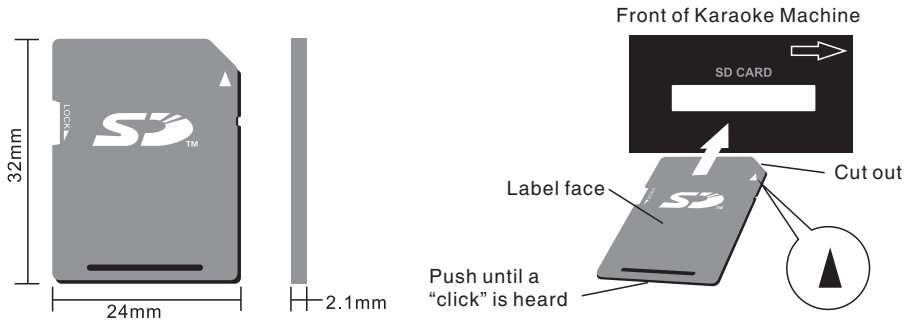

- * Compliant card type: SDHC Card, SD Card, miniSD Card, mini SDHC Card, microSD Card, microSDHC Card (requiring miniSD Card/miniSDHC Card/microSD Card/microSDHC Card adapter)
- * When any mini size SD Card or TF Card is used, firstly insert it to an Adaptor before application.

Karaoke USA

KARAOKE USA
1185 GOODEN CROSSING
LARGO, FL 33778 USA

TECH SUPPORT: WWW.KARAOKEUSA.COM/CS
DOWNLOAD SONGS: WWW.SINGTHEHITS.COM
SALES DEPARTMENT: SALES@KARAOKEUSA.COM