

# Home Complete

Cell Signal Booster

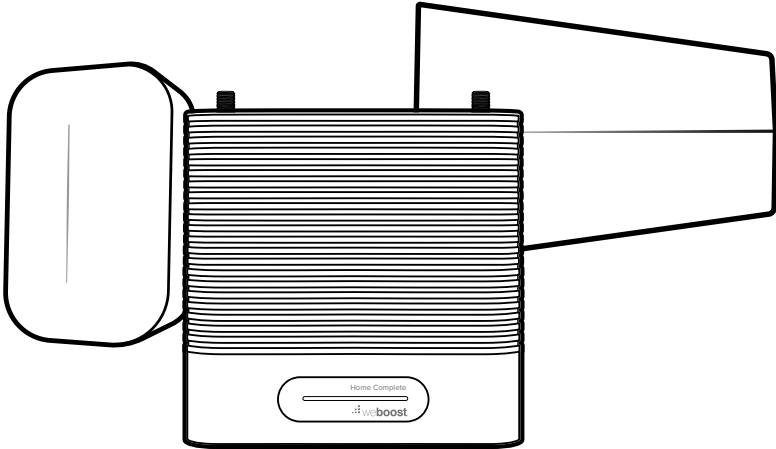

## Installation Guide

---

# Index

Package Contents .....	1
Preparation .....	2
<b>STEP 1:</b> Inside Antenna & Booster Placement .....	3
<b>STEP 2:</b> Mount & Point Outside Antenna Toward Nearest Cell Tower .....	5
<b>STEP 3:</b> Route & Connect Outside Antenna To Booster .....	8
<b>STEP 4:</b> Route & Connect Inside Antenna To Booster .....	9
<b>STEP 5:</b> Power Up The Booster & Optimize The System .....	10
Measuring Booster Performance .....	12
Light Patterns .....	14
Troubleshooting .....	15
Safety Guidelines .....	16
Specifications .....	18
Warranty .....	19

---

# Package Contents



Home Complete



Inside Antenna (314440)

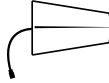

Outside Antenna (314445)



75' & 60' Cables (951160), (951175)



Power Supply (850030)



Outside Antenna Mounting Bracket



Wall Mount Brackets w/Command Strips



Cable Mounting Clips Qty. 15

---

# Preparation

## You Will Need (tools not included)

Make sure the following materials are prepared and ready for your installation.



1 to 2 hours



1 Person (2 people to make antenna calibration easier)



- Ladder
- Drill (*if routing cable through wall*)
- 1" - 3" diameter existing pole for mounting  
Outside Antenna (#901117 Pole Mount can be purchased separately if needed)
- Recommended: Power Strip with surge protection

NOTE: These instructions will walk you through a “soft” install process to find the optimal locations for the inside and outside antennas, then through the process of the permanent installation.

---

# Step 1: Inside Antenna & Booster Placement

Place the **inside antenna** where you need the greatest signal boost and place **booster** in your desired location at least **24"** away from inside antenna.

NOTE: Do not connect booster to power until the system is fully installed.

TIP: The cable from the inside antenna can be routed into the ceiling and connected to the coax cable out-of-sight for a better look.

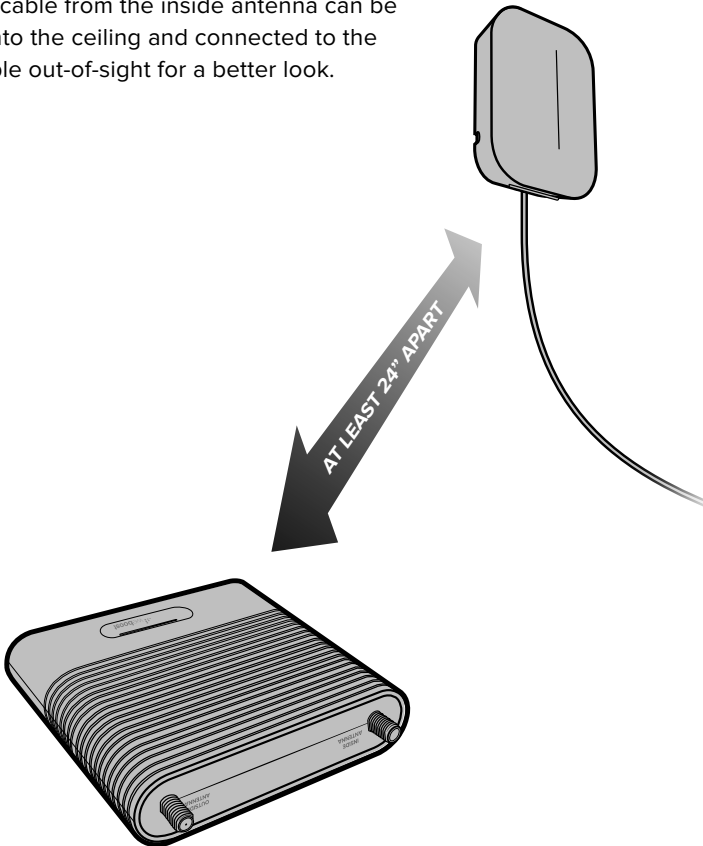

(STEP 1 cont.)

The inside antenna can be mounted horizontally, vertically or on a flat surface. Command strips can be used to secure mounting bracket.

### Inside Antenna Mounting Options

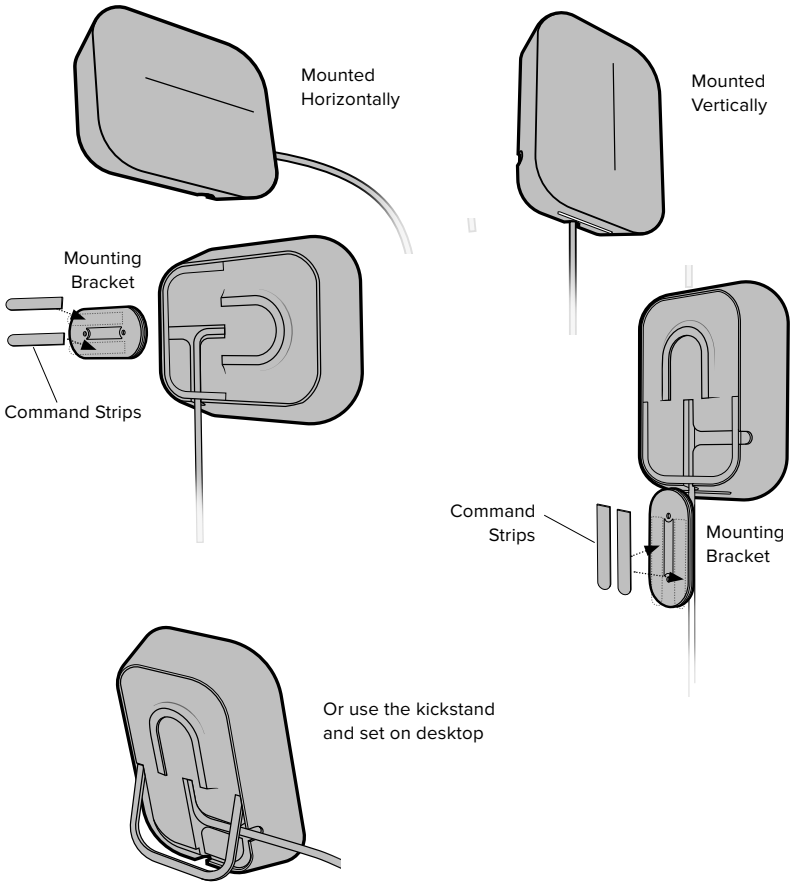

---

# Step 2: Mount & Point Outside Antenna Toward Nearest Cell Tower

**Pole mounting and wall mounting options are included.** The pole mounting option is preferred because it will be easier to adjust to the direction of the cell tower.

Attach the **mount** to the outside antenna and use the **bracket clamp** to attach the antenna to a pole or exhaust pipe.

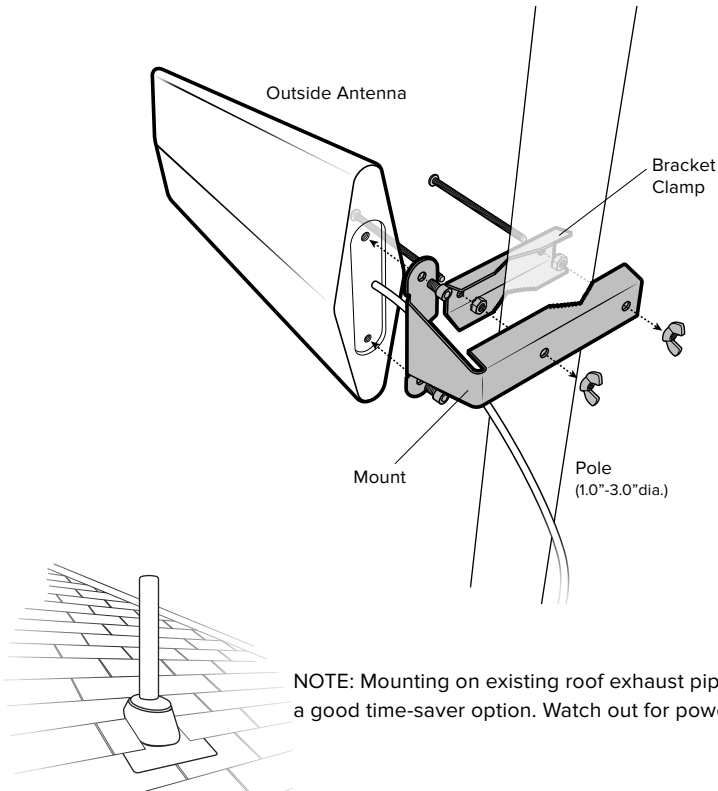

---

(STEP 2 cont.)

Point the **outside antenna** toward the nearest cell phone tower. To find the nearest tower, use an app such as 'Open Signal'. **This is the most critical step of the installation process because it will determine the overall performance of the booster's system.**

**The greater the separation between the inside and outside antennas, the better performance you will get from the booster.**

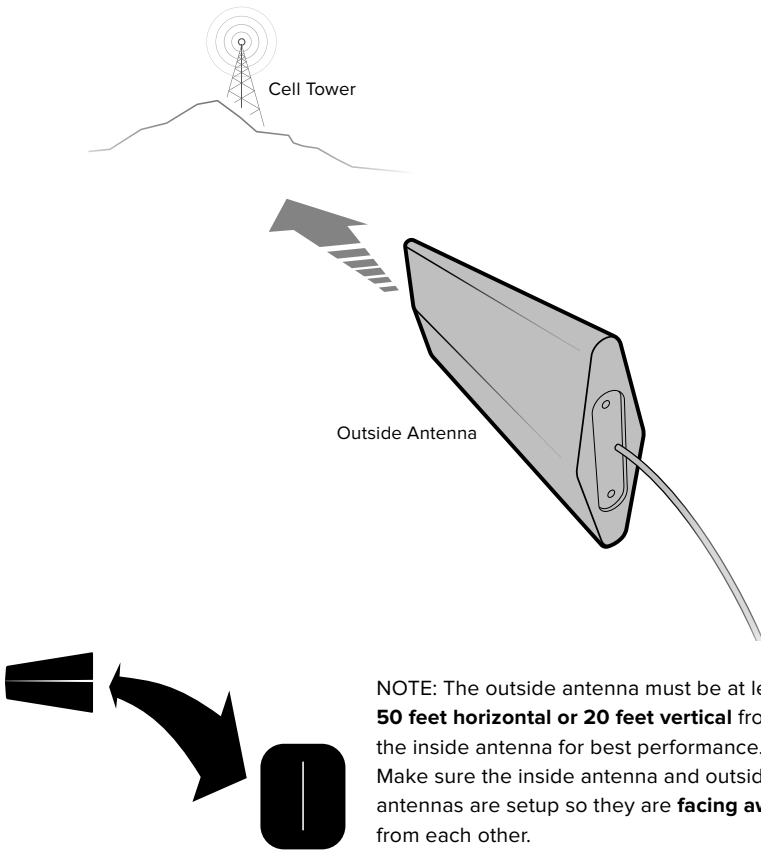



---

(STEP 2 cont.)

If there's not a pole to easily mount the outside antenna, this may be mounted on the fascia by fastening the bracket as shown below.

TIP: Make sure to do the optimization test on Step 5 to find the best side of your house before you mount this on the fascia.

### Mounting On Side Of Roof (Fascia)

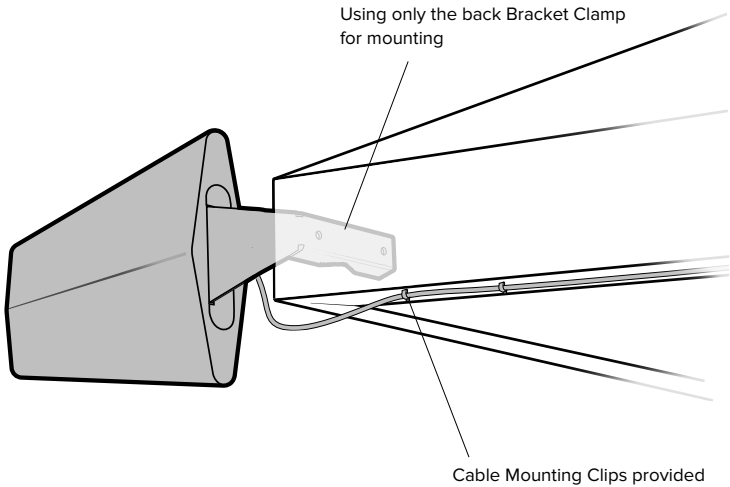

---

# Step 3: Route & Connect Outside Antenna To Booster

Connect the black **75 ft. coax cable** to **outside antenna** and route cable into the home. All connections should be **hand tightened** only.

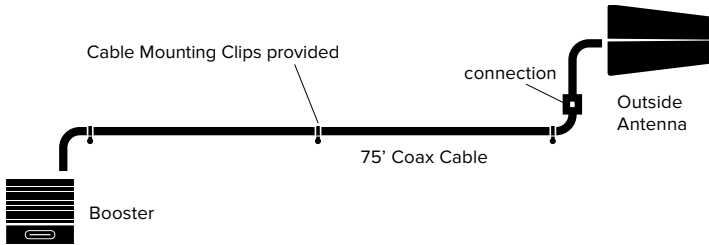

Route cable to the **Home Complete Booster** and connect to the port labeled 'OUTSIDE ANTENNA'.

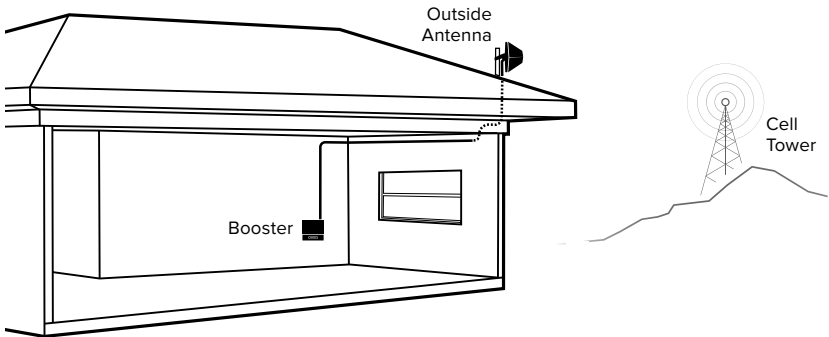

---

# Step 4: Route & Connect Inside Antenna To Booster

Connect the black **60 ft. coax cable** to inside antenna and route to the **Home Complete Booster** and connect to the port labeled 'INSIDE ANTENNA'.

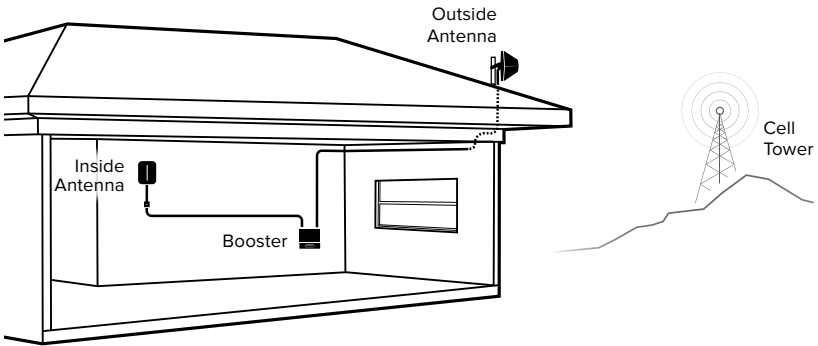
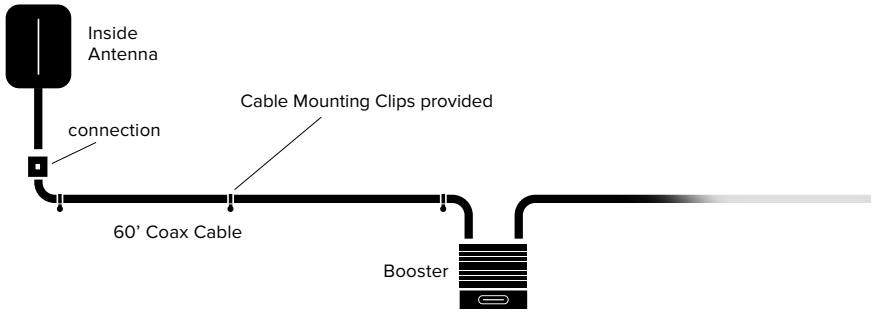

---

# Step 5: Power Up The Booster & Optimize The System

Plug the **power supply** into wall outlet then connect to end of booster labeled “”.

NOTE: We strongly recommend using a power strip with surge protection.

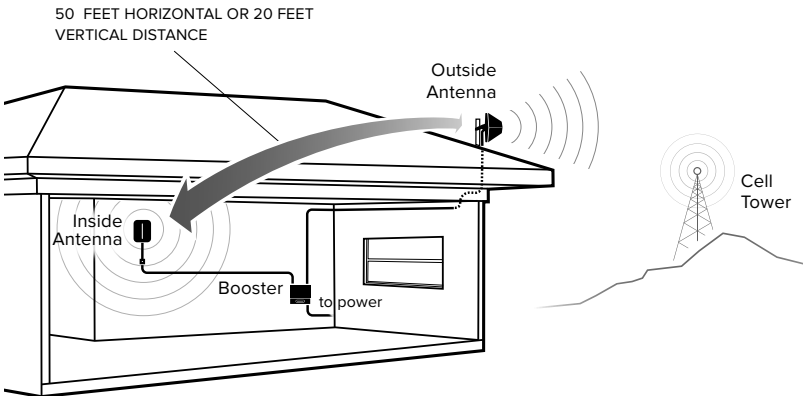
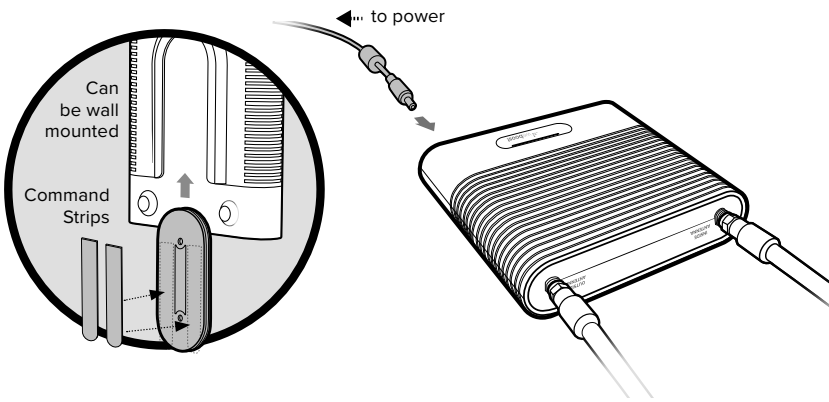

---

(STEP 5 cont.)

After powering up your system, you are now ready to optimize your system. Rotate the outside antenna in 1/8 turn increments, **after each turn, unplug and reconnect the booster to power while observing the signal level on your cell phone from the inside antenna's projected area.** Secure the outside antenna in place, pointing in the direction that gives you the strongest signal. Enjoy your boosted signal!

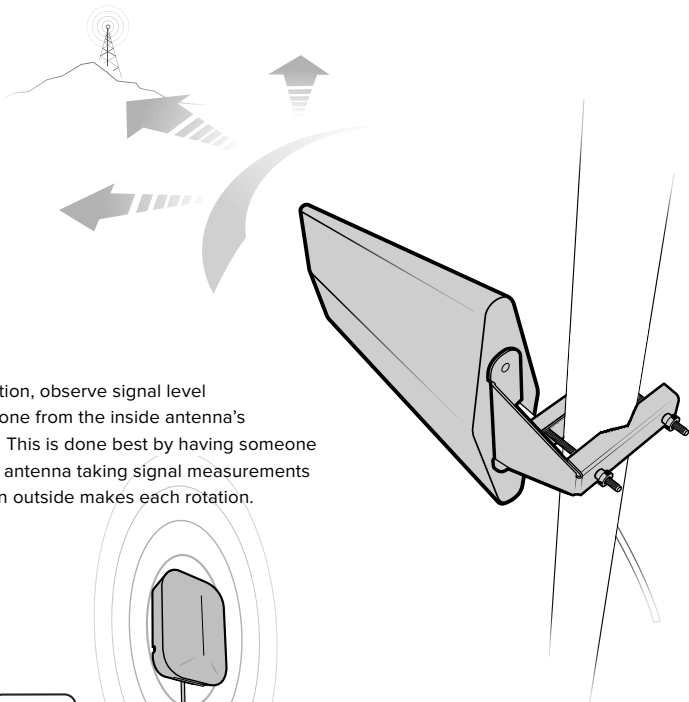

After each rotation, observe signal level on your cell phone from the inside antenna's projected area. This is done best by having someone near the inside antenna taking signal measurements after the person outside makes each rotation.

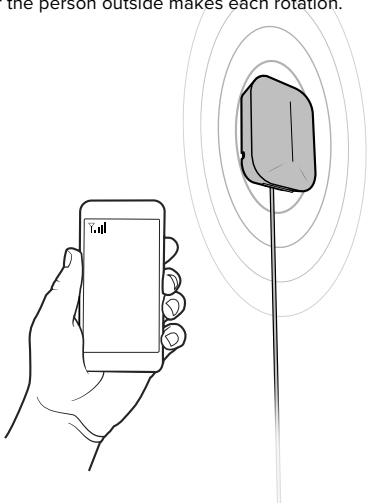

---

# Measuring Booster Performance

## How To Get Signal Strength As A Number

### **iPhone®**

iOS 11 and later no longer displays the decibel (dBm) reading in 'Field Test Mode'. Tip: Using the signal bars and performing data speed tests on your cell phone can assist you in finding the strongest signal direction as well as placing calls in different locations. **For changes/updates on this issue, periodically go to [weboost.com/signalstrength](http://www.weboost.com/signalstrength).**

### **Android™**

Settings > About Phone > Status or Network > Signal Strength or Network Type and Strength (exact options/wording depends on phone model).

iPhone is a registered trademark of Apple Inc. Android is a trademark of Google Inc.

## All Other Phones & Alternate Methods

Go to [www.weboost.com/test-mode-instructions/](http://www.weboost.com/test-mode-instructions/)

(MEASURING BOOSTER PERFORMANCE cont.)

## Signal Strength without Booster

Note here: \_\_\_\_\_

## Signal Strength with Booster

Note here: \_\_\_\_\_

## Compare Results

Having an accurate measurement of signal strength in decibels (dBm) is crucial when installing your system. Decibels accurately measure the signal strength you are receiving.

SIGNAL STRENGTH	EXCELLENT	GOOD	FAIR	POOR	DEAD ZONE
3G/1x	-70dBm	-71 to -85dBm	-86 to -100dBm	-101 to -109dBm	-110dBm
4G/LTE	-90dBm	-91 to -105dBm	-106 to -110dBm	-111 to -119dBm	-120dBm

**DID YOU KNOW** a signal increase of just 3dB is 2 times the power and signal amplification!

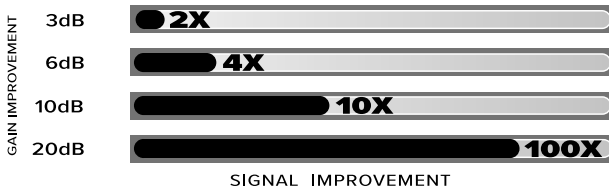

---

# Light Patterns

## Solid Green

This indicates that your booster is functioning properly and there are no issues with installation.

## Blinking Green & Red

Band has reduced gain. This indicates that one or more of the booster bands has reduced gain due to a feedback

loop condition called oscillation. This is a built in safety feature to prevent harmful interference with a nearby cell tower. If you are already experiencing the desired signal boost, then no further adjustments are necessary. If you are not experiencing the desired boost in coverage then refer to the Troubleshooting.

## Solid Red

Band has shutoff. This is due to a feedback loop condition called oscillation. This is a built in safety feature that causes a band to shut off to prevent harmful interference with a nearby cell tower. Refer to Troubleshooting.

## Blinking Green & Yellow

Band has reduced gain. This is a built-in safety feature to prevent harmful interference with a nearby cell tower. If you are already experiencing the desired signal boost, then no further adjustments are necessary. If you are not experiencing the desired boost in coverage, then refer to Troubleshooting.

## Solid Yellow

Band has shutoff due to overload from nearby cell tower. Outside antenna must be adjusted. Refer to Troubleshooting.

## Light Off

If the signal booster's light is off, verify your power supply has power.

Booster lights

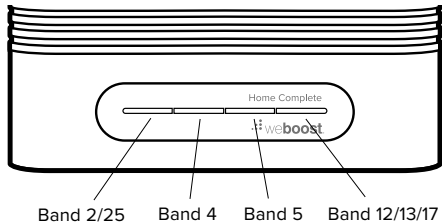



---

# Troubleshooting

**IF YOU ARE HAPPY WITH THE COVERAGE, THESE LIGHT ISSUES DON'T HAVE TO BE RESOLVED. YOUR CARRIER'S BAND HAS NOT BEEN AFFECTED.**

## FIXING ANY RED LIGHT ISSUES

This involves Solid Red & Blinking Green/Red lights.

- 1 Verify outside and inside antenna face away from each other. Unplug and replug in power supply.
- 2 Verify the inside antenna is at least 24" from the booster and pointed away from the booster. Unplug and replug in power supply.
- 3 Tighten all cable connections (be sure to hand tighten only, do NOT use tools). You may want to undo and redo the connection completely. Unplug and replug in power supply.
- 4 Increase the distance (horizontally or vertically) between the outside and inside antenna. Add included cable if needed. Unplug and replug in power supply.

## FIXING ANY YELLOW LIGHT ISSUES

This involves Solid Yellow & Blinking Green/Yellow lights.

**Outside antenna must be adjusted.** Wait 10 seconds between adjustments and unplug and replug for the lights to reset.

**Pole Mount Option:** Rotate the outside antenna away from the strongest cellular signal in small increments (1/4 turn) until the light turns green. Unplug and replug in power supply.

**Mounting on Side of Roof Option:** Change mount location. Move the outside antenna to a new location of the home/building to see if the lights turn green. Unplug and replug in power supply. Then secure in place.

---

**NEED HELP?**



support.weboost.com



866.294.1660

---

# Safety Guidelines

Use only the power supply provided in this package. Use of a non-weBoost power supply may damage your equipment.

The signal booster unit is designed for use in an indoor, temperature-controlled environment (less than 100 degrees Fahrenheit). It is not intended for use in attics or similar locations subject to temperatures in excess of that range.

**RF Safety Warning:** Any antenna used with this device must be located at least 8 inches from all persons.

**AWS Warning:** The outside antenna must be installed no higher than 10 meters (31'9") above ground.

## This is a CONSUMER device.

---

**BEFORE USE**, you **MUST REGISTER THIS DEVICE** with your wireless provider and have your provider's consent. Most wireless providers consent to the use of signal boosters. Some providers may not consent to the use of this device on their network. If you are unsure, contact your provider.

You **MUST** operate this device with approved antennas and cables as specified by the manufacturer. Antennas **MUST** be installed at least 20 cm (8 inches) from any person.

You **MUST** cease operating this device immediately if requested by the FCC or licensed wireless service provider.

**WARNING.** E911 location information may not be provided or may be inaccurate for calls served by using this device.

This device may be operated **ONLY** in a fixed location for in-building use.

## FOR MORE INFORMATION ON REGISTERING YOUR SIGNAL BOOSTER WITH YOUR WIRELESS PROVIDER, PLEASE SEE BELOW:

**T-Mobile/Sprint/MetroPCS:** <https://www.t-mobile.com/support/coverage/register-a-signal-booster>

**Verizon Wireless:** <https://www.verizon.com/solutions-and-services/accessories/register-signal-booster/>

**AT&T:** <https://securec45.securewebsession.com/attsignalbooster.com/>

**UScellular:** <https://www.uscellular.com/support/fcc-booster-registration>

# Antenna Kit Options

The following accessories are certified by the FCC to be used with the Home Complete Booster.

	BAND 12/17	BAND 13	BAND 5	BAND 4	BAND 25/2
Outside antenna maximum permissible antenna gain (dBi) 50Ω	4.4	4.2	3.9	4.4	4.6
Inside antenna maximum permissible antenna gain (dBi) 50Ω	3.2	3.0	3.2	2.4	2.5

## FIXED INSIDE ANTENNA KIT OPTIONS

Kit #	Coax Type	Ln(ft)	Antenna Type	Ω
304419	RG-11	30	Dome	75
301211	RG-11	30	Panel	75
314440	RG-11	30	Panel	75
314444	RG-11	30	Panel	75

## FIXED OUTSIDE ANTENNA KIT OPTIONS

Kit #	Coax Type	Ln(ft)	Antenna Type	Ω
314445	RG-11	30	Directional	75
314475	RG-11	30	Directional	75
304423	RG-11	30	Omni	75
304421	RG-11	30	Omni	75
314473	RG-11	30	Panel	75

# Specifications

Home Complete™					
Model Number	460060				
FCC ID	PWO460060				
Connectors	F-Female				
Antenna Impedance	75 Ohms				
Frequency	698-716 MHz, 729-746 MHz, 777-787 MHz, 824-894 MHz, 1850-1995 MHz, 1710-1755/2110-2155 MHz				
Power output for single cell phone (Uplink) dBm	700 MHz Band12/17	700 MHz Band13	800 MHz Band 5	1700 MHz Band 4	1900 MHz Band 25/2
	25.6	25.2	25.8	25.2	25.2
Power output for single cell phone (Downlink) dBm	700 MHz Band12/17	700 MHz Band13	800 MHz Band 5	2100 MHz Band 4	1900 MHz Band 25/2
	13.6	13.3	12.7	12.9	12.5
Noise Figure	5 dB nominal				
Isolation	> 110 dB				
Power Requirements	5 VDC				

Each Signal Booster is individually tested and factory set to ensure FCC compliance. The Signal Booster cannot be adjusted without factory reprogramming or disabling the hardware. The Signal Booster will amplify, but not alter incoming and outgoing signals in order to increase coverage of authorized frequency bands only. If the Signal Booster is not in use for five minutes, it will reduce gain until a signal is detected. If a detected signal is too high in a frequency band, or if the Signal Booster detects an oscillation, the Signal Booster will automatically turn the power off on that band. For a detected oscillation the Signal Booster will automatically resume normal operation after a minimum of 1 minute. After 5 (five) such automatic restarts, any problematic bands are permanently shut off until the Signal Booster has been manually restarted by momentarily removing power from the Signal Booster. Noise power, gain, and linearity are maintained by the Signal Booster's microprocessor.

This device complies with Part 15 of FCC rules. Operation is subject to two conditions: (1) This device may not cause harmful interference, and (2) this device must accept any interference received, including interference that may cause undesired operation. Changes or modifications not expressly approved by weBoost could void the authority to operate this equipment.

**NEED HELP?**



support.weboost.com



866.294.1660



## 2 YEAR WARRANTY

weBoost Signal Boosters are warranted for two (2) years against defects in workmanship and/or materials. Warranty cases may be resolved by returning the product directly to the reseller with a dated proof of purchase.

Signal Boosters may also be returned directly to the manufacturer at the consumer's expense, with a dated proof of purchase and a Returned Material Authorization (RMA) number supplied by weBoost. weBoost shall, at its option, either repair or replace the product.

This warranty does not apply to any Signal Boosters determined by weBoost to have been subjected to misuse, abuse, neglect, or mishandling that alters or damages physical or electronic properties.

Replacement products may include refurbished weBoost products that have been recertified to conform with product specifications.

RMA numbers may be obtained by contacting Customer Support

**DISCLAIMER:** The information provided by weBoost is believed to be complete and accurate. However, no responsibility is assumed by weBoost for any business or personal losses arising from its use, or for any infringements of patents or other rights of third parties that may result from its use.







3301 East Deseret Drive, St. George, UT

 866.294.1660  [www.weboost.com](http://www.weboost.com)  [support.weboost.com](mailto:support.weboost.com)

Copyright © 2019 weBoost. All rights reserved.

weBoost products covered by U.S. patent(s) and pending application(s)

For patents go to: [weboost.com/us/patents](http://weboost.com/us/patents)