



Accessories for the Range



Your Appliance Connection Solution®



6" 4-Turn 1,500-Watt Replacement Range Surface Burner Element

for Whirlpool®, Kenmore®, Frigidaire® & Maytag® MP15YA

51005 | UPC: 086844510059

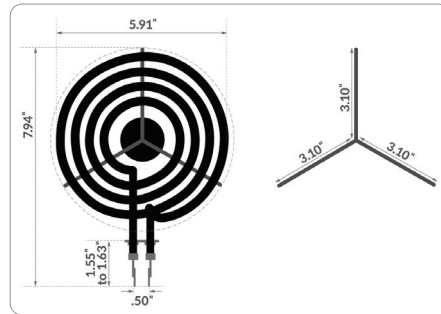
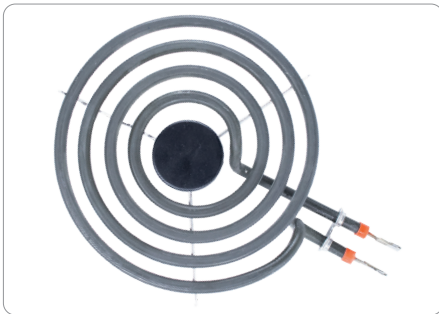

DESCRIPTION:

For years, licensed plumbers, electricians and appliance installers have relied on the Certified Appliance Accessories brand for their power cords, hoses and connectors. Now you can too. In addition to reliable and durable connectivity solutions, Certified Appliance Accessories carries high-quality replacement parts for electric ranges. The 6 in. 4 Turn 1,500 Watt Replacement Surface Range Burner Element is a quality product specifically designed for electric ranges found in homes and apartments. This surface element is an easy and convenient way to replace the existing cooking element on top of a stove or range. It has been thoroughly tested and is backed by a 5-year limited warranty. Check your appliance's manual for the correct specifications to ensure this is the surface element for you. Thank you for choosing Certified Appliance Accessories—Your Appliance Connection Solution.

Package Dimensions:

- Width: 6.6 in.
- Height: 2.3 in.
- Length: 8.4 in.
- Weight: 0.75 lbs.

Shippable to: US, Canada and Mexico

Warranty: 5-year warranty

FEATURES:

- Meets or exceeds industry certification standards & requirements of most appliance manufacturers
- Directly replaces a single 6" 4-turn MP15YA surface element
- For electric stove, electric cooktop or electric range only
- Fits most Whirlpool®, Kenmore® (2004+), Frigidaire®, Maytag®, Electrolux®, Tappan®, Amana®, Crosley® & RCA® electric ranges
- Not compatible with most GE®, Hotpoint® or Kenmore® (1995 to 2003) ranges
- Cooled element is easy to clean using only a soft sponge or cloth & warm water with mild soap solution, then wipe dry
- UL® listed

PACKAGE CONTAINS:

- 6" diameter surface burner element with 4 turns (single coil spun to create a spiral heating element with 4 rings)

