

GARMIN®

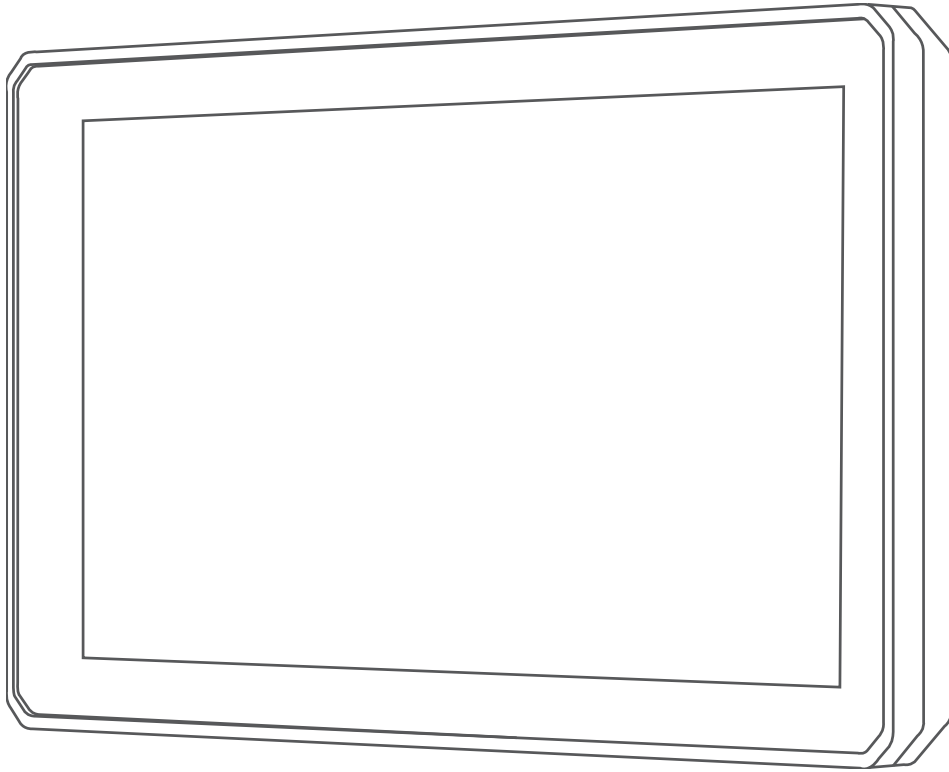

TREAD™

Owner's Manual

© 2020 Garmin Ltd. or its subsidiaries

All rights reserved. Under the copyright laws, this manual may not be copied, in whole or in part, without the written consent of Garmin. Garmin reserves the right to change or improve its products and to make changes in the content of this manual without obligation to notify any person or organization of such changes or improvements. Go to www.garmin.com for current updates and supplemental information concerning the use of this product.

Garmin®, the Garmin logo, inReach®, and TracBack® are trademarks of Garmin Ltd. or its subsidiaries, registered in the USA and other countries. BaseCamp™, Garmin Adventurous Routing™, Garmin Drive™, Garmin Explore™, Garmin Express™, Garmin PowerSwitch™, myTrends™, and Tread™ are trademarks of Garmin Ltd. or its subsidiaries. These trademarks may not be used without the express permission of Garmin.

Android™ is a trademark of Google Inc. Apple® and Mac® are trademarks of Apple Inc., registered in the U.S. and other countries. The BLUETOOTH® word mark and logos are owned by the Bluetooth SIG, Inc., and any use of such name by Garmin is under license. Foursquare® is a trademark of Foursquare Labs, Inc. in the U.S. and in other countries. HISTORY® and the H logo are trademarks of A+E Networks and are protected in the United States and other countries around the globe. All Rights Reserved. Used with Permission. iOverlander™ is a trademark of iOverlander. microSD® and the microSD logo are trademarks of SD-3C, LLC. Tripadvisor® is a registered trademark of Tripadvisor LLC. Windows® is a registered trademark of Microsoft Corporation in the United States and other countries. Wi-Fi® is a registered trademark of Wi-Fi Alliance. Other trademarks and trade names are those of their respective owners.

Table of Contents

Getting Started..... 1

Device Overview.....	1
Turning the Device On or Off.....	1
Acquiring GPS Signals.....	2
Status Bar Icons.....	2
Using the On-Screen Buttons.....	2
Adjusting the Volume.....	3
Using the Audio Mixer.....	3
Adjusting the Screen Brightness.....	3
Vehicle Profiles.....	3
Adding a Vehicle Profile.....	4
Choosing a Vehicle Profile.....	4

Installation..... 4

Mounting Your Device in an ATV or Side-by-Side.....	4
Power Cable Overview.....	4
Mounting Considerations.....	4
Mounting the Device on a Roll Bar.....	5
Mounting the Antenna.....	6
Installing the Antenna on the Group Ride Mount.....	7
Installing the Fist Microphone and Mount.....	8
Removing Your Device from the Mount.....	9
Replacing the Trim Ring.....	9

Off-Road Navigation Features..... 10

Routes.....	10
Straight Line Routes.....	10
Skipping the Next Stop on Your Route.....	10
Stopping the Route.....	10
Tracks.....	11
Recording Tracks.....	11
Navigating a Track.....	11
Viewing Your Collections on the Map.....	11
Pitch and Roll.....	11
Calibrating Pitch and Roll.....	11
Adjusting Warning Angles.....	12
Enabling or Disabling Warning Angle Alerts.....	12

Viewing the Altimeter, Barometer, and Compass.....	12
Calibrating the Compass.....	12
Group Ride.....	12
Starting a Group Ride.....	12
Joining a Group Ride.....	13
Rejoining a Recent Group Ride.....	13
Adding Riders to a Group Ride.....	13
Broadcasting a Message.....	13
Broadcasting a Location.....	13
Viewing a Group Ride Notification..	14
Exiting a Group Ride.....	14
Group Ride Settings.....	14
Radio.....	14
Selecting a Preset.....	14
Selecting a Radio Channel.....	14
Adjusting the Squelch.....	15
Adding a Custom Radio Preset.....	15
Selecting a Roger Tone.....	15
Turning the Radio Off.....	15
Enabling Push-to-Talk with a Headset.....	15
Transmitting Your Voice.....	15
Adjusting the Radio Volume.....	16
Radio Settings.....	16
inReach® Remote.....	16
Connecting an inReach Device.....	16
Sending an inReach Message.....	16
SOS.....	16

Using the Map..... 17

Map Tools.....	18
Viewing a Map Tool.....	18
Up Ahead.....	18
Viewing Upcoming Locations.....	18
Customizing the Up Ahead Categories.....	19
Cities Ahead.....	19
Viewing Upcoming Cities and Exit Services.....	19
Trip Information.....	19
Viewing Trip Data from the Map.....	19
Viewing the Trip Information Page..	19
Resetting Trip Information.....	20
Viewing Upcoming Elevation Changes.....	20
Viewing Upcoming Traffic.....	20

- Viewing Traffic on the Map..... 20
- Searching for Traffic Incidents..... 20
- Customizing the Map..... 20
 - Customizing the Map Layers..... 20
 - Enabling Adventure Roads and Trails
Map Layers..... 21
 - Changing the Map Data Field..... 21
 - Changing the Map Buttons..... 21
 - Changing the Map Perspective..... 21

- Assigning a Switch to a Control
Input..... 28
- Adding a Custom Layout..... 28
- Routines..... 29
- Dog Tracking..... 30
 - Receiving Data From Your Handheld
Device..... 30
 - Tracking Your Dogs..... 30
 - Viewing Your Dogs on the Map..... 31

Using the Apps..... 21

- Viewing the Owner's Manual on
Your Device..... 21
- Music Player..... 21
 - Adding the Music Player Tool to the
Map..... 22
 - Changing the Media Source..... 22
- BirdsEye Imagery..... 22
 - Downloading BirdsEye Imagery..... 22
- Trip Planner..... 22
 - Planning a Trip..... 23
 - Editing and Reordering Locations in a
Trip..... 23
 - Discovering Attractions Along Your
Trip..... 23
 - Changing Routing Options for a
Trip..... 23
 - Changing Transportation Modes in a
Trip..... 24
 - Navigating to a Saved Trip..... 24
- Sharing a Route..... 24
- TracBack®..... 24
 - Following Your Recent Track..... 24
 - Saving Your Recent Track as a
Trip..... 24
- Viewing the Weather Forecast..... 25
 - Viewing Weather Near a Different
City..... 25
 - Viewing the Weather Radar..... 25
 - Viewing Weather Alerts..... 25
 - Checking Road Conditions..... 25
- Creating a Round-Trip Route..... 26
- Viewing Previous Routes and
Destinations..... 26
- Garmin PowerSwitch™ App..... 27
 - Activating a Power Switch..... 27
 - Turning Off All Switches..... 27
 - Customizing a Button..... 28

Live Services, Traffic, and Smartphone Features..... 31

- Bluetooth Feature Status Icons..... 32
- Pairing Your Phone and Headset..... 32
- Smart Notifications..... 32
 - Receiving Notifications..... 33
 - Viewing the List of Notifications..... 34
- Hands-Free Calling..... 34
 - Placing a Call..... 34
 - Placing a Call Using Voice Dial..... 34
 - Using In-Call Options..... 34
- Setting Up Bluetooth Features for Your
Apple® Device..... 35
 - Disabling Bluetooth Features
(iPhone®)..... 35
- Setting Up Bluetooth Features for Your
Smartphone with Android™..... 35
 - Disabling Bluetooth Features
(Android)..... 35
- Enabling or Disabling Bluetooth Features
for Your Headset..... 35
- Disconnecting a Bluetooth Device..... 35
- Deleting a Paired Phone..... 35

Street Navigation..... 36

- Starting a Route..... 36
 - Starting a Route by Using the Map.. 36
- Your Route on the Map..... 37
 - Active Lane Guidance..... 38
 - Viewing Turns and Directions..... 38
 - Viewing the Entire Route on the
Map..... 38
- Changing Your Active Route..... 38
 - Adding a Location to Your Route..... 38
 - Shaping Your Route..... 39
- Avoiding Delays, Tolls, and Areas..... 39

Avoiding Traffic Delays on Your Route.....	39	Finding Ultimate Campgrounds Points of Interest.....	48
Avoiding Toll Roads.....	39	Finding iOverlander™ Points of Interest.....	48
Avoiding Toll Stickers.....	40	Finding Powersport Points of Interest.....	48
Avoiding Road Features.....	40	Tripadvisor.....	48
Custom Avoidances.....	40	Finding Tripadvisor Points of Interest.....	48
Arriving at Your Destination.....	41	Viewing Recently Found Locations.....	49
Changing the Route Calculation Mode.....	41	Clearing the List of Recently Found Locations.....	49
Taking a Route Using Garmin Adventurous Routing™.....	41	Viewing Current Location Information.....	49
Taking a Detour.....	41	Finding Emergency Services and Fuel.....	49
Going Home.....	41	Getting Directions to Your Current Location.....	49
Editing Your Home Location.....	41	Adding a Shortcut.....	49
Parking Near Your Destination.....	42	Removing a Shortcut.....	49
Traffic.....	42	Saving Locations.....	50
Receiving Traffic Data Using Your Smartphone.....	42	Saving a Location.....	50
Viewing Traffic on the Map.....	42	Saving Your Current Location.....	50
Finding and Saving Locations.....	43	Editing a Saved Location.....	50
Finding a Location Using the Search Bar.....	43	Assigning Categories to a Saved Location.....	50
Points of Interest.....	43	Deleting a Saved Location.....	50
Finding a Location by Category.....	44	Rider Awareness Features and Alerts.....	51
Navigating to Points of Interest Within a Venue.....	44	Enabling or Disabling Rider Alerts.....	51
Viewing Your Garmin Explore Points of Interest.....	44	Red Light and Speed Cameras.....	51
Synchronizing Garmin Explore Account Data.....	44	Fuel Tracking.....	51
Location Search Results.....	45	Enabling Fuel Tracking.....	52
Location Search Results on the Map.....	46	Setting a Low Fuel Warning.....	52
Changing the Search Area.....	46	Resetting the Fuel Tank Mileage.....	52
Finding Parking Near Your Current Location.....	46	Viewing Helmet Law Notifications.....	52
Finding Parking Near a Specified Location.....	46	Searching for Helmet Laws.....	52
Search Tools.....	47	Settings.....	53
Finding an Address.....	47	Map and Vehicle Settings.....	53
Finding an Intersection.....	47	Enabling Maps.....	53
Finding a Location Using Coordinates.....	47	Navigation Settings.....	53
Finding Fuel Stations and Prices.....	47	Calculation Mode Settings.....	53
Finding HISTORY Points of Interest.....	47	Setting a Simulated Location.....	54
Finding National Parks.....	48	Bluetooth Settings.....	54
		Wi-Fi Settings.....	54

Driver Assistance Settings	54	Garmin PowerSwitch	62
Display Settings	54	Mounting Considerations	62
Traffic Settings	55	Mounting the Device	62
Units and Time Settings	55	Opening the Front Cover	63
Setting the Time	55	Connecting Accessories	64
Language and Keyboard Settings	55	Connecting a Control Input	65
Device and Privacy Settings	55	Connecting the Device to Vehicle	
Restoring Settings	56	Power	65
Device Information	56	Pairing with a Garmin Navigation	
Viewing E-label Regulatory and		Device	66
Compliance Information	56	Garmin PowerSwitch	
Tread Specifications	56	Specifications	66
Group Ride Specifications	56	My Garmin PowerSwitch will not stay	
Charging the Device	57	connected	66
Device Maintenance	57	Wireless Cameras	66
Garmin Support Center	57	Pairing the Camera with a Garmin	
Map and Software Updates	57	Navigation Device	67
Connecting to a Wi-Fi Network	57	Viewing the Wireless Camera	67
Updating Maps and Software Using a		Installing a Memory Card for Maps and	
Wi-Fi Network	58	Data	69
Product Updates	58	Data Management	69
Device Care	60	About Memory Cards	69
Cleaning the Outer Casing	60	Connecting the Device to Your	
Cleaning the Touchscreen	60	Computer	69
Avoiding Theft	60	Transferring GPX Files From Your	
Restarting the Device	60	Computer	70
Removing the Device from the		Transferring Data From Your	
Mount	60	Computer	70
Troubleshooting	60	Disconnecting the USB Cable	70
My device is not acquiring satellite		Adding BaseCamp™ Data to Garmin	
signals	60	Explore	70
My battery does not stay charged for		Viewing GPS Signal Status	71
very long	61	Purchasing Additional Maps	71
My device does not connect to my		Index	72
phone	61		
My device does not appear as a			
removable drive on my computer	61		
My device does not appear as a portable			
device on my computer	61		
My device does not appear as either a			
portable device or a removable drive or			
volume on my computer	61		
Appendix	62		

Getting Started

⚠ WARNING

See the *Important Safety and Product Information* guide in the product box for product warnings and other important information.

- 1 Connect to a Wi-Fi® network (*Connecting to a Wi-Fi Network, page 57*)(optional).
- 2 Pair your Bluetooth® phone and headset (*Pairing Your Phone and Headset, page 32*) (optional).
- 3 Update the maps and software on your device (*Product Updates, page 58*).
- 4 Acquire GPS signals (*Acquiring GPS Signals, page 2*).
- 5 Mount the device and connect it to power (*Installation, page 4*).
- 6 Adjust the screen brightness (*Adjusting the Screen Brightness, page 3*).
- 7 Navigate to your destination (*Starting a Route, page 36*).

Device Overview



①	Power button
②	microSD® memory card slot
③	USB power and data port

Turning the Device On or Off

- To turn the device on, press the power button, or connect the device to power.
- To put the device in power saving mode, press the power button while the device is on.
While in power saving mode, the screen is off and the device uses very little power, but it can wake instantly for use.
TIP: You can charge your device faster by putting it in power saving mode while charging the battery.
- To turn off the device completely, hold the power button until a prompt appears on the screen, and select **Off**.
The prompt appears after five seconds. If you release the power button before the prompt appears, the device enters power saving mode.

Acquiring GPS Signals









When you turn on your navigation device, the GPS receiver must collect satellite data and establish the current location. The time required to acquire satellite signals varies based on several factors, including how far you are from the location where you last used your navigation device, whether you have a clear view of the sky, and how long it has been since you last used your navigation device. The first time you turn on your navigation device, it may take several minutes to acquire satellite signals.

- 1 Turn on the device.
- 2 Wait while the device locates satellites.
- 3 If necessary, go to an open area, away from tall buildings and trees.

 in the status bar indicates the satellite signal strength. When at least half the bars are filled, the device is ready for navigation.







Status Bar Icons

The status bar is located at the top of the main menu. The status bar icons display information about features on the device. You can select some icons to change settings or view additional information.



	GPS signal status. Hold to view GPS accuracy and acquired satellite information (Viewing GPS Signal Status, page 71).
	Bluetooth technology status. Select to view the Bluetooth settings (Bluetooth Settings, page 54).
	Wi-fi signal strength. Select to change the wi-fi settings (Wi-Fi Settings, page 54).
	Connected to hands-free calling. Select to place a phone call (Hands-Free Calling, page 34).
	Active vehicle profile. Select to view the vehicle profile settings.
9:10	Current time. Select to set the time (Setting the Time, page 55).
	Battery charge level.
	Tread app connection status (Pairing Your Phone and Headset, page 32).
53°F	Temperature. Select to view the weather forecast (Viewing the Weather Forecast, page 25).
	Fuel status. Select to view fuel tracking information (Fuel Tracking, page 51).

Using the On-Screen Buttons

On-screen buttons allow you to navigate the pages, menus, and menu options on your device.

- Select  to return to the previous menu screen.
- Hold  to quickly return to the main menu.
- Select  or  to scroll through lists or menus.
- Hold  or  to scroll faster.
- Select  to see a context-based menu of options for the current screen.

Adjusting the Volume

- 1 Select .
- 2 Select an option:
 - Use the slider bar to adjust the volume.
 - Select  to mute the device.
 - Select a check box to enable or disable additional sound options.

Using the Audio Mixer

You can use the audio mixer to set the volume levels for different audio types, such as navigation prompts or phone calls. The level for each audio type is a percentage of the master volume.

- 1 Select .
- 2 Select **Mixer**.
- 3 Use the sliders to adjust the volume for each audio type.

Adjusting the Screen Brightness

- 1 Select  > **Display** > **Brightness**.
- 2 Use the slider bar to adjust the brightness.





Vehicle Profiles

WARNING

Vehicle profile selections are not used to calculate route suggestions.

Your vehicle profile is only used to display which trails your vehicle can use, based on the US Forest Service Motor Vehicle Use Maps. Limitation may exist in that map data such that your device cannot account for trail conditions in all cases. Always defer to all posted trail signs and conditions when making driving decisions.

Vehicle profiles allow you to choose different settings based on each vehicle you use with the device. The current vehicle profile is indicated by an icon in the status bar.

	Motorcycle mode
	ATV mode
	Side-by-side mode
	Full size mode
	Snowmobile mode

Adding a Vehicle Profile

You can add a vehicle profile for each vehicle to be used with your device.

- 1 Select the vehicle profile icon from the status bar, and select **+**.
- 2 Select an option:
 - To add a motorcycle, select **Motorcycle**.
 - To add an ATV, select **ATV**.
 - To add a side-by-side, select **Side-by-Side**.
 - To add a full size vehicle, select **Full Size**.
 - To add a snowmobile, select **Snowmobile**.
- 3 Follow the on-screen instructions to enter the vehicle characteristics.

Choosing a Vehicle Profile

Select the vehicle profile icon on the status bar.

Installation

Mounting Your Device in an ATV or Side-by-Side

Power Cable Overview

⚠ WARNING

See the *Important Safety and Product Information* guide in the product box for product warnings and other important information.

Garmin® strongly recommends having an experienced installer with the proper knowledge of electrical systems install the device. Incorrectly wiring the power cable can result in damage to the vehicle or the battery and can cause bodily injury.

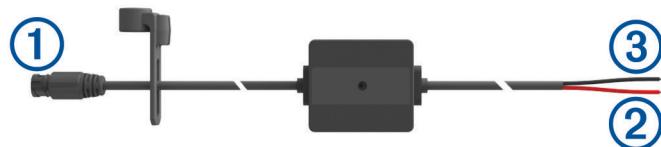

①	Mount connector
②	10 to 30 Vdc system power (red)
③	System ground (black)

Mounting Considerations

- The device must be mounted close to the bus bar or battery and within the range of the supplied power cable.
- The mounting location must allow for the routing and connection of all cables.
- Excess wire should be bundled and secured using the included zip ties.
- The electrical contacts must be free from paint.

Mounting the Device on a Roll Bar

- 1 Using a flat head screwdriver or $\frac{9}{32}$ in. (7 mm) nut driver, loosen the bolt ① on the roll bar mount until the ring separates.

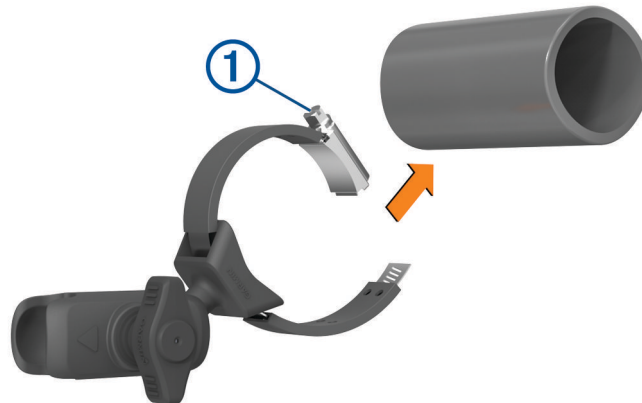

- 2 Place the mount around the roll bar.
- 3 Tighten the bolt on the mount until the ring is secure.
- 4 Insert the ball on the Group Ride mount ② into the double-socket arm ③.

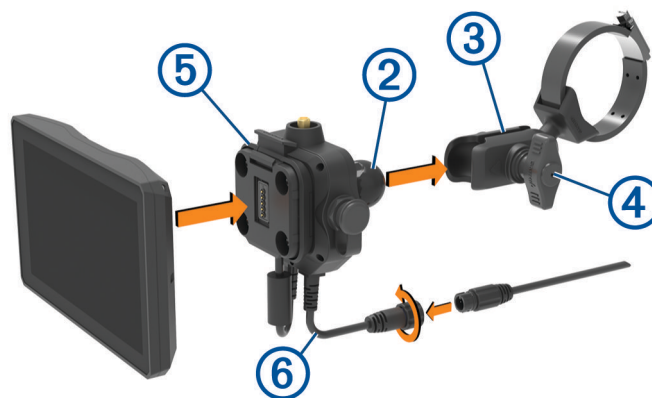

- 5 Tighten the knob ④ slightly.
- 6 If necessary, rotate the Group Ride mount ⑤ so the Garmin logo faces up, and adjust the mount for better viewing and operation.
- 7 Tighten the knob ④ to secure the mount.
- 8 Press the device into the Group Ride mount until it snaps into place.
- 9 Connect the Group Ride power cable ⑥ to the connector on the vehicle wiring harness.
- 10 Tighten the collar around the connected power cables.
- 11 Route the power cable along a suitable path in your vehicle, and secure it using the included zip ties.

Mounting the Antenna

NOTE: The mounted antenna must be at least 4 cm (1.57 in.) away from the nearest roll bar or metal surface to avoid radio interference.

You can use the external antenna mount to mount your antenna in a more suitable location for your vehicle, such as a roll bar at the rear of your vehicle, to receive better radio reception. For the best results, use this method for vehicles that have a roll cage.

- 1 Screw down and tighten the antenna cable ① onto the Group Ride mount ②.

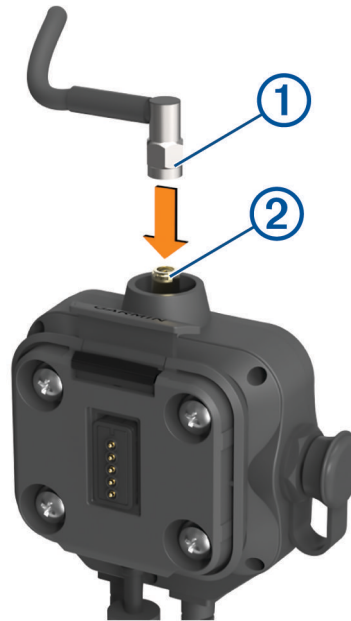

- 2 Find a suitable location for the antenna.
- 3 Using a flat head screwdriver or $\frac{5}{16}$ in. (8 mm) nut driver, loosen the bolt ③ on the external antenna mount until the ring separates.



- 4 Place the mount around the roll bar.
- 5 Tighten the bolt on the mount until the ring is secure.

- 6 Screw down and tighten the antenna ④ onto the external antenna mount plate.
- 7 Route the antenna cable along a suitable path in your vehicle, and secure it using the included zip ties.

Installing the Antenna on the Group Ride Mount

NOTE: The mounted antenna must be at least 4 cm (1.57 in.) away from the nearest roll bar or metal surface to avoid radio interference.

For the best range performance, use the external antenna mount. You can mount the antenna directly onto the Group Ride mount when it is not possible to use the external antenna mount ([Mounting the Antenna, page 6](#)).

Screw down and tighten the antenna onto the Group Ride mount.



Installing the Fist Microphone and Mount

Before you can attach the fist microphone mount to your dashboard, you must select a suitable location on the dashboard.

⚠ WARNING

It is your responsibility to ensure the mounting location complies with all applicable laws and ordinances, and does not block your view of the road during the safe operation of your vehicle.

NOTICE

Avoid wires, gauges, air bags, air bag covers, HVAC, and other items when drilling pilot holes and attaching the mount to the vehicle. Garmin is not responsible for any damages or consequences arising from the installation.

NOTE: This feature is not available on all product models.

- 1 Align and insert the connector on the fist microphone onto the Group Ride mount.



- 2 Tighten the collar around the connected cable.
- 3 Place the mount ① on the selected location.

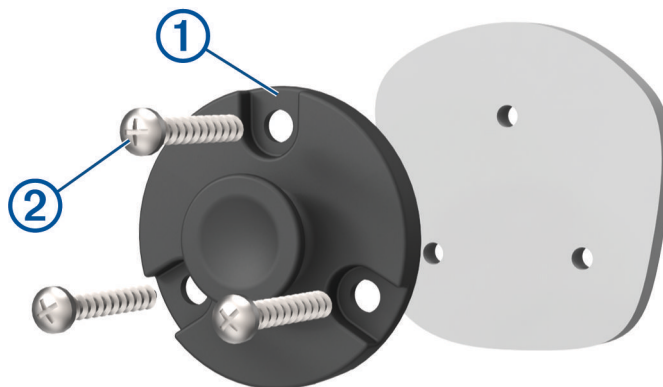

- 4 Using the mount as a template, mark the three screw locations.
- 5 Drill pilot holes (optional).
For some types of mounting material, drilling pilot holes is necessary.
- 6 Securely fasten the mount to the surface using the supplied screws ②.
- 7 Slide the fist microphone ③ onto the mount.



Removing Your Device from the Mount

- 1 Press the release button on the top of the mount.
- 2 Lift out the device.

Replacing the Trim Ring

You can replace the trim ring on your device with one of the included, colored trim rings.

- 1 Remove the device from the mount.
- 2 Pull back on the existing trim ring to remove it from the device.



- 3 Place the new trim ring on the device and snap it into place.

Off-Road Navigation Features

Routes

A route is a path from your current location to one or more destinations.

- For off-road use, you can set the device to calculate point-to-point routes in a straight line ([Straight Line Routes](#), page 10).
- The device calculates a recommended route to your destination based on the preferences you set, including the route calculation mode ([Changing the Route Calculation Mode](#), page 41) and avoidances ([Avoiding Delays, Tolls, and Areas](#), page 39).
- You can start navigating to your destination quickly using the recommended route, or you can select an alternate route ([Starting a Route](#), page 36).
- If there are specific roads you need to use or avoid, you can customize the route ([Shaping Your Route](#), page 39).
- You can add multiple destinations to a route ([Adding a Location to Your Route](#), page 38).

Straight Line Routes

For off-road use, the device guides you to your destination using a straight line route. You can set multiple waypoints to navigate a route through areas without roads.

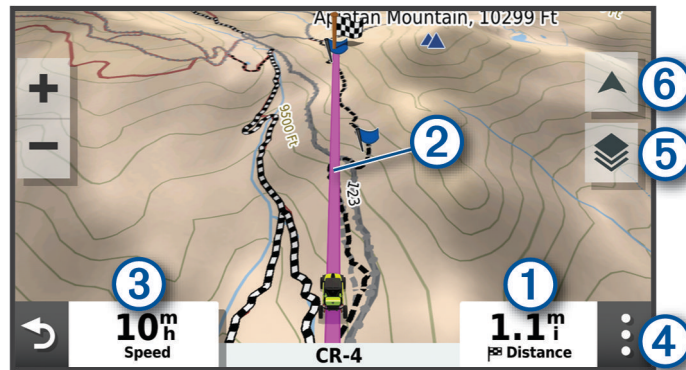

- ① Distance to the destination.
- ② Route highlighted on the map.
- ③ Vehicle speed.
- ④ Map tools. Provides tools to show you more information about your route and surroundings.
- ⑤ Map layers. Allows you to change the map orientation and add topographic and BirdsEye imagery to your map view.
- ⑥ Map perspective. Allows you to change the map perspective between track up, 2-D, and 3-D.

Skipping the Next Stop on Your Route

You can skip an upcoming location you previously added to your route.

From the map, select  > **Yes**.

Stopping the Route

From the map, select  > **Stop**.

Tracks

A track is a recording of your path. The track log contains information about the recorded path, including time, location, and elevation information.

Recording Tracks

Tracking records your path. When you start tracking, your device logs your location and updates the track line. If your device is paired with a Garmin Explore™ account, your device periodically synchronizes recorded tracks with the app.

- 1 From the main screen, select **Track**.
- 2 Select **Start**.

Navigating a Track

You can navigate a saved track using the Garmin Explore app on your device.

- 1 Select **Explore > Tracks**.
- 2 Select a track.
- 3 Select **Go!**.

Viewing Your Collections on the Map

You can view your Garmin Explore collections directly on the map. You must enable the collections map layer to use this feature.

NOTE: If you do not assign a collection category to your Garmin Explore data, it appears as an unorganized collection.

- 1 Select **View Map >  > Collections**.
- 2 Select one or more collection categories from the list.
- 3 Select **Save**.

Your collections appear as icons on the map.

Pitch and Roll

WARNING

The Pitch and Roll application is intended to show vehicle angles based on calibrated measurements only. You are responsible for calibrating the device. Changes to the position of the device after calibration may affect the accuracy of its measurements. Measured values are suggestions only based on your input into the device. Take readings often and carefully, and allow the readings to stabilize after significant changes in environmental conditions. Always allow a margin of safety for changing conditions and reading errors. Failure to account for your vehicle and your environment could cause an incident resulting in death or serious injury.

The device alerts you if your vehicle pitches or rolls at an angle that could affect the vehicle's stability.

Calibrating Pitch and Roll

You can set the angle of your vehicle to zero at any time.

- 1 Park your vehicle on a flat, level surface.
- 2 Adjust the position of your device in the mount so you can comfortably view the screen.
- 3 Select **Pitch and Roll > Calibrate**.

The values for pitch and roll reset to 0 degrees.

WARNING

To maintain the best accuracy, you must calibrate pitch and roll each time you reposition your device.

Adjusting Warning Angles

You can adjust the angles at which the device activates a pitch or roll alert. You are responsible for knowing and setting the correct pitch and roll angle for your vehicle.

- 1 Select **Pitch and Roll** >  > **Warning Angles**.
- 2 Swipe up or down to adjust the pitch or roll warning angles.
- 3 Select **OK**.

Enabling or Disabling Warning Angle Alerts

- 1 Select **Pitch and Roll** > .
- 2 Select an option:
 - To enable or disable pitch and roll notifications, select **Pitch and Roll Notifications**.
 - To enable or disable audible alerts, select **Audible Alerts**.

Viewing the Altimeter, Barometer, and Compass

The device contains internal altimeter, barometer, and compass sensors with automatic calibration.

From the main menu, select **ABC**.

Calibrating the Compass

NOTICE

Calibrate the electronic compass outdoors. To improve heading accuracy, do not stand near metal objects or objects that influence magnetic fields, such as vehicles, electronic devices, buildings, or overhead power lines.

When your device is connected to the mount, it uses GPS data to determine your compass heading. When you remove the device from the mount, it uses a built-in compass to show your heading.

Each time you disconnect your device from the mount, the device prompts you to calibrate the compass.

If you experience irregular compass behavior, for example, after moving long distances or after extreme temperature changes, you can manually calibrate the compass to improve accuracy.

- 1 Disconnect the device from the mount and move away from objects that influence magnetic fields.
- 2 Select **ABC** >  > **Calibrate Compass**.
- 3 Follow the on-screen instructions.

Group Ride

The Group Ride app allows you to coordinate rides and communicate with nearby riders using preset text messages, live map locations, and voice communications.

Starting a Group Ride

You can create a group ride that allows you to choose the group radio channel, view and remove riders who join your group ride, and set the group ride name.

- 1 From the main menu, select **Group Ride** > **Start a Group Ride**.
- 2 Enter your rider name, and select **Done**.
- 3 If necessary, select the radio channel, and select **Next**.
- 4 Enter the ride name, and select **Done**.
As riders join your group ride, their names appear on the list.
- 5 Select **Start**.

The group ride begins after all riders sync with the group ride.

Joining a Group Ride

You can join a nearby group ride that was created by another rider.

NOTE: For some product models, the Group Ride app is located in the apps menu.

- 1 From the main menu, select **Group Ride > Nearby Group Rides**.
- 2 Select a nearby group ride, and select **Join**.

Rejoining a Recent Group Ride

You can rejoin any of your ten most-recent group rides.

- 1 From the main menu, select **Group Ride > Recent Group Rides**.
- 2 Select a recent group ride, and select **Join**.

Adding Riders to a Group Ride

You can add riders to a group ride that is already in progress.

- 1 From the main menu, select **Group Ride**.
- 2 If necessary, select .
- 3 Select **Add**.
As new riders join the group ride, they appear on the list.
- 4 Select **Continue**.

Broadcasting a Message

WARNING

Do not read, send, or reply to any messages while driving. If you do so, you could become distracted by the display, which could lead to an accident causing personal injury or death.

You can broadcast a preset message to the members in your active group ride that are in range of the VHF radio.

- 1 From the main menu, select **Group Ride**.
- 2 If necessary, select .
- 3 Select **Broadcast to Group**.
- 4 Select a preset message, and select **Send**.

Broadcasting a Location

WARNING

While driving, do not interact with the display to broadcast your location. If you do so, you could become distracted by the display, which could lead to an accident causing serious personal injury or death.

You can broadcast a location to the members in your active group ride that are in range of the VHF radio.

- 1 From the main menu, select **Group Ride**.
- 2 If necessary, select .
- 3 Select **Broadcast to Group > Broadcast a Location**, and select a location.
- 4 Select **Share**.

Viewing a Group Ride Notification

WARNING

Do not read or reply to any notifications while driving. If you do so, you could become distracted by the display, which could lead to an accident causing serious personal injury or death.

From most pages, a notification appears when the device receives a broadcasted group ride location or message. You can also view group ride notifications in the Group Ride app.

NOTE: When you are viewing the map, new notifications appear in a map tool at the edge of the screen..

- 1 From the main menu, select **Group Ride** > , and select a notification.
- 2 Select **Go!** to navigate to a shared location.

Exiting a Group Ride

- 1 From the main menu, select **Group Ride**.
- 2 If necessary, select .
- 3 Select **Exit** > **Yes**.

Group Ride Settings

From the main menu, select **Group Ride** > .

Edit Rider Name: Allows you to set your name that displays during a group ride. This setting is not available during an active group ride.

Rider Map Labels: Sets the label to be displayed on each active rider on the map.

Show Tracks on Map: Shows the track that each group ride member takes on the map.

Auto Zoom to Group: Enables the map to automatically zoom to the active group ride.

Reset Default Settings: Allows you to reset all group ride settings to default values. This setting is not available during an active group ride.



Radio

NOTE: This feature is not available on all product models.



You can use the radio app to create radio presets, select a radio channel, and select squelch codes. To use this feature, you must connect the device and the antenna to the Group Ride mount. The Tread device configures radio settings automatically when you join or create a group ride.

Selecting a Preset

NOTE: For some product models, the Radio app is located in the apps menu.

- 1 From the main menu, select **Radio**.
- 2 Select an option:
 - To move through available presets, select  or .
 - To select a preset from the menu, select **Preset**.

Selecting a Radio Channel

- 1 From the main menu, select **Radio**.
- 2 Select an option:
 - To move to a different channel, select  or .
 - To select a MURS channel from the menu, select **Channel**.

Adjusting the Squelch

You can adjust the squelch and change between CTCSS, DCS, and Open squelch modes to improve audio quality and avoid radio interference in your area.

- 1 From the main menu, select **Radio**.
- 2 Select an option:
 - To choose a squelch code within the current mode, select **+** or **-**.
 - To adjust the squelch mode, select **Open**.

Adding a Custom Radio Preset

- 1 Select **Radio** > **Preset** > **+**.
- 2 Select **+** or **-** to select a channel and squelch code.
- 3 Select **Save**.

Selecting a Roger Tone

You can select the tone other devices play when you operate your radio.

- 1 Select **Radio** >  > **Roger Tone**.
- 2 Select a roger tone.



The device plays the selected tone.
- 3 Select **Save**.

Turning the Radio Off

Select **Radio** >  > **Yes**.

Enabling Push-to-Talk with a Headset

You can enable push-to-talk controls for use with a compatible Bluetooth headset. This allows you to transmit your voice using the voice dial feature on your headset.

- 1 Select **Radio** >  > **Push to Talk with Headset**.
- 2 If necessary, follow the on-screen instructions to pair your headset with the device.
- 3 Select **Push to Talk with Headset**.
- 4 Select .

Transmitting Your Voice

Before you can transmit your voice, you must pair your Tread device with a compatible Bluetooth headset or connect the fist microphone.

You can transmit your voice over the radio using the connected fist microphone or a compatible Bluetooth headset.

NOTE: For some product models, the Radio app is located in the apps menu.

Select an option:

- Hold the push-to-talk button on the side of the connected fist microphone (*Installing the Fist Microphone and Mount, page 8*).
- From the main menu, select **Radio** > **Push to Talk**.
- Use the voice dial feature on your connected Bluetooth headset (*Enabling Push-to-Talk with a Headset, page 15*).

TIP: You can press the pause or stop button to manually close the radio.

NOTE: You must enable the **Push to Talk with Headset** setting to use this feature (*Radio Settings, page 16*).

Adjusting the Radio Volume

- 1 Select **Radio** > ).
- 2 Use the slider bars to adjust the volume.

Radio Settings

From the main menu, select **Radio** > .

Push to Talk with Headset: Enables you to transmit your voice using the push-to-talk button on your compatible headset.

Roger Tone: Sets the roger tone the device plays when you operate your radio.

Reset Default Settings: Resets all radio settings and presets to factory default values.

inReach® Remote

The inReach remote function allows you to control your inReach satellite communication device (sold separately) using your Tread device. You can send messages, view weather reports, trigger an SOS alert, and more. Go to buy.garmin.com to purchase an inReach device.

Connecting an inReach Device



- 1 Bring the inReach device within 3 m (10 ft.) of your Tread device.
- 2 On your Tread device, select  > **inReach**.
- 3 Follow the on-screen instructions on your Tread device to complete the pairing process.

After the pairing process is complete, the inReach and Tread devices connect automatically when they are within range.

Sending an inReach Message

Before you can send an inReach message using your Tread device, you must pair it with a compatible inReach device ([Connecting an inReach Device, page 16](#)).

You can use your device to send inReach messages to your contacts.

- 1 Select  > **inReach** > .
- 2 Select **New Message**.
- 3 Select **Select Contacts** to add one or more contacts.
- 4 Enter a message.
- 5 Select **Send**.

SOS

During an emergency, you can contact the GEOS International Emergency Rescue Coordination Center (IERCC) to request help. Pressing the SOS button sends a message to the rescue coordination center, and they notify the appropriate emergency responders of your situation. You can communicate with the rescue coordination center during your emergency while you wait for help to arrive. You should only use the SOS function in a real emergency situation.

Initiating an SOS Rescue

Before you can initiate an SOS rescue using your Tread device, you must pair it with a compatible inReach device ([Connecting an inReach Device, page 16](#)).

NOTICE

While in SOS mode, the inReach device cannot be turned off.

1 Select  > **inReach**.

2 Select .

3 Wait for the SOS countdown.

The device sends a default message to the emergency response service with details about your location.

4 Reply to the confirmation message from the emergency response service.

Your reply lets the emergency response service know that you are capable of interacting with them during the rescue.

For the first 10 minutes of your rescue, an updated location is sent to the emergency response service every minute. To conserve battery power after the first 10 minutes, an updated location is sent every 10 minutes when moving, and every 30 minutes when stationary.

Canceling an SOS Rescue

If you no longer need assistance, you can cancel an SOS rescue after it is sent to the emergency response service.

Select **Cancel SOS > Cancel SOS**.

Your device transmits the cancellation request. When you receive a confirmation message from the emergency response service, the device returns to normal operation.





Using the Map

You can use the map to navigate a route ([Your Route on the Map, page 37](#)) or to view a map of your surroundings when no route is active.

1 Select **View Map**.

2 Touch anywhere on the map.

3 Select an option:

- Drag the map to pan left, right, up, or down.
- To add or remove map layers such as topographic and BirdsEye imagery, select .
- To zoom in or out, select  or .
- To switch between North Up, 2-D, and 3-D views, select .
- To start a route, select a location on the map, and select **Go!** ([Starting a Route by Using the Map, page 36](#)).

Map Tools

Map tools provide quick access to information and device functions while you view the map. When you activate a map tool, it appears in a panel at the edge of the map.

Stop: Stops navigation of the active route.

Edit Route: Allows you to take a detour or skip locations in your route (*Changing Your Active Route*, page 38).

Mute: Mutes the device audio.

Cities Ahead: Shows upcoming cities and services along your active route or along a highway (*Cities Ahead*, page 19).

Up Ahead: Shows upcoming locations along the route or the road on which you are traveling (*Up Ahead*, page 18).

Elevation: Displays elevation changes ahead.

Traffic: Displays traffic conditions along your route or in your area (*Viewing Upcoming Traffic*, page 20). This feature is not available in all areas or for all device models.

Trip Data: Displays customizable trip data, such as speed or mileage (*Viewing Trip Data from the Map*, page 19).

Track Recorder: Displays the track data for your active route.

Turns: Displays a list of upcoming turns in your route (*Viewing Turns and Directions*, page 38).

Phone: Displays a list of recent phone calls from your connected phone, and displays in-call options while a phone call is active (*Using In-Call Options*, page 34).

Weather: Displays weather conditions for your area.

Report Safety Camera: Allows you to report a speed or red light camera. This tool is available only when you have speed or red light camera data on your device and you have an active connection to the Tread app (*Pairing Your Phone and Headset*, page 32).



Music Player: Displays media controls and media information.

Pitch and Roll: Displays the current angle of your vehicle (*Pitch and Roll*, page 11).

Group Ride: Displays the distance and direction of the members in your group ride (*Group Ride*, page 12).

Radio: Allows you to use the push-to-talk feature with a compatible Bluetooth headset (*Enabling Push-to-Talk with a Headset*, page 15).

Viewing a Map Tool

- 1 From the map, select .
- 2 Select a map tool.
The map tool appears in a panel at the edge of the map.
- 3 When you are done using the map tool, select .

Up Ahead

The Up Ahead tool provides information about upcoming locations along your route or the road on which you are traveling. You can view upcoming points of interest by category, such as restaurants, fuel stations, or rest areas.



You can customize the categories that show in the Up Ahead tool.

Viewing Upcoming Locations

- 1 From the map, select  > **Up Ahead**.
While you are traveling, the map tool shows the next location along your road or route.
- 2 Select an option:
 - If the map tool shows categories, select a category to view a list of nearby locations in that category.
 - If the map tool shows upcoming locations, select a location to view location details or start a route to the location.

Customizing the Up Ahead Categories

You can change the location categories that appear in the Up Ahead tool.

- 1 From the map, select  > **Up Ahead**.
- 2 Select a category.
- 3 Select .
- 4 Select an option:
 - To move a category up or down in the list, select and drag the arrow next to the category name.
 - To change a category, select the category.
 - To create a custom category, select a category, select **Custom Search**, and enter the name of a business or category.
- 5 Select **Save**.

Cities Ahead

While you are traveling on a highway or navigating a route that includes a highway, the Cities Ahead tool provides information about upcoming cities along the highway. For each city, the map tool shows the distance to the highway exit and the services available, similar to the information on highway road signs.

Viewing Upcoming Cities and Exit Services

- 1 From the map, select  > **Cities Ahead**.

While you are traveling along a highway or an active route, the map tool shows information about upcoming cities and exits.
- 2 Select a city.

The device shows a list of points of interest located at the selected city exit, such as fuel stations, lodging, or restaurants.
- 3 Select a location, and select **Go!** to start navigating.

Trip Information

Viewing Trip Data from the Map

Before you can view trip data on the map, you must add the tool to the map tools menu.

From the map, select  > **Trip Data**.

Customizing the Trip Data Fields

- 1 From the map, select  > **Trip Data**.
- 2 Select a trip data field.
- 3 Select an option.

The new trip data field appears in the trip data map tool.

Viewing the Trip Information Page

The trip information page displays your speed and provides statistics about your trip.



From the map, select **Speed**.

Resetting Trip Information

- 1 From the map, select **Speed**.
- 2 Select  > **Reset Field(s)**.
- 3 Select an option:
 - When not navigating a route, select **Select All** to reset every data field except the speedometer, on the first page.
 - Select **Reset Overall Data** to reset the information on the trip computer.
 - Select **Reset Max. Speed** to reset the maximum speed.
 - Select **Reset Trip B** to reset the odometer.

Viewing Upcoming Elevation Changes

You can view upcoming elevation changes along your route. This can help you avoid or plan for steep uphill or downhill grades.

- 1 From the map, select  > **Elevation**.
- 2 Select the chart to expand it to the full screen.
The device displays your current elevation, and a chart of elevation over distance.
- 3 Select an option:
 - Select  or  to change the distance range of the chart.
 - Select the arrows to scroll the chart.

Viewing Upcoming Traffic

NOTICE

Garmin is not responsible for the accuracy or timeliness of the traffic information.



Before you can use this feature, your device must be receiving traffic data ([Traffic, page 42](#)).

You can view traffic incidents coming up along your route or along the road on which you are traveling.



- 1 While navigating a route, select  > **Traffic**.
The nearest upcoming traffic incident appears in a panel on the right side of the map.
- 2 Select the traffic incident to view additional details.

Viewing Traffic on the Map

The traffic map shows color-coded traffic flow and delays on nearby roads.

- 1 From the main menu, select  > **Traffic**.
- 2 If necessary, select  > **Legend** to view the legend for the traffic map.

Searching for Traffic Incidents

- 1 From the main menu, select  > **Traffic**.
- 2 Select  > **Incidents**.
- 3 Select an item in the list.
- 4 If there is more than one incident, use the arrows to view additional incidents.

Customizing the Map

Customizing the Map Layers

You can customize which data appear on the map, such as topographic maps and BirdsEye imagery.

- 1 Select  > **Map Display** > **Map Layers**.
- 2 Select the check box next to each layer you want to show on the map.

Viewing the Public Lands Map Key

Public lands are color-coded on the map to show who owns a specific plot of land. For example, you can see if a plot of land is privately owned or if it is part of a national park. You must enable the public lands map layer to use this feature (*Customizing the Map Layers, page 20*).

You can view the legend for these colors on the device.

Select  > **Map Display** > **Map Layers** >  > **Public Lands**.

Enabling Adventure Roads and Trails Map Layers

You can enable or disable map layers that display accessible or inaccessible roads for different types of motor vehicles.

- 1 Select  > **Map Display** > **Map Layers** >  > **Adventure Roads & Trails**.
- 2 Select a road or trail type.

Changing the Map Data Field

- 1 From the map, select a data field.
NOTE: You cannot customize Speed.
- 2 Select a type of data to display.

Changing the Map Buttons

- 1 From the map, hold a map button.
- 2 Select an option:
 - To replace a map button, select a map button, and select a map button to display.
 - To remove a map button, select .
- 3 Select **Save**.



Changing the Map Perspective

- 1 Select  > **Map Display** > **Driving Map View**.
- 2 Select an option:
 - Select **Track Up** to display the map in two dimensions (2-D), with your direction of travel at the top.
 - Select **North Up** to display the map in 2-D with north at the top.
 - Select **3-D** to display the map in three dimensions.

Using the Apps

Viewing the Owner's Manual on Your Device

You can view the complete owner's manual on the device screen in many languages.

- 1 Select  > **Owner's Manual**.
The owner's manual appears in the same language as the software text.
- 2 Select  to search the owner's manual (optional).

Music Player

The music player can play music or audio from these sources.

- Music files stored on your Tread device.
- Bluetooth audio from a paired phone.

Adding the Music Player Tool to the Map



The music player map tool enables you to control the music player from your map.

- 1 Open the map.
- 2 Select  > **Music Player**.

The music player controls appear on the map.

Changing the Media Source

You can change the source from which media is played on your device.

- 1 Select  > **Music Player**.
- 2 Select the current media source .

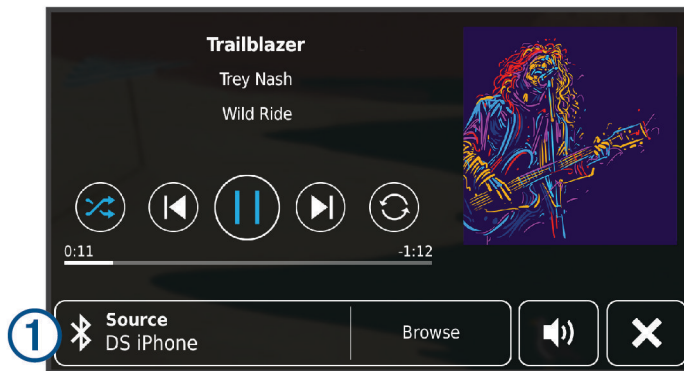



- 3 Select an available media source from the list.

BirdsEye Imagery

BirdsEye imagery provides downloadable, high-resolution map imagery, including detailed satellite imagery and raster-based topographical maps. You can download BirdsEye Satellite Imagery directly to your device when it is connected to a Wi-Fi network.

Downloading BirdsEye Imagery

Before you can download BirdsEye imagery directly to your device, you must connect to a wireless network ([Connecting to a Wi-Fi Network, page 57](#)).

- 1 Select  > **BirdsEye Direct**.
- 2 Select .
- 3 Select an option:
 - To download BirdsEye imagery files for a specific location or area, select **Location**, and select a category.
NOTE: The location defaults to your current location.
 - To select an image quality option, select **Detail**.
 - To define the size of the area to be shown in the downloaded imagery files, select **Size**, and enter a distance from the selected location.
 - To select where to save the downloaded imagery, select **Save To**.
- 4 Select **Download**.
- 5 Enter a name for the downloaded imagery and select **Done**.

Trip Planner





You can use the trip planner to create and save a trip, which you can navigate later. This can be useful for planning a delivery route, a vacation, or a road trip. You can edit a saved trip to further customize it, including reordering locations, optimizing the order of stops, adding suggested attractions, and adding shaping points. You can also use the trip planner to edit and save your active route.

Planning a Trip

A trip can include many destinations, and it must include at least a starting location and one destination. The starting location is the location from which you plan to start your trip. If you start navigating the trip from a different location, the device gives you the option to route to your starting location first. For a round trip, the starting location and final destination can be the same.

- 1 Select  > **Trip Planner** > **New Trip**.
- 2 Select **Select Start Location**.
- 3 Choose a location for your starting point, and select **Select**.
- 4 Select **Select Destination**.
- 5 Choose a location for a destination, and select **Select**.
- 6 Select **Add Location** to add more locations (optional).
- 7 After you have added all the necessary locations, select **Next** > **Save**.
- 8 Enter a name, and select **Done**.

Editing and Reordering Locations in a Trip

- 1 Select  > **Trip Planner** > **Saved Trips**.
- 2 Select a saved trip.
- 3 Select a location.
- 4 Select an option:
 - To move the location up or down, select , and drag the location to a new position in the trip.
 - To add a new location after the selected location, select .
 - To remove the location, select .

Optimizing the Order of Destinations in a Trip

The device can automatically optimize the order of destinations in your trip to create a shorter, more efficient route. The starting location and final destination are not changed when you optimize the order.

While editing a trip, select  > **Optimize Order**.



Discovering Attractions Along Your Trip

The device can suggest interesting or popular attractions to add to your trip.

- 1 While editing a trip, select  > **Suggest Attractions**.
- 2 Select an attraction to view more information.
- 3 Select **Select** to add the attraction to your trip.

Changing Routing Options for a Trip

You can customize how the device calculates the route when you start your trip.

- 1 Select  > **Trip Planner** > **Saved Trips**.
- 2 Select a saved trip.
- 3 Select the vehicle profile icon, and select the vehicle you plan to use while navigating the trip (optional).
- 4 Select .
- 5 Select **Route Preference** to change the calculation mode for the trip ([Changing the Route Calculation Mode](#), page 41).

Changing Transportation Modes in a Trip

You can change the transportation modes used to travel in a saved trip.

- 1 Select  > **Trip Planner**.
- 2 Select a trip.
- 3 Select the vehicle icon.
- 4 Select a transportation mode.
- 5 Select **Select**.

Navigating to a Saved Trip

- 1 Select  > **Trip Planner** > **Saved Trips**.
- 2 Select a saved trip.
- 3 Select **Go!**.
- 4 Select the first location to navigate to, and select **Start**.

The device calculates a route from your current location to the selected location, and then it guides you to the remaining trip destinations in order.

Sharing a Route

You can share routes with other Tread devices.

- 1 Select  > **Share Route**.
- 2 Select an option:
 - To share a route using Tread, select **Garmin Tread™**.
 - To share a route using a Bluetooth connection, select **Bluetooth**.
 - To copy the route to a microSD card, select **Memory Card**.
- 3 Select a route.
- 4 Select **Done**.
- 5 Follow the on-screen instructions on your Tread device to complete the sharing process.

TracBack

Following Your Recent Track

The TracBack feature records the most recent segment of your movement. You can retrace your recent track back to a previous location.

- 1 Select  > **TracBack**.
Your recent track appears on the map.
- 2 Select **Go!**.

Saving Your Recent Track as a Trip

You can save your recent track as a trip, which you can navigate later using the trip planner ([Navigating to a Saved Trip, page 24](#)).

- 1 Select **TracBack**.
Your recent track appears on the map.
- 2 Select  > **Save as Trip**.
- 3 Enter a name, and select **Done**.

Viewing the Weather Forecast

NOTICE

Garmin is not responsible for the accuracy or timeliness of the weather data.

Before you can use this feature, your device must be receiving weather data. You can connect your device to the Tread app to receive weather data ([Pairing Your Phone and Headset, page 32](#)).

- 1 Select  > **Weather**.

The device shows the current weather conditions and a forecast for the next several days.

- 2 Select a day.

The detailed forecast for that day appears.

Viewing Weather Near a Different City

- 1 Select  > **Weather** > **Current Location**.

- 2 Select an option:

- To view weather for a favorite city, select a city in the list.
- To add a favorite city, select **Add City**, and enter a city name.

Viewing the Weather Radar

Before you can use this feature, your device must be connected to a supported phone running the Tread app ([Pairing Your Phone and Headset, page 32](#)).

- 1 Select  > **Weather Radar**.

- 2 Select  to animate the radar map.

Viewing Weather Alerts

Before you can use this feature, your device must be connected to a supported phone running the Tread app ([Pairing Your Phone and Headset, page 32](#)).

NOTE: This feature is not available in all areas.

While you are traveling with your device, weather alerts may appear on the map. You can also view a map of weather alerts near your current location or near a selected city.

- 1 Select  > **Weather**.

- 2 If necessary, select a city.

- 3 Select  > **Weather Alerts**.

Checking Road Conditions

Before you can use this feature, your device must be connected to a supported phone running the Tread app ([Pairing Your Phone and Headset, page 32](#)).

You can view weather-related road conditions for the roads in your area, on your route, or in another city.



- 1 Select  > **Weather**.

- 2 If necessary, select a city.

- 3 Select  > **Road Conditions**.

Creating a Round-Trip Route

The device can create a round-trip route using a specified starting location and a distance, duration, or destination.

- 1 From the main menu, select  > **Round Trip**.
- 2 Select **Start Location**.
- 3 Select a location, and select **Select**.
- 4 Select **Trip Attributes**.
- 5 Select an option:
 - Select **Choose a Distance** to plan your route by distance.
 - Select **Choose a Duration** to plan your route based on time.
 - Select **Choose a Destination** to plan your route based on a specified location.
- 6 Select **Next**.
- 7 Enter a distance, duration, or destination.
- 8 Select an option:
 - If you entered a distance or duration, select **Done**.
 - If you selected a destination, select **Select**.
- 9 Select **Add a Direction**.
- 10 Select a direction, and select **Next**.
- 11 Select **Calculate**.
- 12 Select one or more options:
 - Select  to view elevation statistics along your route.
 - Select  to shape your route.
 - Use the slider to increase or decrease the level of adventure on your route.
- 13 Select a route, and select **Go!**.

Viewing Previous Routes and Destinations



Before you can use this feature, you must enable the travel history feature ([Device and Privacy Settings](#), page 55).

You can view your previous routes and places you have stopped on the map.

Select  > **Where I've Been**.

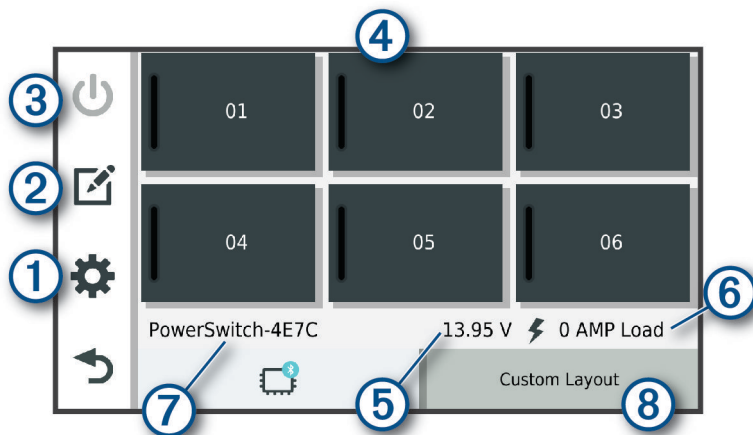
Garmin PowerSwitch™ App



① 	Opens the app settings menu
② 	Enters editing mode to customize the app layout and functions
③ 	Turns off all outputs
④ Power buttons	Activates each connected output
⑤	Displays input voltage
⑥	Displays the total amperage of the selected Garmin PowerSwitch device
⑦	Displays the device name
⑧	Displays Garmin PowerSwitch device tabs and custom layout tabs

Activating a Power Switch



Before you can use the Garmin PowerSwitch app to activate a switch, you must install your Garmin PowerSwitch device in your vehicle and pair it with the Garmin PowerSwitch app.

From the Garmin PowerSwitch app, select a power button to turn a switch on or off.

Turning Off All Switches

Select .

Customizing a Button

- 1 From the Garmin PowerSwitch app screen, select .
The app enters editing mode.
- 2 Select  on the button you want to customize.
- 3 Select an option:
 - To change the name of the button, select the **Button Label** field, and enter a name.
 - To add an icon to the button, select the **Icon** field, and select an icon.
 - To change the button color, select a color.
 - To change the button mode, select a button mode.
 - To adjust the intensity of the switch, use the slider.
 - To set the button to activate with a control input, select a control input.
- 4 Select .
- 5 Select **Done**.

Assigning a Switch to a Control Input



Before you can use control input functions, you must connect a control input to your Garmin PowerSwitch device ([Connecting a Control Input, page 65](#)).

You can assign one or more switches to turn on when the Garmin PowerSwitch device receives a signal from a control input.



- 1 Select .
- 2 Select your Garmin PowerSwitch device.
- 3 Select a control input.
- 4 Select one or more switches.

Adding a Custom Layout



You can add a custom layout tab to the Garmin PowerSwitch app. Buttons added to a custom layout can control multiple switches at the same time.

- 1 From the Garmin PowerSwitch app, select .
The device enters editing mode.
- 2 Select .



Adding a Button to a Custom Layout

- 1 From the Garmin PowerSwitch app, select a custom layout tab.
- 2 Select .
The app enters editing mode.
- 3 Select **Add Button**.
- 4 On the new button, select .
- 5 Select an option:
 - To change the name of the button, select the **Button Label** field, and enter a name.
 - To add an icon to the button, select the **Icon** field, and select an icon.
 - To change the button color, select a color.
- 6 Select **Add Action**.
- 7 If necessary, select a Garmin PowerSwitch device and a switch.
- 8 Select an action:
 - To set the button to turn the switch on or off with each press, select **Toggle**.
 - To set the button to turn on the switch, select **Turn On**.
 - To set the button to turn off the switch, select **Turn Off**.
- 9 Select a button mode:
 - To set the button to activate with one touch, select **Normal**.
 - To set the button to activate only while touching the button, select **Momentary**.
 - To set the button to turn on and off repeatedly, select **Strobe**, and select time intervals.
- 10 If applicable, use the slider to set the brightness of lights.
- 11 Select .
- 12 If necessary, select **Add Action** to add additional actions for the button.
You can add one action for every switch on the Garmin PowerSwitch device.

Arranging Buttons In a Custom Layout

- 1 From the Garmin PowerSwitch app, select a custom layout tab.
- 2 Select .
The app enters editing mode.
- 3 On the button you want to move, hold , and drag the button to a new location.

Deleting a Custom Layout or Button

- 1 From the Garmin PowerSwitch app, select a custom layout tab.
- 2 Select .
The app enters editing mode.
- 3 Select an option:
 - To delete a button, select  on the button you want to delete.
 - To delete a layout tab, select  on the layout tab.



Routines

Routines automate your Garmin PowerSwitch device. When you define a routine on your compatible Garmin navigation device, it turns switches on or off automatically when the conditions of the routine are met. For example, you can set a routine to turn on a switch at specific time each day or when your vehicle reaches a specific speed. Routines are available only when using a compatible Garmin navigation device.



Adding a Routine

- 1 From the Garmin PowerSwitch app, select  > **Routines**.
- 2 If necessary, select **Add Routine**.
- 3 Select **When**.
- 4 Select a trigger:
 - To set a switch to trigger when your vehicle reaches a specific speed, select **Speed** > **Next**, and follow the on-screen instructions to enter speed thresholds.
 - To set a switch to trigger at a specific time each day, select **Time** > **Next**, and enter a time.
 - To set a switch to trigger at sunrise, select **Sunrise**.
 - To set a switch to trigger at sunset, select **Sunset**.
- 5 Select **Add Action**.
- 6 Select a device, a switch, an action, and a button mode.
- 7 If necessary, use the slider to adjust the dimmer.
- 8 Select **Save**.

Editing a Routine

- 1 From the Garmin PowerSwitch app, select  > **Routines**.
- 2 Select  on the routine you want to edit.
- 3 Select an option:
 - To change the trigger for the routine, select **When**, and select a trigger.
 - To change an action, select  on the action you want to change, and update the action.
 - To add an action to the routine, select **Add Action**, and enter information about the action.
- 4 Select **Save**.

Deleting a Routine

- 1 From the Garmin PowerSwitch app, select  > **Routines**.
- 2 Select  on the routine you want to delete.

Dog Tracking

The dog tracking features allow you to see information transmitted from your handheld dog device on your Tread device. You can navigate to your dogs, view their current status and location, and observe the distance they have traveled.

Receiving Data From Your Handheld Device

Before you can receive data, you must enable broadcasting on your handheld dog device. See the owner's manual for your handheld dog device for more information.

Place your handheld dog device within 3 m (10 ft) of your Tread device.

TIP: Your Tread device receives data from one compatible handheld dog device at a time. Stay more than 3 m (10 ft) away from other handheld dog devices or disable broadcasting on handheld dog devices from which you do not want to receive data.

The devices  connect and synchronize automatically.

Tracking Your Dogs









- 1 Select  > **Dog Tracking**.

The dogs connected to your handheld dog device appear on the screen.
- 2 Select a dog.

The dog's location and track log appear on the map.
- 3 Select **Go!** to navigate to your dog.

Dog Status Icons

Icons indicate the status and location of your dogs.

	Sitting
	Running
	On point
	Treed
	Unknown*
	Collar battery low
	Collar connection lost
	Collar GPS reception lost

*The unknown status icon indicates the collar has not acquired a satellite signal and the handheld device cannot determine the location of the dog.

Viewing Your Dogs on the Map

- 1 While viewing the map, select anywhere on the map.
- 2 Select .

The device zooms to show all of your dogs on the screen.

Live Services, Traffic, and Smartphone Features

WARNING

Do not read or reply to any messages or notifications while driving. If you do so, you could become distracted by the display, which could lead to an accident causing personal injury or death.

NOTICE

Garmin is not responsible for the accuracy or timeliness of the traffic information.

The Tread app allows your device to receive smart notifications and live information, such as live traffic data and weather information.

Live traffic data: Sends live traffic data to your device, such as traffic incidents and delays, construction zones, and road closings ([Traffic, page 42](#)).

Weather information: Sends real-time weather forecasts, road conditions, and weather radar to your device ([Viewing the Weather Forecast, page 25](#)).

Smart Notifications: Displays phone notifications and messages on your device. This feature is not available for all languages.

Hands-Free calling: Allows you to place and receive phone calls through the device using your connected Bluetooth headset.





Send locations to device: Allows you to send locations from your smartphone to your navigation device.

Bluetooth Feature Status Icons

Status icons appear in the Bluetooth settings next to each paired device.

Select  > **Wireless Networks**.

- A gray icon indicates the feature is disabled or disconnected for that device.
- A colored icon indicates the feature is connected and active for that device.

	Hands-free calling
	Smart notifications
	Tread features and services
	Media streaming
	Headset is connected

Pairing Your Phone and Headset

The first time you turn on your device, you are prompted to pair your phone and headset. If necessary, you can complete setup at a later time by selecting  > **Complete Setup**. You must pair your Tread device with your phone and Bluetooth headset to use several Bluetooth features. After the devices are paired, they connect automatically when they are turned on and within range.

Some features also require the Tread app. You can connect to the Tread app during the pairing process or later.

- 1 Place the Tread device and your headset or phone within 3 m (10 ft.) of each other.
- 2 On your headset or phone, enable Bluetooth wireless technology, and set it to be discoverable.
See your headset or phone's owner's manual for more information.
- 3 On the Tread device, select  > **Wireless Networks**.
- 4 If necessary, select the check box to enable Bluetooth.
- 5 Select **Search for Devices** and choose your headset or phone from the list of nearby devices.
- 6 Follow the on-screen instructions to pair your headset or phone with your device.

Smart Notifications

While your device is connected to the Tread app, you can view notifications from your smartphone on your Tread device, such as text messages, incoming calls, and calendar appointments.

NOTE: You may need to wait a few minutes to receive notifications on your navigation device after it connects to the Tread app.  appears colored in the Bluetooth settings when smart notifications are connected and active ([Bluetooth Feature Status Icons, page 32](#)).

Receiving Notifications

WARNING

Do not read or reply to notifications while driving. If you do so, you could become distracted by the display, which could lead to an accident causing serious personal injury or death.

Before you can use this feature, your device must be connected to a supported phone running the Tread app ([Pairing Your Phone and Headset, page 32](#)).

From most pages, a popup appears when the device receives a notification from your smartphone. If the device is moving, you must verify you are a passenger and not the driver before you can view notifications.

NOTE: If you are viewing the map, notifications appear in a map tool.

- To ignore a notification, select **OK**.
The popup closes, but the notification remains active on your phone.
- To view a notification, select **View**.
- To listen to the notification, select **View > Play**.
The device reads the notification using text-to-speech technology. This feature is not available for all languages.
- To perform additional actions, such as dismissing the notification from your phone, select **View**, and select an option.

NOTE: Additional actions are available for only some notification types and must be supported by the app generating the notification.

Receiving Notifications while Viewing the Map

WARNING

Do not read or reply to notifications while driving. If you do so, you could become distracted by the display, which could lead to an accident causing serious personal injury or death.

Before you can use this feature, your device must be connected to a supported phone running the Tread app ([Pairing Your Phone and Headset, page 32](#)).

When you are viewing the map, new notifications appear in a map tool at the edge of the screen. If the device is moving, you must verify you are a passenger and not the driver before you can view notifications.

- To ignore a notification, select **X**, or wait for popup to expire.
The popup closes, but the notification remains active on your phone.
- To view a notification, select the notification text.
- To listen to the notification, select **Play Message**.
The device reads the notification using text-to-speech technology. This feature is not available for all languages.
- To perform additional actions, such as dismissing the notification from your phone, select **View**, and select an option.

NOTE: Additional actions are available for only some notification types and must be supported by the app generating the notification.

Viewing the List of Notifications

You can view a list of all active notifications.

- 1 Select  > **Smart Notifications**.

The list of notifications appears. Unread notifications appear black, and previously read notifications appear gray.

- 2 Select an option:

- To view a notification, select the notification description.
- To listen to a notification, select .

The device reads the notification using text-to-speech technology. This feature is not available for all languages.

Hands-Free Calling

NOTE: While most phones and headsets are supported and can be used, a particular phone or headset cannot be guaranteed to be compatible. All features may not be available for your phone.

Using Bluetooth wireless technology, your device can connect to your compatible mobile phone and wireless headset or helmet to become a hands-free device. To check compatibility, go to www.garmin.com/bluetooth.

Placing a Call

- 1 Select  > **Phone**.

- 2 Select an option:

- To dial a number, select **Dial**, enter the phone number, and select **Dial**.
- To view numbers of recent, missed, or recently dialed or received calls, select **Call History**, select a log, select a number, and select **Call** to dial it.
- To call a contact from your phone book, select **Phone Book**, select a contact, and select **Call**.
- To call a point of interest location such as a restaurant or attraction, select **Browse Categories**, select a category, select a location, and select **Call**.

Calling Home

Before you can call home, you must enter a phone number for your home location.

Select  > **Phone** > **Call Home**.

Placing a Call Using Voice Dial



- 1 Select  > **Phone** > **Voice Dial**.

- 2 Listen for the voice prompt.

- 3 Say **Call**, and say the contact name, phone number, or location you want to call.

Using In-Call Options

In-call options appear on the map when you answer a call. Some options may not be compatible with your phone.

TIP: If you close the in-call options page, you can open it again by selecting  from any screen. You can also select  > **Phone** from the map.

- To set up a conference call, select **Add Call**.
- To transfer audio to your phone, select **Call in Progress on Navigator**.

TIP: You can use this feature if you want to disconnect the Bluetooth connection and remain on the call, or if you need privacy.

- To use the dial pad, select **Keypad**.

TIP: You can use this feature to use automated systems, such as voice mail.

- To mute the microphone, select **Mute**.
- To hang up, select **End Call**.

Setting Up Bluetooth Features for Your Apple® Device

By default, all compatible Bluetooth features are enabled when you pair your phone. You can enable, disable, or customize certain features.

Disabling Bluetooth Features (iPhone)

By default, all compatible Bluetooth features are enabled when you pair your phone. You can disable specific Bluetooth features and remain connected to the other features.

- 1 Select  > **Wireless Networks**.
- 2 Select an option:
 - To disable all Bluetooth features, clear the Bluetooth check box.
 - To disable hands-free calling, select the phone name, and clear the **Phone calls** check box.

Setting Up Bluetooth Features for Your Smartphone with Android™

By default, all compatible Bluetooth features are enabled when you pair your phone. You can enable, disable, or customize certain features.

Disabling Bluetooth Features (Android)

By default, all compatible Bluetooth features are enabled when you pair your phone. You can disable specific Bluetooth features and remain connected to the other features.

- 1 Select  > **Wireless Networks**.
- 2 Select an option:
 - To disable all Bluetooth features, clear the Bluetooth check box.
 - To disable only hands-free calling, select the phone name and clear the **Phone calls** check box.

Enabling or Disabling Bluetooth Features for Your Headset

By default, all compatible Bluetooth features are enabled when you pair your headset. You can enable or disable certain features.

- 1 Select  > **Wireless Networks**.
- 2 Select the headset name.
- 3 Select an option:
 - To disconnect the headset, clear the **Headset** check box.
 - To disable audio from streaming media, clear the **Media Audio** check box.

Disconnecting a Bluetooth Device

You can temporarily disconnect a Bluetooth device without deleting it from the paired devices list. The Bluetooth device can connect to your Tread device automatically in the future.

- 1 Select  > **Wireless Networks**.
- 2 Select the device to disconnect.
- 3 Select **Disconnect**.

Deleting a Paired Phone

You can delete a paired phone to prevent it from automatically connecting to your device in the future.

- 1 Select  > **Wireless Networks**.
- 2 Select the phone, and select **Forget Device**.

Street Navigation

Starting a Route

- 1 Select **Search**, and search for a location.
- 2 Select a location.
- 3 Select an option:
 - To start navigating using the recommended route, select **Go!**.
 - To choose an alternate route, select **Y**, and select a route.
Alternate routes appear to the right of the map.
 - To edit the course of the route, select **Y** > **Edit Route**, and add shaping points to the route ([Shaping Your Route, page 39](#)).

The device calculates a route to the location and guides you using voice prompts and information on the map ([Your Route on the Map, page 37](#)). A preview of the major roads in your route appears at the edge of the map for several seconds.

If you need to stop at additional destinations, you can add the locations to your route ([Adding a Location to Your Route, page 38](#)).

Starting a Route by Using the Map

You can start a route by selecting a location from the map.

- 1 Select **View Map**.
- 2 Drag and zoom the map to display the area to search.
- 3 Select a location on the map.
- 4 Select **Go!**.

Your Route on the Map

As you travel, the device guides you to your destination using voice prompts and information on the map. Instructions for your next turn or exit, or other actions appear across the top of the map.

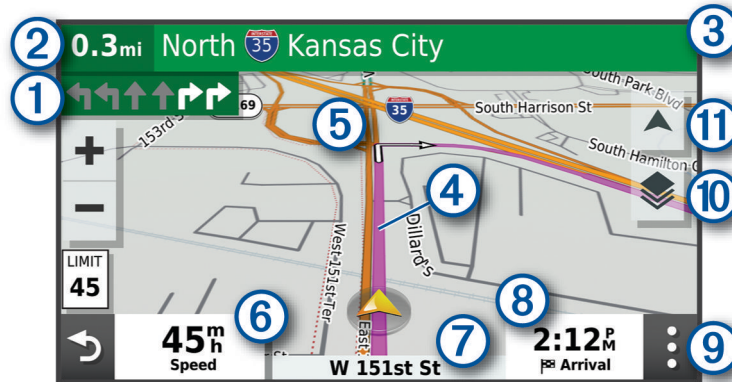

- ① Next action in the route. Indicates the next turn, exit, or other action and the lane in which you should travel, if available.
- ② Distance to the next action.
- ③ Name of the street or exit associated with the next action.
- ④ Route highlighted on the map.
- ⑤ Next action in the route. Arrows on the map indicate the location of upcoming actions.
- ⑥ Vehicle speed.
- ⑦ Name of the road on which you are traveling.
- ⑧ Estimated arrival time.
TIP: You can touch this field to change the information it shows.
- ⑨ Map tools. Provides tools to show you more information about your route and surroundings.
- ⑩ Map layers. Allows you to add map layers such as topographic and BirdsEye imagery to your map view.
- ⑪ Map perspective. Allows you to change the map perspective between track up, north up, and 3-D.

Active Lane Guidance

As you approach some turns, exits, or interchanges in your route, a detailed simulation of the road appears beside the map, if available. A colored line ① indicates the proper lane for the turn.

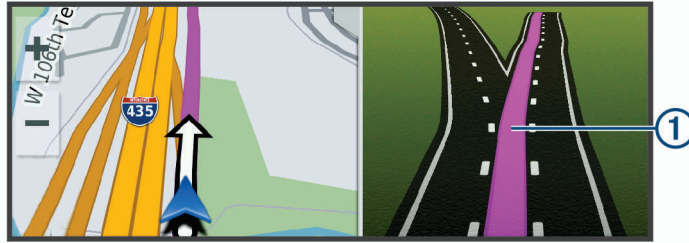

Viewing Turns and Directions

While navigating a route, you can view upcoming turns, lane changes, or other directions for your route.

- 1 From the map, select an option:
 - To view upcoming turns and directions as you navigate, select **⋮ > Turns**.
The map tool displays the next several turns or directions beside the map. The list updates automatically as you navigate the route.
 - To view the complete list of turns and directions for the entire route, select the text bar at the top of the map.
- 2 Select a turn or direction (optional).
Detailed information appears. An image of the junction may appear for junctions on major roadways, if available.

Viewing the Entire Route on the Map

- 1 While navigating a route, select anywhere on the map.
- 2 Select **📍**.

Changing Your Active Route

Adding a Location to Your Route

Before you can add a location to your route, you must be navigating a route ([Starting a Route, page 36](#)).

You can add locations to the middle or end of your route. For example, you can add a fuel station as the next destination in your route.

- 1 From the map, select **↶ > Search**.
- 2 Search for a location.
- 3 Select a location.
- 4 Select **Go!**.
- 5 Select an option:
 - To add the location as the next destination in your route, select **Add as Next Stop**.
 - To add the location to the end of your route, select **Add as Last Stop**.
 - To add the location and edit the order of destinations in your route, select **Add to Active Route**.

The device re-calculates the route to include the added location and guides you to the destinations in order.

Shaping Your Route

Before you can shape your route, you must start a route ([Starting a Route, page 36](#)).

You can manually shape your route to change its course. This allows you to direct the route to use a certain road or go through a certain area without adding a destination to the route.

1 Touch anywhere on the map.

2 Select **Shape Route**.

TIP: You can select  to zoom in on the map and select a more precise location.

The device enters route shaping mode and recalculates the route to travel through the selected location.

3 Select **Go!**.

4 If necessary, select an option:

- To add more shaping points to the route, select additional locations on the map.
- To remove a shaping point, select the shaping point and select **Remove**.

Avoiding Delays, Tolls, and Areas

Avoiding Traffic Delays on Your Route

Before you can avoid traffic delays, you must be receiving traffic information.

By default, the device optimizes your route to avoid traffic delays automatically. If you have disabled this option in the traffic settings ([Traffic Settings, page 55](#)), you can view and avoid traffic delays manually.

1 While navigating a route, select  > **Traffic**.

2 Select **Alternate Route**, if available.

3 Select **Go!**.

Avoiding Toll Roads

Your device can avoid routing you through areas that require tolls, such as toll roads, toll bridges, or congestion areas. The device may still include a toll area in your route if no other reasonable routes are available.

1 Select  > **Navigation**.

2 Select an option:

NOTE: The menu changes based on your area and the map data on your device.

- Select **Toll Roads**.
- Select **Tolls and Fees > Toll Roads**.

3 Select an option:

- To be asked each time before routing through a toll area, select **Always Ask**.
- To always avoid tolls, select **Avoid**.
- To always allow tolls, select **Allow**.

4 Select **Save**.

Avoiding Toll Stickers

If the map data on your device contains detailed toll sticker information, you can avoid or allow roads that require toll stickers for each country.

NOTE: This feature is not available in all areas.

- 1 Select  > **Navigation** > **Tolls and Fees** > **Toll Stickers**.
- 2 Select a country.
- 3 Select an option:
 - To be asked each time before routing through an area that requires toll stickers, select **Always Ask**.
 - To always avoid roads that require toll stickers, select **Avoid**.
 - To always allow roads that require toll stickers, select **Allow**.
- 4 Select **Save**.

Avoiding Road Features

- 1 Select  > **Navigation** > **Avoidances**.
- 2 Select the road features to avoid on your routes, and select **Save**.

Custom Avoidances

Custom avoidances allow you to select specific areas or sections of road to avoid. When the device calculates a route, it avoids these areas and roads unless no other reasonable route is available.

Avoiding a Road



- 1 Select  > **Navigation** > **Custom Avoidances**.
- 2 If necessary, select **Add Avoidance**.
- 3 Select **Add Avoid Road**.
- 4 Select the starting point of the section of road to avoid, and select **Next**.
- 5 Select the ending point of the road section, and select **Next**.
- 6 Select **Done**.

Avoiding an Area



- 1 Select  > **Navigation** > **Custom Avoidances**.
- 2 If necessary, select **Add Avoidance**.
- 3 Select **Add Avoid Area**.
- 4 Select the upper-left corner of the area to avoid, and select **Next**.
- 5 Select the lower-right corner of the area to avoid, and select **Next**.
The selected area is shaded on the map.
- 6 Select **Done**.

Disabling a Custom Avoidance

You can disable a custom avoidance without deleting it.

- 1 Select  > **Navigation** > **Custom Avoidances**.
- 2 Select an avoidance.
- 3 Select  > **Disable**.

Deleting Custom Avoidances

- 1 Select  > **Navigation** > **Custom Avoidances** > .
- 2 Select an option:
 - To delete all custom avoidances, select **Select All** > **Delete**.
 - To delete one custom avoidance, select the avoidance, and select **Delete**.

Arriving at Your Destination

When you approach your destination, the device provides information to help you complete your route.

-  indicates the location of your destination on the map, and a voice prompt announces you are approaching your destination.
- When you approach some destinations, the device automatically prompts you to search for parking. You can select Yes to find nearby parking areas (*Parking Near Your Destination*, page 42).
- When you stop at your destination, the device automatically ends the route. If the device does not detect your arrival automatically, you can select Stop to end your route.

Changing the Route Calculation Mode

- 1 Select  > **Navigation** > **Calculation Mode**.
- 2 Select an option:
 - Select **Faster Time** to calculate routes on streets that are faster to drive but can be longer in distance.
 - Select **Straight Line** to calculate off-road, point-to-point routes in a straight line.
 - Select **Shorter Distance** to calculate routes on streets that are shorter in distance but can take more time to drive.

Taking a Route Using Garmin Adventurous Routing™

Your device can calculate adventurous routes that prefer curvy roads, hills, and fewer highways. This feature can provide a more enjoyable ride, but it may increase the time or distance to your destination. The Garmin Adventurous Routing feature is not compatible with off-road trails.

NOTE: This feature is not available on all device models or for all map regions.

- 1 Select **Search** > **Categories**.
- 2 If necessary, select a subcategory.
- 3 Select a location.
- 4 Select .
- 5 Use the slider to increase or decrease the level of adventure of your route.
- 6 Select **Go!**

Taking a Detour

You can take a detour for a specified distance along your route or detour around specific roads. This is useful if you encounter construction zones, closed roads, or poor road conditions.

- 1 From the map, select  > **Edit Route**.
- 2 Select an option:
 - To detour your route for a specific distance, select **Detour by Distance**.
 - To detour around a specific road on the route, select **Detour by Road**.

Going Home

The first time you start a route home, the device prompts you to enter your home location.

- 1 Select **Search** > **Go Home**.
- 2 If necessary, enter your home location.

Editing Your Home Location

- 1 Select **Search** >  > **Set Home Location**.
- 2 Enter your home location.

Parking Near Your Destination

Your device can help you find a parking spot near your destination. When you approach some destinations, the device automatically prompts you to search for parking.

1 Select an option:

- When the device prompts you, select **Yes** to search for nearby parking.
- If the device does not prompt you, select **Search > Categories > Parking**, and select  > **My Destination**.

2 Select a parking location, and select **Go!** > **Add as Next Stop**.

The device guides you to the parking area.

Traffic

NOTICE

Garmin is not responsible for the accuracy or timeliness of the traffic information.

Your device can provide information about traffic on the road ahead or on your route. You can set your device to avoid traffic when calculating routes, and to find a new route to your destination if a large traffic delay occurs on your active route ([Traffic Settings, page 55](#)). The traffic map allows you to browse the map for traffic delays in your area.

To provide traffic information, your device must be receiving traffic data.

- All product models can receive subscription-free traffic data using the Tread app.

Traffic data is not available in all areas. For information about traffic coverage areas, go to garmin.com/traffic.

Receiving Traffic Data Using Your Smartphone

Your device can receive subscription-free traffic data while connected to a smartphone running the Tread app.



- 1 Connect your device to the Tread app ([Pairing Your Phone and Headset, page 32](#)).
- 2 On your Tread device, select  > **Traffic**, and verify the **Traffic** option is selected.

Viewing Traffic on the Map

The traffic map shows color-coded traffic flow and delays on nearby roads.

- 1 From the main menu, select  > **Traffic**.
- 2 If necessary, select  > **Legend** to view the legend for the traffic map.

Searching for Traffic Incidents

- 1 From the main menu, select  > **Traffic**.
- 2 Select  > **Incidents**.
- 3 Select an item in the list.
- 4 If there is more than one incident, use the arrows to view additional incidents.

Finding and Saving Locations

The maps loaded in your device contain locations, such as restaurants, hotels, auto services, and detailed street information. The Search menu helps you find your destination by providing several methods to browse, search, and save this information.

From the main menu, select **Search**.

- To quickly search all locations on your device, select **Search** (*Finding a Location Using the Search Bar, page 43*).
- To find an address, select **Address**.
- To browse or search pre-loaded points of interest by category, select **Categories** (*Finding a Location by Category, page 44*).
- To search near a different city or area, select  next to the current search area (*Changing the Search Area, page 46*).
- To view and edit your saved locations, select **Saved** (*Saving Locations, page 50*).
- To view locations you have recently selected from the search results, select **Recent** (*Viewing Recently Found Locations, page 49*).
- To search for RV parks and campgrounds, select **Ultimate Public Campgrounds** (*Finding Ultimate Campgrounds Points of Interest, page 48*).
- To browse and search Tripadvisor® points of interest and reviews, select **Tripadvisor** (*Finding Tripadvisor Points of Interest, page 48*).
- To browse and search HISTORY® points of interest, photos, and information, select **HISTORY®** (*Finding HISTORY Points of Interest, page 47*).
- To find national parks and explore park maps, select **National Parks** (*Finding National Parks, page 48*).
- To navigate to specific geographic coordinates, select **Coordinates** (*Finding a Location Using Coordinates, page 47*).

Finding a Location Using the Search Bar

You can use the search bar to search for locations by entering a category, brand name, address, or city name.

- 1 Select **Search**.
- 2 Select **Search** in the search bar.
- 3 Enter all or part of the search term.
Suggested search terms appear below the search bar.
- 4 Select an option:
 - To search for a type of business, enter a category name (for example, "movie theaters").
 - To search for a business name, enter all or part of the name.
 - To search for an address near you, enter the house number and street name.
 - To search for an address in another city, enter the house number, street name, city, and state.
 - To search for a city, enter the city and state.
 - To search for coordinates, enter latitude and longitude coordinates.
- 5 Select an option:
 - To search using a suggested search term, select the term.
 - To search using the text you entered, select **Q**.
- 6 If necessary, select a location.

Points of Interest

A point of interest is a place that you may find useful or interesting. Points of interest are organized by category and can include popular travel destinations such as gas stations, restaurants, hotels, and entertainment venues.



Finding a Location by Category

- 1 Select **Search**.
- 2 Select a category, or select **Categories**.
- 3 If necessary, select a subcategory.
- 4 Select a location.

Navigating to Points of Interest Within a Venue

NOTE: This feature may not be available in all areas or for all product models.

You can create a route to a point of interest (POI) within a larger venue, such as a store in a shopping mall or a specific terminal in an airport.

- 1 Select **Search** > **Search**.
- 2 Enter the name of the venue, and select .
- 3 Select the venue, and select .
- 4 Select **Explore this Venue**, and select a category such as restaurants, car rentals, or terminals to view locations within the venue.
- 5 Select the POI, and select **Go!**.

The device creates a route to the parking area or venue entrance closest to the POI. When you arrive at the destination, a checkered flag indicates the recommended parking area. A labeled point indicates the location of the POI within the venue.

Viewing Your Garmin Explore Points of Interest

- 1 From the main menu, select **Explore**.
- 2 Select a data type.
- 3 Select an item to view the details.

Synchronizing Garmin Explore Account Data

Before you can synchronize account data, you must connect to the Tread app and enable Garmin Explore.

You can synchronize data, such as tracks, with your Garmin Explore account. This can be helpful to keep your data available on each of your compatible devices. Your device periodically synchronizes data with your account automatically. You can also synchronize data manually at any time.

- 1 From the main menu, select **Explore**.
- 2 Select  > **Sync Explore Data**.

Location Search Results

By default, the location search results appear in a list, with the nearest location at the top. You can scroll down to view more results.

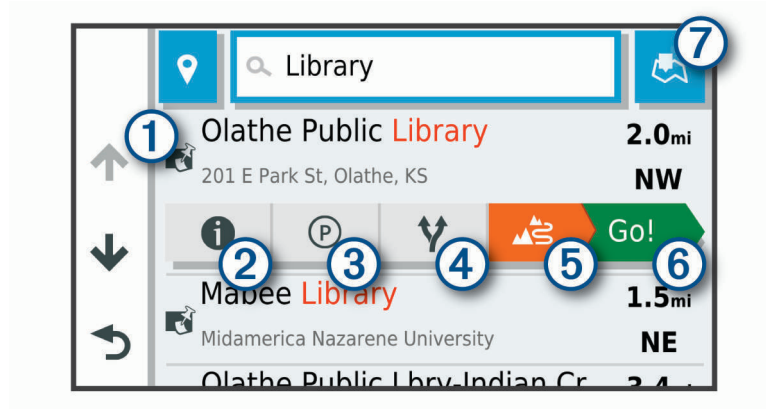

①	Select a location to view the option menu.
② i	Select to view detailed information about the selected location.
③ P	Select to find parking areas near the location.
④ Y	Select to view alternate routes to the locations.
⑤ ▲S	Select to start navigating to the location using Garmin Adventurous Routing.
⑥ Go!	Select to start navigating to the location using the recommended route.
⑦ 📍	Select to view the search results on the map.

Location Search Results on the Map

You can view the results of a location search on the map instead of in a list.

From the location search results, select . The nearest location appears at the center of the map, and basic information about the selected location appears at the bottom of the map.



①	Drag the map to view additional search results.
②	Additional search results. Select to view another location.
③	Selected location summary. Select to view detailed information about the selected location.
④ Go!	Select to start navigating to the location using the recommended route.
⑤ 	Select to view the search results in a list.

Changing the Search Area

By default, the device searches near your current location. You can also search other areas, such as near your destination, near another city, or along your active route.

- 1 Select **Search**.
- 2 Select .
- 3 Select an option.

Finding Parking Near Your Current Location

- 1 Select **Search > Parking**.
- 2 Select a parking location.
- 3 Select **Go!**.

Finding Parking Near a Specified Location

- 1 Select **Search**.
- 2 Search for a location.
- 3 From the location search results, select a location.
- 4 Select .
- A list of parking areas near the selected location appears.
- 5 Select a parking location.
- 6 Select **Go!**.

Search Tools

Search tools allow you to search for specific types of locations by responding to on-screen prompts.

Finding an Address

NOTE: The order of the steps may change depending on the map data loaded on your device.

- 1 Select **Search**.
- 2 If necessary, select  to search near a different city or area.
- 3 Select **Address**.
- 4 Follow the on-screen instructions to enter address information.
- 5 Select the address.

Finding an Intersection

You can search for an intersection or junction between two streets, highways, or other roads.

- 1 Select **Search > Intersections**.
- 2 Follow the on-screen instructions to enter street information.
- 3 Select the intersection.

Finding a Location Using Coordinates



You can find a location using latitude and longitude coordinates.

- 1 Select **Search > Coordinates**.
- 2 If necessary, select  and change the coordinate format or datum.
- 3 Enter the latitude and longitude coordinates.
- 4 Select **View on Map**.

Finding Fuel Stations and Prices

Before you can use this feature, your device must be connected to a supported phone running the Tread app ([Pairing Your Phone and Headset, page 32](#)).

You can find nearby fuel stations and compare fuel prices.

- 1 Select  > **Fuel Prices**.
- 2 If necessary, select  > **Fuel Type**, select a fuel type, and select **Save**.
- 3 Select a fuel station.

Finding HISTORY Points of Interest

NOTE: This feature is not available on all product models or for all map regions.

Your device includes HISTORY points of interest, which allow you to find and learn about historically significant locations and attractions, such as historic buildings, monuments, museums, and notable locations of historic events.

- 1 Select **Search > HISTORY®**.
- 2 Select a category.
- 3 Select a location.
- 4 Select  to view a photo and a short summary of the location's history.

Finding National Parks

Device models that include maps for North America or the United States also include detailed information for national parks in the United States. You can navigate to a national park or to a location within a national park.

1 Select **Search > National Parks**.

A list of national parks appears, with the nearest park at the top.

2 Select **Search**, and enter all or part of the park name to narrow the results (optional).

3 Select a national park.

A list of categories for locations of features and amenities within the park appears below the park name.

4 Select an option:

- To start navigating to the park, select **Go!**.
- To view more park information or explore the park features and amenities, select **i**.
- To quickly find a location within the park, select a category from the list below the park name, and select a location.

Finding Ultimate Campgrounds Points of Interest

NOTE: This feature is not available in all areas.

Your device includes Ultimate Campgrounds points of interest, which allow you to find public campgrounds near your location.

1 Select **Search > Ultimate Public Campgrounds**.

2 If necessary, select **Search Filters**, select one or more search filters, and select **Search**.

3 Select a location.

Finding iOverlander™ Points of Interest

NOTICE

You are responsible for understanding and complying with any applicable regulations associated with campsites and points of interest.

Your device includes iOverlander points of interest, which allow you to find points of interest useful for overlanding, such as camp sites, repair services, and lodging.

1 Select **Search > iOverlander**.

2 Select a category.

3 Select a location.

Finding Powersport Points of Interest

Your device includes powersport points of interest, which allow you to find points of interest useful for powersports, such as vehicle dealers and shops.

1 Select **Search > Powersport Locations**.

2 Select a location.

Tripadvisor

Your device includes Tripadvisor points of interest and ratings. Tripadvisor ratings appear automatically in the search results list for applicable points of interest. You can also search for nearby Tripadvisor points of interest and sort by distance or popularity.

Finding Tripadvisor Points of Interest

1 Select **Search > Tripadvisor**.

2 Select a category.

A list of nearby Tripadvisor points of interest for the category appears.

3 Select **Sort Results** to sort the search results by distance or popularity (optional).

Viewing Recently Found Locations

Your device stores a history of the last 50 locations you have found.

Select **Search** > **Recent**.

Clearing the List of Recently Found Locations

Select **Search** > **Recent** >  > **Clear** > **Yes**.

Viewing Current Location Information

You can use the Where Am I? page to view information about your current location. This feature is helpful if you need to tell emergency personnel your location.

From the map, select the vehicle.

Finding Emergency Services and Fuel

You can use the Where Am I? page to find the nearest hospitals, police stations, and fuel stations.

1 From the map, select the vehicle.

2 Select **Hospitals**, **Police Stations**, **Fuel**, or **Roadside Assist**.

NOTE: Some service categories are not available in all areas.

A list of locations for the selected service appears, with the nearest locations at the top.

3 Select a location.

4 Select an option:

- To navigate to the location, select **Go!**.
- To view the phone number and other location details, select .

Getting Directions to Your Current Location

If you need to tell another person how to get to your current location, your device can give you a list of directions.

1 From the map, select the vehicle.

2 Select  > **Directions to Me**.

3 Select a starting location.

4 Select **Select**.

Adding a Shortcut

You can add shortcuts to the Where To? menu. A shortcut can point to a location, a category, or a search tool.

The Where To? menu can contain up to 36 shortcut icons.

1 Select **Search** > **Add Shortcut**.

2 Select an item.

Removing a Shortcut

1 Select **Search** >  > **Remove Shortcut(s)**.

2 Select a shortcut to remove.

3 Select the shortcut again to confirm.

4 Select **Done**.

Saving Locations



Saving a Location

- 1 Search for a location (*Finding a Location by Category*, page 44).
- 2 From the search results, select a location.
- 3 Select  > **Save**.
- 4 Enter a name, and select **Done**.

Saving Your Current Location

- 1 From the map, select the vehicle icon.
- 2 Select **Save**.
- 3 Enter a name, and select **Done**.
- 4 Select **OK**.



Editing a Saved Location

- 1 Select **Search > Saved**.
- 2 If necessary, select a category.
- 3 Select a location.
- 4 Select .
- 5 Select  > **Edit**.
- 6 Select an option:
 - Select **Name**.
 - Select **Phone Number**.
 - Select **Categories** to assign categories to the saved location.
 - Select **Map Symbol** to change the symbol used to mark the saved location on a map.
- 7 Edit the information.
- 8 Select **Done**.

Assigning Categories to a Saved Location

You can add custom categories to organize your saved locations.

NOTE: Categories appear in the saved locations menu after you have saved at least 12 locations.

- 1 Select **Search > Saved**.
- 2 Select a location.
- 3 Select .
- 4 Select  > **Edit > Categories**.
- 5 Enter one or more category names, separated by commas.
- 6 If necessary, select a suggested category.
- 7 Select **Done**.

Deleting a Saved Location

NOTE: Deleted locations cannot be recovered.

- 1 Select **Search > Saved**.
- 2 Select  > **Delete Saved Places**.
- 3 Select the box next to the saved locations to delete, and select **Delete**.

Rider Awareness Features and Alerts

⚠ CAUTION

The rider alerts and speed limit features are for information only and do not replace your responsibility to abide by all posted speed limit signs and to use safe driving judgment at all times. Garmin is not responsible for any traffic fines or citations you receive for failing to follow all applicable traffic laws and signs.

Your device provides features that can help encourage safer riding, even when you are riding in a familiar area. The device plays an audible tone or message and displays information for each alert. You can enable or disable the audible tone or message for each type of alert. Not all alerts are available in all areas.

School zone or nearby school: The device plays a tone and displays the distance to and speed limit (if available) for an upcoming school or school zone.

Speed limit reduction: The device plays a tone and displays the upcoming reduced speed limit so you can be prepared to reduce your speed.

Speeding alert: The device plays a tone and displays a red border on the speed limit icon when you exceed the posted speed limit for the current road.

Railroad crossing: The device plays a tone and displays the distance to an upcoming railroad crossing.

Animal crossing: The device plays a tone and displays the distance to an upcoming animal crossing area.

Curve: The device plays a tone and displays the distance to a curve in the road.

Slower traffic: The device plays a tone and displays the distance to slower traffic when you approach slower traffic at a higher speed. Your device must be receiving traffic information to use this feature.

Enabling or Disabling Rider Alerts

You can turn off individual audible rider alerts. Visual alerts appear even when the audible alert is disabled.

- 1 Select  > **Driver Assistance** > **Rider Alerts**.
- 2 Select or clear the check box next to each alert.

Red Light and Speed Cameras

NOTICE

Garmin is not responsible for the accuracy of or the consequences of using a red light or speed camera database.

NOTE: This feature is not available for all regions or product models.

Information about red light and speed camera locations is available in some areas for some product models. The device alerts you when you approach a reported speed or red light camera.

- In some areas, your device can receive live red light and speed camera data while connected to a smartphone running the Tread app.
- You can use the Garmin Express™ software (garmin.com/express) to update the camera database stored on your device. You should update your device frequently to receive the most up-to-date camera information.

Fuel Tracking

You can set your device to estimate your fuel usage, warn you when you approach the maximum estimated fuel distance, and suggest fuel stops based on your estimated fuel range. When fuel tracking is enabled,  indicates the current fuel status.

White: Fuel tracking is disabled, or the device is not connected to the mount.

Green: The estimated fuel range is above the fuel tank warning level.

Yellow: The estimated fuel range is below the fuel tank warning level.

Red: The estimated distance remaining on the tank is 0.

Enabling Fuel Tracking

Before you can enable fuel tracking, the device must be in ATV, side-by-side, snowmobile, or motorcycle mode and placed in the mount.

When you enable fuel tracking, a fuel gauge appears on the trip computer ([Viewing the Trip Information Page, page 19](#)).

- 1 Fill your fuel tank.
- 2 Select  > **Fuel Settings** > **Fuel Tracking**.
- 3 Select **Distance Per Tank**.
- 4 Enter the distance the vehicle travels on a tank of gas and select **Done**.

Setting a Low Fuel Warning

You can set the device to warn you when the tank is low on fuel.

NOTE: The device must be connected to the mount to give low fuel warnings.

- 1 Enable fuel tracking ([Enabling Fuel Tracking, page 52](#)).
- 2 Select **Remaining Fuel Warning**.
- 3 Enter a distance, and select **Done**.

When you have only enough fuel left to travel the distance you entered, a low fuel warning appears on the map page.

Resetting the Fuel Tank Mileage

When you refill your fuel tank, you should reset the fuel tank mileage on your device to more accurately track your remaining fuel.

Select  > **Fuel Settings** > **Reset Fuel Tank**.

Viewing Helmet Law Notifications

While you are using a motorcycle vehicle profile, helmet law and eye protection notifications may appear on your Tread device. Notifications appear the first time your device acquires satellites and when your device approaches a location with motorcycle safety rules.

NOTICE

Garmin recommends that all riders wear helmets for safety. Helmet law notifications are for reference only, are subject to change, and are not intended to be considered legal advice. Helmet law notifications are available in the U.S. and Canada only.

Select the notification to view more details.

Searching for Helmet Laws

You can search for helmet laws by state or province.

- 1 Select  > **Helmet Guide**.
- 2 Select a state or province.

Settings

Map and Vehicle Settings

Select  > **Map Display**.

Map Vehicle Icon: Sets the vehicle icon that represents your position on the map.

Driving Map View: Sets the perspective on the map.

Map Detail: Sets the level of detail on the map. More detail may cause the map to draw slower.

Street Map Theme: Changes the color of the map data.

Map Layers: Sets the data that appears on the map page (*Customizing the Map Layers*, page 20).

Auto Zoom: Automatically selects the zoom level for optimal use of your map. When disabled, you must zoom in or out manually.

Skip Next Stop Confirmation: Sets a confirmation message to appear when skipping a location on your route.

myMaps: Sets which installed maps the device uses.

Enabling Maps

You can enable map products installed on your device.

TIP: To purchase additional map products, go to <http://buy.garmin.com>.

1 Select  > **Map Display** > **myMaps**.

2 Select a map.

Navigation Settings

Select  > **Navigation**.

Calculation Mode: Sets the route calculation method.

Off-Route Recalculation: Sets recalculation preferences when navigating away from an active route.

Avoidances: Sets road features to avoid on a route.

Custom Avoidances: Allows you to avoid specific roads or areas.

Toll Roads: Sets preferences for avoiding toll roads.

Tolls and Fees: Sets preferences for avoiding toll roads and toll stickers.

NOTE: This feature is not available in all areas.

Environmental Zones: Sets the avoidance preferences for areas with environmental or emissions restrictions that may apply to your vehicle.

Restricted Mode: Disables all functions that require significant operator attention.

GPS Simulator: Stops the device from receiving a GPS signal, and saves battery power.

Calculation Mode Settings

Select  > **Navigation** > **Calculation Mode**.

The route calculation is based on road speeds and vehicle acceleration data for a given route.

Faster Time: Calculates routes that are faster to drive but can be longer in distance.

Shorter Distance: Calculates routes that are shorter in distance but can take more time to drive.

Straight Line: Calculates a direct line from your location to your destination.

Setting a Simulated Location

If you are indoors or not receiving satellite signals, you can use the GPS simulator to plan routes from a simulated location.

- 1 Select  > **Navigation** > **GPS Simulator**.
- 2 From the main menu, select **View Map**.
- 3 Tap the map twice to select an area.
The address of the location appears at the bottom of the screen.
- 4 Select the location description.
- 5 Select **Set Location**.

Bluetooth Settings

Select  > **Wireless Networks**.

Bluetooth: Enables Bluetooth wireless technology.

Search for Devices: Searches for nearby Bluetooth devices.

Friendly Name: Allows you to enter a friendly name that identifies your device on other devices with Bluetooth wireless technology.

Wi-Fi Settings

The wireless network settings allow you to manage Wi-Fi networks.

Select  > **Wireless Networks**.

Wi-Fi: Enables the Wi-Fi radio.

Saved Networks: Allows you to edit or remove saved networks.

Search for Networks: Searches for nearby Wi-Fi networks ([Connecting to a Wi-Fi Network, page 57](#)).

Driver Assistance Settings

Select  > **Driver Assistance**.

Rider Alerts: Allows you to enable or disable alerts for upcoming zones or road conditions ([Rider Awareness Features and Alerts, page 51](#)).

Speeding Alert: Alerts you when you are exceeding the speed limit.

Reduced Speed Tone: Alerts you when the speed limit decreases.

Route Preview: Shows a preview of the major roads in your route when you start navigation.

Proximity Alerts: Alerts you when you approach speed cameras or red light cameras.

Display Settings

Select  > **Display**.

Orientation: Allows you to set the display to portrait (vertical) or landscape (horizontal).

NOTE: This feature is not available on all product models.

Color Mode: Allows you to select day or night color mode. If you select the Auto option, the device automatically switches to day or night colors based on the time of day.

Brightness: Allows you to adjust the display brightness.

Display Timeout: Allows you to set the amount of idle time before your device enters sleep mode while using battery power.

Screenshot: Allows you to take a picture of the device screen. Screenshots are saved in the Screenshot folder of the device storage.

Traffic Settings

From the main menu, select  > **Traffic**.

Traffic: Enables traffic.

Current Provider: Sets the traffic provider to use for traffic data. The Auto option selects the best available traffic data automatically.

Subscriptions: Lists the current traffic subscriptions.

Optimize Route: Enables the device to use optimized alternate routes automatically or upon request ([Avoiding Traffic Delays on Your Route, page 39](#)).

Traffic Alerts: Sets the traffic delay severity for which the device displays a traffic alert.

Units and Time Settings

To open the Units and Time settings page, from the main menu, select  > **Units & Time**.

Current Time: Sets the device time.

Time Format: Allows you to select a 12-hour, 24-hour, or UTC display time.

Units: Sets the unit of measure used for distances.

Position Format: Sets the coordinate format and datum used for geographical coordinates.

Setting the Time

1 From the main menu, select the time.

2 Select an option:

- To set the time automatically using GPS information, select **Automatic**.
- To set the time manually, drag the numbers up or down.

Language and Keyboard Settings

To open the Language and Keyboard settings, from the main menu, select  > **Language & Keyboard**.

Voice Language: Sets the language for voice prompts.

Text Language: Sets all on-screen text to the selected language.

NOTE: Changing the text language does not change the language of user-entered data or map data, such as street names.

Keyboard Language: Enables keyboard languages.

Device and Privacy Settings

Select  > **Device**.

About: Displays the software version number, the unit ID number, and information on several other software features.

Regulatory: Displays regulatory markings and information.

EULAs: Displays the end-user license agreements.

NOTE: You need this information when you update the system software or purchase additional map data.

Software Licenses: Displays software licensing information.



Device Data Reporting: Shares anonymous data to improve the device.

Travel History: Allows the device to store a record of the places you go. This allows you to view the trip log, use the Trip History feature, and use myTrends™ suggested routes.

Reset: Allows you to clear your travel history, reset settings, or delete all user data.

Restoring Settings

You can restore a category of settings or all settings to the factory default values.

- 1 Select .
- 2 If necessary, select a settings category.
- 3 Select  > **Restore**.

Device Information

Viewing E-label Regulatory and Compliance Information

- 1 From the settings menu, swipe to the bottom of the menu.
- 2 Select **Device** > **Regulatory**.

Tread Specifications

Water resistance	IEC 60529 IPX7 ¹
Operating temperature range	From -20° to 55°C (from -4° to 131°F)
Charging temperature range	From 0° to 45°C (from 32° to 113°F)
Power input (vehicle power cable, motorcycle, or external power)	From 12 to 24 Vdc
Battery type	Lithium-ion battery
Battery voltage range	From 3.5 to 4.1 V
Wireless frequencies/protocols	2.4 GHz @ 18 dBm maximum

Group Ride Specifications

Water resistance	IEC 60529 IPX7 ¹
Operating temperature range	From -20° to 55°C (from -4° to 131°F)
Charging temperature range	From 0° to 45°C (from 32° to 113°F)
Power input (vehicle power cable, motorcycle, or external power)	From 12 to 24 Vdc
Battery type	Lithium-ion battery
Battery voltage range	From 3.5 to 4.1 V
Wireless frequencies (United States)	From 151.82 to 154.6 MHz @ 31.7 dBm
Wireless frequencies (EMEA)	From 169.4125 to 169.4625 MHz @ 29.5 dBm
Wireless frequencies (New Zealand)	From 160.175 to 160.5750 MHz @ 22 dBm
Wireless frequencies (Australia)	From 151.15 to 152.15 MHz @ 17.3 dBm

¹ The device withstands incidental exposure to water of up to 1 m for up to 30 min. For more information, go to www.garmin.com/waterrating.

Charging the Device

NOTE: This Class III product shall be powered by an LPS power supply.

You can charge the battery in the device using any of these methods.

- Connect the device to an optional power adapter accessory, such as a wall power adapter.
You can purchase an approved Garmin AC-DC adapter suitable for home or office use from a Garmin dealer or www.garmin.com. The device may charge slowly when connected to a third-party adapter.

Device Maintenance

Garmin Support Center

Go to support.garmin.com for help and information, such as product manuals, frequently asked questions, videos, and customer support.

Map and Software Updates

For the best navigation experience, you should keep the maps and software on your device up to date.

Map updates provide the newest available changes to roads and locations in the maps used by your device. Keeping maps up to date helps your device find recently added locations and calculate more accurate routes. Map updates are large and may take several hours to complete.

Software updates provide changes and improvements to the device features and operation. Software updates are small and take a few minutes to complete.

You can update your device using two methods.

- You can connect the device to a Wi-Fi network to update directly on the device (recommended). This option allows you to update your device conveniently without connecting it to a computer.
- You can connect the device to a computer and update it using the Garmin Express application (garmin.com/express).

Connecting to a Wi-Fi Network

The first time you turn on the device, it prompts you to connect to a Wi-Fi network and register your device. You can also connect to a Wi-Fi network using the settings menu.

- 1 Select  > **Wireless Networks**.
- 2 If necessary, select **Wi-Fi** to enable Wi-Fi technology.
- 3 Select **Search for Networks**.
The device displays a list of nearby Wi-Fi networks.
- 4 Select a network.
- 5 If necessary, enter the password for the network, and select **Done**.

The device connects to the network, and the network is added to the list of saved networks. The device reconnects to this network automatically when it is within range.



Updating Maps and Software Using a Wi-Fi Network

NOTICE

Map and software updates may require the device to download large files. Regular data limits or charges from your Internet service provider apply. Contact your Internet service provider for more information about data limits or charges.

You can update the maps and software by connecting your device to a Wi-Fi network that provides access to the Internet. This allows you to keep your device up to date without connecting it to a computer.

- 1 Connect the device to a Wi-Fi network ([Connecting to a Wi-Fi Network, page 57](#)).

While connected to a Wi-Fi network, the device checks for available updates. When an update is available,  appears on the  icon in the main menu.

- 2 Select  > **Updates**.

The device checks for available updates. When an update is available, **Update Available** appears below Map or Software.

- 3 Select an option:

- To install all available updates, select **Install All**.
- To install only map updates, select **Map > Install All**.
- To install only software updates, select **Software > Install All**.

- 4 Read the license agreements, and select **Accept All** to accept the agreements.

NOTE: If you do not agree with the license terms, you can select **Reject**. This stops the update process. You cannot install updates until you accept the license agreements.

- 5 Using the included USB cable, connect the device to external power, and select **Continue** ([Charging the Device, page 57](#)).

For the best results, a USB wall charger that provides at least 1 A power output is recommended. Many USB power adapters for smartphones, tablets, or portable media devices may be compatible.

- 6 Keep the device connected to external power and within range of the Wi-Fi network until the update process is complete.

TIP: If a map update is interrupted or canceled before it completes, your device may be missing map data. To repair missing map data, you must update the maps again using either Wi-Fi or Garmin Express.

Product Updates

On your computer, install Garmin Express (www.garmin.com/express).

This provides easy access to these services for Garmin devices:

- Software updates
- Map updates
- Product registration

Updating Maps and Software with Garmin Express

You can use the Garmin Express application to download and install the latest map and software updates for your device.

- 1 If you do not have the Garmin Express application installed on your computer, go to garmin.com/express and follow the on-screen instructions to install it.
- 2 Open the  Garmin Express application.
- 3 Connect your device to your computer using a mini-USB cable.

The small end of the cable connects to the mini-USB port  on your Tread device, and the large end connects to an available USB port on your computer.

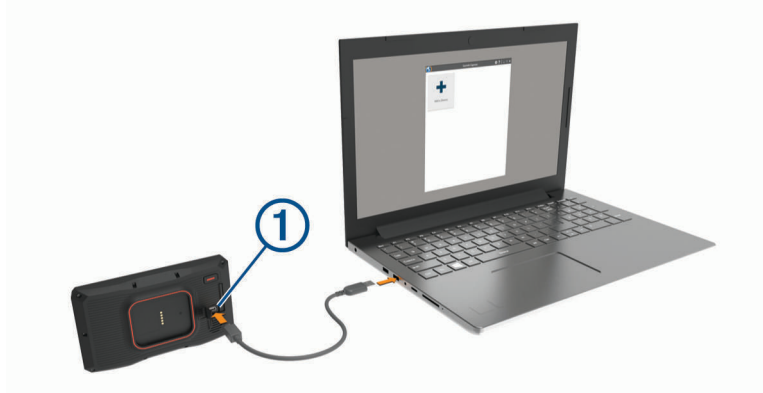

- 4 When your Tread device prompts you to enter file transfer mode, select **Yes**.
- 5 In the Garmin Express application, click **Add a Device**.
The Garmin Express application searches for your device and displays the device name and serial number.
- 6 Click **Add Device**, and follow the on-screen instructions to add your device to the Garmin Express application.
When setup is complete, the Garmin Express application displays the updates available for your device.

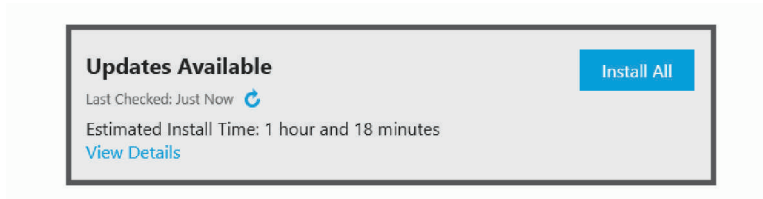

- 7 Select an option:
 - To install all available updates, click **Install All**.
 - To install a specific update, click **View Details**, and click **Install** next to the update you want.The Garmin Express application downloads and installs the updates onto your device. Map updates are very large, and this process may take a long time on slower internet connections.
NOTE: If a map update is too large for the internal storage of the device, the software may prompt you to install a microSD card in your device to add storage space ([Installing a Memory Card for Maps and Data, page 69](#)).
- 8 Follow the on-screen instructions during the update process to finish installing updates.
For example, during the update process, the Garmin Express application may instruct you to disconnect and reconnect your device.

Device Care

NOTICE

Avoid dropping your device.

Do not store the device where prolonged exposure to extreme temperatures can occur, because it can cause permanent damage.

Never use a hard or sharp object to operate the touchscreen, or damage may result.

Cleaning the Outer Casing

NOTICE

Avoid chemical cleaners and solvents that can damage plastic components.

- 1 Clean the outer casing of the device (not the touchscreen) using a cloth dampened with a mild detergent solution.
- 2 Wipe the device dry.

Cleaning the Touchscreen

- 1 Use a soft, clean, lint-free cloth.
- 2 If necessary, lightly dampen the cloth with water.
- 3 If using a dampened cloth, turn off the device and disconnect the device from power.
- 4 Gently wipe the screen with the cloth.

Avoiding Theft

- Remove the device and mount from sight when not in use.
- Remove the residue left on the windshield by the suction cup.
- Do not keep your unit in the glove compartment.
- Register your device using the Garmin Express software (garmin.com/express).

Restarting the Device

You can restart your device if it stops functioning.

Hold the power key for 12 seconds.

Removing the Device from the Mount

- 1 Press the release tab or button on the mount.
- 2 Tilt the top of the device downward, and lift the device from the mount.

Troubleshooting

My device is not acquiring satellite signals

- Take your device out of parking garages and away from tall buildings and trees.
- Remain stationary for several minutes.

My battery does not stay charged for very long

- Decrease the screen brightness (*Display Settings, page 54*).
- Shorten the display timeout (*Display Settings, page 54*).
- Decrease the volume (*Adjusting the Volume, page 3*).
- Turn off the wi-fi radio when it is not in use (*Wi-Fi Settings, page 54*).
- Put the device in power saving mode when not in use (*Turning the Device On or Off, page 1*).
- Keep your device away from extreme temperatures.
- Do not leave your device in direct sunlight.

My device does not connect to my phone

- Select  > **Wireless Networks**.
The Bluetooth option must be enabled.
- Enable Bluetooth wireless technology on your phone and bring your phone within 10 m (33 ft.) of the device.
- Verify your phone is compatible.
Go to www.garmin.com/bluetooth for more information.
- Complete the pairing process again.
To repeat the pairing process, you must unpair your phone and device (*Disconnecting a Bluetooth Device, page 35*), and complete the pairing process (*Pairing Your Phone and Headset, page 32*).

My device does not appear as a removable drive on my computer

On most computers, the device connects using Media Transfer Protocol (MTP). In MTP mode, the device appears as a portable device and not as a removable drive.

My device does not appear as a portable device on my computer

On Mac® computers and some Windows® computers, the device connects using USB mass storage mode. In USB mass storage mode, the device appears as a removable drive or volume, and not as a portable device. Windows versions prior to Windows XP Service Pack 3 use USB mass storage mode.

My device does not appear as either a portable device or a removable drive or volume on my computer

- 1 Disconnect the USB cable from your computer.
- 2 Turn off the device.
- 3 Connect the USB cable to your device and to a USB port on your computer.

TIP: The USB cable must connect to a USB port on your computer, not to a USB hub.

The device turns on automatically and goes into MTP mode or USB mass storage mode. A picture of the device connected to a computer appears on the device screen.

NOTE: If you have several network drives mapped on your computer, Windows may have trouble assigning drive letters to your Garmin drives. For information about assigning drive letters, see the help file for your operating system.

Appendix

Garmin PowerSwitch

⚠ WARNING

Garmin strongly recommends having an experienced installer with the proper knowledge of electrical systems install the device. Incorrectly wiring the power cable can result in damage to the vehicle or the battery and can cause bodily injury.

You can use a connected Garmin PowerSwitch device to control lights, fans, and more from your Tread device.

Mounting Considerations

- The device must be mounted close to the battery and within the range of the supplied power cable.
- The mounting surface must be strong enough to support the weight of the device.
- The location must allow room for the routing and connection of all cables.

Mounting the Device

Before you can mount the device, you must select a mounting location and purchase the appropriate hardware for your mounting surface.

NOTICE

Avoid wires, gauges, air bags, air bag covers, HVAC, and other items when drilling pilot holes and attaching the mount to the vehicle. Garmin is not responsible for any damages or consequences arising from the installation.

- 1 Place the mount on the selected location.



- 2 Using the mount as a template, mark the two screw locations ①.
- 3 Drill pilot holes (optional).
For some types of mounting material, drilling pilot holes is necessary. Do not drill through the mount.
- 4 Securely fasten the mount to the surface using the appropriate hardware for your mounting surface.

Opening the Front Cover

You must open the front cover to make electrical connections.

- 1 Lift the front cover latch ① and rotate it counter-clockwise.



- 2 Pull the front cover off of the device.



Connecting Accessories

NOTICE

Do not use the device to control or power a winch. Failure to follow this notice could cause damage to your vehicle or your device.

Accessory requirements:

- Verify the amperage rating of each accessory before wiring it to the Garmin PowerSwitch device. The device supports accessories up to 30 A for each channel and a maximum of 100 A for the entire system.
- Use 10 AWG (6 mm²) wires for accessories that use 20 to 30 A.
- Use 12 AWG (4 mm²) wires for accessories that use 10 to 20 A.
- Use 14 AWG (2.5 mm²) wires for accessories that use less than 10 A.
- Use the appropriate size terminals for all accessory connections.
- Crimp all terminal connectors securely.

- 1 Connect the positive wire from the accessory ① to one of the accessory terminals ② on the Garmin PowerSwitch device.

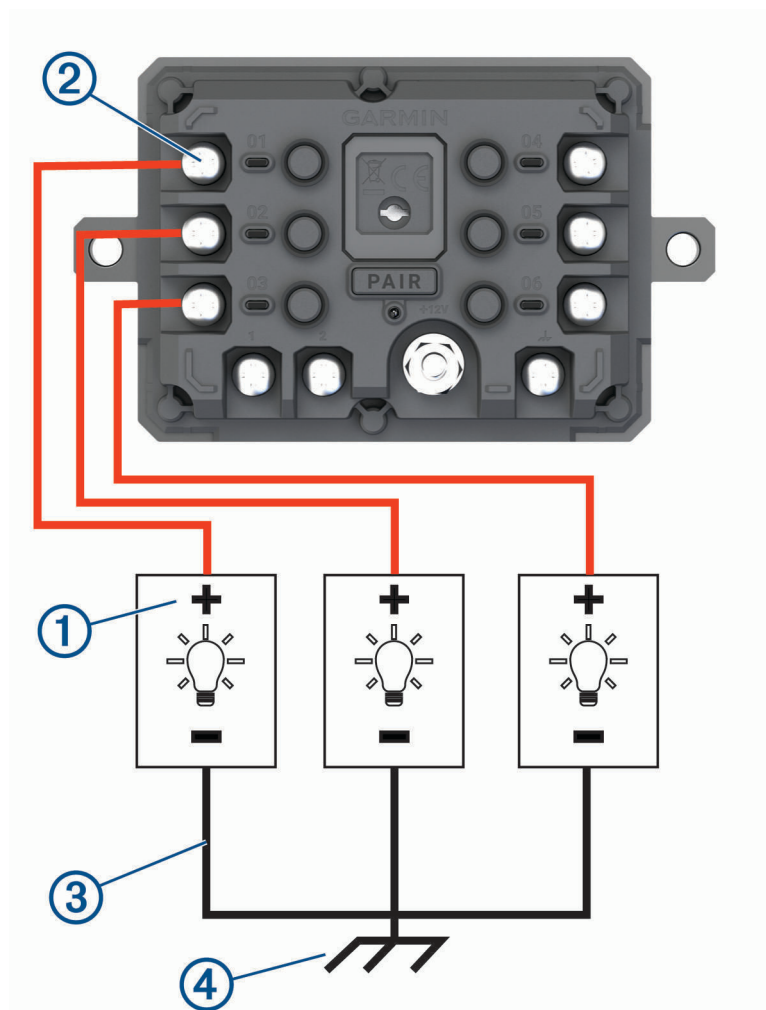

- 2 Connect the negative or ground wire ③ to an unpainted ground stud ④ on the vehicle frame, to a ground distribution block, or directly to the negative terminal on the battery.

NOTICE

Do not connect the accessory ground wires to the ground terminal (GND) on the Garmin PowerSwitch device. Failure to heed this notice could result in personal or property damage, or negatively impact device functionality.

Connecting a Control Input

You can connect to the control terminals to enable the Garmin PowerSwitch device to turn on customizable outputs. For example, you can connect your vehicle ignition switch to a control input terminal to turn on accessories automatically each time you start your vehicle. The control terminals detect a signal from 3.3 V to 18 V. You can configure output functions with the Garmin PowerSwitch app.

Connect the control wire from the control source in your vehicle to one of the two control terminals on the Garmin PowerSwitch device.

Connecting the Device to Vehicle Power

Before you can connect the device to vehicle power, you must remove the warning tag from the +12V terminal on the device.

You should always confirm all electrical connections are secure and will not come loose while operating the device.

- 1 Connect the large ring end of the included ground wire ① to the negative terminal on the vehicle battery.

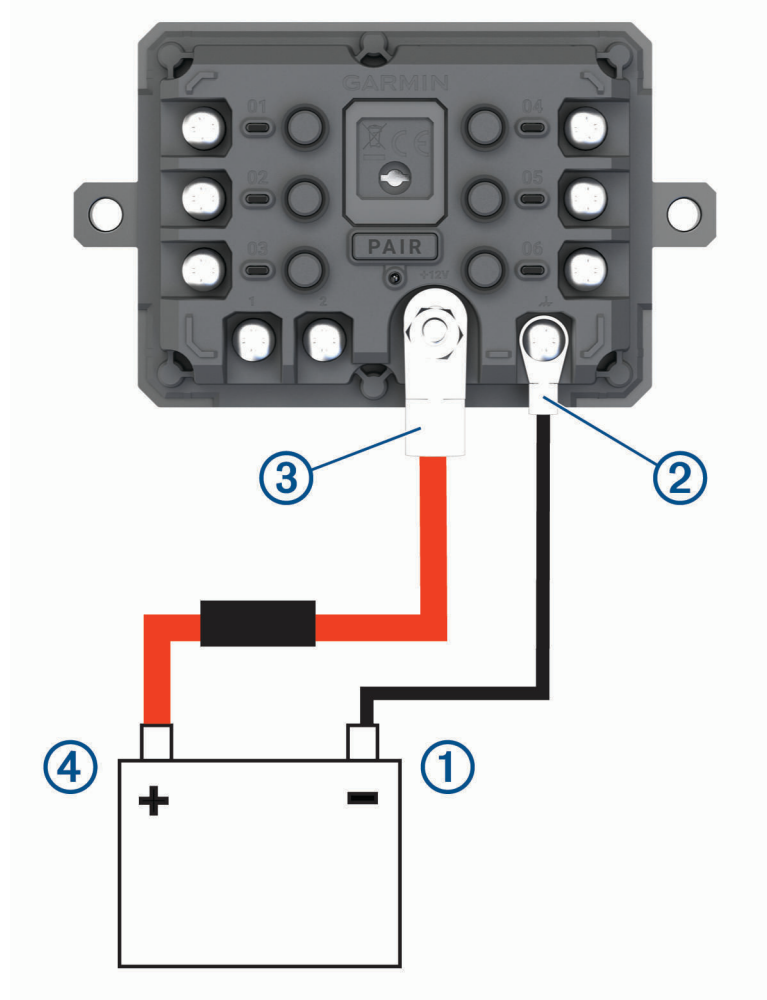

- 2 Connect the small ring end of the ground wire to the **GND** terminal ② on the device.
- 3 Connect the small ring end of the included 12V cable to the **+12V** terminal ③ on the device.
- 4 Tighten the $\frac{3}{8}$ in. nut on the +12V terminal to a maximum torque specification of 4.52 N-m (40 lbf-in.). You should confirm the nut cannot be loosened by hand.

NOTICE

Do not overtighten the +12V terminal to prevent damage to the terminal.

- 5 Connect the large ring end of the 12V cable ④ to the positive terminal on the vehicle battery.

Pairing with a Garmin Navigation Device

You can pair your Garmin PowerSwitch device with a compatible Garmin navigation device.

- 1 Turn on power to your Garmin PowerSwitch device, and place your compatible Garmin navigation device within 1 m (3.3 ft.) of it.
- 2 On your compatible navigation device, open the Garmin PowerSwitch app.
- 3 Follow the on-screen instructions to complete the pairing and setup process.

The main app dashboard appears. After the devices are paired, they connect automatically when they are turned on and within range.

Garmin PowerSwitch Specifications

Dimensions (D x W x H)	75 x 125 x 32 mm (2.95 x 4.92 x 1.26 in.)
Operating temperature range	From -25° to 85°C (from -13° to 185°F)
Wireless frequency	2.4 GHz @ 10 dBm
Power input	From 12 to 16 V using the included vehicle power cable.
Maximum accessory output	30 A
Maximum system output	100 A
Current draw with all outputs off	3 mA
Water rating	IEC 60529 IPX7 ¹

My Garmin PowerSwitch will not stay connected

- Verify the Garmin PowerSwitch device is receiving power.
- Verify that your vehicle's battery is supplying at least 12 V of power.
The Garmin PowerSwitch device turns off automatically to preserve your vehicle's battery if it is receiving less than 12 V.
- Verify that Bluetooth technology is enabled on your paired navigation device or smartphone.
- Move the navigation device or smartphone closer to your Garmin PowerSwitch device.

Wireless Cameras

Your device can display the video feed from one or more connected wireless cameras.

¹ The device withstands incidental exposure to water of up to 1 m for up to 30 min. For more information, go to www.garmin.com/waterrating.

Pairing the Camera with a Garmin Navigation Device

You can pair the camera with a compatible Garmin navigation device. For more information about compatible Garmin devices, go to the product page at garmin.com/bc40.

1 Update your navigation device to the latest software.

Your device may not support the BC 40 camera without the latest software. For more information about updating the software, see the owner's manual for your navigation device.

2 Install batteries in the camera.

The camera enters pairing mode automatically, and the LED flashes blue while the camera is in pairing mode. The camera remains in pairing mode for two minutes. If pairing mode expires, you can remove and reinstall the batteries.

3 Bring the compatible Garmin navigation device outside your vehicle and within 1.5 m (5 ft.) of the camera, and turn on the navigation device.

The device detects your camera automatically and prompts you to pair with it.

4 Select **Yes**.

TIP: If the navigation device does not detect the camera automatically, you can select  > **Wireless Cameras** > **Add New Camera** to pair with it manually.

The device pairs with your camera.

5 Enter a name for the camera (optional).

You should use a descriptive name that clearly identifies the location of the camera.

6 Select **Done**.

Viewing the Wireless Camera

WARNING

This device is intended to enhance situational awareness when used properly. If used improperly, you could become distracted by the display, which could lead to an accident causing serious personal injury or death. Always view the display at a glance when the vehicle is in motion to avoid becoming distracted.

From the home screen or the map, select .

Aligning the Guidance Lines

For the best reference, the guidance lines should be aligned to reflect the outside edges of the vehicle. You should align the guidance lines separately for each backup camera. When you change the camera angle, you should immediately align the guidance lines again.

- 1 Position your vehicle with the driver's side closely aligned to a curb, driveway, or parking stall lines.

TIP: It can be helpful to position the vehicle in the center of a parking stall, and then pull forward into the next stall. This allows you to use the parking stall lines at the rear of the vehicle as reference points for alignment.

- 2 From the paired Garmin navigation device, select **⚙️ > Wireless Cameras**.
- 3 Select the paired camera name, and select **Guidance Lines > Adjust Guidance Lines**.
- 4 Use the arrows in the corners of the screen to move the ends of the white, driver's-side guidance line. The guidance line should appear directly on top of the curb, driveway, or parking stall line.

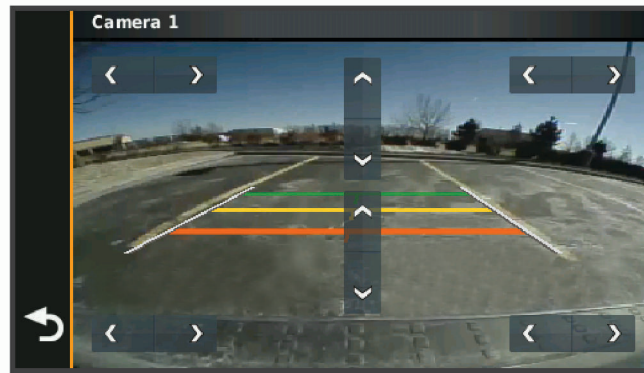

- 5 Use the arrows in the center of the screen to move the colored distance guidance lines up or down. The red guidance line should be aligned with the rearmost part of your vehicle. This could be the rear bumper, a trailer hitch, or another object protruding from the rear of the vehicle.
- 6 Reposition the vehicle with the passenger side closely aligned to a curb, driveway, or parking stall lines, and use the arrows to align the white, passenger-side guidance line. The guidance lines should be symmetrical.

Installing a Memory Card for Maps and Data

You can install a memory card to increase the storage space for maps and other data on your device. You can purchase memory cards from an electronics supplier, or go to www.garmin.com/maps to purchase a memory card with pre-loaded Garmin mapping software. The device supports microSD memory cards from 4 to 256 GB.

- 1 Locate the map and data memory card slot on your device (*Device Overview, page 1*).
- 2 Pull up the weather cap from the microSD card slot.
- 3 Slide the microSD card slot cover toward the edge of the device.



- 4 Pull the microSD card slot cover up.
- 5 Insert a microSD card into the slot.
NOTE: Confirm the microSD card fits flush against the card slot contacts.
- 6 Close the SD card cover.
- 7 Slide the SD card cover toward the center of the device.

Data Management

The device has a memory card slot for additional data storage.

NOTE: The device is compatible with Windows 7 and newer, and Mac OS 10.7 and newer.

About Memory Cards

You can purchase memory cards from an electronics supplier, or purchase pre-loaded Garmin mapping software (www.garmin.com). Memory cards can be used to store files such as maps and custom POIs.

Connecting the Device to Your Computer

You can connect the device to your computer using a USB cable.

- 1 Plug the small end of the USB cable into the port on the device.
- 2 Plug the larger end of the USB cable into a port on your computer.
- 3 When your Tread device prompts you to enter file transfer mode, select **Yes**.

A picture of your device connected to a computer appears on the device screen.

Depending on your computer operating system, the device appears as either a portable device, a removable drive, or a removable volume.

Transferring GPX Files From Your Computer

Apple computers may require additional third-party software, such as Android File Transfer, to read and write files on this device.

If you have already created routes that you want to use on your device, you can transfer GPX files directly from your computer.

- 1 Connect the device to your computer ([Connecting the Device to Your Computer, page 69](#)).
The device appears as a portable device.
- 2 On your computer, open the file browser.
- 3 Select a GPX file.
- 4 Select **Edit > Copy**.
- 5 Browse to the GPX folder on the device.
- 6 Select **Edit > Paste**.

Transferring Data From Your Computer

- 1 Connect the device to your computer ([Connecting the Device to Your Computer, page 69](#)).
Depending on your computer operating system, the device appears as either a portable device, a removable drive, or a removable volume.
- 2 On your computer, open the file browser.
- 3 Select a file.
- 4 Select **Edit > Copy**.
- 5 Browse to a folder on the device.
NOTE: For a removable drive or volume, you should not place files in the Garmin folder.
- 6 Select **Edit > Paste**.

Disconnecting the USB Cable

If your device is connected to your computer as a removable drive or volume, you must safely disconnect your device from your computer to avoid data loss. If your device is connected to your Windows computer as a portable device, it is not necessary to safely disconnect the device.

- 1 Complete an action:
 - For Windows computers, select the **Safely Remove Hardware** icon in the system tray, and select your device.
 - For Apple computers, select the device, and select **File > Eject**.
- 2 Disconnect the cable from your computer.

Adding BaseCamp™ Data to Garmin Explore

You can export your BaseCamp data files and import them to Garmin Explore for use with your Tread device.

- 1 Export your data from BaseCamp:
 - If you are using an Apple computer, see [Exporting Data from BaseCamp with an Apple Computer, page 71](#).
 - If you are using a PC, see [Exporting Data from BaseCamp with a PC, page 71](#).
- 2 Import your BaseCamp data to the Garmin Explore website ([Importing Data to Garmin Explore, page 71](#)).
- 3 Synchronize your Garmin Explore data with your Tread device ([Synchronizing Garmin Explore Account Data, page 44](#)).

Exporting Data from BaseCamp with a PC

- 1 Select an option:
 - To export all BaseCamp data stored on your computer, select **My Collection**, and select **File > Export > Export 'My Collection'**.
 - To export one or more items or a list, select one or more items or a list, and select **File > Export > Export Selection**.
- 2 Enter a name, select a location for the exported file, select the file format, and select **Save**.

Exporting Data from BaseCamp with an Apple Computer

- 1 Select an option:
 - To export all BaseCamp data stored on your computer, select **My Collection**, and select **File > Export 'My Collection'**.
 - To export one or more items or a list, select one or more items or a list, and select **File > Export Selected User Data**.
- 2 Enter a name.
- 3 Select a location for the exported file.
- 4 Select the file format.
- 5 Select **Export**.

Importing Data to Garmin Explore

- 1 Go to explore.garmin.com and log in to your account.
- 2 Select the **Map** tab.
- 3 Select .
- 4 Follow the on-screen instructions.

Viewing GPS Signal Status

Hold  for three seconds.

Purchasing Additional Maps

- 1 Go to your device product page at garmin.com.
- 2 Click the **Maps** tab.
- 3 Follow the on-screen instructions.

Index

Symbols

2-D map view **21**
3-D map view **21**

A

accessories **62**
active lane guidance **38**
addresses, finding **47**
alerts **11, 12**
 audio **54**
 proximity points **54**
altimeter **12**
app overview **27**
audio, proximity points **54**
avoidances
 area **40**
 deleting **40**
 disabling **40**
 road **40**
 road features **40**
 tolls **39, 40**

B

backup camera. See cameras
barometer **12**
battery
 charging **57**
 maximizing **61**
 problems **61**
Bluetooth **54**
Bluetooth technology **31, 32, 34, 61**
 disconnecting a device **35**
 pairing a headset **32**
 pairing a phone **32**
Bluetooth Technology **35**
 disabling calls **35**
 managing phones **35**
brightness **3**

C

calibrating, compass **12**
calls **34**
 home **34**
 placing **34**
camera
 pairing **67**
 viewing **67**
cameras **68**
 guidance lines **68**
 red light **51**
 speed **51**
changing the search area **46**
charging the device **57**
cleaning the device **60**
cleaning the touchscreen **60**
compass **12**
computer, connecting **61, 69**
connecting **57**
control input **28**
coordinates **47**
current location **49**
customizing **9**

D

data **70**
deleting
 paired Bluetooth device **35**
 trips **23**
destinations **26**. See locations
 arriving **41, 42**
detours **41**
device care **60**
directions **38**
disconnecting, Bluetooth device **35**

display settings **54**
dog, tracking **30, 31**
driving directions **38**

E

editing, saved trips **23**
elevation profile **20**
emergency services **49**
EULAs **55**
exit services **19**

F

files
 exporting **71**
 transferring **70**
finding locations. **43, 45–48** See also
 locations
 addresses **47**
 categories **44**
 cities **19**
 coordinates **47**
 intersections **47**
fuel
 prices **47**
 stations **49**
 tracking **51, 52**

G

Garmin Connect **31**
Garmin Explore **44**
Garmin Express, updating software **58, 59**
going home **41**
GPS **2, 71**
group ride **12–14**
guidance lines, aligning **68**

H

hands-free phone calls **32, 35**
headset **35**
 pairing **32**
helmet laws **52**
home
 calling **34**
 editing location **41**
 going **41**

I

icons **31**
 status bar **2**
ID number **55**
inReach **16**
inReach remote **16**
intersections, finding **47**

K

keyboard
 language **55**
 layout **55**

L

language
 keyboard **55**
 voice **55**
latitude and longitude **47**
location **46**
locations **26, 47**
 current **49, 50**
 recently found **49**
 saving **50**
 searching for **43, 47**
 simulated **54**
low-fuel warning **52**

M

map layers **11**
 customizing **20**
map view
 2-D **21**

3-D

21
maps **17, 19, 21, 22, 36, 53**
 BirdsEye imagery **22**
 data field **10, 19, 21, 37**
 detail level **53**
 layers **20, 21**
 purchasing **71**
 symbols **10, 37**
 theme **53**
 tools **18**
 updating **57–59**
 viewing routes **10, 31, 37, 38**
media player **22**
memory card **1, 69**
 installing **69**
message **16**
microSD card **1, 69**
mounting the device **4–7, 62–65**
 dashboard **8**
 removing from mount **9, 60**
music **21**

N

national parks **48**
navigation **10, 37, 41, 44**
 settings **53**
next turn **37**
notifications **32–34, 52**

O

on-screen buttons **2**
owner's manual **21**

P

pairing **30, 66**
 disconnecting **35**
 headset **32**
 phone **32, 61**
parking **42, 45, 46**
phone
 disconnecting **35**
 pairing **32, 61**
phone calls **34**
 answering **34**
 dialing **34**
 muting **34**
 voice dial **34**
pitch and roll **11, 12**
 calibrating **11**
points of interest (POI) **43, 44, 48, 70**
 HISTORY **47**
power cables **4, 57**
 vehicle **64, 65**
power key **1**
power switch **27**
 customizing **28–30**
product support **21**
profiles **4**

R

radio communication **14–16**
recently found locations **49**
red light cameras **51**
resetting
 device **60**
 trip data **20**
restoring settings **56**
rider alerts **51**
road conditions, weather **25**
routes **10, 26, 44**
 adding a point **38**
 adventurous routing **21, 41**
 calculating **41**
 calculation mode **23, 41, 53**
 shaping **39**
 starting **36, 45, 46**
 stopping **10**

viewing on the map **10, 37, 38**

S

satellite signals
acquiring **2**
viewing **71**
saved locations **24**
categories **50**
deleting **50**
editing **50**
saving, current location **50**
screen, brightness **3**
screenshots **54**
search bar **43**
settings **53–55**
setup **4**
shaping a route **39**
sharing **24**
shortcuts
adding **49**
deleting **49**
simulated locations **54**
sleep mode **1**
smartphone features **32**
disabling calls **35**
software
updating **57–59**
version **55, 60**
SOS **16**
canceling **17**
sending **17**
specifications **56, 66**
speed cameras **51**

T

theft, avoiding **60**
time settings **55**
tolls, avoiding **39**
tools, maps **18**
TracBack **24**
tracks **11**
traffic **20, 42, 55**
alternate route **39**
incidents **20, 42**
map **20, 42**
searching for delays **20, 42**
transportation modes **4**
changing **24**
travel history **55**
Tread, connecting **32**
trim ring **9**
trip information **19**
resetting **20**
viewing **19**
trip planner **22, 23**
editing a trip **23**
shaping points **23**
Tripadvisor **48**
troubleshooting **60, 61, 66**
turn list **38**

U

unit ID **55**
up ahead **18, 19**
customizing **19**
updating
maps **57–59**
software **57–59**
USB, disconnecting **70**

V

vehicle power cable **65**
vehicle profile **3, 4**
voice dial **34**
volume, adjusting **3**
VOX **15**

W

warning angle **12**
waypoints **44**
weather **25**
radar **25**
road conditions **25**
Where Am I? **49, 50**
Wi-Fi **54, 57, 58**
wireless devices **16**

