

# How to Use Your Cobra 29 LX OEM B

Contents	
Features	1
The CB Story	A1
FCC Regulations, FCC Warnings & Included Accessories	
Controls & Indicators	A2
Our Thanks to You	A3
Customer Support	
Installation	
Location & Mounting/Connection	2
Antennas	
CB Antenna & Marine Installation	6
Ignition Noise Interference	7
Operating Your 29 LX OEM B	
Turning On Your CB	8
Setting Channel Selector	9
Calibrate For SWR (Standing Wave Ratio)	10
To Receive	12
Selecting a Channel	13
S-Meter	13
To Transmit	14
Setting Dynamike®	15
Menu Mode	16
Setting the Clock	17
Setting the Alarm	17
Setting the Count Down Timer	18
Key Tones Mode	18
Radio Check Mode	19
Setting Display Color Mode	20
Setting Brightness Mode	21
Setting Contrast Mode	21
Weather Information	22
Weather Channels	23
Weather Alert Mode	24
Setting Weather Alert Scan	24
Setting Weather Auto Scan	24
Software version/Factory Settings	25
NB-ANL/Off (Noise Blanker/Automatic Noise Limiter Switch)	26
RF Gain Control	26
Program Memory Channels	27
Scan/Memory Scan	27
Scan CB Channels	28
Scan Memory Channels	28
Dimmer Control	28
Setting Squelch	29
S/RF Meter	30
External Speaker	31
Home And Office Set-Up	32
Temporary Mobile Set-Up	33
How Your CB Can Serve You	34
A Few Rules You Should Know	34
Channel 9 Emergency Messages	34
CB 10 Codes	36
Frequency Ranges	38
29 LX OEM B Specifications	39
FCC Statement	40
Warranty Information	42
Product Service	43
Ordering Info	44

## Features of This Product

- Selectable 4-Color LCD Display
- 10 Weather Channels
- Weather Scan
- Emergency Weather Alert
- 40 CB Radio Channels
- 40 Channel Scan
- Memory Channels
- Channel Frequency Read-Out
- Radio Check Diagnostic
- Clock/Timer/Alarm
- Heavy-Duty Dynamic Microphone
- Full 4 Watts AM RF Power Output
- SWR Calibration Meter
- Instant Channel 19 and 9
- Front Panel 4-Pin Microphone Connector
- Switchable Automatic Noise Limiter & Noise Blanker
- Adjustable Dynamike Boost
- Tactile Controls
- 9 Ft Mic Cord
- Programmable Dimmer Control
- RF Gain

## Location

### Location

Plan location of transceiver and microphone bracket before starting the installation.

Select a location that is convenient for operation, yet does not interfere with the driver or passenger.

The transceiver is usually mounted to the underside of the dash with the microphone bracket beside it.

## Mounting and Connection

### Note

The transceiver is held in the universal mounting bracket by two thumbscrews which allow for adjustment at a convenient angle.

The bracket includes two self-tapping screws and star washers. The mounting must be mechanically strong, conveniently located.

### Mounting and Connection

- 1 Hold the radio with the mounting bracket in the exact desired location. If there is no interference, remove the bracket and use it as a template to mark the location for the mounting screws.

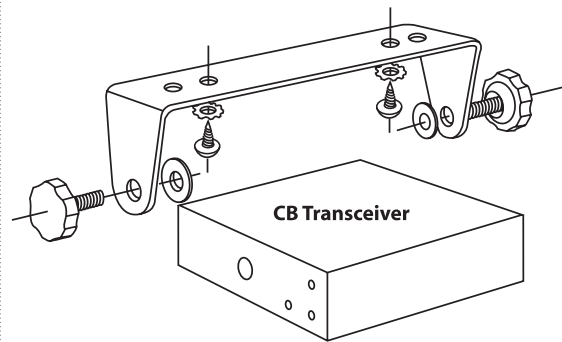

- 2 Drill the holes and secure the bracket.

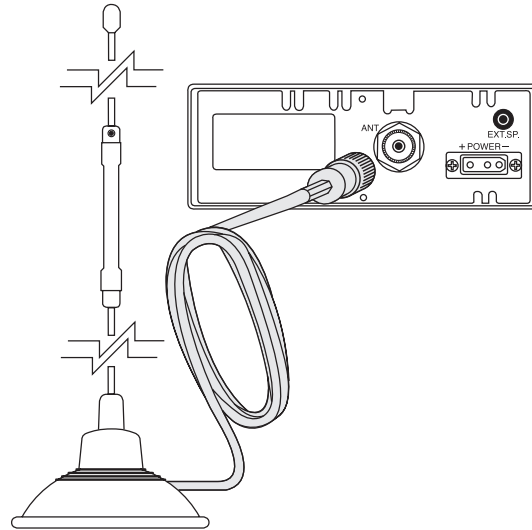

- 3 Connect the antenna cable plug to the receptacle marked "ANT" on the back of the unit.

continued

# Installation

## Note

Before installing the CB radio, visually check the vehicle's battery connection to determine which terminal, positive or negative, is grounded (positive is the larger of the two) to the engine block (or chassis). A negatively grounded vehicle has its negative lead grounded to the chassis.

## Note

Connecting to an accessory fuse prevents the unit from being left on accidentally, and also permits operating the unit without running the engine.

## Note

In positive ground vehicles the red wire goes to the chassis and the black wire is connected to the ignition switch.

## Note

When connected to an accessory fuse, unit will self test the emergency weather alert automatically when ignition is turned on. Turns itself on & off.

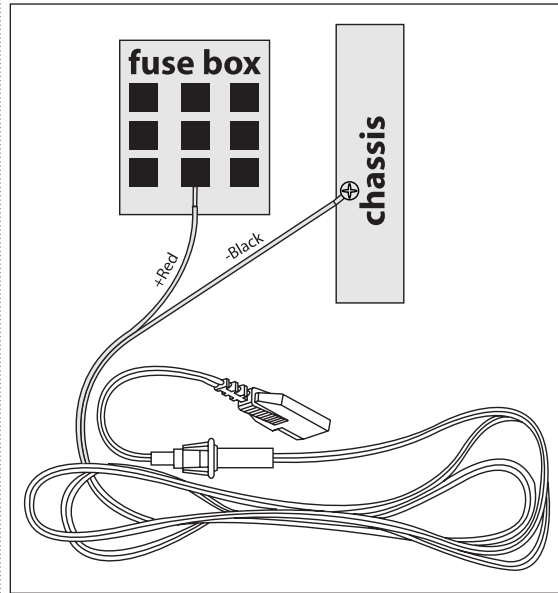

- 4 In a negative grounded vehicle, connect the red lead of the DC power cord to an accessory 12 volt fuse.
- 5 Connect the black lead to the of the DC power cord to the negative post of the battery or to the vehicle chassis.

# Installation

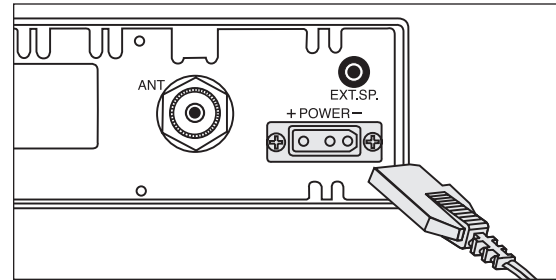

- 6 Plug the power cord into the jack marked "Power" on the back of the unit. Be sure to observe polarity markings.
- 7 Mount the microphone bracket on either side of the unit (driver's left) using two screws supplied. Bracket should be placed under the dash so microphone is readily accessible.

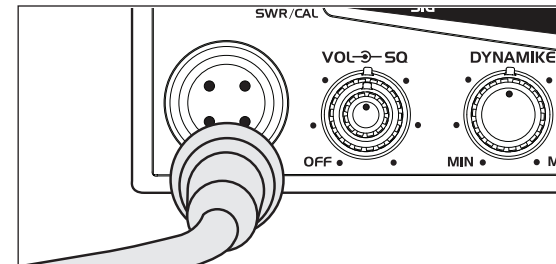
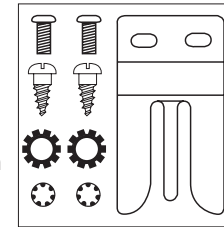

- 8 Attach the 4-pin microphone cable to receptacle on front of unit and install unit in bracket securely.

## Note

If microphone is not connected, audio will not be heard at speaker.

# Antennas

## CB Antenna

### Note

For optimum performance in passenger cars the ideal antenna location is on the center of the roof. Second choice is on the center of the trunk.

### Note

Because many newer trucks feature fiberglass door skins, the outside mirror must be grounded to the chassis via a ground strap, if the antenna is mounted on the mirror bracket.

### Note

3-way Combination Antennas are also available which allow operation of all three bands (AM-FM & CB), using a single antenna. However, this type of antenna usually results in less than normal transmit and receive range when compared to a standard-type "Single Band" CB antenna.

## CB Antenna

Since the maximum allowable power output of the transmitter is limited by the FCC, the antenna is critical in affecting transmission distance. Only a properly matched antenna system will allow maximum power output. Cobra loaded type antenna models are highly recommended for most installations. **For models with Weather Feature (WX), a Dual Band (Center Load/Base Load) antenna is recommended.** Consult your Cobra dealer for further details, or visit our website: [www.cobra.com](http://www.cobra.com)

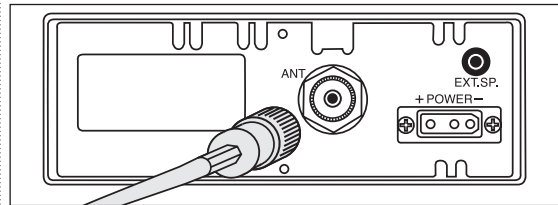

- ① A standard antenna connector is provided on the transceiver for easy connection.

## Marine Installation

The transceiver will not operate at maximum efficiency in a boat without a ground plate, (unless it has a steel hull). Before attempting installation, consult your dealer for information regarding an adequate grounding system and prevention of electrolysis between fittings in the hull and water.

# Ignition Noise Interference

Use of a mobile receiver at low signal levels is normally limited by the presence of electrical noise. The primary source of noise in automobiles is from the alternator and ignition system. Typically, when signal level is adequate, the background noise does not present a serious problem. Also, when extremely low level signals are being received, the transceiver may be operated with the vehicle's engine turned off. The unit requires very little current and therefore will not significantly discharge the vehicle's battery.

Even though the Cobra 29 LX OEM B has an automatic noise limiter, in some installations ignition interference may be high enough to make good communications impossible. Many possibilities exist and variations between vehicles require different solutions. Consult your Cobra dealer or a 2-way radio technician for help in locating the source of a severe noise.



# Operation

## Turning On

### Turning On

Make sure the power cord, antenna and microphone are connected to their proper connectors before starting.

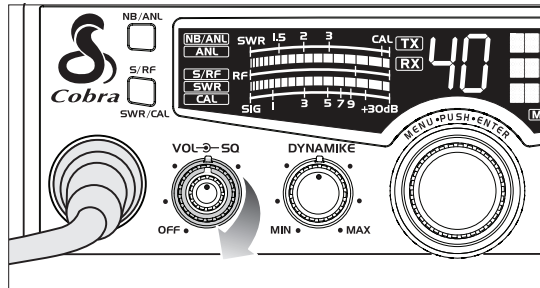

- 1 Rotate the **On/Off Volume** knob *clockwise* to turn unit on and adjust to a normal listening level.

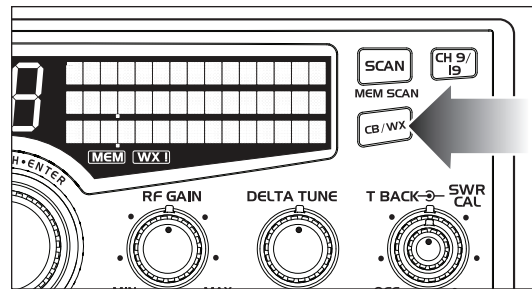

- 2 Press the **CB/WX** button to change modes.

# Operation

## Setting Channel Selector

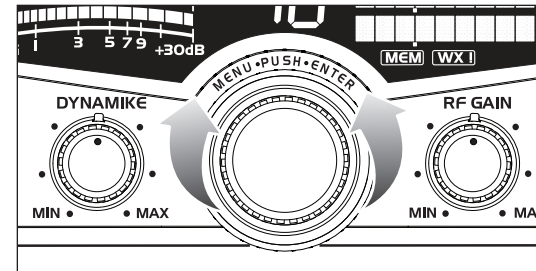

- 3 Select one of forty channels and adjust volume. The selected channel (1 through 40) will be indicated by the readout directly above the channel selector knob

## Setting Channel Selector

### Note

Press **CB/WX** to select **CB**, weather channels mode.

## Calibrate For SWR (Standing Wave Ratio)

**Calibrate for SWR (Standing Wave Ratio)**  
SWR meter calibration is required to accurately measure the SWR of the connected antenna system. Careful adjustment is critical to obtain best accuracy.

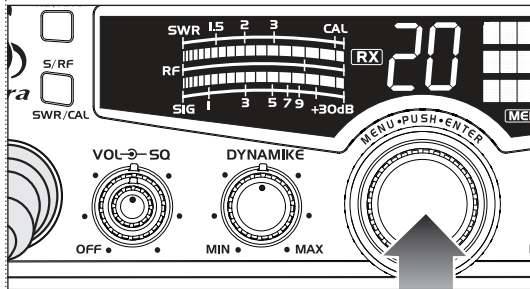

1 Select channel 20.

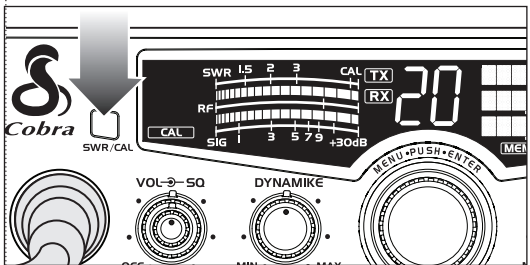

2 Press **SWR/CAL** button to select CAL.

**PUSH & HOLD**

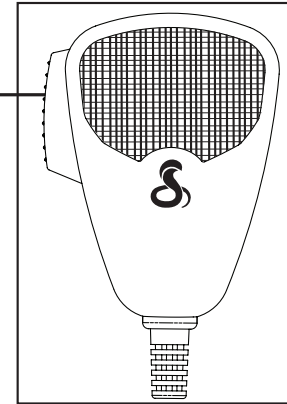

3 Push and hold mic button.

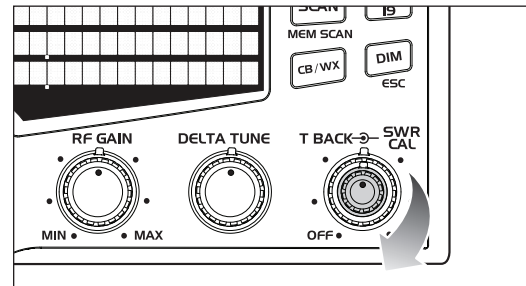

4 While *holding* mic button *adjust* the **SWR CAL** knob so the meter swings to the CAL mark on the meter (located on the right).

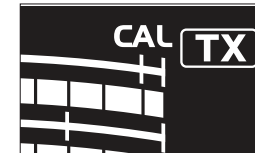

### Note

Calibration must be made in an open area (never in a garage). Vehicle doors must be closed. No one should be standing near the antenna. (See your antenna directions for more complete information).

### Note

The reading will be slightly higher on Channels 1 and 40 compared to Channel 20.

continued

## Calibrate for SWR *continued*

### Note

When switched to SWR mode the meter reading should ideally be as far to the left as possible. Anything over 3 is not acceptable. A slight antenna height adjustment (higher or lower) may be required. Repeat recalibration steps.

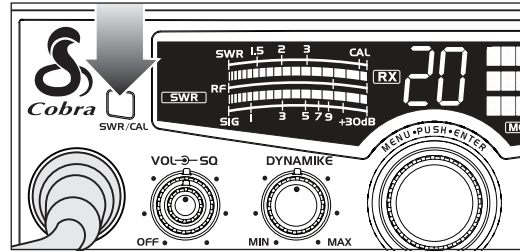

- Release the PTT button, press and release the **S/RF-SWR CAL** button to the SWR position. Then press the PTT button to read the SWR reading.
- Repeat the same steps two through five on Channel 1 and 40. This will check SWR for all channels.

## To Receive

### To Receive

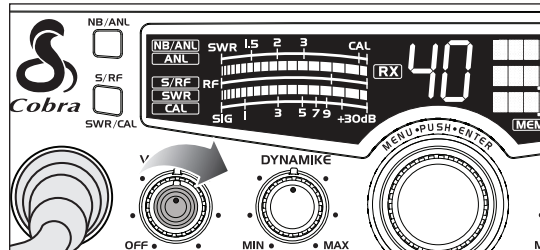

- Rotate the **On/Off Volume** knob *clockwise*. The RX icon will be displayed.

## Selecting A Channel

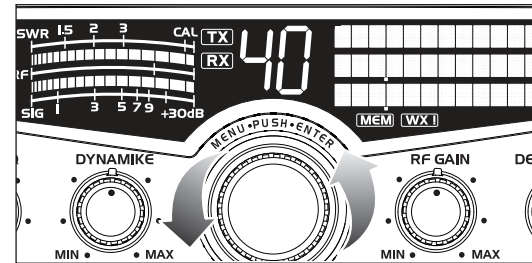

- Unit should be in CB mode. Rotate **channel selector** *clockwise* or *counter-clockwise* to select desired channel.

## S-Meter

Swings proportionately to strength of incoming signal when receiving.

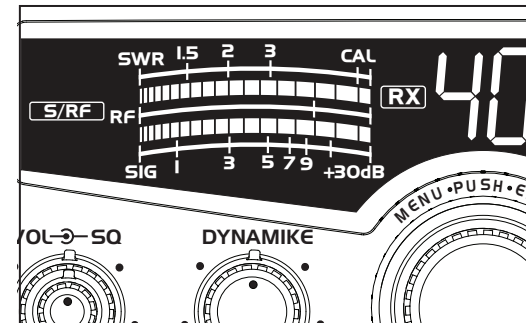

- The **S/RF-SWR-CAL** switch must be in the S/RF setting to read the meter.

## Selecting A Channel

## S-Meter

## To Transmit



### Caution!

Be sure the antenna is properly connected to the radio before transmitting. Prolonged transmitting without an antenna, or a poorly matched antenna, could cause damage to the transmitter.

Be sure to read the F.C.C. Rules and Regulations included with this unit before transmitting.

## To Transmit

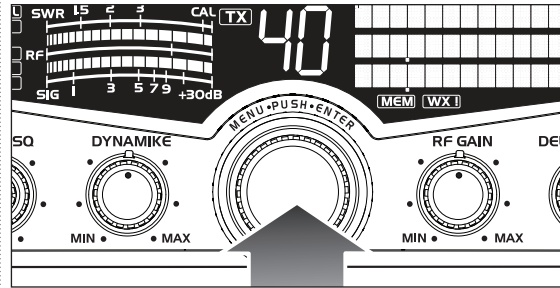

- 1 Select desired channel.

## Transmit

**PUSH & HOLD**

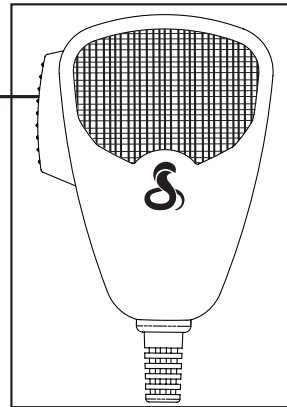

- 2 Push and hold mic button to transmit. Transmitter is now activated. When transmitting, hold the microphone two inches from your mouth and speak in a clear, normal voice. Release to receive.

## Setting Dynamike®

This controls the microphone sensitivity (outgoing audio level).

## Setting Dynamike®

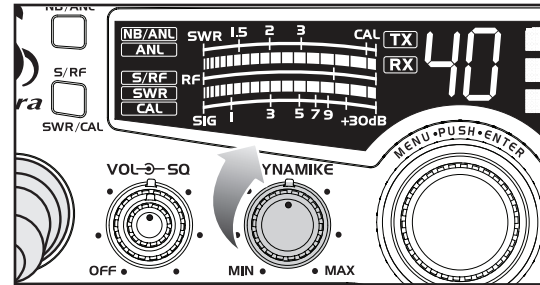

- 3 Initially, set fully *clockwise* so that maximum voice volume is available. Dynamike may have to be reduced in some conditions.

# Operation

## Menu Mode

**Note**  
Use Dim/Escape button to exit from any routine back to CB standby mode.

### Menu Mode

Used to program special features. **Menu/Enter** knob is used to move cursor to desired feature to program.

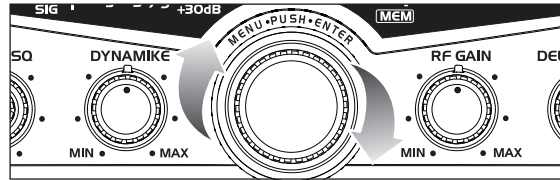

Rotate **Menu/Enter** knob *clockwise* to navigate menu levels.

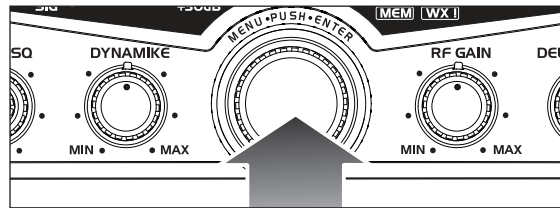

Press **Menu/Enter** knob to select feature to be programmed.

Level 1:

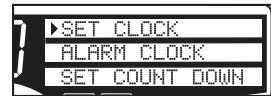

Level 2:

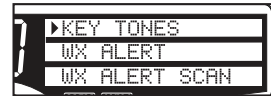

Level 3:

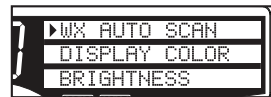

Level 4:

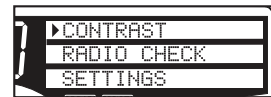

Level 5:

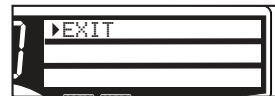

# Operation

## Setting the Clock

**Note**

Normal display will appear if clock has not yet been set.

**Note**

Use Dim/Escape button to exit from any routine back to CB standby mode.

**Note**

The clock should be connected to constant 12V to run continuously.

### Setting the Clock

Using the clock, alarm and countdown functions. To set the clock, press **Menu/Enter** knob and select **Set Clock**.

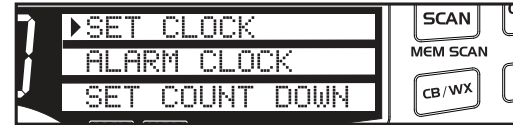

**12:00 PM** will appear in the display and the hours will flash. Rotate **Menu/Enter** knob *clockwise* to select desired hour and press to set.

The minutes will then flash. Rotate **Menu/Enter** knob again to select desired minutes and press to set.

Once the minutes are set, AM or PM will then flash. Rotate **Menu/Enter** knob again to select **AM** or **PM** and press to set or scroll down to **EXIT** and press to return to main menu.

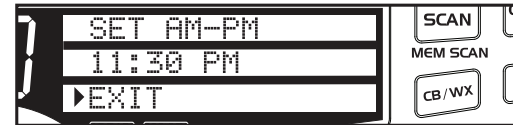

### Setting the Alarm

Your 29 LX OEM B can be utilized as an alarm clock. To set the alarm, press **Menu/Enter** knob and select **Set Alarm**.

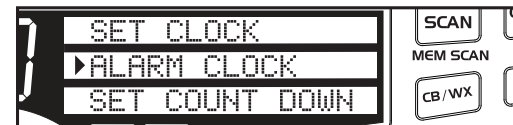

Rotate **Menu/Enter** knob *clockwise* to select **Set Alarm Time**. Follow instructions above for setting the alarm time and AM or PM.

## Setting the Alarm

# Operation

## Setting the Alarm *continued*

### Note

Default snooze time length is 10 minutes.

### Note

Press Dim/Escape button to return to CB standby mode.

### Note

Default alarm length is 60 seconds and is set in 10 second increments.

Once alarm settings are complete, rotate **Menu/Enter** knob *clockwise* to **Set Snooze** and press to select.



Enter desired snooze time (from 1 to 60 minutes). Select **Enter** to exit, return to Set Snooze or Alarm Length. Select Alarm Length to set alarm duration (from 10 to 300 seconds). Pressing **Menu/Enter** knob returns unit to exit, Set Snooze or Alarm Length.

## Setting the Count Down Timer

To set the count down timer, press **Menu/Enter** knob and select **Set Count Down**.



Follow instructions in **Setting the Clock** section (page 17) to set count down hour and minutes. Once desired count down time is selected, press **Menu/Enter** knob again to set and return to the standby menu.

## Key Tones Mode

### Note

Press Dim/Escape button to return to CB mode.

## Key Tones Mode On and Off

Press **Menu/Enter** knob and rotate *clockwise* to **Set Key Tones**. Press **Menu/Enter** to set Key Tones **On/Off**.

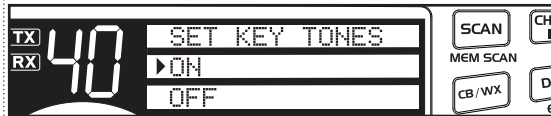

Press **Menu/Enter** knob to select **On/Off** and exit to main menu.

# Operation

## Radio Check Mode

### Note

Press Dim/Escape button to return to CB standby mode. If 10 seconds pass or if Enter button pressed, unit goes to 2nd test.

## Radio Check Mode

Allows testing of important radio functions.

**Test 1- Battery Level:** Confirms that battery voltage level is between 10.8 V to 15.8 V. If in that range, it is "PASS". Outside of that range, either FAIL LOW" or "FAIL HIGH" will be displayed. Press **Menu/Enter** knob to advance to next test.

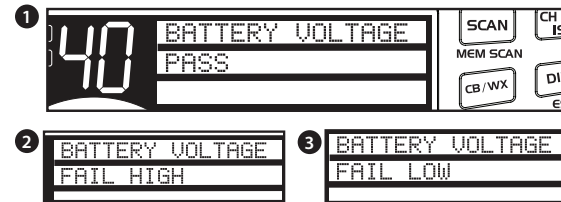

**Test 2- RF Power Output:** Confirms 3.3 to 4 Watt output level. Once Push-to-Talk button is pressed, Pass or Fail will be displayed if level is outside limits.

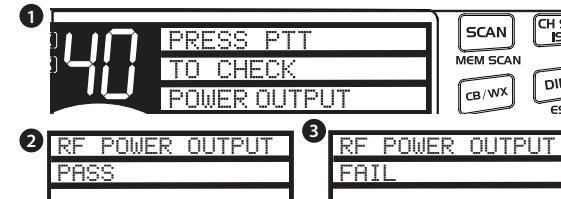

**Test 3- Antenna Mismatch Warning:** Press **Push-to-Talk** button to check antenna/radio for proper matching.

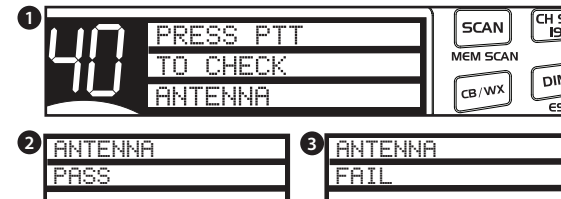

### Note

Press Push-To-Talk within 10 seconds or unit will go to the next test.

### Note

Press Dim/Escape button to return to CB standby mode. If 10 seconds pass or if Enter button pressed, go to 3rd test.

### Note

Press Dim/Escape button to return to CB standby mode. If 10 seconds pass or if Enter button pressed, testing is complete. Unit will return to CB Standby mode.



# Operation

## Setting Display Color Mode

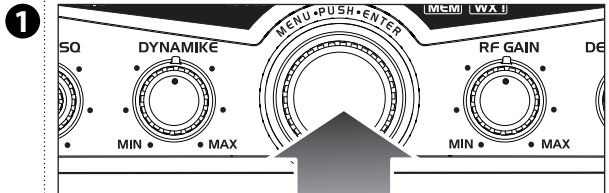

### Setting Display Color Mode

Press **Menu/Enter** knob and scroll down to select **Display Color**.

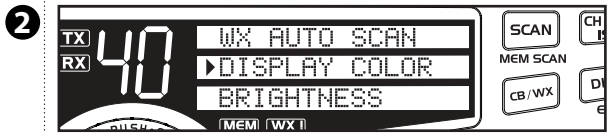

Press and release **Menu/Enter** to set the color.

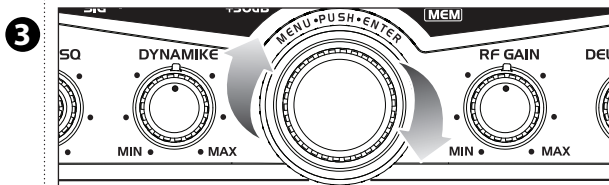

Rotating **Menu/Enter** knob *clockwise* changes the display color from green to blue to amber to red then back to green.



Press **Menu/Enter** knob or escape button again to exit routine.

**Note**  
Select **EXIT** to return to main menu. Press **Dim/Escape** button to return to **CB** mode.

# Operation

## Setting Brightness Mode

Press **Menu/Enter** knob to select **Set Brightness**



Rotate **Menu/Enter** knob *clockwise* to **Select Brightness**. Press **Menu/Enter** knob to select **Day-Bright**. Turn **Menu/Enter** *clockwise* to increase brightness and turn *counter-clockwise* to decrease brightness.



To set the day bright level, turn the **Menu/Enter** knob *clockwise* to a desired setting and then press **Menu/Enter**. To set the **Night-Dim** level, repeat instructions above then select **Night-Dim**.

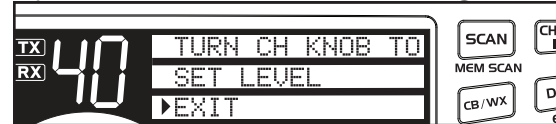

Press **Menu/Enter** knob again to exit routine.

## Setting Contrast Mode

Press **Menu/Enter** knob and rotate *clockwise* to select **Set Contrast**. Press **Menu/Enter** knob again and rotate *clockwise* to increase contrast, *counter-clockwise* to decrease contrast. Press **Menu/Enter** knob to set contrast.



Press **Menu/Enter** knob again to exit routine.

## Setting Brightness Mode

**Note**  
If an attempt is made to exceed the highest or lowest brightness levels, 1 error beep will be heard.

**Note**  
Exit will return to menu mode. **ESC** will exit and return to **CB Standby**.

**Note**  
To select day or night levels, press and release **Dim/Escape** button once levels are set.

**Note**  
To toggle from day to night settings, see page 28.

## Setting Contrast Mode

**Note**  
If an attempt is made to exceed the highest or lowest contrast levels, 1 error beep will be heard.

## Weather Information

### Note

To see a full listing of NOAA Weather Radio stations and locations, please visit: [weather.gov/nwr/station\\_listing](http://weather.gov/nwr/station_listing)

For ideal weather reception use a dual band antenna (center load/baseload).

## Weather Alert

### What You Should Know About Weather

If threatening weather is nearby, the National Weather Service may broadcast a 10 second alert tone. This tone will be heard through the CB, even if the CB/WX Control is in the CB mode or the unit is turned off.

This enables you to monitor CB frequencies and still be warned by the National Weather Service Emergency Alert. When you hear the alert, press the **CB/WX** button in the **WX** mode. You will then be able to hear the Weather Warning Broadcast.

Your 29 LX OEM B has a special auto squelch circuit for weather transmission which disables your squelch control.

## Weather Alert Scan

The unit will continually scan all 10 WX channels for 1050 Hz tone. If the tone is detected the unit will activate WX mode on the channel with the tone. Default state is **Off**. Go to Menu mode to choose **On/Off** (see page 24):

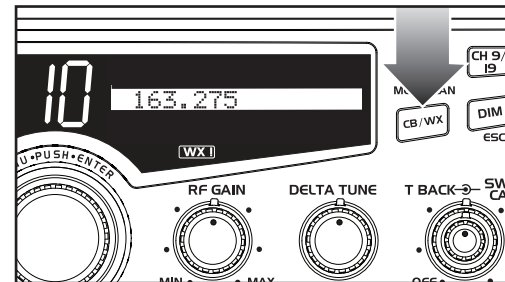

## Weather Auto Scan

If active while in CB mode, will determine if the present WX channel is active. If the present WX channel is not active, will search for the strongest WX channel and auto change to that channel. Default is off. Go to Menu mode to choose on/off (see page 24).

## Weather Channels

### What is Weather Radio?

NOAA Weather Radio (NWR) is a service of the National Oceanic and Atmospheric Administration (NOAA), of the U.S. Department of Commerce. 380 NWR stations are in operation by the U.S. Government in addition to several NWR stations that are maintained by private interest groups. The capability is to supplement warnings by sirens and by commercial radio and television. The 10 National Weather Channels provide full coverage to keep you informed of weather conditions, 24 hours a day, 7 days a week.



# Operation

## Weather Alert Mode

**Note**  
Press Dim/Escape button to return to CB mode.

**Setting Weather Alert Mode**  
Turns WX Alert On/Off. Default is **Off**. Press **Menu/Enter** knob to select **Set WX Alert**. If Weather is **On**, WX Alert Icon will be displayed.



Press **Menu/Enter** knob to select **On/Off** and exit to main menu.

## Setting Weather Alert Scan

**Note**  
If an alert is detected the unit will activate WX mode on the channel with the alert. Use **Menu/Enter** knob to select **On/Off** and press to set.

**Setting Weather Alert Scan**  
Press **Menu/Enter** knob and rotate *clockwise* to **WX Alert Scan**. Press **Menu/Enter** knob to select **On/Off**.



Press **Menu/Enter** knob to select **On/Off** and exit to main menu.

## Setting Weather Auto Scan

**Note**  
Press Dim/Escape button to return to CB mode.

**Setting Weather Auto Scan**  
Press **Menu/Enter** knob and rotate *clockwise* to **WX Auto Scan**. Press **Menu/Enter** knob to select **On/Off**.



Press **Menu/Enter** knob to select **On/Off** and exit to main menu.

# Operation

## Software Version/Factory Settings

**Software Version/Factory Settings**  
Displays current software version and returns unit to original factory settings. To view software version, rotate **Menu/Enter** knob *clockwise* to select **Settings** then **Software Version**.

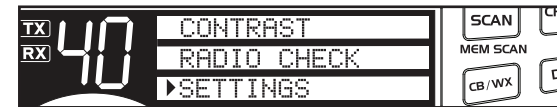

To restore default settings, Press **Menu/Enter** knob again. Rotate **Menu/Enter** knob *clockwise* to select **Settings** then **Go To Default**.



Press **Menu/Enter** knob to restore default settings. Choose **NO** to maintain present setting with no change.

**Note**  
Default display color is green.

# Operation

## NB-ANL/OFF (Noise Blanker/Automatic Noise Limiter) Button

### Note

The RF noise blanker is very effective in reducing repetitive noises such as ignition interference.

NB-ANL/OFF (Noise Blanker/Automatic Noise Limiter) Button

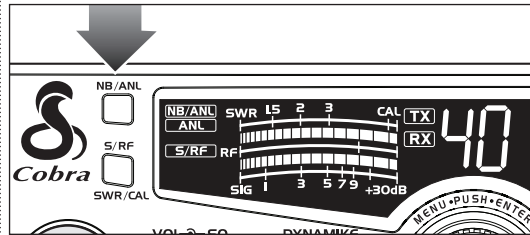

- When switched to ANL the Automatic Noise Limiter is activated. This helps reduce noise created by the vehicle's electronics.  
When switched to NB/ANL mode the RF Noise Blanker is also activated, providing increased noise filtration.  
When switched to OFF mode all noise filtration will be turned off.

## RF Gain Control

### Note

The RF Gain is used to optimize reception in weak signal areas.

RF Gain Control

The RF Gain is used to optimize reception in strong or weak signal areas.

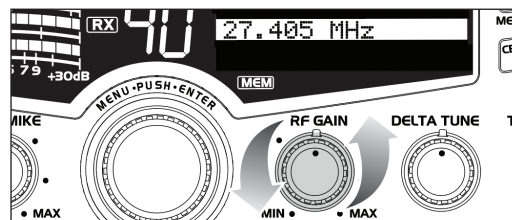

- Rotate the RF Gain knob counterclockwise to reduce gain in strong signal areas. In weak signal areas turn clockwise to increase gain.

# Operation

## Program Memory Channels

Set first channel. Press and hold **Scan/MemScan** button. Memory icon will appear. Select second channel, press and hold **Scan/MemScan** button again until Memory icon appears. Repeat above steps to enter up to 10 channels in memory.

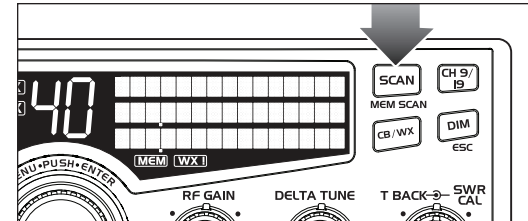
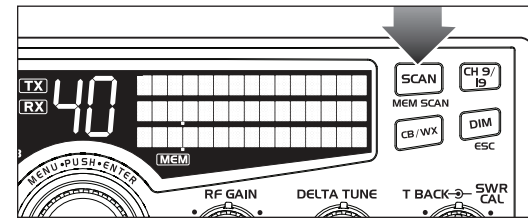

- Pressing the **Scan/Memory Scan** button toggles from **Off** to **Scan All Channels** to **Memory Channel Only Scan** and back to **Off**.

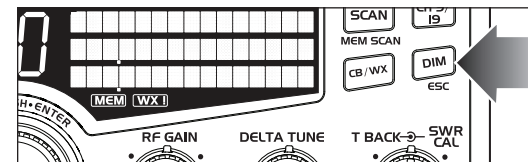

- Press **Dim/Escape** button to end Scan and return to CB mode.

## Program Memory Channels

### Note

The radio should be squelched before scan features are activated.

### Note

Keying the microphone will stop the scan feature.

### Note

If more than 10 channels are attempted to be programmed, 3 error beeps will be heard and "Memory Full" will be displayed for 10 seconds or until any button is pushed.

### Note

To remove a channel from memory, go to the unwanted memory channel then press and hold the scan button until the MEM icon turns off.

### Note

If in WX mode the unit will scan Weather channels.

# Operation

## Scan CB Channels

### Scan CB Channels

To scan all 40 CB channels, the unit must be squelched. Press and release **Scan/Mem Scan** button once.

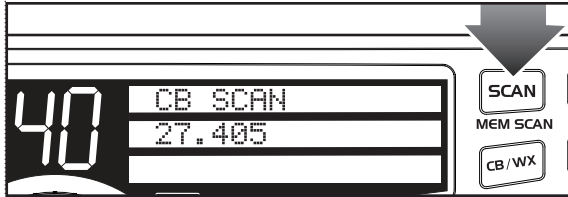

## Scan Memory Channels

### Scan Memory Channels

To scan memory channels, press and release **Scan/Mem Scan** button twice.

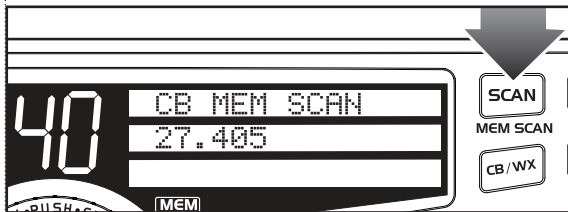

## Dimmer Control

### Dimmer Control

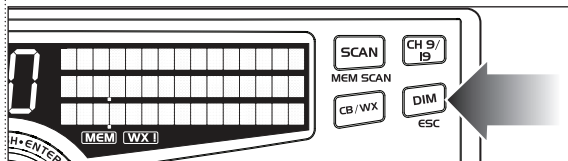

- 1 Press **Dim/Esc** button to toggle between day and night settings. See setting instructions on page 21.

# Operation

## Setting Squelch

Squelch is the “control gate” for incoming signals.

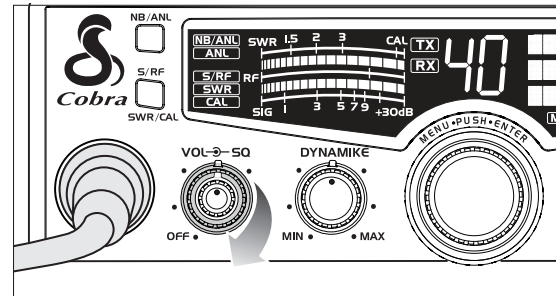

- 1 Full *clockwise* rotation closes the gate allowing only very strong signals to enter.

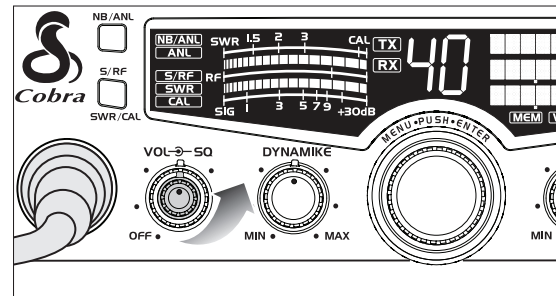

- 2 Full *counterclockwise* rotation opens the “gate” allowing all signals in.

## Setting Squelch

### Gate closed

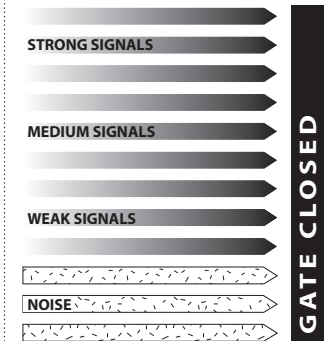

### Gate open

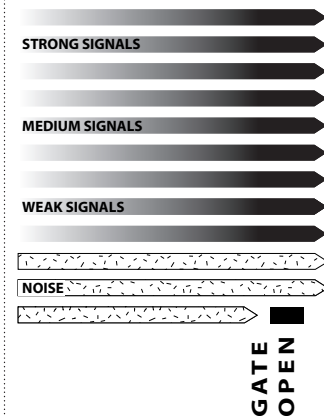

# Operation

## Setting Squelch

Continued

Gate set to Desired Squelch Setting (DSS)

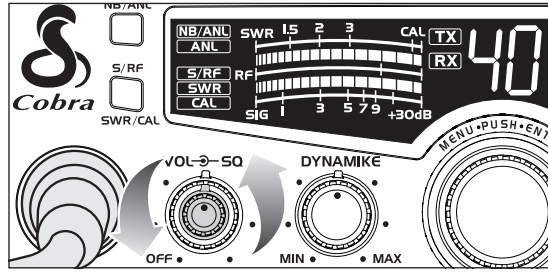
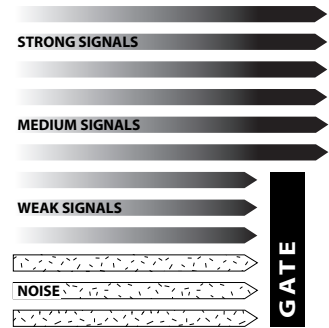

- To achieve the Desired Squelch Setting (DSS), turn the Squelch control *counterclockwise* until you hear noise. Now turn the control *clockwise* just until the noise stops. This is the DSS setting.

## S/R/F Meter

### S/R/F Meter

This meter swings proportionately to the RF output (outgoing signal) while transmitting.

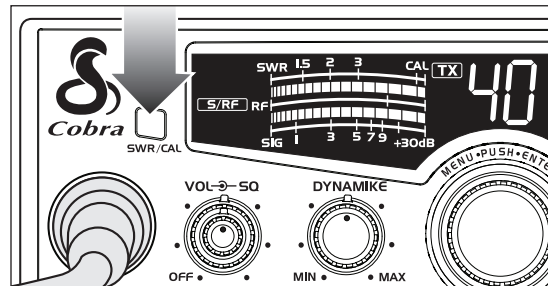

- The **S/R/F-SWR-CAL** button must be in the S/R/F mode.

# Operation

## External Speaker

The external speaker jack is used for remote receiver monitoring.

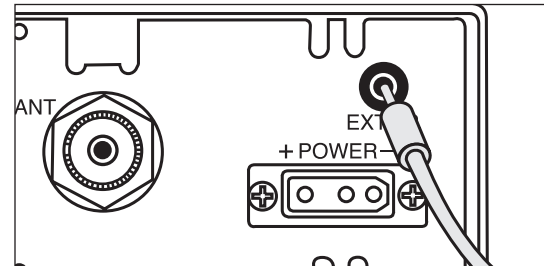

- Connect an external speaker to the external speaker jack on the rear panel.

## External Speaker

### Note

The external speaker should have 8-ohm impedance and be rated to handle at least 4.0 watts. When the external speaker is plugged in, the internal speaker is automatically disconnected. To order external speakers and other accessories, please go to [www.cobra.com](http://www.cobra.com)

### Note

Cobra external speakers are rated at 10 watts.

## Home And Office Set-Up

### Base Station Operation (From 120V AC House Current)



**Warning!**  
Do not attempt to operate this transceiver by connecting it directly to 120V AC.

#### Base Station Operation (From 120V AC House Current)

To operate your transceiver from home or office you will need a 13.2 volt DC Power Supply rated at a minimum of 2 amps, and a properly installed base station antenna.

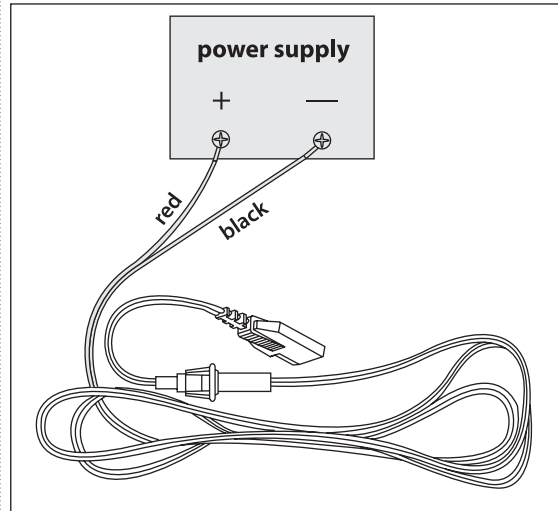

- 1 Simply connect the red (+) and black (-) leads of the transceiver to the corresponding terminals of the power pack.

## Temporary Mobile Set-Up

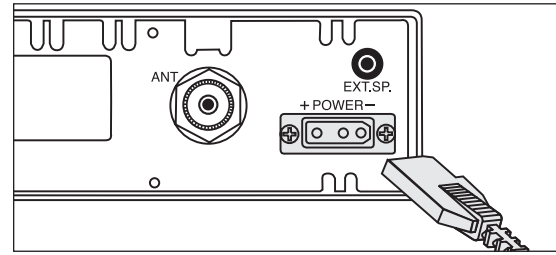

- 2 Plug power cable into back of unit marked "Power". Be sure to observe polarity markings.
- 3 Connect properly installed and matched base station antenna.

#### Temporary Mobile Operation

For temporary mobile operation you may want to purchase an optional cigarette lighter adapter from your COBRA dealer. This adapter and a magnetic mount antenna allow you to quickly "install" your transceiver for temporary use.

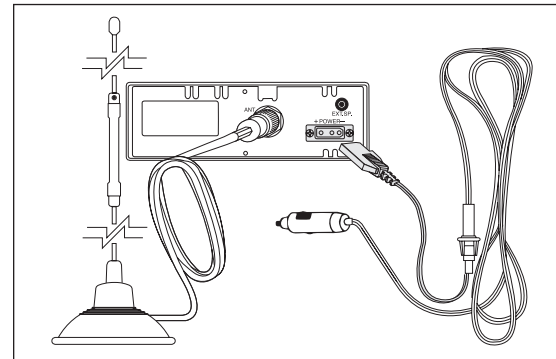

#### Temporary Mobile Set-Up

# How Your CB Can Serve You

## A Few Rules You Should Know

## Channel 9 Emergency Messages

**Note**

If no response on channel 9, try channels 19 or 14.

- Warn of traffic problems
- Provide weather and road data
- Provide help in event of an emergency
- Provide direct contact with home or office
- Assist police by reporting erratic drivers
- Get "local information" to find destination
- Communicate with family and friends
- Suggest spots to eat and sleep
- Keep you alert while traveling

### A Few Rules You Should Know

- A. Conversations cannot last more than 5 minutes with another station. A one minute break is required to let others use the channel.
- B. You cannot blast others off the air by use of illegally amplified transmitters or illegally high antennas.
- C. You cannot use CB to promote illegal activities.
- D. Profanity is not allowed.
- E. You may not transmit music with a CB.
- F. Selling of merchandise and/or services is prohibited.

**1. Set to channel 9 for emergencies**  
Be sure antenna is properly connected.

**2. CB Distress Data**  
When transmitting an emergency, you should request a "REACT BASE" and provide the CB distress data (called **CLIP**):

- |                   |                                      |
|-------------------|--------------------------------------|
| <b>C</b> all Sign | <i>Identify yourself.</i>            |
| <b>L</b> ocation  | <i>Be exact.</i>                     |
| <b>I</b> njuries  | <i>Number. Type. Trapped?</i>        |
| <b>P</b> roblem   | <i>Give details and help needed.</i> |

Transmit **CLIP** repeatedly so any monitor can assist.

# How Your CB Can Serve You

The FCC gives these examples of permitted and prohibited messages for channel 9. These are only guidelines and not all-inclusive:

Permitted	Example Message
Yes	"Tornado sighted six miles north of town."
No	"Post number 10. No tornado sighted."
Yes	"Out of gas on I-95 at mile marker 211."
No	"Out of gas in my driveway."
Yes	"Four car accident on I-94 at Exit 11. Send police and ambulance."
No	"Traffic moving smoothly on I-94."
Yes	"Weather Bureau has issued thunderstorm warning. Bring sailboat into port."
No	"Attention motorists. Weather Bureau advises snow tomorrow will accumulate 4 to 6 inches."
Yes	"Fire in building at 539 Main, Evanston."
No	"Halloween patrol number 3. All quiet."

# How Your CB Can Serve You

## CB 10-Codes

Citizen Bands have adopted the "10-CODES" for standard questions and answers. These codes provide quick and easy communication, especially in noisy areas. Following are some of the more common codes and meanings:

### Code Meaning

10-1	Receiving poorly
10-2	Receiving well
10-3	Stop transmitting
10-4	OK, message received
10-5	Relay message
10-6	Busy, stand by
10-7	Out of service, leaving
10-8	In service, subject to call
10-9	Repeat message
10-10	Transmission completed standing by
10-11	Talking too rapidly
10-12	Visitors present
10-13	Advise weather/roads
10-16	Make pick up at
10-17	Urgent business
10-18	Anything for us?
10-19	Return to base
10-20	My location is
10-21	Call by phone
10-22	Report in person to
10-23	Stand by
10-24	Completed last assignment
10-25	Can you contact
10-26	Disregard last info
10-27	Moving to channel
10-28	Identify your station

### Code Meaning

10-29	Time is up for contact
10-30	Does not conform to FCC rules
10-33	Emergency traffic
10-34	Trouble at this station
10-35	Confidential information
10-36	Correct time is
10-37	Wrecker needed at
10-38	Ambulance needed
10-39	Message delivered
10-41	Turn to channel
10-42	Traffic accident at
10-43	Traffic tie up at
10-44	Have a message for
10-45	All units within range please report
10-50	Break channel
10-60	What is next message number?
10-62	Unable to copy. Use phone
10-63	Net directed to
10-64	Net clear
10-65	Awaiting your next message/assignment
10-67	All units comply
10-70	Fire at
10-71	Proceed, transmission in sequence
10-77	Negative contact
10-81	Reserve hotel room for
10-82	Reserve room for
10-85	My address is
10-91	Talk closer to mic
10-93	Check my frequency on this channel
10-94	Give me a long count
10-99	Mission completed, all units secure
10-200	Police needed at



# Frequency Ranges

# 29 LX OEM B Specifications

The Cobra 29 LX OEM B transceiver represents one of the most advanced AM two-way radios used as a Class D station in the Citizens Radio Service. This unit features advanced Phase Lock Loop (PLL) circuitry providing complete coverage of all 40 CB channels.

CB Channel	Channel Freq. In MHz	CB Channel	Channel Freq. In MHz	WX Channel	Freq. In MHz
1	26.965	21	27.215	1	162.550
2	26.975	22	27.225	2	162.400
3	26.985	23	27.255	3	162.475
4	27.005	24	27.235	4	162.425
5	27.015	25	27.245	5	162.450
6	27.025	26	27.265	6	162.500
7	27.035	27	27.275	7	162.525
8	27.055	28	27.285	8	161.650
9	27.065	29	27.295	9	161.775
10	27.075	30	27.305	10	163.275
11	27.085	31	27.315		
12	27.105	32	27.325		
13	27.115	33	27.335		
14	27.125	34	27.345		
15	27.135	35	27.355		
16	27.155	36	27.365		
17	27.165	37	27.375		
18	27.175	38	27.385		
19	27.185	39	27.395		
20	27.205	40	27.405		

GENERAL	
CHANNELS	CB - 40 CH
FREQUENCY RANGE	CB - 26.965 TO 27.405 MHZ WX - 162.400 TO 162.775 MHZ
FREQUENCY TOLERANCE	0.005 %
FREQUENCY CONTROL	PLL (PHASE LOCK LOOP) SYNTHESIZER
OPERATING TEMPERATURE RANGE	-30° C TO + 50° C
MICROPHONE	Plug-in dynamic
INPUT VOLTAGE	13.2VDC nom. (positive or negative ground)
Current Drain	Transmit: AM full mod., 1.5A (maximum) Receive: Squelched, 0.3A; full audio output, 1.2A (nominal)
Size	8-5/8" D x 7-9/32" W x 2-13/63" H
Weight	4 lbs.
Antenna Connector	UHF; SO-239
Meter	Indicates relative power output received signal strength, and vswr

TRANSMITTER	
Power Output	4 watts
Modulation	AM (Amplitude Modulation)
Frequency Response	300 to 3000 Hz
Output Impedance	50 ohms, unbalanced

RECEIVER	
Sensitivity	Less than 1 μV for 10 dB (S+N)/N
Selectivity	6 dB @ 7 KHz, 60 dB @ 10KHz
Image Rejection	80 dB, typical
Adjacent-Channel Rejection	60 dB, typical
IF Frequencies	Double Conversion: 1st: 10.695 MHz 2nd: 455 KHz
Automatic Gain Control (AGC)	Less than 10 dB change in audio output for inputs from 10 to 50,000 microvolts
RF Gain range	40 db
Noise Blanker	RF type
Squelch	Adjustable; threshold less than 1μV
Audio Output Power	4 watts
Frequency Response	300 to 3000 Hz
Distortion	Less than 7% @3 watts @ 1000 Hz
Built-in Speaker	8 ohms, 5w
External Speaker (Not supplied)	8 ohms; disables internal speaker when connected

(SPECIFICATIONS SUBJECT TO CHANGE WITHOUT NOTICE)



# FCC Statement

## FCC Part 15.19 Warning Statement

THIS DEVICE COMPLIES WITH PART 15 OF THE FCC RULES. OPERATION IS SUBJECT TO THE FOLLOWING TWO CONDITIONS: (1) THIS DEVICE MAY NOT CAUSE HARMFUL INTERFERENCE, AND (2) THIS DEVICE MUST ACCEPT ANY INTERFERENCE RECEIVED, INCLUDING INTERFERENCE THAT MAY CAUSE UNDESIRE OPERATION.

## FCC Part 15.21 Warning Statement-

**NOTE:** THE GRANTEE IS NOT RESPONSIBLE FOR ANY CHANGES OR MODIFICATIONS NOT EXPRESSLY APPROVED BY THE PARTY RESPONSIBLE FOR COMPLIANCE. SUCH MODIFICATIONS COULD VOID THE USER'S AUTHORITY TO OPERATE THE EQUIPMENT.

## FCC Part 15.105(b) Warning Statement

**NOTE:** This equipment has been tested and found to comply with the limits for a Class B digital device, pursuant to part 15 of the FCC Rules. These limits are designed to provide reasonable protection against harmful interference in a residential installation. This equipment generates uses and can radiate radio frequency energy and, if not installed and used in accordance with the instructions, may cause harmful interference to radio communications. However, there is no guarantee that interference will not occur in a particular installation. If this equipment does cause harmful interference to radio or television reception, which can be determined by turning the equipment off and on, the user is encouraged to try to correct the interference by one or more of the following measures:

- Reorient or relocate the receiving antenna.
- Increase the separation between the equipment and receiver.
- Connect the equipment into an outlet on a circuit different from that to which the receiver is connected.
- Consult the dealer or an experienced radio/TV technician for help.

## IC RSS-GEN, Sec 8.4 Warning Statement

**ENGLISH:** This device complies with Industry Canada license-exempt RSS standard(s). Operation is subject to the following two conditions: (1) this device may not cause interference, and (2) this device must accept any interference, including interference that may cause undesired operation of the device.

**FRENCH:** Le présent appareil est conforme aux CNR d'Industrie Canada applicables aux appareils radio exempts de licence. L'exploitation est autorisée aux deux conditions suivantes : (1) l'appareil ne doit pas produire de brouillage, et (2) l'utilisateur de l'appareil doit accepter tout brouillage radioélectrique subi, même si le brouillage est susceptible d'en compromettre le fonctionnement.

## IC RSS-GEN, Sec 8.3 Warning Statement

**ENGLISH:** This radio transmitter (identify the device by certification number, or model number if Category II) has been approved by Industry Canada to operate with the antenna types listed below with the maximum permissible gain and required antenna impedance for each antenna type indicated. Antenna types not included in this list, having a gain greater than the maximum gain indicated for that type, are strictly prohibited for use with this device.

Immediately following the above notice, the manufacturer shall provide a list of all antenna types approved for use with the transmitter, indicating the maximum permissible antenna gain (in dBi) and required impedance for each.

**FRENCH:** Le présent émetteur radio (identifier le dispositif par son numéro de certification ou son numéro de modèle s'il fait partie du matériel de catégorie I) a été approuvé par Industrie Canada pour fonctionner avec les types d'antenne énumérés ci-dessous et ayant un gain admissible maximal et l'impédance requise pour chaque type d'antenne. Les types d'antenne non inclus dans cette liste, ou dont le gain est supérieur au gain maximal indiqué, sont strictement interdits pour l'exploitation de l'émetteur.

# Limited Two Year Warranty

## Warranty Terms:

Cobra warrants your product against all defects in materials and workmanship for a period of two (2) years from the date of original purchase.

Cobra, at our sole discretion, will repair or replace your product (with the same or comparable product) free of charge.

Cobra will not pay shipping charges that you incur for sending your product to us. Products received COD will be refused.

To make a warranty claim, we will require proof or purchase in the form of an invoice or receipt. No proof of purchase is required for factory direct purchases.

**Warranty Exclusions:** Warranty does not apply to your product under any of the following conditions: 1. The serial number has been removed or modified. 2. Your product has been subjected to misuse or damage (including water damage, physical abuse, and/or improper installation). 3. Your product has been modified in any way. 4. Your receipt or proof-of-purchase is from a non-authorized dealer or internet auction site including E-bay, U-bid, or other non-authorized resellers.

**LIMITATION OF WARRANTY: EXCEPT AS EXPRESSLY PROVIDED HEREIN, YOU ARE ACQUIRING THE PRODUCT "AS IS" AND "WHERE IS", WITHOUT REPRESENTATION OR WARRANTY. COBRA SPECIFICALLY DISCLAIMS ANY REPRESENTATION OR WARRANTY INCLUDING, BUT NOT LIMITED TO THOSE CONCERNING THE MERCHANTABILITY AND SUITABILITY OF THE PRODUCT FOR A PARTICULAR PURPOSE. COBRA SHALL NOT BE LIABLE FOR CONSEQUENTIAL, SPECIAL OR INCIDENTAL DAMAGES INCLUDING, WITHOUT LIMITATION, DAMAGES ARISING OUT OF THE USE, MISUSE OR MOUNTING OF THE PRODUCT.**

The above limitations or exclusions shall be limited to the extent they violate the laws of any particular state. Cobra is not responsible for products lost in shipment between the owner and our service center.

## General Warranty Information

Each product we manufacture is covered by our factory warranty. While each product may have unique components and policy, the general guideline below will apply to most Cobra products.

All Cobra products purchased factory-direct or from our Authorized Resellers will come with a full one to three (1-3) year warranty from the date of the original retail purchase (see policy statement above for full warranty details and exclusions).

Standard accessories packaged with each model will have a one-year factory warranty.

Accessory items have a one-year factory warranty.

Shipping to our facility is not covered in our warranty. Return shipping is included within the US.

This warranty is non-transferrable.

For the sake of clarity, 'repair or replace the Product or its defective part' does not include removal or installation work, costs or expenses which include but are not limited to labor costs or expenses.

Cobra will not be responsible for lost packages.

# Product Service

If you have any questions about operation or installing your new Cobra product, PLEASE CONTACT COBRA FIRST...do not return this product to any retail store. The contact information for Cobra will vary depending on the country in which you purchased and utilize the product. For the latest contact information, please go to [www.cobra.com/support](http://www.cobra.com/support)

For products purchased in the U.S.A. you may call 800-543-1608.

For products purchased in the U.S.A., if your product should require factory service, please please go to [www.cobra.com/support](http://www.cobra.com/support) and follow the instructions for returning your product to the Cobra Factory Service Department for service. Should there be any problems with this product or further information is needed on its features please visit [www.cobra.com](http://www.cobra.com) for support, frequently asked questions, Declarations of Conformity, and full manuals.

## For Products Purchased Outside the U.S.A. or Canada

Please contact your local dealer for product service information.

## For Products Used in Canada

### Industry Canada Notice

This device complies with Industry Canada license-exempt RSS standard(s). Operation is subject to the following two conditions:

- (1) this device may not cause interference, and
- (2) this device must accept any interference, including interference that may cause undesired operation of the device.

Le présent appareil est conforme aux CNR d'Industrie Canada applicables aux appareils radio exempts de licence. L'exploitation est autorisée aux deux conditions suivantes:

- (1) l'appareil ne doit pas produire de brouillage, et
- (2) l'utilisateur de l'appareil doit accepter tout brouillage radioélectrique subi, même si le brouillage est susceptible d'en compromettre le fonctionnement.



# 29 LX OEM B

## Professional CB Radio

### Advanced Communications Features



OWNER'S MANUAL

For more information or to order any of our products, please visit our website: [www.cobra.com](http://www.cobra.com)

©2021 Cobra Electronics Corporation

Cobra®, Dynamike®, Nothing Comes Close to a Cobra® and the snake design are registered trademarks of Cobra Electronics Corporation, USA.

Cobra Electronics Corporation™ is a trademark of Cobra Electronics Corporation, USA.

Pat. [www.cobra.com/patents](http://www.cobra.com/patents)

Nothing Comes Close to a Cobra®

## The CB Story

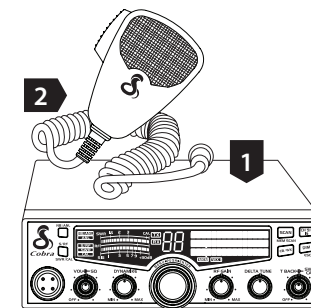

The Citizens Band lies between the shortwave broadcast and 10-meter Amateur radio bands, and was established by law in 1949. The Class D two-way communications service was opened in 1959. (CB also includes a Class A citizens band and Class C remote control frequencies.)

### Federal Communications FCC Regulations

FCC regulations permit only "transmissions" (one party to another) rather than "broadcasts" (to a wide audience). Thus, advertising is not allowed on CB Channels because that is "broadcasting."

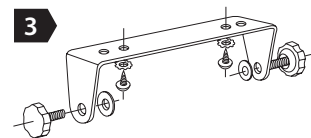

### FCC Warnings

All transmitter adjustments other than those supplied by the manufacturer as front panel operating controls, must be made by, or under the supervision of, the holder of an FCC-issued general Radio-Telephone Operator's License.

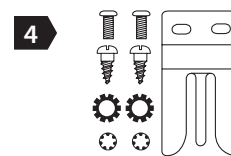

Replacement or substitution of transistors, regular diodes or other parts of a unique nature, with parts other than those recommended by Cobra, may cause violation of the technical regulations of Part 95 of the FCC Rules, or violation of Type Acceptance requirements of Part 2 of the Rules.

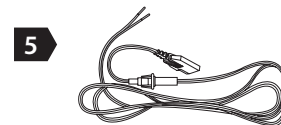

### What's Included with Your 29 LX OEM B



- 1 CB Transceiver
- 2 Microphone
- 3 Transceiver Bracket
- 4 Microphone Bracket
- 5 DC Power Cord
- 6 Operating Manual



## Controls and Indicators

### Front Side

1. 4-Pin Microphone Connector
2. Power On/Off, Volume
3. Squelch
4. Dynamike
5. Menu/Enter/Channel Selector
6. RF Gain
7. Delta Tune
8. Talk Back Control
9. SWR Calibration
10. Dim/Escapes Button
11. Channel 9/Channel 19 Button
12. Scan/Memory Scan
13. CB/WX Weather Button
14. LCD Display
15. RX (Receive)/TX (Transmit), Indicators
16. Signal Strength Meter
17. NB/ANL Button
18. S/R/SWR CAL Button
19. Microphone

### Back Side

20. External Speaker Jack
21. Antenna Connector
22. Power Jack

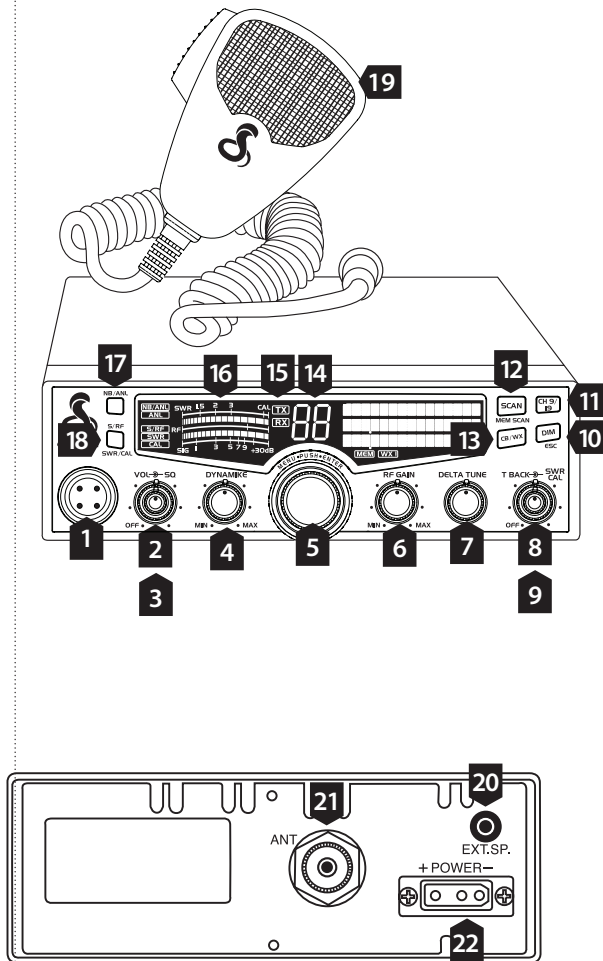

## Our Thanks to You

Thank you for purchasing the Cobra 29 LX OEM B CB Radio. Properly used, this Cobra product will give you many years of reliable service.

### Customer Support

Should you encounter any problems with the product or not understand its many features, please refer to this owner's manual. If, after referring to the manual, you still need help, call Cobra Customer Service at 800-543-1608.

### Cobra Assistance

Should you encounter any problems with this product, or not understand its many features, please refer to this owner's manual. If you require further assistance after reading this manual, Cobra Electronics offers the following customer assistance services:

**Monday-Friday 9:00 AM-5:00 PM EST**

Call: 800-543-1608

### SERVICE

**Monday-Thursday**  
9:00AM-5:00PM EST  
Call: 800-543-1608

### Office:

6500 West Cortland Street,  
Chicago, IL, 60707

**Have questions? We can help.**

**Contact us at 800-543-1608**  
**M-F 9:00AM-5PM EST**

**For Assistance Outside the U.S.A.**

Contact Your Local Dealer

## Ordering Info

You can find quality Cobra products and accessories at your local Cobra dealer, or in the U.S.A., you can order directly from Cobra.

Please visit [www.cobra.com](http://www.cobra.com)

Web orders will normally ship the next business day if received by us before 2:00 PM Eastern Time. Orders do not ship on weekends or holidays. All standard deliveries are Monday-Friday only. Saturday delivery can be requested in certain areas of the country for an additional shipping fee by calling Sales at 800-543-1608.

Certain orders may require additional days to process prior to shipping. Holidays may also impact processing and shipping time frame. Occasionally, items may not ship due to inventory depletion. If you need your item to be expedited, we recommend calling Sales at 800-543-1608.

### Order Acceptance

Once your order has been accepted and processed, you will receive an email that will include the shipping carrier and tracking information.

### Shipping and Delivery

Free ground shipping is included to 48 states. Hawaii, Alaska and Puerto Rico ship based on assessed fee at checkout.

We require a physical address for shipping. Sorry, no P.O. Boxes or APO/FPO addresses. Please select 2-day or next day air for shipments to Hawaii or Alaska. Shipping charges are calculated on a per-product basis. Please make note of the shipping charges associated with each item.

**Note:** For safety reasons, we cannot ship products containing lithium-ion batteries via air delivery methods. These items are available to ship via ground service only.

**Note:** For your protection, some orders may require a signature for delivery.