

SOUNDSTREAM

VRN-65HB

2 DIN 6.2' Monitor
DVD/CD/MP3/MP4 Player
AM/FM Radio
Support Bluetooth
Support Mobile Phone link
Build in GPS



Owner's Manual

Take the time to read through this owner's manual.
Familiarity with installation and operation procedures will help you obtain the best
Performance from your new DVD-receiver.

WARNING!

To promote safety, certain functions are disabled unless the parking brake is on. The Unit is designed to detect parked status and must be connected to the power supply side of the parking brake switch. Improper connection or use of his connection may violate applicable law and may result in serious injury or damage. To avoid the risk of damage and injury and the potential violation of applicable laws, this unit is not for use with a video screen that is visible to the driver.

- To avoid the risk of accident and the potential violation of applicable laws, the front Video image feature should never be used while the vehicle is being driven. Also, other video displays should not be in a location where it is a visible distraction to the driver. In some countries or states the viewing of images on a display inside a vehicle even by persons other than the driver may be illegal. Where such regulations apply, they must be obeyed and this unit's DVD features should not be used.
- Please remember to wear your seat belt at all times while operating your vehicle. If you are ever in an accident, your injuries can be considerably more severe if your seat belt is not properly buckled.
- The supplier waves any and all liability when these warnings are not followed.

OPERATION PRECAUTIONS





- Only connect to a 12Vdc battery and negative grounding.
- Avoid placing the product in direct sunlight, in areas with high levels of dust, high temperatures (over 40°C) or high humidity (over 90%). In case of high temperatures, cool down the car interior by means of ventilation or air-conditioning.
- Operate in well ventilated areas.
- Do not turn on or off the product in short intervals. When turning the unit off, wait for at least 10 seconds prior to turning the unit on again. Do not operate the player with scratched, bended or broken discs and when a disc is not loaded properly, do not force it into the player.
- Do not watch video playback while driving which will cause serious danger and risks of traffic accident. It may violate the laws and regulations.
(There may be exceptional case, i.e., using rear view camera and navigation system)
- Do not install the unit where the operation for safety driving is restrained.
- Do not disassembly the unit by yourself, if need repairing, please take the unit to the after service center.
- Do not open and close the monitor manually, it may damage the monitor tilt system.
- Do not touch the LCD screen by hard objects, it may damage or give scratch to the LCD screen.
- If the back of monitor touches dashboard or air-conditioner inlet etc after open the monitor , then setup TILT level in monitor TILT menu to prevent damage from repeat touching.
- Car parking under direct sunlight may increase the temperature inside the car and the unit may not be in proper operation, please try it again after the temperature returns to normal.
- Do not replace the fuse on the power cable without professional guidance, using improper fuse may cause damage to the unit or even cause burn the unit.
- Do not use irregular shaped Disk.
- IR remote control operation may be hindered by monitor when the monitor is opened, thus please use the remote control at the similar level of remote control receiver.
- Do not install the unit where the cooling fan is blocked.

CONTENTS

WARNING!	2
OPERATION PRECAUTIONS	2
CONTENTS	3
ACCESSORIES	3
UNIT INSTALLATION AND REMOVAL	5
WIRING CONNECTIONS	6
PANEL	8
REMOTE CONTROL	9
REMOVE BATTERY	11
MAIN MENU	12
◆ RADIO	12
◆ DVD PLAYER	13
◆ USB/SDMMC INTERFACE OPERATION	13
◆ SETTING CONTROL	14
◆ GENERAL SETTING	14
◆ DATE TIME SETTING	15
◆ NAVIGATION SETTING	15
◆ VIDEO SETTING	15
◆ STEERING WHEEL CONTROL	13
◆ BLUETOOTH SETTING	15
◆ EQ SETTING	15
◆ RADIO SETTING	16
◆ GPS SETTING	16
GPS SECTION	16
MOBILE PHONE LINK SCETION	17
BLUETOOTH SCETION	17
AV-IN MODE	19
OTHER FUNCTIONS	19
NOTES ON DISC	20
TROUBLESHOOTING	21
TROUBLESHOOTING	22
TECHNICAL SPECIFICATIONS	23
BLUETOOTH CONNECTION ATTENTION INSTRUCTIONS	24
VIDEO FILE CONVERSION	25

ACCESSORIES

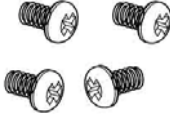
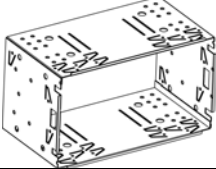
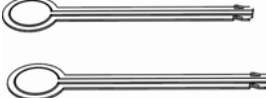
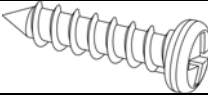
Package contains the following accessories for installation and operation of the unit.

(1) Washer, Spring Washer, M5 Nut	1 each	
(2) Mounting Strap	1	
(3) Bolt	1	
(4) Screw	4	
(5) Mounting Collar	1	
(6) Release Key	2	
(7) Screw	1	
(8) Rubber Cushion	1	



Remote Control



Warranty card

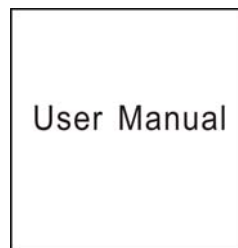

User Manual



GPS cable

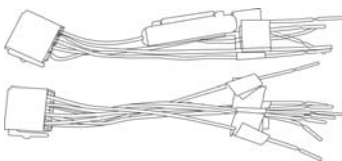

ISO cable



Trim ring

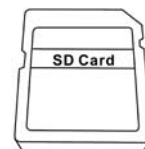

SD card

Note:
Product image may vary from the actual delivery.

INSTALLATION / UN-INSTALLATION

Note

Before starting installation of the unit, make sure the wiring is connected properly. Use only the parts provided with the unit to ensure proper installation.

The use of unauthorized parts may cause malfunction.

Install the unit where it does not get in the driver's way and will not injure the passenger in case there is a sudden stop, like an emergency stop.

◆ INSTALLATION (Figure 1)

- ◆ Insert the unit into dash-board hole and fix it
- ◆ If necessary, place the mount strap at the rear of the unit and fix it with provided washer as figure 2.
- ◆ Place Trim Ring over the unit and installation is completed as figure 1.

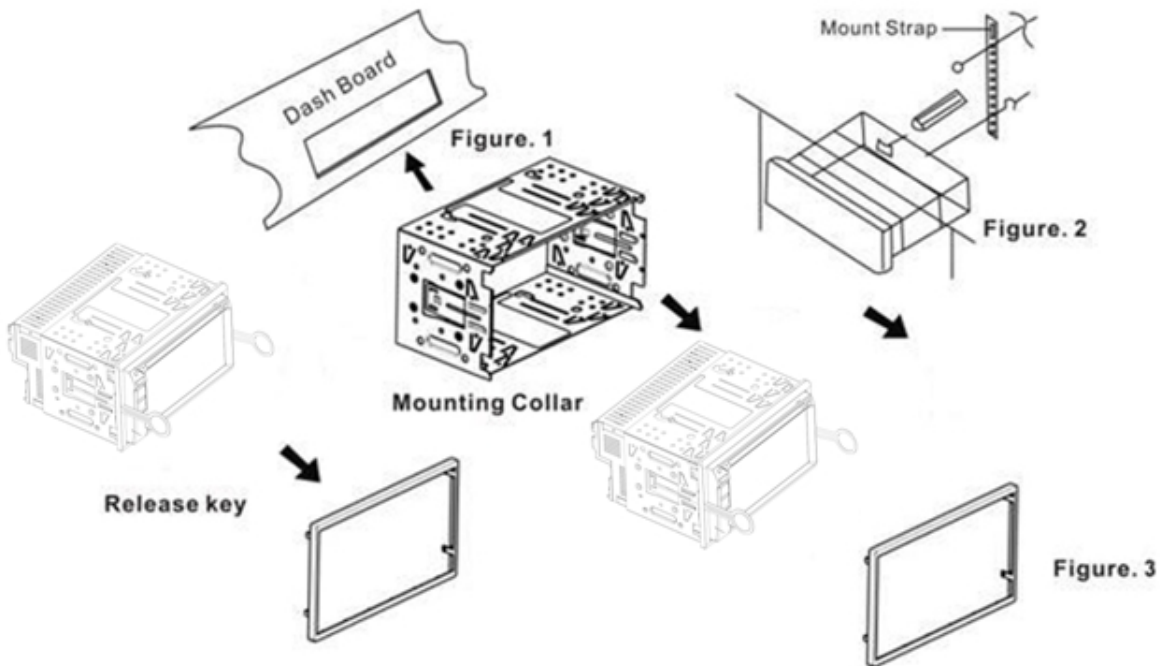

◆ UN-INSTALLATION

Insert the supplied extraction keys into the unit and pull the unit out with keeping the extraction keys. (as Figure. 4)

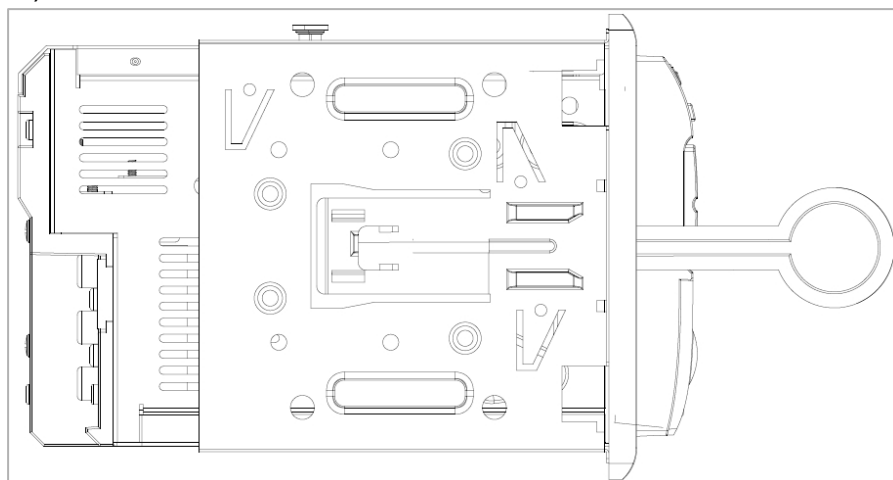

Figure 4

WIRING CONNECTIONS

Make sure you have good chassis ground. A good ground connection will eliminate most electrical noise problems. A good chassis ground requires a tight connection to the vehicle's metal chassis. The area around the ground connection should be clean, bare metal without rust, paint, plastic, dust, or dirt for a good electrical connection.

Caution: Do not interchange the connection of the wiring!!!

For some car models you may need to modify wiring of the supplied power cord. Contact your authorized car dealer before installing this unit.

Using the ISO Connector

1. If your car is equipped with the ISO connector, then connect the ISO connectors as illustrated.
2. For connections without the ISO connectors, check the wiring in the vehicle carefully before connecting, incorrect connection may cause serious damage to this unit.
3. Cut the connector; connect the colored leads of the power cord to the car battery as shown in the color code table below for speaker and power cable connections

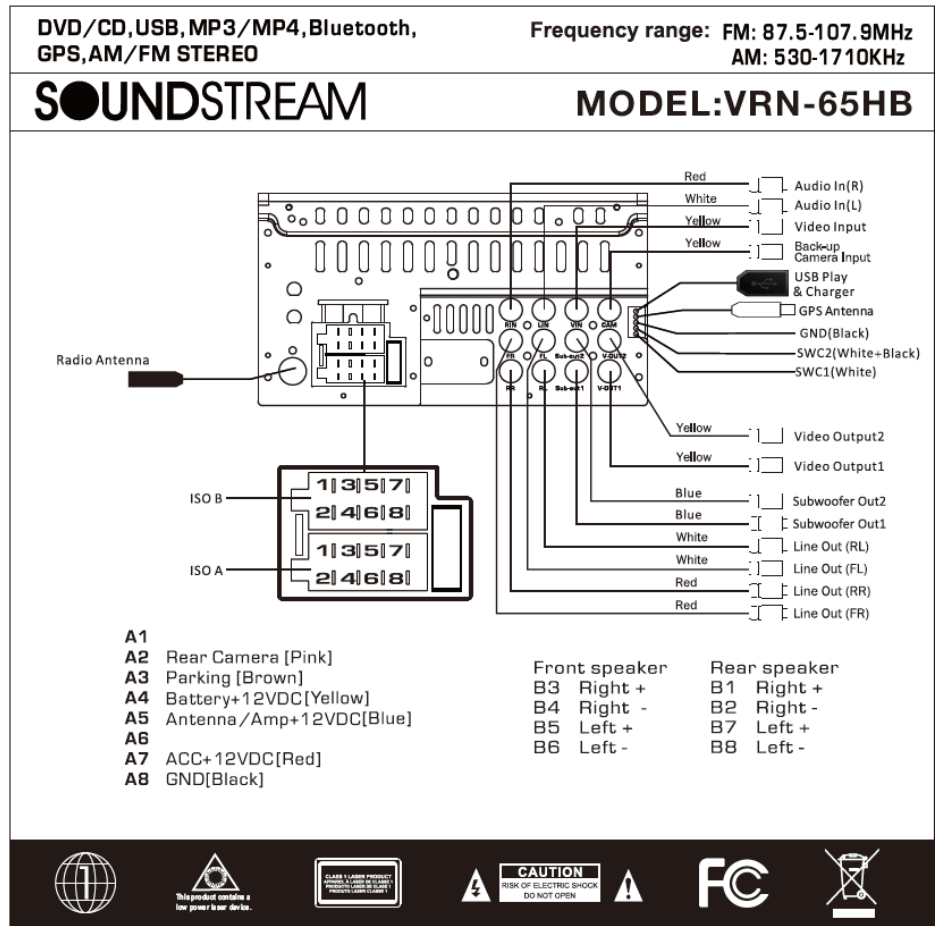

NOTE: Never connect cable to the system while it is connected to the battery power. Whenever the unit is disconnected from the battery, the preset memory will be erased and the unit will go back to its factory defaults.

When the brown cable for steering wheel control connected to the steering wheel, we can use the steering wheel to control some unit

SWC Interface Connections

To use the built-in SWC function, connect SWC-1 (white) and SWC-2 (black/white) to the corresponding SWC wires of the vehicle. Follow the SWC settings described in the SWC Settings section, pg. 15.

To use an external universal SWC module, connect only SWC-2 (black/white) to the output of the module.

Note: To watch video the parking wire should be connected to brake signal. 2 cables are connected to a Hands-Free device (not included).

Parking wire

Note: The parking wire is connected with brake signal; for safety, the programs can be seen on the monitor after braking the car.

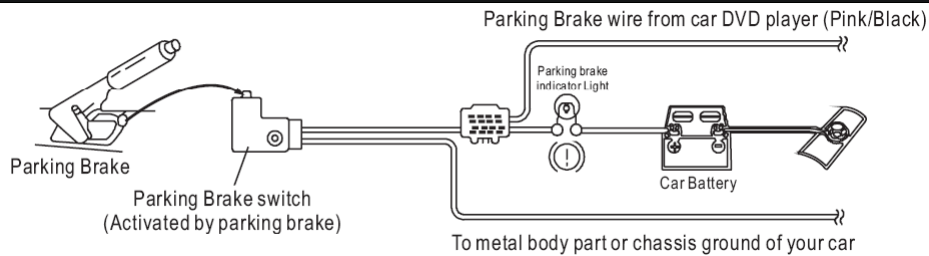

Connecting the reversing line to taillight on the car

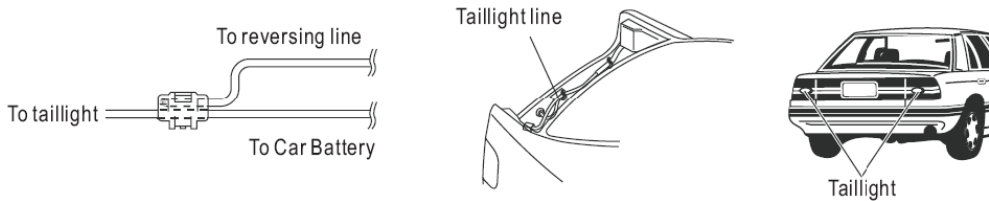

After connecting, when you start up the reverse gear, the unit will receive the picture from car rear view camera.

Note:

- Only use groundless loudspeakers.
- Use only loudspeakers of minimal 40Watt, using fewer watts may result in damaging your loudspeakers at higher volumes.
- Use 4~8 Ω (Ohm impedance) loudspeakers only; using higher or lesser impedance may damage the unit.
- Do not use 3-cable loudspeakers and do not connect the loudspeakers minus to the car body (GND). The unit is using a BTL circuit and each loudspeaker must be connected with insulated cables according the diagram.
- Loudspeaker cables and/or optional external power amplifiers must always be about 30cm away from the antenna and/or antenna extension parts.

Connect the speakers according the following diagram, incorrect connections will damage the unit or your loudspeakers

Correct connection

Left front - Right front | Left rear - Right rear

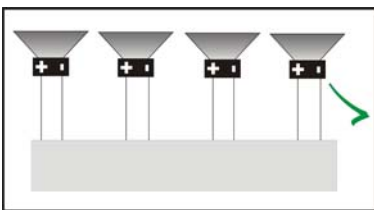

Incorrect connections

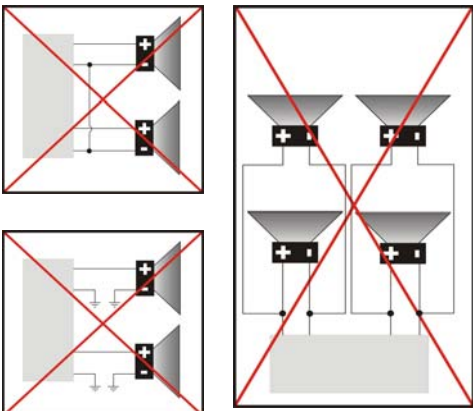

FRONT PANEL

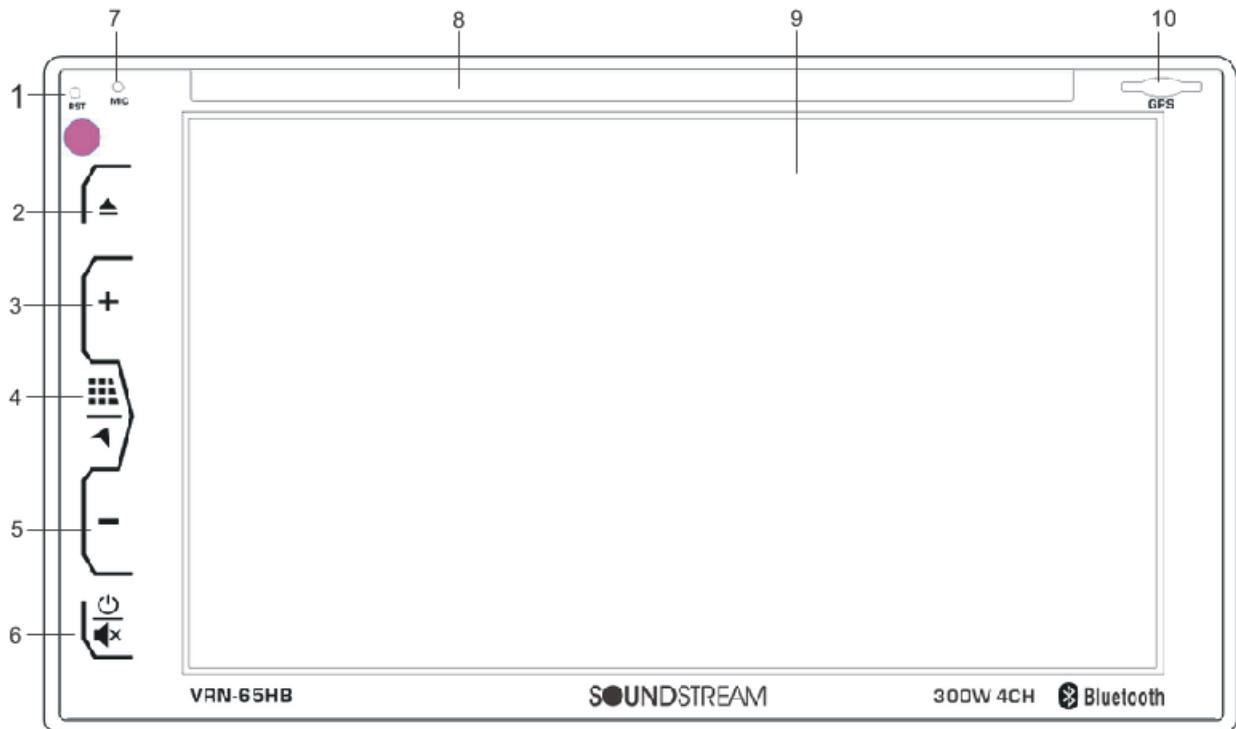

1. IR Sensor

IR Remote control signal receiving window. Max distance is 6-8 meters, 45 angles.

2. EJECT Button

Press to eject a disc. If the disc is not removed for about 10 seconds after eject, the disc is reinserted automatically.

3. VOL Increase (+) Button

Press VOL increase button to increase the volume.

4. Main Menu

Press menu button enter to GPS mode.

5. VOL Decrease (-) Button

Press VOL decrease button to decrease the volume.

6. POWER/MUTE Button

Press it to turn on the unit. Press and hold for 2 seconds to turn the unit off. Press the button briefly to Mute. Please note that the volume will be muted on all audio output connector.

7. MIC

8. DISC Slot

9. Info Display

Information Display LCD when operation the unit.

10. GPS Slot

REMOTE CONTROL

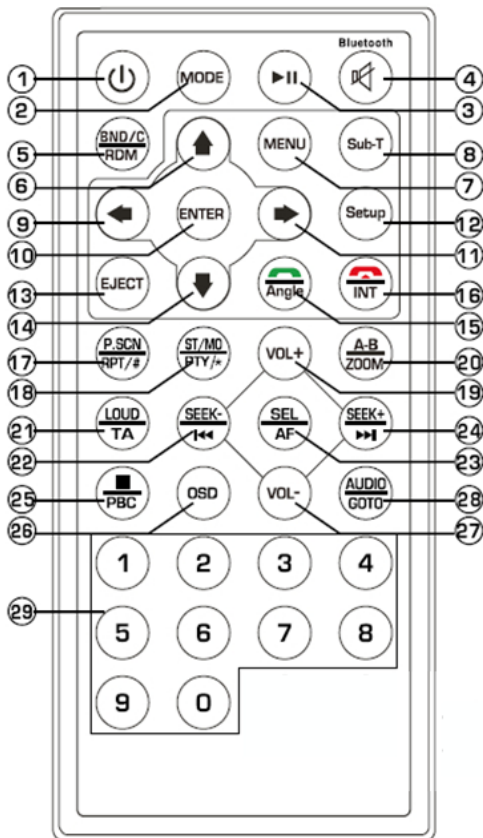

- | | |
|---|----------------------------|
| 1 Power ON/OFF | 3 Play/Pause |
| 2 MODE | 4 Mute/Bluetooth |
| 5 BAND/RDM
Clear(Only for BT) | 7 MENU |
| 6 UP Arrow | 8 Sub-t |
| 9 Left Arrow | 11 Right Arrow |
| 10 Enter | 12 Setup |
| 13 Eject | 15 Angle |
| 14 Down Arrow | 16 INT
(Only for BT) |
| 17 P.SCAN/RPT
#(Only for BT) | 19 VOL+ |
| 18 ST/MO
PTY(Only for RDS)
*(Only for BT) | 20 ZOOM/A-B |
| 21 LOUD
TA(Only for RDS) | 23 SEL
AF(Only for RDS) |
| 22 SEEK- / ◀◀ | 24 SEEK+ / ▶▶ |
| 25 STOP/PBC | 27 VOL- |
| 26 OSD | 28 AUDIO/GO TO |
| 29 Number Key | |

Note:

- 1 AF just for RDS model
- 2 TA/PTY for RBDS/RDS model
- 3 * # (Green/Red icons) Bluetooth
- These Functions for Bluetooth Models
- 4 EJECT
Optional function

1. POWER

Power on or off.

2. MODE button

Press it to select the mode: Radio, DISC (if there is a disc in unit), USB (if there is a USB device in the unit), CARD (if there is a SD/MMC card in the unit) and AV IN.

3. PLAY/PAUSE button

In DVD mode, press it to pause playback, press again to resume.

4. Mute/Root button

✖ Short press this button to mute the volume output, press it again to resume volume.

5. BAND/ RDM (Only for Bluetooth)

In Radio mode, press to change radio band in sequence of FM1 → FM2 → FM3 → AM1 → AM2

In DVD mode, press it to play randomly.

In Bluetooth mode, press it to clear number.

6. Cursor ▲ buttons

Use the ▲ buttons to select the menu item, the title track or to show next frame.

7. MENU/ROOT button

Short press it to show main menu,.

In DVD mode, long press it to enter TITLE MENU (Enable only if the DVD disc with title menu).

8. SUBTITLE button

Press it to select the subtitle language (Available only if the disc with subtitle function).

9. Cursor ◀ buttons

Use the ◀ buttons to select the menu item. the title, track or to show next frame.

10. ENTER button

Press it to confirm selection or setting.

11. Cursor buttons

Use the  buttons to select the menu item, the title track or to show next frame.

12. SETUP button

In DVD mode press it to enter the setup menu.

13. EJECT button

Press it to eject the disc.

14. Cursor buttons

Use the  buttons to select the menu item. the title, track or to show next frame.

15. ANGLE/ACCEPT button (Only for Bluetooth)

In DVD mode, press it repeatedly to change the viewing angle (Available only with a recorded DVD file or DVD disc that has this function).

In BLUETOOTH mode, press to make a call after inputted a phone number or accept an incoming call.

16. INT / REJECT button (Only for Bluetooth)

Press it to activate the intro function. You can play the beginning of every track for 10 seconds in sequence.

In BLUETOOTH mode, press to reject a coming call or hang up while calling.

17. P.SCN/ RPT

In SD CARD/ USB mode, press to repeat REP 1 => REP DIR => REP ALL

In DVD mode, press to start repeat REP OFF=>REP Chapter=>REP Title=>REP Off.

In Radio mode: PS (Preset Scan): Press to scan all preset stations in the memory of the current band and stay on each memory stations for about 5 seconds.

AS (Auto Save): Long press to save the stations with good reception automatically.

18. STEREO/MONO (PTY only for RDS/ Bluetooth)

Press STEREO button to select STEREO or MONO.

19. VOL+ button

Press to increase volume level.

20. A-B/ZOOM button



During playback, press it at the starting point of section you want to repeat(A), press this button again at the ending point of the section you want to repeat (B), section A-B repeating starts. Press it again to cancel the A-B repeat function.



Press it and hold for two seconds in DVD mode to zoom the image in or out in the sequence of ZOOM 2-> ZOOM 3-> ZOOM 4-> ZOOM 1/2-> ZOOM 1/3-> ZOOM 1/4.

21. LOUD (only for RDS)

Press to set LOUD on or OFF.

22. / seek- button



In DVD mode, Press  button to skip to the previous track. Press and hold  button for two seconds to activate fast reverse (REW) search in a track.



In RADIO mode, press  button to start searching automatic, press and hold for two seconds to start manual searching.  button Frequency down.

23. SEL button (only for RDS)

Press it to enter the SOUND SETTING menu, and press Cursor UP/DN buttons to choose an item and press cursor left/right buttons to set the item. Press SEL button again to exit the menu.

24. / seek + button

In DVD mode, Press  button to skip to the next track, press and hold  button for two seconds to activate fast forward (FF) search in a track.

In RADIO mode, press  button to start searching automatic, press and hold for two seconds to start manual searching  button Frequency up.

25. STOP/PBC button

Press it to Stop playback from the current position, press it again to final stop to the very beginning. Press PLAY/PAUSE button to play.

Press and hold for two seconds to set PBC on/ off in VCD mode.

26. OSD button

In DVD mode press it to enter the OSD menu, press and hold for 2 seconds to set video setup. (RED /GREEN /BLUE /BRIGHT / CONTRAST /SHARP /COLOR RESET /BACK)

27. VOL- button

Press to decrease volume level.

28. AUDIO/GOTO button

In DVD mode press it to select the audio language.

In VCD mode, press it to select the sound track in the sequence of MONO L =>MONO R =>STEREO.

Go to: in DVD mode, press and hold for 2 seconds to show TIME SEARCH menu, select number and confirm to go to certain position directly. When press  button to enter TITLE/CHAPTER selection mode, select number and confirm to go to certain TITLE or CHAPTER position directly.

29. Digit 0-9 buttons

In radio mode, select 1-6 the desired band; In DVD mode, select track.

Noted: The RC is the universal and full-featured. Some options are available with the corresponding model.

REMOVE BATTERY

Note:

- The distance may vary according to the brightness of ambient light.
- If the remote is not used for an extended period of time, remove the battery to prevent possible damage from battery leakage and corrosion.
- Do not place any objects between the remote control unit and the sensor on the unit.
- Do not drop the remote control onto the floor; it will damage it beyond repair.
- Do not use the remote control unit, while simultaneously operating the remote control unit of any other equipment; they may interfere resulting in improper operation.
- The battery normally last for about one year although depending how often the remote control is used. If the remote control unit isn't working even when it is operated near the unit, replace the battery with a new battery of the same make and use only a lithium cell battery type: CR2025 (3V).
- Dispose empty batteries in accordance with your local governmental regulations.
- Do not short-circuit, disassemble, heat or dispose of fire or flames the battery.
- Keep the battery out of reach of children, should the battery be swallowed, immediately consult a doctor.

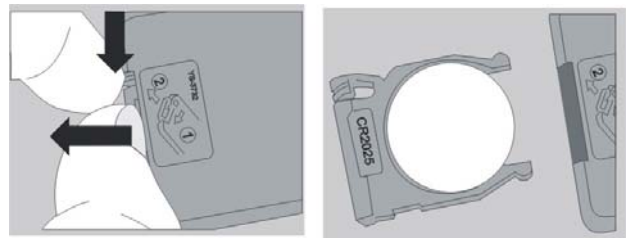

MAIN MENU

The best way to discover the program is to explore each screen in detail, and to find out how to move from one to another. Read this chapter for a guided tour.

Unit starts by displaying the Main menu. This is the root of the screen hierarchy, and you can simply access all features by tapping on the touch screen buttons.

Tap the icons to enter a desired mode.



◆ RADIO PLAYER

To start Radio, tap RADIO button on main menu screen.

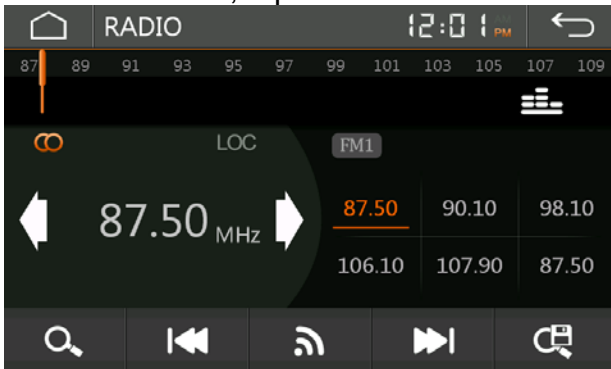

Touch this button to go into home page.



Return button.



Touch this button to select program type.



Touch this button to search backward stations.



Touch this button can choose FM1=>FM2=>FM3=>AM1=>AM2.



Touch this button to search forward stations.



Touch this button can scan the stations from 1-6, Long touch it to save the stations with Good reception automatically and scan each station for about 5 seconds.



Touch this button adjust the EQ, it can choose User =>Rock =>Pop=> Jazz=>Electric =>Flat => User.

Note: When a radio signal is not received, the default for ST / MO function, once received radio function automatically converted to ST.

◆ DVD PLAYER

To start DVD Player, tap DVD icon from main menu screen.

TOUCH SCREEN MENU

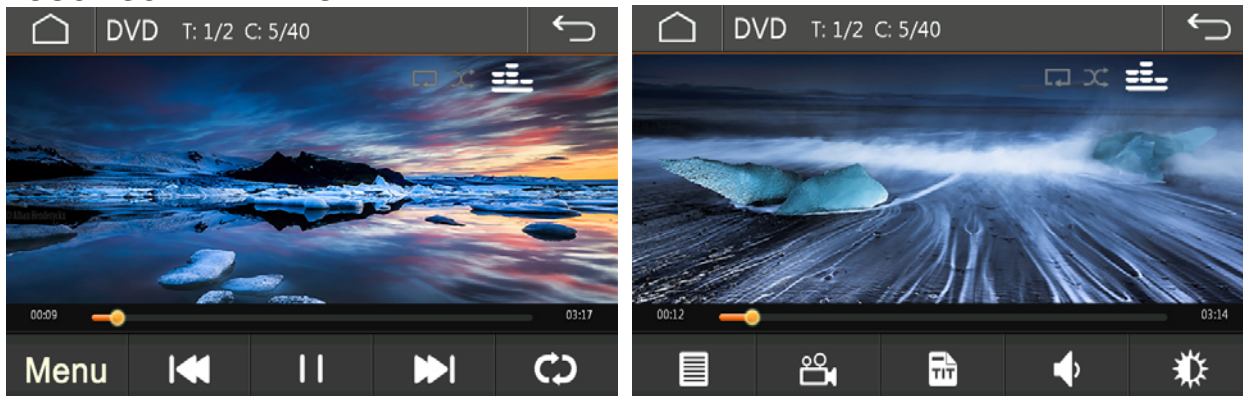

Menu

In DVD mode touch it return to DVD menu.

PBC

In VCD mode touch it can choose PBC ON or OFF.



Touch it to skip to the previous track.



Touch it to pause/play.



Touch it to skip to the next track.



Press it to repeat REP CH => REP TT => REP ALL.



Touch it to select Subtitle 1/2=> Subtitle 2/2=> Subtitle off.



Touch it repeatedly to change the viewing angle.



Touch it to select title



In DVD mode, touch it to select Audio 1/2=> Audio 2/2.

In VCD mode, touch it to select sound track in the sequence of left=>right=>mixed=>stereo.



Touch this button adjust the screen backlight and color.



Touch this button adjust the EQ, it can choose User =>Rock =>Pop=> Jazz=>Electric =>Flat => User.

Note:

1. DVD Player will automatically start playing when you insert any DVD disc, MEMORY card or USB device.
2. Warning displays if the vehicle is moving for driver's safety.
3. DVD Player will not only play video, but also picture and music files as well.

◆ USB INTERFACE OPERATION

USB Disk

When a USB is played, the screen will show following interface:

To play MP3/ MP4 files from a USB flash memory, insert a USB flash memory into the USB port on the back of the unit. The unit will play automatically MP3/MP4//JPEG files.



Press it to select songs.



Press it to select move or video file.



Press it to select pictures.



Press it to search USB files.



Press it to search song, move, and video or picture files.



Press it to turn on / turn off track randomly playback.



Touch it to skip to the previous track.



Play/pause button.



Touch it to skip to the next track.



Press it to repeat REP CH => REP TT => REP ALL.



Touch this button adjust the EQ, it can choose User =>Rock =>Pop=> Jazz=>Electric =>Flat => User.



Touch it to enter TITLE MENU (you can choose music, move, picture and Video to play).

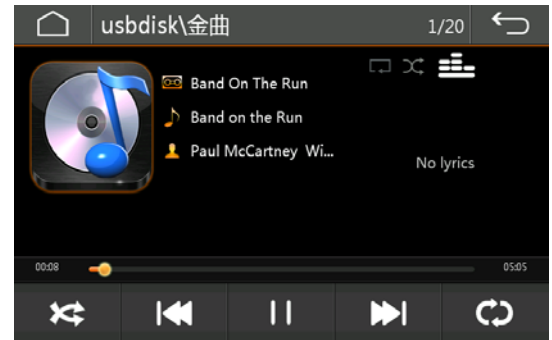
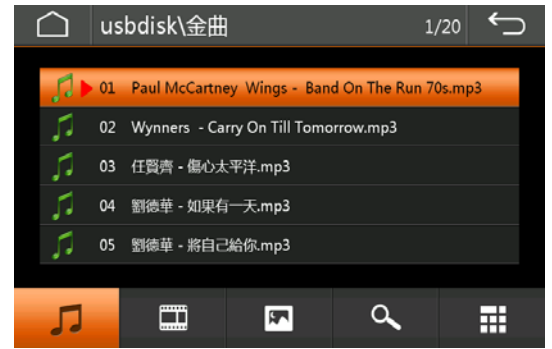

◆SETTING CONTROL

To start SETTING, tap SETUP icon on main menu. Your device has default system settings. You can customize the settings to suit your personal needs. Once you change settings, your new settings will remain until you change it again.



Setup 1



Setup 2

General

	<p>Language: Press it choose English, Portuguese, Japan...and act.</p> <p>Screen Touch Sound: Turn on or off.</p> <p>Lighting Detect: Turn on or off.</p> <p>Screensaver: Choose screen savers and wait time.</p> <p>Reset : Press it can reset all settings.</p> <p>About : Press it can see the software version.</p>
--	---

Date Time

	<p>24-Hour Time :Turn on or of the 24 hour time.</p> <p>Set Automatically :Turn on or off automaticly set dateand time.</p> <p>Time Zone:Press it can choose time zone.</p>
---	---

Navigation

	<p>Navi Gain: Adjust Navi volume.</p> <p>Dissble media play when navigating: Turn on or off dissble media play when navigating.</p> <p>Auto run: Turn on or off the auto run map.</p> <p>Navi path: Press it can select the Navi path.</p>
---	--

Video

	<p>Rear Camera Mirror: Turn on or off the rear camera mirror.</p> <p>Brightness/ Contrast/ Hue/ Saturation: Through the digital level can adjust what you want the brightness, contrast, hue and saturation.</p> <p>Colorful/Soft/Reset: Press it to choose backlight effect colorful, soft or reset.</p>
--	---

SWC

	<p>Please make sure unit connect SWC1 wire fist, and then press the wheel button, then press the corresponding button on screen.</p>
---	--

Bluetooth

	<p>Auto connect: Turn on or off auto connect with head unit Bluetooth.</p> <p>Auto answer: Turn on or off auto answer calling when phone successfully connected Bluetooth.</p> <p>Paring code: Setting the paring code</p>
---	--

EQ

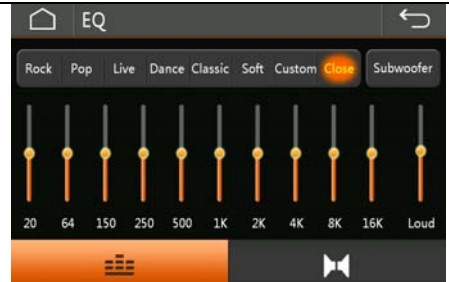
	<p>Sound Effect: Adjust EQ and balance surround and field.</p> <p>Touch EQ button choose Rock, Pop, Live, Dance, Classic, Soft, Custom and close.</p> <p>Touch balance button adjust balance surround and filed.</p>
---	--

Radio Area

	Radio Area: Can choose radio area Asia, Japanese, Russian, North America and Middle East.
---	---

GPS Information

	Radio Area: Can choose radio area Asia, Japanese, Russian, North America and Middle East.
---	---

GPS SCETION

To start GPS mode, please insert SD card in GPS slot on the front panel. Firstly tap SETUP icon on main menu and enter to Navigation setting; secondly choose Navigation path and return main menu; thirdly touch GPS icon on main menu or tap main button on the panel enter to GPS. You can choose road and run GPS.

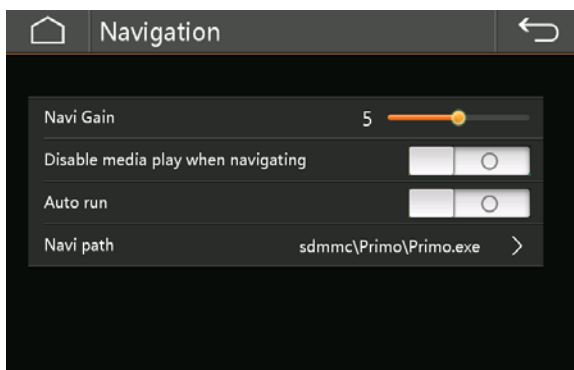

Navigation setup



Enter to GPS

MOBILE PHONE LINK SCETION

Note: Mobile phone link function can only be available:

*Used for Android system phone. Do not support iphone till now.

*Set your phone to debug mode.

When start to operate phone link function, firstly set the phone to USB debug mode; connect the USB cable with mobile phone; then confirm your phone has already connected with unit via Bluetooth, and then tap Phone link icon on the main menu enter to Phone link mode.

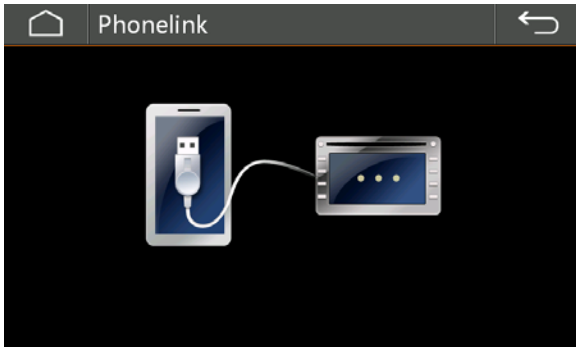

BULETOOTH SCETION

Warning: Driving and having a Telephone conversation at the same time is dangerous, please park your car before having a telephone conversation. The supplier waves any and all liability when this warning is not followed.

To enter Bluetooth mode, you can tap Bluetooth icon on Main menu or long press the mute/Bluetooth button on the Remote Control or press mode button on remote or on front panel.

Disconnect Bluetooth

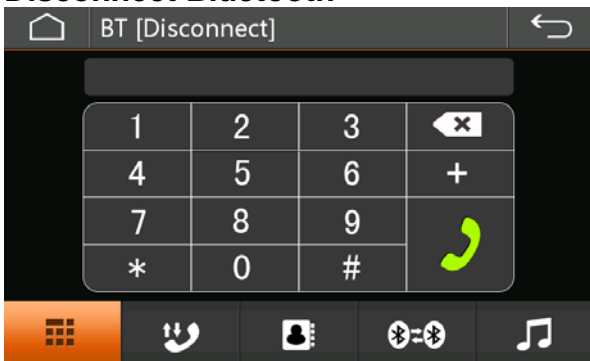

A user can make own choice by tap the buttons.



Tap Dial button to enter call mode.



Tap this button can see missed, received and dialed calls.



Tap this button can see phonebook.



Tap this button can see previous successfully connected mobile phone and unit Bluetooth information.



Tap Music button to start Bluetooth Music player.



Tap this button Making and accept calling.



Tap this icon to clear number.

Pairing Mode

At the 1st time when using BLUETOOTH, you need to pair the mobile phone first. When a phone has not been paired with the unit, the BT icon and Pairing mark will blink continually on the panel.

When the unit has connected with a phone, the BT icon will turn on and the Mobile phone name (if available) will be displayed on the panel.

According to the mobile pairing device manual, after searching for a new device (SoundStream), select it, input password "0000" and confirm OK, device pairing is finished.



The text 'Enter Number' will show on the panel after the pairing is completed. It means the device is connected and ready for BLUETOOTH communication.

Auto-connect – Disconnect

When power on the unit, the last paired phone will be connected to the device via Bluetooth automatically, after searching about one minute, if the device cannot find the paired phone, it will stop searching. When in standby mode (unconnected), long press Bluetooth button on remote control to activate auto-connect function and the device will search for the last paired phone. If you want to disconnect the Bluetooth connection, turn off the Bluetooth on the phone.

1. Dial BUTTON

Tap on Dial button to enter call mode.

In Call mode, the unit can be used as your phone. Making and receiving calls are possible with BLUETOOTH. Simply tap phone number and tap  button to make a call, and tap  button to hang up.

1.) Tap  button shortly to delete a wrong digit, or press Reject/INT button on remote to delete all the numbers at once.

2.) Tap  button the device automatically makes a call to the latest call in its call log.

Voice Transfer

During a call, you can change a call from Bluetooth mode to phone by tapping Transfer button. To have a call in Bluetooth mode again, tap Transfer button.

NOTE: the phonebook only supports Western Characters. Any difference in character will be shown such as "+, * or #"

2. (A2DP) Music Mode

Tap Music button to listen music in Bluetooth mode. You can select the function with the key for previous, play or pause, stop and next.

A2DP (Advanced Audio Distribution Profile) Music Player

A2DP is a function which can receive the audio frequency signal from the mobile phone, amplified by the car audio and played out by the car speakers.

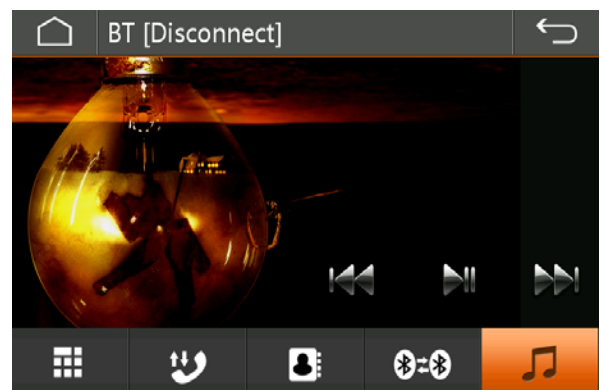

Notice: your mobile phone needs to support A2DP.

Tap the buttons on the screen as shown, or press corresponding buttons (PAUSE/PLAY, STOP, PREVIOUS/NEXT) on remote control to play, pause, play previous, or next music file.

AV IN MODE

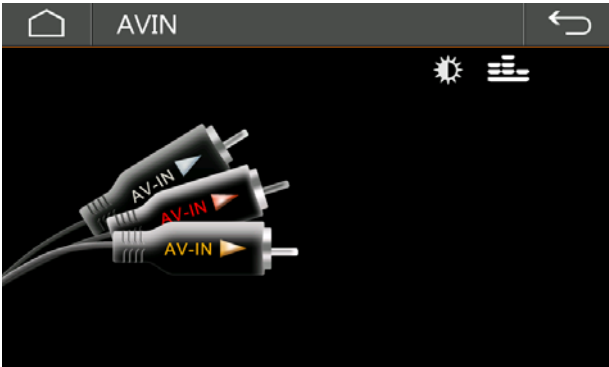

To start AV-IN Mode, tap on AV-IN button from main menu screen. Connect the external audio/video signal source to this unit. Select AV-IN mode in the main menu.

Note: If there is no external video input, the TFT displays "Warning".



OTHER FUNCTIONS

Subwoofer

Connect the subwoofer to the unit using sub output (see electrical diagram).  Tap it on screen enter into main menu setting choose EQ, or touch  this icon directly enter to EQ mode set subwoofer ON to enable subwoofer.

Parking

When the car is stopped and the parking brake is working, the screen can display the video image, otherwise the screen can't display the video image

Back View Camera

This unit is equipped with back view camera output. The camera is used to observe the situation behind the vehicle when you are backing the car.

Please connect your back view camera with the back car video input. And connect the reverse wire for back a car with the rear gear light. Rear view camera picture will be enabled when you are backing the car.

NOTES ON DISC

- ✧ Only use groundless loudspeakers.
- ✧ Use only loudspeakers of minimal 40Watt, using fewer watts may result in damaging your loud speakers at higher volumes.
- ✧ Use 4~8 Ω (Ohm impedance) loudspeakers only; using higher or lesser impedance may damage the unit.
- ✧ Do not use 3-cable loudspeakers and do not connect the loudspeakers minus to the car body.
- ✧ (GND). using a BTL circuit and each loudspeaker must be connected with insulated cables according the diagram.
- ✧ Loudspeaker cables and/or optional external power amplifiers must always be about 30cm. away from the antenna and/or antenna extension parts.
- ✧ If want to display for 7" TFT, parking wire must be connected to ground.

Handling discs

Handling

When holding
With both hands



When holding
with one hand



- Do not use damaged (cracked or warped) discs.
- Do not scratch the signal surface or let it get dirty.
- Do not attach paper or seals to discs. The player may be damaged if there is any exposed glue, etc., On discs. For rental discs in particular, extra labels are often attached to the discs. Check carefully for any exposed glue before using such discs.

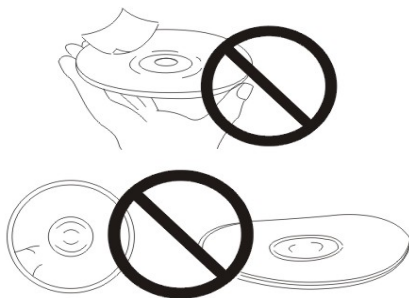

Storing discs

- Always place discs in their case and store them vertically. Avoid storing discs in hot or humid places, places exposed to direct sunlight and places in which the temperature is extremely low.
- Read any cautions included with the discs carefully.

Cleaning discs

- Fingerprints or dust on discs may reduce sound or picture quality. Remove them by gently wiping the disc from the center toward the edges using a soft cloth.

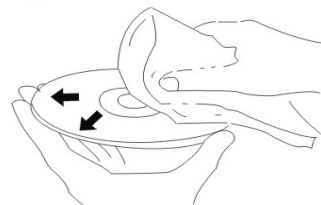

- Do not use benzene, thinner or other volatile chemicals. Do not use record spray or antistatic spray either.
- We recommend using the separately sold cleaning set to clean discs.
- For tough dirt, apply some water to a soft cloth, wring out thoroughly wipe off the dirt, then wipe the disc with a dry cloth.

Irregular shaped discs

Irregular shaped discs (heart-shaped discs, hexagonal discs, etc.) cannot be played on this player. Doing so could damage the player. Never use such discs.



TROUBLESHOOTING

	Symptom	Cause	Remedy
General	Power does not turn on. (No sound is produced.)	Fuse is blown	Replace with fuse of the same amperage. If the fuse blows again, consult your store of purchase
		In correct wiring	Consult your local retailer.
	No sound output when operating the unit with amplifiers or power antenna attached.	Power antennal lead is shorted to ground excessive current is required or remote on the amplifiers or power antenna.	1. Turn off the unit. 2. Remove all wires attached to the power antenna lead. Check each wire for a possible short to ground using an ohm meter. 3. Turn on the unit. 4. Reconnect each amplifier remote wire to the power antenna lead one by one. If the amplifiers turn off before all wires are attached, use an external replay to provide remote-on voltage (excessive current required).
			Nothing happens when buttons are pressed. Display is not Accurate
		Panel or main unit Connectors are dirty	Wipe the dirt off with a soft cloth moistened with cleaning alcohol.
CD	Sound is bad directly after power is turned on.	Compact disc is dirty	Clean the compact disc without scratches
		Compact disc is heavily scratched or warped	Replace with a compact disc without scratches.
	Sound is bad directly after power is turned on.	Water droplets may form on the internal lens when the car is parked in a humid place	Let it dry for about 1 hour with the power on.
LCD	Small LCD display error massage	When deck mechanism error, show ERROR 1	Reset the unit.
		When disc or servo error, it show ERROR 2	Change the disc or reset the unit.
		When USB error, t show ERROR 3	1.Remove the USB and insert it again 2. File error, please check the file. 3. Reset the unit.

TROUBLESHOOTING

SYMPTOM	CAUSE	SOLUTION
NO POWER	THE CAR IGNITION IS NOT ON.	IF THE POWER SUPPLY IS PROPERLY CONNECTED TO THE CAR ACCESSORY SWITCH THE IGNITION KEY TO "ACC".
	THE FUSE IS BLOWN.	REPLACE THE FUSE.
DISC CANNOT BE LOADED.	PRESENCE OF DISC INSIDE THE PLAYER	REMOVE THE DISC IN THE PLAYER THEN PUT A NEW UPWARD.
DISC CANNOT BE READ.	INSERTING THE DISC IN UPSIDE DOWN.	INSERT THE COMPACT DISC WITH THE LABEL FACING UPWARD.
	COMPACT DISC IS EXTREMELY DIRTY OR DEFECTIVE.	CLEAN THE DISC OR TRY TO PLAY A NEW ONE.
	TEMPERATURE INSIDE THE CAR IS TOO HIGH.	COOL OFF UNTIL THE AMBIENT TEMPERATURE RETURNS TO NORMAL.
NO SOUND	VOLUME IS IN MINIMUM.	ADJUST VOLUME TO A DESIRED LEVEL.
	WIRING IS NOT PROPERLY CONNECTED.	CHECK WIRING CONNECTION.
THE OPERATION KEYS DO NOT WORK.	THE BUILT-IN MICROCOMPUTER IS NOT OPERATING PROPERLY DUE TO NOISE.	PRESS THE POWER BUTTON FOR ABOUT 10 SECONDS TO RESET THE UNIT.
	FRONT PANEL IS NOT PROPERLY FIX INTO ITS PLACE.	
SOUND SKIPS.	THE INSTALLATION ANGLE IS MORE THAN 30 DEGREES.	ADJUST THE INSTALLATION ANGLE TO LESS THAN 30 DEGREES.
	THE DISC IS EXTREMELY DIRTY OR DEFECTIVE.	CLEAN THE COMPACT DISC/TRY TO PLAY A NEW ONE.
THE RADIO DOES NOT WORK, THE RADIO STATION AUTOMATIC SELECTION DOES NOT WORK.	THE ANTENNA CABLE IS NOT CONNECTED THE SIGNALS ARE TOO WEAK.	INSERT THE ANTENNA CABLE FIRMLY SELECT A STATION MANUALLY.

TECHNICAL SPECIFICATIONS

General	
Power supply:	11~16V DC
Current consumption:	max. 10 A
Maximum power output:	4 x 50W channels (max)
Compatible formats:	DVD/VCD//MP3/MP4/VIDEO/CDDA/PIC TURE CDCD-R/-RW/DVD±R/±RW PLAYBACK
Dimensions (W x D x H) / weight:	178*165*100 mm/2 kg
Working temperature range:	-20°C - +60°C
ESP function:	10 sec. for Audio CD, 120 sec. for MP3
TFT display	
Screen size:	6.2inch
Resolution:	800*480 pixel
Aspect ratio:	4:3/16:9
Brightness:	460 cd/m ²
Contrast ratio:	500:1
FM Stereo Radio	
Frequency range(Europe Area):	87.5 – 108MHz(Step 50KHz)
Frequency range(U.S.A Area):	87.5 – 107.9MHz(Step 100KHz)
Frequency range(South America Area):	87.5 – 108MHz(Step 50KHz) 65-74MHz(Step 10KHz)
Frequency range(Russian Area):	87.5 – 107.9MHz(Step 200KHz)
Frequency range(Asia Area):	87.5 – 108MHz(Step 100KHz)
Preset memory stations:	18
AM/MW Radio	
Frequency range(Europe Area):	522kHz - 1620 KHz(Step 9KHz)
Frequency range(U.S.A Area):	530kHz - 1710 KHz(Step 10KHz)
Frequency range(South America Area):	520kHz - 1710 KHz(Step 10KHz)
Frequency range(Russian Area):	522kHz - 1620 KHz(Step 9KHz)
Frequency range(Asia Area):	531kHz - 1602 KHz(Step 10KHz)
Preset memory stations:	12
Audio specification	
Frequency response:	20 Hz-20 KHz
USB interface	
USB type	USB 2.0 full speed
Support format	mp3 , wma, mpeg1, mpeg2, avi

Specifications are subject to change without notice. Mass and dimension are approximate.

!!ATTENTION INSTALLER!!

Bluetooth Connection Instructions



1. To enter Bluetooth mode, you can tap Bluetooth icon on Main menu or long press the “mute”/”Bluetooth” button on the Remote Control, or press “mode” button on remote or on front panel to select bluetooth mode.

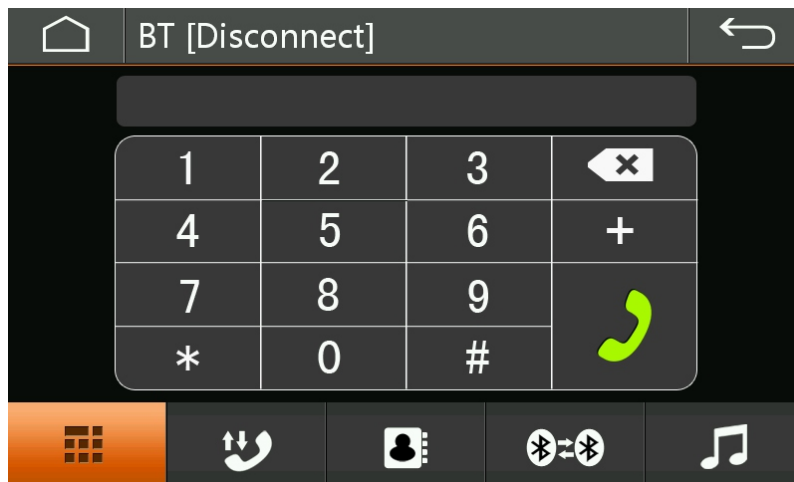

2. At the 1st time when using BLUETOOTH, you need to pair the mobile phone first.

3. Place your Bluetooth Enabled cell phone in pairing mode.

4. Connect your phone to the radio, using the pass code 0000

Video File Conversion 101

File compression seems to be name of the game to see who can fit the most music and video onto today media deices. Unfortunately with so many compression formats and codecs, it becomes virtually impossibly for your head unit to support the multitude of song and video file types. To overcome the confusion of what video formats are compatible with this head unit, we suggest using a file converter to align the stars and change the many video file types you have to one standard.

Surely there are many file conversion apps available on the line, but CNet seems to be a reliable source and has a good file conversion app available. Check out:

http://download.cnet.com/FreeAVItoVideoConverter/30002194_475685273.html

Drop by our website for the link instead of typing a million letters and symbols into your web browser?

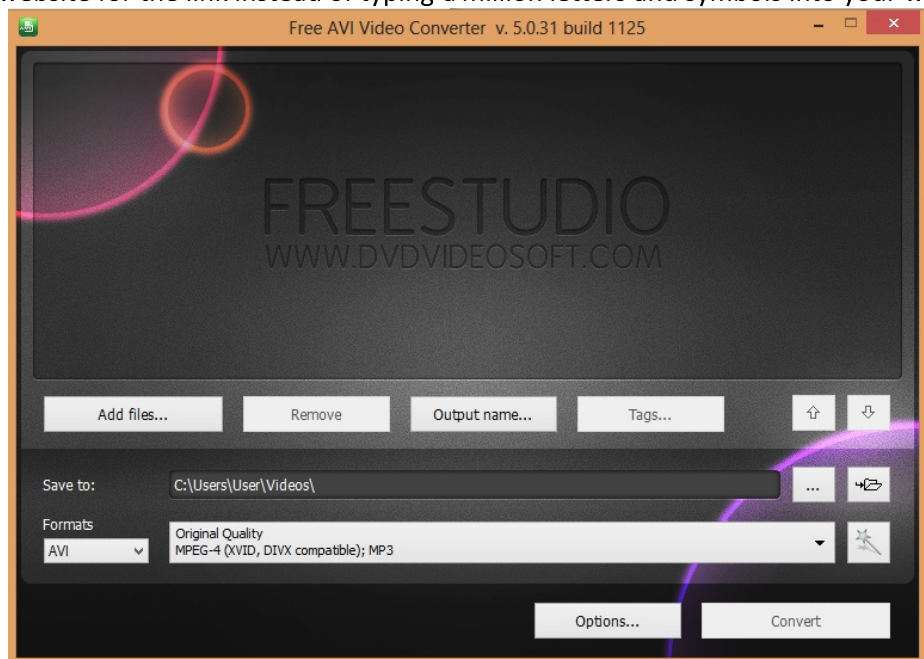

After the app downloads and installs, its pretty simple to convert your files. Select the Add File button and browse your computer to find the alien file type you need to convert. The file info should appear at the top:

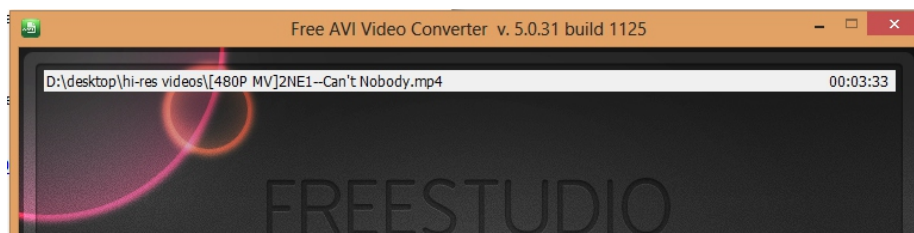

There are some optional choices after the file is selected, like changing the name to protect the innocent, or change the location the converted file is saved. If you feeling frisky go for it:

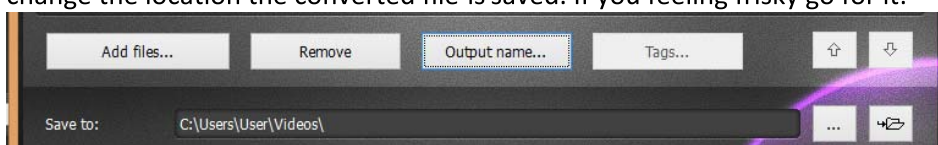

Video File Conversion 101

Otherwise, choose the file format you want to convert your movie to. May we recommend the AVI:

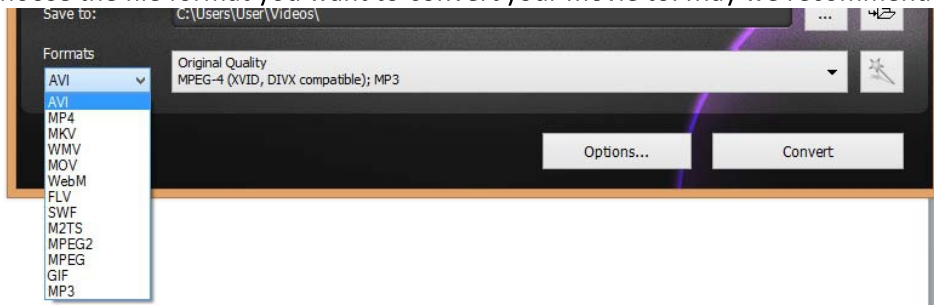

You can also choose the resolution for the screen size and type. If you're converting an original file that is super high quality resolution, you might consider the HD options, but most commonly you should choose Normal Quality or Original Quality.

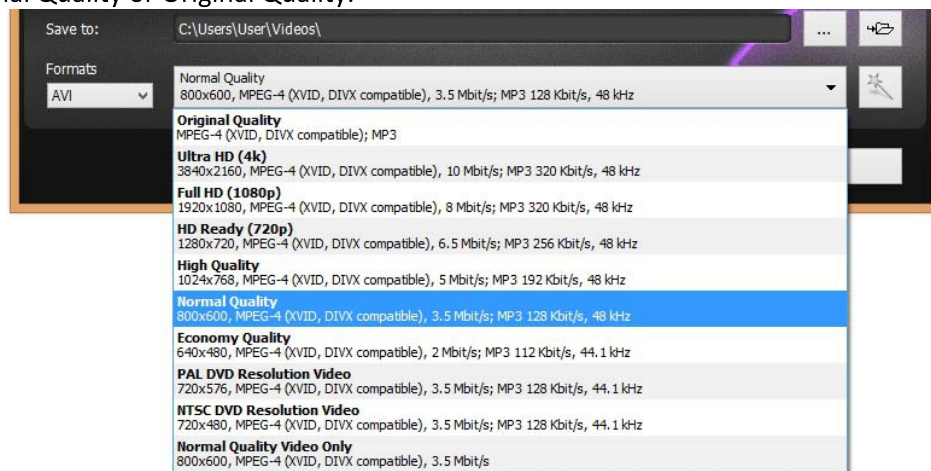

There are some fantastic options to change the standard codec, bit & frame rates, blood types, and so on, but we suggest keeping everything preset as the app recommends. It's these crazy variables that brought you here in the first place.

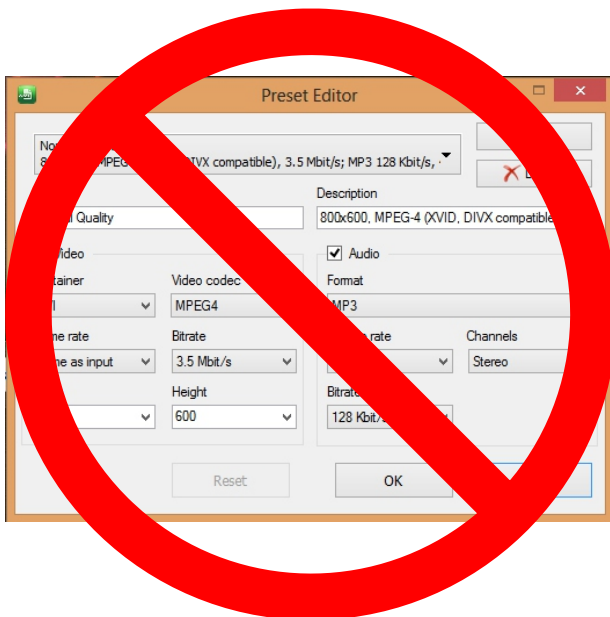

Finally, click convert and wait for the bell:

