

Nooie Cam Indoor 1080P

Quick Start Guide

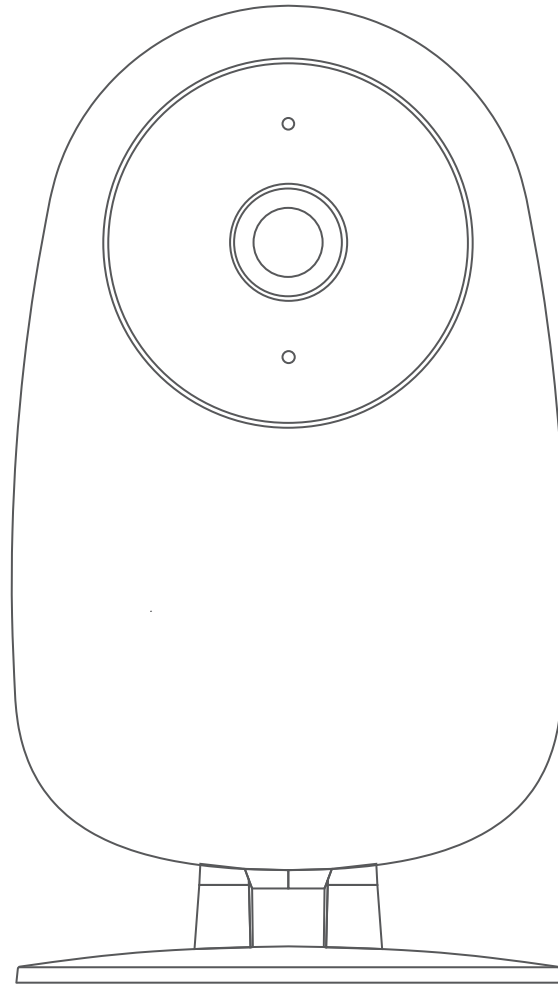

nooie

In The Box



Camera



3M
Sticker



Power
Adapter

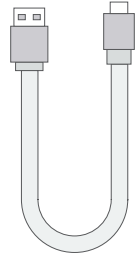

Power
Cable

Look Closer

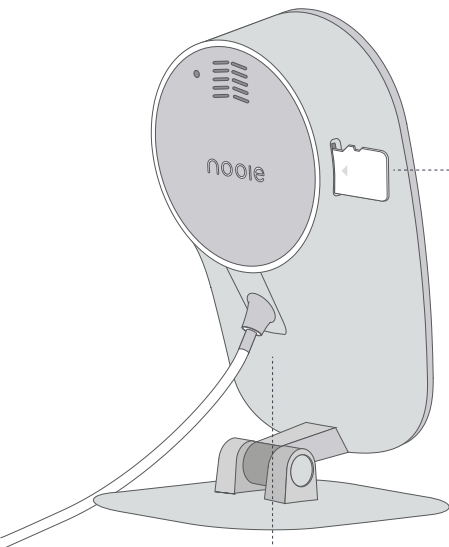

Micro SD slot

Power input

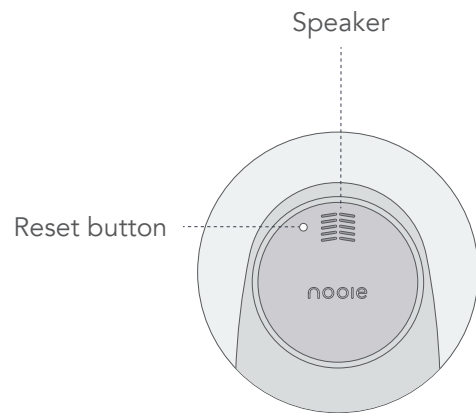

Speaker

Reset button

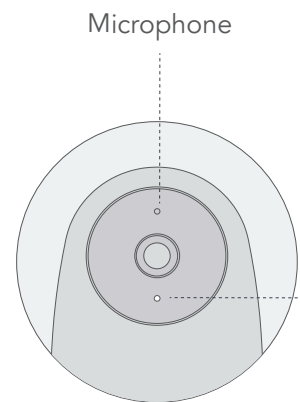

Microphone

Status light

Wall Mount

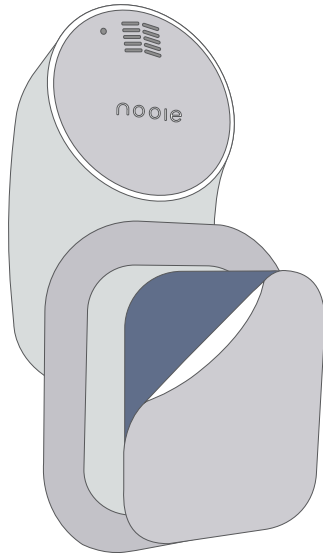

Place 3M double-sided sticker underneath the stand

Customer Care

Have more questions?

Check out the FAQ on our website!
www.nooie.com/support

Wanna share your feedback?

Tag us #nooie on social media!



Need other help?

Contact us at support@nooie.com

Warranty Terms





1. 30-day return policy & 2-year limited warranty.
2. Timely customer service via support@nooie.com.
3. Lifetime professional tech support provided by Nooie.

How to Set up

1. Download Nooie Cam App and create an account.
2. Connect the camera to a power outlet and wait for 15 seconds until red status light flashes.
3. Open the app and click "Add Camera" on front page.
4. Follow the instructions on the app, until you hear the sound prompt, enjoy the Nooie Cam!

Note: 5GHz network is not supported.

Light Indications





-  **Solid red light**
The device is powered on and initializing.
-  **Flashing red light**
The device is ready to connect.
-  **Flashing between white and red light**
Wi-Fi account or password is wrong, please reconnect.
-  **Flashing white light**
Connection is in progress.
-  **Solid white light**
The device is working properly.

Wie man es einstellt

1. Laden Sie die Nooie Cam App herunter und eröffnen Sie ein Benutzerkonto!
2. Verbinden Sie die Kamera mit einer Energiequelle und warten Sie 15 Sekunden, bis das rote Statuslicht aufblinkt!
3. Öffnen Sie die App und klicken Sie auf "Add Camera"/"Kamera hinzufügen" auf der ersten Seite.
4. Folgen Sie den Anweisungen in der App, bis Sie das Tonsignal hören, und genießen Sie die Nooie Cam!

Hinweis: 5-GHz-Netzwerk wird nicht unterstützt.

Leichte Hinweise





-  **Andauerndes rotes Licht**
Das Gerät ist eingeschaltet und wird gerade initialisiert.
-  **Blinkendes rotes Licht**
Das Gerät ist bereit, sich zu verbinden.
-  **Blinkt zwischen weißem, rotem Licht**
Wi-Fi Konto oder Passwort ist falsch, bitte verbinden Sie erneut.
-  **Blinkendes weißes Licht**
Das Gerät ist verbunden.
-  **Andauerndes weißes Licht**
Das Gerät funktioniert ordnungsgemäß.

Comment mettre en place

1. Téléchargez Nooie Cam App et créez un compte.
2. Connectez l'appareil photo à une prise de courant et attendez 15 secondes jusqu'à ce que le voyant d'état rouge clignote.
3. Ouvrez l'application et cliquez sur "Ajouter une caméra" sur la page d'accueil.
4. Suivez les instructions sur l'application, jusqu'à ce que vous entendiez le message sonore, et profitez de la caméra Nooie!

Remarque: le réseau 5 GHz n'est pas pris en charge.

Indications lumineuses





-  **Voyant rouge fixe**
L'appareil est sous tension et en cours d'initialisation.
-  **Voyant rouge clignotant**
L'appareil est prêt à se connecter.
-  **Voyant clignote entre blanche et rouge**
Le compte Wi-Fi ou le mot de passe est incorrect, veuillez reconnecter.
-  **Voyant blanche clignotante**
La connexion est en cours.
-  **Voyant blanche fixe**
L'appareil fonctionne correctement.

Come impostare

1. Scaricare il nostro app - Nooie Cam e poi creare un account.
2. Collegare la videocamera con il cavo di alimentazione e attendere 15 secondi finché l'indicatore LED rossa lampeggia.
3. Aprire l'app e cliccare "Add Camera" nella prima pagina.
4. Seguire le istruzioni sull'app, fino a quando sentirò il suono, e poi godere il nostro prodotto Nooie Cam!

Nota: la rete 5GHz non è supportata

Lo Stato dell'indicatore





-  **Indicatore Rossa Fissa**
Il dispositivo è acceso e in fase di inizializzazione.
-  **Indicatore Rossa Lampeggiante**
Il dispositivo è pronto per la connessione.
-  **Lampeggia tra luce bianca e rossa**
L'account Wi-Fi o la password sono sbagliati, ti preghiamo di riprovare.
-  **Indicatore Lampeggiante Bianco**
La connessione è in corso.
-  **Indicatore Bianco**
Il dispositivo funziona perfettamente.

Como instalarlo?

1. Descargue la aplicación Nooie Cam y cree una cuenta.
2. Conecte la cámara a una toma de corriente y espere 15 segundos hasta que la luz roja parpadee.
3. Abra la aplicación y haga clic en "Agregar cámara" en la página principal.
4. Siga las instrucciones en la aplicación, hasta que escuche el sonido y luego disfrute de Nooie Cam.

Nota: la red de 5GHz no es soporte.

Indicaciones de luz





-  Luz roja sólida
El dispositivo está encendido e inicializado.
-  Luz roja intermitente
El dispositivo está listo para conectarse.
-  Parpadeando entre la luz blanca y roja
Wi-Fi cuenta o contraseña es incorrecto, por favor vuelva a intentarlo.
-  Luz blanca intermitente
La conexión está en progreso.
-  Luz blanca sólida
El dispositivo funciona correctamente.

設定方法

1. Nooie Cam Appをダウンロードしてアカウントを作成します。
2. カメラを電源コンセントに接続、赤のステータスランプが点滅するまで15秒間待ちます。
3. アプリを開き、フロントページの「カメラの追加」をクリックしてください。
4. サウンドプロンプトが聞こえるまで、アプリの指示に従ってください。Nooie Camをお楽しみ。

ご注意:5GHz ネットワークまだ対応できません

ライトインジケータ

-  赤色ライト点灯
デバイスの電源が入っていて、初期化
-  赤色ライトの点滅
デバイスは接続準備
-  白いライトの点滅
接続中
-  白いライトと赤いライトで点滅
Wi-Fiアカウント又はパスワードがエラー再接続ください。
-  白いライトの点灯
デバイスは正常に動作



Website: www.nooie.com
Email: support@nooie.com

Designed in USA Made in China