

ENGLISH

# PROSCAN



MANUAL INSTRUCTION

PDVD6670

IMPORTANT  
READ THESE INSTRUCTIONS  
BEFORE USE AND RETAIN  
FOR FUTURE REFERENCE.



# SAFETY INFORMATION



TO REDUCE THE RISK OF FIRE AND ELECTRIC SHOCK, DO NOT EXPOSE THIS UNIT TO RAIN OR MOISTURE.



- This lightning flash with arrowhead symbol within an equilateral triangle is intended to alert the user to the presence of non-insulated "dangerous voltage" within the product's enclosure that may be of sufficient magnitude to constitute a risk of electric shock.
- Warning: To reduce the risk of electric shock, do not remove cover (or back) as there are no user-serviceable parts inside. Refer servicing to qualified personnel.
- The exclamation point within an equilateral triangle is intended to alert the user to the presence of important operating and maintenance instructions in the literature accompanying the appliance.

## IMPORTANT SAFETY INSTRUCTIONS

Read all instructions carefully, even if you are familiar with the appliance.

1. This appliance is not intended for use by children or infirm persons without supervision.
  2. Children should be prevented from playing with the appliance.
  3. INDOOR USE ONLY: this appliance is not intended for outdoor use.
  4. This appliance is not intended for use in bathrooms, laundry areas or similar moist locations. Never locate this appliance in the immediate surroundings of, or where it may fall into, a bath, basin, washtub, shower or swimming pool.
  5. Do not place naked flame sources, such as candles, on the appliance.
  6. Do not insert or allow foreign objects to enter any grille openings.
  7. Do not run the cord under carpeting. Instead, arrange the cord away from traffic areas where it will not become a trip hazard.
  8. To disconnect the appliance, turn the appliance off, switch off the power outlet and remove the plug from the power outlet.
  9. Do not misuse the cord. Never carry the appliance by the cord or pull to disconnect it from the outlet. Instead, grasp the plug and pull to disconnect.
  10. Read these instructions – All the safety and operating instructions should be read before this product is operated.
  11. Keep these instructions – The safety and operating instructions should be retained for future reference.
  12. Heed all warnings – All warnings on the appliance and in the operating instructions should be adhered to.
  13. Follow all instructions – All operating and use instructions should be followed.
  14. Do not use this apparatus near water – The appliance should not be used near water or moisture – for example, in a wet basement or near a swimming pool, and the like.
  15. Clean only with dry cloth.
  16. Do not block any ventilation openings. Install in accordance with the manufacture's instructions.
  17. Do not install near any heat sources such as radiators, heat registers, stoves, or other apparatus (including amplifiers) that produce heat.
  18. Do not defeat the safety purpose of the polarized or grounding plug. A polarized plug has two blades with one wider than the other. A grounding plug has two blades and a third grounding prong. The wide blade or the third prong is provided for your safety. If the provided plug does not fit into your outlet, consult an electrician for replacement of the obsolete outlet.
  19. Protect the power cord from being walked on or pinched particularly at the plugs, convenience receptacles, and at the point where they exit from the apparatus.
  20. Only use attachments/accessories specified by the manufacturer.
  21. se only with the cart, stand, tripod, bracket, or table specified by the manufacturer, or sold with the apparatus. When a cart or rack is used, use caution when moving the cart/apparatus combination to avoid injury from tip-over.
- 
22. Unplug the apparatus during lightning storms or when unused for long periods of time
  23. Refer all servicing to qualified personnel. Servicing is required when the apparatus has been damaged in any way, such as power supply cord or plug is damaged, liquid has been spilled or objects have fallen into the apparatus has been exposed to rain or moisture, does not operate normally, or has been dropped.
  24. CAUTION: These servicing instructions are for use by qualified service personnel only. To reduce the risk of electric shock, do not perform any servicing other than that contained in the operating instructions unless you are qualified to do so.
  25.  This equipment is a Class II or double insulated electrical appliance. It has been designed in such a way that it does not require a safety connection to electrical earth.
  26. WARNING: The battery (battery or batteries or battery pack) shall not be exposed to excessive heat such as sunshine, fire or the like.
  27. WARNING: The mains plug is used as disconnect device, the disconnect device shall remain readily operable.
  28.  Invisible laser radiation when open and interlocks defeated. Avoid exposure to beam of laser.
  29. WARNING: Only use attachments/accessories specified or provided by the manufacturer.
  30. WARNING: To reduce the risk of fire or electric shock, do not expose this apparatus to rain or moisture. The apparatus shall not be exposed to dripping or splashing and that objects filled with liquids, such as vases, shall not be placed on apparatus.
  31. No naked flame sources, such as lighted candles, should be placed on the apparatus.
  32. Attention should be drawn to environmental aspects of battery disposal.
  33. Use of the apparatus in moderate climates. Caution  
Do not open do not attempt to repair, disassemble or modify this appliance.  
Dangerous high voltages exist inside this appliance. This appliance is only to be serviced by Service Technician. There are no user-serviceable parts inside. Do not look at laser pick-up directly. Do not touch the lens.

# SAFETY INFORMATION

## Installation Warnings

**Ventilation** Slots and openings in the case are provided for ventilation to ensure reliable operation of the video product and to protect it from overheating. These openings must not be blocked or covered. The openings should never be blocked by placing the product on a bed, sofa, rug, or heat register. This product should not be placed in a built-in installation such as a bookcase or rack, unless proper ventilation is provided or the video product manufacturer instructions have been followed.

**Outdoor Antenna Grounding:** If an outside antenna or cable system is connected to the video product, be sure the antenna or cable system is grounded so as to provide some protection against voltage surges and buildup static charges. ANSI/NFPA No. 70-1984 provides information with respect to proper grounding of the mast and supporting structure, grounding of the lead-in wire to an antenna-discharge unit, connection to grounding electrodes, and requirements for the grounding electrode.

**Power Lines:** An outside antenna system should not be located in the vicinity of overhead power lines, other electric light or power circuits, or where it can fall into such power lines or circuits. When installing an outside antenna system, extreme care should be taken to keep from touching or approaching such power lines or circuits, as contact with them might be fatal. Installing an outdoor antenna can be hazardous and should be left to a professional antenna installer.

**Lightning:** For added protection for this product during a lightning storm, or when it is left unattended and unused for long periods of time, unplug it from the wall outlet and disconnect the antenna or cable system. This will prevent damage to the video product due to lightning and power line surges.

## Compulsory Warnings

If the supply cord is damaged, it must be replaced by service Technician, in order to avoid a hazard. This product has not been designed for any uses other than those specified in this booklet.

### Laser Safety

This compact disc player is classified as a CLASS 1 LASER PRODUCT.

Only qualified service personnel should remove the cover or attempt to service this device due to possible eye injury.

Invisible laser radiation when open and interlock failed or defeated.

Avoid direct exposure to beam.

**Warning:** Changes or modifications to this unit not expressly approved by the party responsible for compliance could void the user's authority to operate the equipment.

**NOTE:** This equipment has been tested and found to comply with the limits for a Class B digital device, pursuant to Part 15 of the FCC Rules. These limits are designed to provide reasonable protection against harmful interference in a residential installation. This equipment generates, uses and can radiate radio frequency energy and, if not installed and used in accordance with the instructions, may cause harmful interference to radio communications.

However, there is no guarantee that interference will not occur in a particular installation. If this equipment does cause harmful interference to radio or television reception, which can be determined by turning the equipment off and on, the user is encouraged to try to correct the interference by one or more of the following.

measures:

Reorient or relocate the receiving antenna.

Increase the separation between the equipment and receiver.

Connect the equipment into an outlet on a circuit different from that to which the receiver is connected.

Consult the dealer or an experienced radio/TV technician for help.

# INTRODUCTION

Loading batteries to the remote control

- Remove the battery compartment cover.
- Load two AAA (UM-4 or R03) batteries into the battery compartment.
- Make sure that the batteries have been inserted in the correct polarities matching to the symbols +, - marked in the battery compartment. Close the battery compartment cover.
- When replacing batteries, replace both batteries. Do not mix new and used batteries operating together, otherwise, the operation lifetime will be much shorter than normal.
- Remove the batteries if the unit will not be used for a prolonged period of time.

The remote control transmits a directional infrared beam. Be sure to aim the remote control directly at the infrared sensor of the unit during operation.

If the sensor has been covered or there is a large object between the remote control and the sensor, the sensor will not respond.

The sensor may be not able to receive the remote signal when it is exposed to direct sunlight or a strong artificial light (fluorescent or strobe light). In this case, change the direction of the light or reposition the unit to avoid direct lighting.

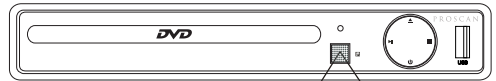
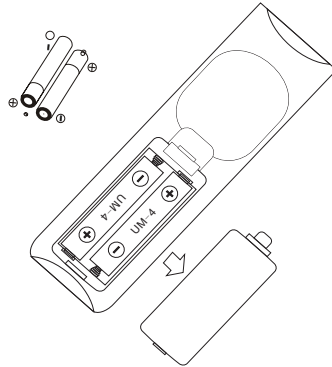

Within approximately  
6 meter (20 feet)





## BE ENVIRONMENTALLY FRIENDLY

Do not dispose of batteries as normal rubbish. Be environmentally friendly, dispose of batteries following the Government's regulation.

## About DVD

DVD (Digital Versatile Disc) is a digital video medium under the MPEG II format, featuring a variety of revolutionary entertainment capabilities. The MPEG II video compression technology provides capacity for an excellent picture of minimum 500 lines resolution on screen, up to 8 language soundtracks, up to 9 views from different camera angles and up to 32 language subtitles (provided the DVD disc itself supports these features).

### Disc information

Disc types	DVD	CD
Recording Method	Digital / MPEG II	Digital
Capacity	Single-layer / Single side 4.7GB = 2 hr Single-layer / Double sides 8.5GB = 4 hr Double-layers / Single side 9.4GB = 4.5 hr Double-layers / Double sides 17GB = 8 hr	650MB=74min
Disc size	12cm / 8cm	12cm / 8cm
Horizontal Resolution	500 lines up	-
Sub-titles	32	-
Sound tracks	8	1
Symbol		

### REMARK

Some features contained in this DVD player are related to the DVD disc's software.

Some features cannot be performed if the disc does not support the feature, or requires special settings.

Check the features printed on the disc's packing or follow the instructions of the Disc's on screen menu.



The region code of the player is region 1.

### Select a DVD disc

#### DVD Region Code

DVD discs and DVD players are manufactured under the worldwide agreed DVD Regional Code System that the player will operate only with corresponding disc of the same Regional Code.

Region code	Region
1	Canada, USA
2	Europe (incl. Poland, Romania, The Czech republic), Japan, Middle East (incl. Saudi Arabia, Egypt, Iran, South Africa)
3	East Asia (incl. Hong Kong, Taiwan, South Korea), South-East Asia
4	Australia, Caribbean, Central & South America, Mexico, New Zealand
5	Africa, Former Soviet Union, India, North Korea, Pakistan, Turkmenistan
6	China

### Care of disc

Video disc contains high-density compressed data that needs proper handling

- Hold the disc with fingers. Hold the disc's outer edge and/or the center spindle hole. Do not touch the disc surface.

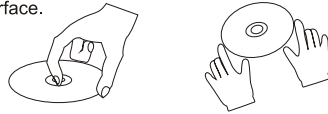

- Do not bend or press the disc. Do NOT expose the disc to direct sunlight or heating sources.



- Store discs in cabinet vertically, in dry condition. Prevent exposure to:
  - Direct sunlight
  - Heat or exhaust from a heating device.
  - Extreme humidity
- Clean the disc surface with a soft, dry cleaning cloth. Wipe the disc surface gently, radially, from center toward the outer edge.
- Do not apply thinner, alcohol chemical solvent, or sprays when cleaning. Such cleaning fluids will permanently damage the disc surface.

## About the player

Front panel

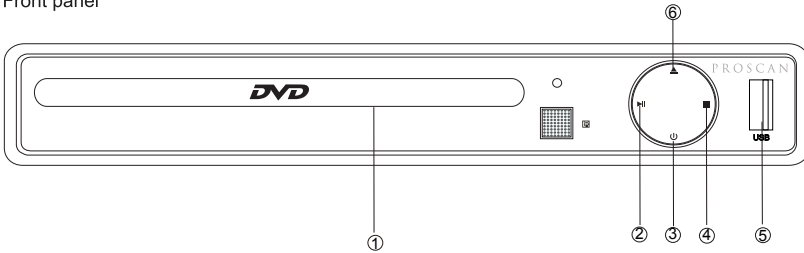

- |              |         |              |
|--------------|---------|--------------|
| ① DVD DOOR   | ③ POWER | ⑤ USB        |
| ② PLAY/PAUSE | ④ STOP  | ⑥ OPEN/CLOSE |

Back panel

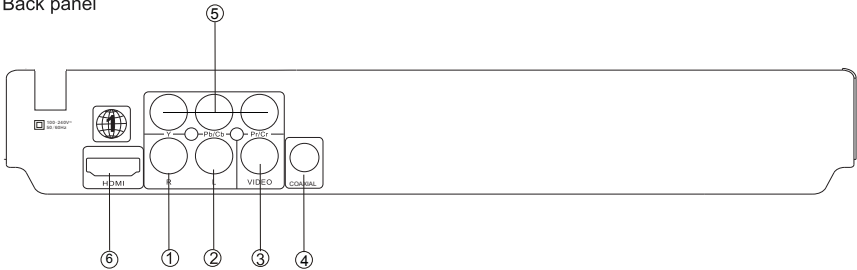

- |                                 |                                 |
|---------------------------------|---------------------------------|
| ① RIGHT output jack             | ⑤ Component YUV(Y.Cb.Cr) output |
| ② LEFT output jack              | ⑥ HDMI output jack              |
| ③ Video output                  |                                 |
| ④ Coaxial digital signal output |                                 |

Remote control

Some features of the player can only be performed by the remote control.  
 Some features described in this owner's manual are related to the Disc's encoding.  
 Some features may not be available, if the disc encoding does not support the feature.

REMARK

Some features contained in this DVD player are related to the DVD Disc's software.  
 Some features cannot be performed if the disc does not support the feature, or requires special settings.  
 Check the features printed on the disc's packing or follow the instructions of the Disc's on screen menu.

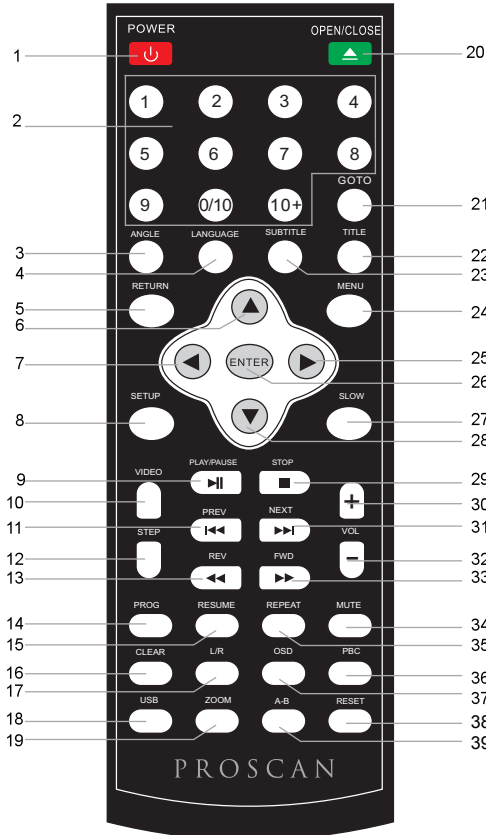

- |                 |                |
|-----------------|----------------|
| 1. POWER        | 20. OPEN/CLOSE |
| 2. 0-10+ NUMBER | 21. GOTO       |
| 3. ANGLE        | 22. TITLE      |
| 4. LANGUAGE     | 23. SUBTITLE   |
| 5. RETURN       | 24. MENU       |
| 6. UP           | 25. RIGHT      |
| 7. LEFT         | 26. ENTER      |
| 8. SETUP        | 27. SLOW       |
| 9. PLAY/PAUSE   | 28. DOWN       |
| 10. VIDEO       | 29. STOP       |
| 11. PREV        | 30. VOL+       |
| 12. STEP        | 31. NEXT       |
| 13. REV         | 32. VOL-       |
| 14. PROG        | 33. FWD        |
| 15. RESUME      | 34. MUTE       |
| 16. CLEAR       | 35. REPEAT     |
| 17. L/R         | 36. PBC        |
| 18. USB         | 37. OSD        |
| 19. ZOOM        | 38. RESET      |
|                 | 39. A-B        |

Notes

The remote control transmits a directional infrared beam. Be sure to aim the remote control directly at the infrared sensor during operation. When the sensor is covered or there is a large object between the remote control and the sensor, the sensor cannot receive signals. The sensor may not be able to receive signals properly when it is exposed to direct sunlight or a strong artificial light (such as a fluorescent or strobe light). In this case, change the direction of the light or reposition the unit to avoid direct lighting.

# SYSTEM CONNECTION

## Preparations

### Accessories

1. Remote control
2. Audio/Video cable
3. User's manual

(check whether be fully equipped after open the box)

### Battery installation of remote controller (Batteries not included)

Place two AAA batteries not supplied into the battery compartment. Be sure the polarities are correct. There should be no large obstacles between the remote controller and the main unit.

### System connection(Optional according to your back panel)

1. When making connection between this unit and other components, be sure all connection with power-off.
2. Audio/Video cables are connected according to the different colour identification and they should be fitted firmly.
  - Yellow to video terminal
  - White to audio terminal L,
  - Red to audio terminal R,



# OSD SETUP

This player allows you to customise the performance to your personal preferences.



Displaying the setup menu screen  
The setup preferences.



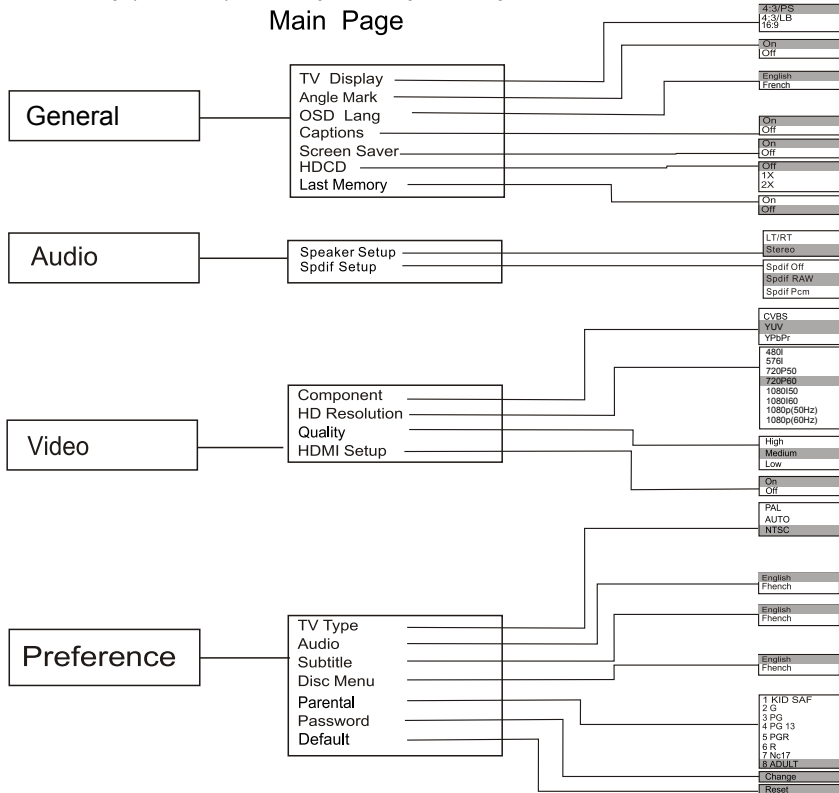











The selected category will provide you the setting details using the following screen.



Set on "PARENTAL " and press "PARENTAL" and choose the desired rating. Then input the code "8888" and enter it, the desired rating you choosed is effective.

The original factory code is "8888". If you want to change the code, Set on "password" and press "change". Input the old password "8888", then input the new code and confirm.

# REMOTE CONTROL OPERATION

- 
    - During playback, press **POWER** to stop the player and close the power.
  - 
    - To open the disc tray, press **OPEN/CLOSE**  
To close the disc tray, press **OPEN/CLOSE** again.
  - 
    - During DVD playback, press **TITLE** to display the DVD title menu or play the first title.  
Note: this function is subject to the disc.
  - 
    - During DVD playback, press **MENU** to display the disc menu of the current title.  
Note: This function is subject to the disc
  - 
    - During VCD/DVD playback, press **OSD** to display the current time counter position as follows.
- |  |  |
|--|--|
| <p>VCD 2.0</p> <p>Time_ _ : _ : _ / _ : _ : _</p> <p style="text-align: center;">↓                      ↓</p> <p style="text-align: center;">Elapsed time    Left time for the current track</p> | <p>DVD VIDEO</p> <p>Time_ _ : _ : _ / _ : _ : _</p> <p style="text-align: center;">↓                      ↓</p> <p style="text-align: center;">Elapsed time    Left time for the current track</p> |
|--|--|
- 
    - During VCD/SVCD playback, Press **PBC** to select the mode of **PBC On** or **PBC Off**  
**PBC** is: playback control used to navigate VCD/SVCD.
  - 
    - These keys are used to input the time, as well as title, chapter and track numbers
    - When a CD,DVD or VCD is playing (with **PBC** off), press the 0-10 keys to select a track directly.
    - When a numeric item is displayed on the screen, press the 0-10 keys to select the desired entry.
    - Press **10+** button two times and **0/10** button once for **20**
  - 
    - During AVI,DVD, VCD or SVCD playback, press **SLOW** for slow motion playback.
    - Once you press **SLOW**, the disc will play at 1/2, 1/4, 1/8 and 1/16 normal speed.
    - Press **PLAY** to resume normal playback.
  - 
    - During AVI,DVD, CD or VCD playback, press **PREV** to play the previous chapter,title or track.
  - 
    - During AVI,DVD, CD or VCD playback, press **NEXT** to play the next chapter, title or track.
  - 
    - Each press of the **REPEAT** button will change the repeat mode.  
During VCD,CD playback,there are three modes: repeat track, repeat All and Off.  
During AVI/DVD,playback,there are three modes: repeat chapter, repeat title, repeat all and Off.  
Note:During VCD playback,the **PBC** mode must be set to Off
  - 
    - During playback, press **A-B** to select point **A**
    - Press it again to select point **B**. The player will repeat the section from **A** to **B** automatically.
    - Press **A-B** a third time to cancel **A-B** repeat and clear points **A** and **B**.  
Note: During AVI/CD/VCD/SVCD playback, points **A** and **B** must be within the same track.  
During AVI/DVD playback, points **A** and **B** can be selected from different chapters.
  - 
    - During AVI/DVD, CD or VCD playback, press **REV** To in reverse.  
the disc at 2, 4, 8, 16 and 32 times speed
    - Press **PLAY** to resume normal playback.
  - 
    - During AVI/DVD, CD or VCD playback, press **FWD** to forward. The disc at 2, 4, 8, 16 and 32 times speed.
    - Press **PLAY** to resume normal playback.
  - 
    - Press **RAN** play disc randomly

# REMOTE CONTROL OPERATION

## MUTE

Press MUTE to turn off the audio.  
Press MUTE again to resume normal sound.

## R/L

During VCD/SVCD playback, press R/L repeatedly to select the channel of audio-output: Left / Right / Mix / Stereo.

## CLEAR

Press CLEAR to delete the numbers you have entered when programming.

## PAUSE / PLAY

To pause playback, press PAUSE / PLAY.  
To start playing, press PAUSE / PLAY again.

## STOP

Press STOP once during playback to stop and hold playback.  
Press PLAY to resume playback from the point you have pressed STOP.  
Press STOP twice to stop playback completely.

## RETURN

When the PBC is on, press return, and you can select once again from the menu displaying.  
This function is only available to VCD.

## ZOOM

During VCD/SVCD/DVD/AVI playback, press ZOOM to magnify the image

as follows:

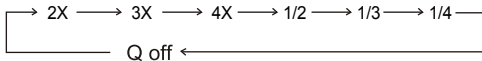

## STEP

When playing AVI/DVD,VCD,SVCD disc, press STEP once, the picture changes to next frame, Press PLAY to resume normal play.

## SETUP

Press the SETUP button on your remote control to access the setup menu. The setup menu is a Multi-level Menu.

Use the ▼ or ▲ buttons to select the menu option that you need.

Use the ◀ and ▶ to go back to previous level menu or to enter the next level menu.

Press ENTER button to confirm selection.

Press SETUP button to exit setup.

# REMOTE CONTROL OPERATION

## VOL

Press VOL + to increase the volume.  
Press VOL - to reduce the volume.

## ANGLE

During DVD playback,  
Press ANGLE to view scenes from different camera angles.  
Press ANGLE repeatedly to change from one camera angle to another.  
Note: This function is disc specific.

## SUBTITLE

During DVD playback,  
Press SUBTITLE repeatedly to select from up to 32 subtitle languages.  
Note: This function is disc specific (language will vary).

## LANGUAGE

Press LANGUAGE repeatedly to select from up to 8 languages/formats during DVD playback.  
Press repeatedly to select from up to 4 languages/formats during SVCD playback.

## GOTO

DVD disc

Press GOTO to select CHAPTER, TITLE or TIME, and you need to press it several times to switch CHAPTER, TITLE or TIME, when you insert number key, it will turn to desired item.

VCD disc

Press GOTO to select TRACK, TIME or DISC TIME, and you need to press it several times to switch TRACK, TIME or DISC TIME, when you insert number key, it will turn to desired item.

## PROG

Press PROG to get program menu when reading DVD & VCD, then program your wanted songs. (DVD programme needs TITLE and MENU.)

## HDMI function

1. Connect HDMI cable to HDMI output of the rear panel of DVD player and TV.
2. Set TV mode to 'HDMI' mode
3. Press 'setup' button on remote control, in system setup/HD output, please choose the HDMI mode (480P, 576P, 720P, 1080i, 1080P) you want.

Note: This DVD Player is set up for HDMI Connection, with connection to the TV via an HDMI cable (not supplied) connecting the HDMI socket on your TV and on the DVD player.

## USB

Connecting a USB device

- 1) power-on the unit.
- 2) when no disc, insert a USB key inside the connector, the unit can read USB automatically.
- 3) when watching DVD programme, pls press STOP button firstly then press USB button to switch the input source between DISC and USB.

# TROUBLE SHOOTING

Should your DVD player develop a problem, please check below before requesting service:

Symptom	Check and Action
No Power	<ul style="list-style-type: none"> <li>• Check if the power cord has been properly connected to the power outlet.</li> <li>• Check if the main power has been switched on.</li> </ul>
Does not play	<ul style="list-style-type: none"> <li>• No disc, load a disc.</li> <li>• Disc has been loaded upside down. Place the disc with the label side up.</li> <li>• Disc's region code does not match to the player.</li> <li>• Disc is not correct type for player.</li> <li>• Disc is damaged or dirty, clean the disc or try another disc.</li> <li>• Moisture may be condensed inside the player. Remove the disc and leave the unit power on for one or two hours.</li> </ul>
No Picture	<ul style="list-style-type: none"> <li>• Check if the TV set has power on, use TV remote to select A/V signal for DVD rather than broadcast.</li> <li>• Check if the system connection is proper and secure.</li> <li>• Check if the connection cables are damaged.</li> <li>• Clean the disc.</li> </ul>
Picture noise / distorted	<ul style="list-style-type: none"> <li>• The disc is dirty or damaged. Clean the disc or try another disc.</li> <li>• Reset the color system of the player or the TV set.</li> <li>• Try to direct the player to the TV set instead of via other components, such as a VCR.</li> </ul>
Picture not full screen	<ul style="list-style-type: none"> <li>• Select the screen format from the player's SETUP MENU, see "SETUP MENU " of this manual.</li> <li>• Select the screen format from DVD disc menu.</li> </ul>
Malfunction	<ul style="list-style-type: none"> <li>• Should the player develop a malfunction, unplug the player for 30 minutes. After 30 minutes, power on the player and the restore function should reset the player.</li> </ul>



**CAUTION** : To reduce the risk of fire and electric shock, do not remove the cover (or back) of the unit. Refer servicing only to Singer Service Technician

Symptom	Check and Action
Cannot SKIP or SEARCH	<ul style="list-style-type: none"> <li>Some discs are programmed that do not allow users to SKIP or SEARCH at some sections, especially at the beginning WARNING section.</li> <li>Single Chapter disc cannot apply SKIP function.</li> </ul>
No sound or sound output not complete	<ul style="list-style-type: none"> <li>Check if the TV and Amplifier have been switched on, and correctly set.</li> <li>Check if the TV and Amplifier system connection is secured.</li> <li>Press LANGUAGE button to select other audio tracks output of disc.</li> <li>Check if the MUTE function of the TV or Amplifier has been activated.</li> <li>There will be no sound output during P AUSE / STEP / SLOW and SEARCH.</li> </ul>
MP3 disc no sound or noisy	<ul style="list-style-type: none"> <li>When PC program files or other data files are mixed with MP3 files in the same disc, the player may play the non-MP3 files with noise or no sound.</li> <li>Check the disc, if all the files on disc are MP3 files Skip the file, try other files.</li> </ul>
Remote control does not function	<ul style="list-style-type: none"> <li>Remove the obstacles between the remote control and the player .</li> <li>Point the remote control towards the remote sensor on the player.</li> <li>Check if the batteries of the remote control have been loaded with correct polarities.</li> <li>Replace the batteries of the remote control.</li> </ul>

# SPECIFICATIONS

Type of Disc	DVD CD-DA CD-MP3 Kodak Picture CD CD-R / CD-RW
Video Format	MPEG 2
Audio Format	MPEG 1, LAYER 1, LAYER 2, LAYER 3
Signal Output	Color System: NTSC Audio System: DIGITAL down mix stereo DIGITAL digital output Audio DAC 16bit/48KHz  Video Output: 1 Vpp (at 75 ohm) Audio Output (Stereo): 2 Vpp
Frequency Response	CD: 4Hz 20KHz (EIAJ) DVD: 4Hz 22KHz (48K) 4Hz 44KHz (96K)
S/N ratio	> 92 dB
THD	< 0.04%
Output Terminals	Video (composite) output X1 2.0CH output X1 Component YUV(Y.Cb.Cr) output X1 Coaxial digital signal output X1 HDMI output X1
Power Supply	AC 100-240V~ 50/60Hz
Dimensions	DVD size : W225xD200xH48mm