



at&t

User's manual

CL80113

DECT 6.0 expansion handset

for use with AT&T models

CL81113/CL81213/CL81313/

CL82113/CL82213/CL82263/

CL82313/CL82363/CL82413/

CL82463/CL82513/CL83113/

CL83213/CL83263/CL83313/

CL83363/CL83413/CL83463



Congratulations

on your purchase of this AT&T product. Before using this AT&T product, please read the **Important safety information** section on pages 20-22 of this manual. For complete instructions, please refer to the manual provided with your CL81113/CL81213/CL81313/CL82113/CL82213/CL82263/CL82313/CL82363/CL82413/CL82463/CL82513/CL83113/CL83213/CL83263/CL83313/CL83363/CL83413/CL83463 telephone. You can also visit our website at **www.telephones.att.com** or call

1 (800) 222-3111. In Canada, dial **1 (866) 288-4268**.

This telephone meets the California Energy Commission regulations for energy consumption. Your telephone is set up to comply with the energy-conserving standards right out of the box. No further action is necessary.

Model number: CL80113

Type: DECT 6.0 expansion handset

Serial number: _____

Purchase date: _____

Place of purchase: _____

Both the model and serial numbers of your AT&T product can be found on the bottom of the telephone base.

Save your sales receipt and original packaging in case it is necessary to return your telephone for warranty service.



Telephones identified with this logo have reduced noise and interference when used with most T-coil equipped hearing aids and cochlear implants. The TIA-1083 Compliant Logo is a trademark of the Telecommunications Industry Association. Used under license.



The ENERGY STAR® program (www.energystar.gov) recognizes and encourages the use of products that save energy and help protect our environment. We are proud to supply this product with an ENERGY STAR® qualified power adapter meeting the latest energy efficiency guidelines.

User's manual

CL80113

DECT 6.0 expansion handset

for use with AT&T models

CL81113/CL81213/CL81313/CL82113/

CL82213/CL82263/CL82313/CL82363/

CL82413/CL82463/CL82513/CL83113/

CL83213/CL83263/CL83313/CL83363/

CL83413/CL83463



Table of contents

Getting started

Installation.....	1
Quick reference guide - handset.....	2
Charger installation.....	5
Battery installation and charging.....	6

Registration and deregistration

Adding and registering handsets	8
Register a handset to your telephone base	8
Deregistering handsets	10
Deregister all handsets from your telephone base	10

Appendix

Troubleshooting	11
Maintenance.....	19
Important safety information	20
Safety information.....	20
Especially about cordless telephones.....	21
Precautions for users of implanted cardiac pacemakers	22
Pacemaker patients.....	22
ECO mode.....	22
Especially about telephone answering systems	22
FCC Part 68 and ACTA.....	23
FCC Part 15.....	25
California Energy Commission battery charging testing instructions.....	26
Limited warranty.....	27
Technical specifications	30
DECT 6.0 digital technology.....	30
Telephone operating range.....	30
Redefining long range coverage and clarity.....	30
HD audio.....	30

You must install and charge the battery before using the telephone.



STOP!

See pages 6-7 for easy instructions.

Your product may be shipped with a protective sticker covering the handset display - remove it before use.

For customer service or product information, visit our website at **www.telephones.att.com** or call **1 (800) 222-3111**.
In Canada, dial **1 (866) 288-4268**.

Avoid placing the telephone base too close to:

- Communication devices such as television sets, VCRs, or other cordless telephones.
- Excessive heat sources.
- Noise sources such as a window with traffic outside, motors, microwave ovens, refrigerators, or fluorescent lighting.
- Excessive dust sources such as a workshop or garage.
- Excessive moisture.
- Extremely low temperature.
- Mechanical vibration or shock such as on top of a washing machine or workbench.

Quick reference guide - handset

CHARGE light

On when the handset is charging in the telephone base or charger.

▼CID/VOLUME

- Press ▼CID to show caller ID history when the handset is not in use.
- Press to scroll down while in menus.
- While entering names or numbers, press to move the cursor to the left.
- Press to decrease the listening volume when on a call.
- Press to decrease the message playback volume (for models with built-in answering system only).

REDIAL/PAUSE

- Press repeatedly to view the last ten numbers dialed.
- While entering numbers, press and hold to insert a dialing pause.

PHONE/FLASH

- Press to make or answer a call.
- During a call, press to answer an incoming call when you receive a call waiting alert.

1

- Press and hold to set or to dial your voicemail number.

TONE*/a>A

- Press to switch to tone dialing temporarily during a call if you have pulse service.
- While entering names, press to change the next letter to upper or lower case.

)/SPEAKER

- Press to make or answer a call using the speakerphone.



Quick reference guide - handset

▲DIR/VOLUME

- Press ▲DIR to show directory entries when the handset is not in use.
- Press to scroll up while in menus.
- While entering names or numbers, press to move the cursor to the right.
- Press to increase the listening volume when on a call.
- Press to increase the message playback volume (for models with built-in answering system only).

MENU/SELECT

- When the handset is not in use, press to show the menu.
- While in the menu, press to select an item or save an entry or setting.

OFF/CANCEL

- During a call, press to hang up.
- While in a menu, press to cancel an operation, back up to the previous menu, or exit the menu display, or press and hold this button to exit to idle mode.
- Press and hold while the telephone is not in use to erase the missed call indicator.

QUIET# (pound key)

- Press and hold to enter the **QUIET** mode setting screen, or to deactivate **QUIET** mode.

MUTE/DELETE

- During a call, press to mute the microphone.
- While reviewing the caller ID log, the directory or the redial memory, press to delete an individual entry.
- While predialing, press to delete digits.

EQ

During an outside call, intercom call, message or announcement playback, press to change the audio quality to best suit your hearing.



Quick reference guide - handset

Handset side view

PUSH TO TALK



- Press to initiate a one-to-one or one-to-group broadcast.
- Press and hold to broadcast to a group of system devices.

Main menu

The > symbol highlights a menu item.

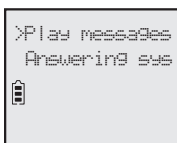

Main menu

- Play messages
 - Answering sys
 - Directory
 - Caller ID log
 - Intercom
 - Ringers
 - Set date/time
 - Settings
 - Web address
- Only on models with answering systems

Using menus:

- Press **MENU/SELECT** to show the menu.
- Press **▼CID** or **▲DIR** to scroll through menu items.
- Press **MENU/SELECT** to confirm or save changes to a highlighted menu item.
- Press **OFF/CANCEL** to cancel an operation, back up to the previous menu, or exit the menu display.

For complete instructions, refer to the manual provided with your CL81113/CL81213/CL81313/CL82113/CL82213/CL82263/CL82313/CL82363/CL82413/CL82463/CL82513/CL83113/CL83213/CL83263/CL83313/CL83363/CL83413/CL83463 telephone system. If you are unable to find your manual, go to www.telephones.att.com/manuals to read and/or download the manual.

Charger installation

Install the charger as shown below.

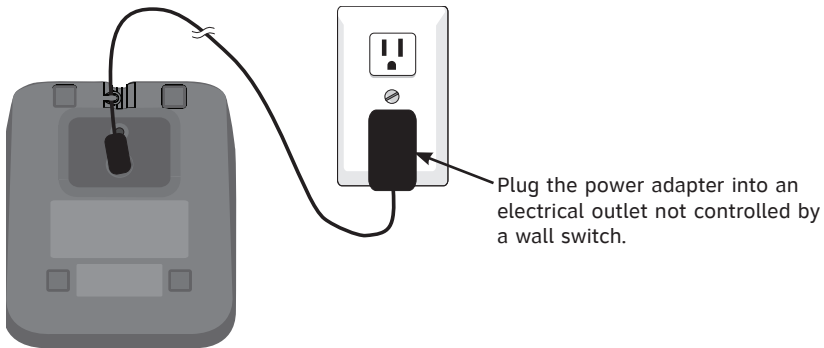



IMPORTANT INFORMATION

1. Use only the power adapter supplied with this product. To order a replacement power adapter, visit our website at **www.telephones.att.com** or call **1 (800) 222-3111**. In Canada, dial **1 (866) 288-4268**.
2. The power adapter is intended to be correctly oriented in a vertical or floor mount position. The prongs are not designed to hold the plug in place if it is plugged into a ceiling, under-the-table or cabinet outlet.

Battery installation and charging

Install the battery as shown on page 7. Once you have installed the battery, the screen indicates the battery status (see the table below). If necessary, place the handset in the telephone base or charger to charge the battery. For best performance, keep the handset in the telephone base or charger when not in use. The battery is fully charged after ten hours of continuous charging. See the table on page 30 for battery operating times.

If the screen shows **Place in charger** and  flashes, you need to charge the handset without interruption for at least 30 minutes to give the handset enough charge to use the telephone for a short time. The following table summarizes the battery charge indicators and actions to take.

Battery indicators	Battery status	Action
The screen is blank, or shows Place in charger and  (flashing).	Battery has no or very little charge. The handset cannot be used.	Charge without interruption (at least 30 minutes).
The screen shows Low battery and  (flashing).	Battery has enough charge to be used for a short time.	Charge without interruption (at least 30 minutes).
The screen shows HANDSET X .	Battery is charged.	To keep the battery charged, place it in the telephone base or charger when not in use.



NOTE: If you are on a phone call in low battery mode, you hear four short beeps every minute.

Battery installation and charging



Step 1

Plug the battery connector securely into the socket inside the handset battery compartment. Insert the supplied battery with the label **THIS SIDE UP** facing up as indicated.



Step 2

Align the cover flat against the battery compartment, then slide it upwards until it clicks into place.



CHARGE light

Step 3

Charge the handset by placing it face forward in the telephone base or charger. The **CHARGE** light on the handset is on during charging.

After you install your telephone or power returns following a power outage, the handset will prompt you to set the date and time. For instructions, see **Set date/time** in the telephone system's user's manual for details. To skip setting the date and time, press **OFF/CANCEL**.

IMPORTANT INFORMATION

1. Use only the supplied rechargeable battery or replacement battery (model BT183342). To order, visit our website at **www.telephones.att.com** or call **1 (800) 222-3111**. In Canada, dial **1 (866) 288-4268**.
2. If you do not use the handset for a long time, disconnect and remove the battery to prevent possible leakage.

Adding and registering handsets

Before using a new CL80113 handset, you must register it with the AT&T CL81113/CL81213/CL81313/CL82113/CL82213/CL82263/CL82313/CL82363/CL82413/CL82463/CL82513/CL83113/CL83213/CL83263/CL83313/CL83363/CL83413/CL83463 telephone system (purchased separately). The telephone system can support up to 12 handsets.

The handsets provided with your telephone system are already registered as **HANDSET 1** and so forth. Additional handsets registered to the telephone system are assigned in sequential order they are registered (up to **HANDSET 12**).

You must register each handset separately. When first purchased, all expansion handsets show **To register HS, see manual**.

Register a handset to your telephone base

1. Before you begin registration, make sure the handset is out of the telephone base or charger and shows **To register HS, see manual**.
2. Put the handset you wish to register on the telephone base cradle.

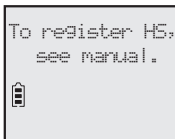

For registration, put the handset on the telephone base, not the handset charger.

Adding and registering handsets

3. The screen shows **Registering... Please wait** and the **IN USE** light on the telephone base turns on. If the registration is successful, **HANDSET X Registered** appears on the screen (**HANDSET** represents the handset name, **X** represents the handset number). The handset beeps and the **IN USE** light turns off. The handset is now registered with the telephone base.



If registration fails, the system will automatically try to register again. If registration fails after the third try, **Registration failed** appears on the screen for a few seconds. This may take up to five minutes to occur. Please start again from Step 1 on the previous page.



NOTES:

- You cannot register a handset if any other system handset is in use.
- To reset the telephone, unplug the power from the telephone base and the battery from the handset, then plug them back in.

Deregistering handsets

You may need to deregister your handsets if:

- You have 12 registered handsets and need to replace a handset.



-OR-

- You wish to change the designated handset number of your registered handsets.

You must first deregister ALL the handsets, and then register each handset you wish to use again, one at a time.

Please read carefully through all the instructions on this page before beginning the deregistration process.

Deregister all handsets from your telephone base

1. Make sure that all handsets are out of the telephone base and chargers before you begin deregistration.
2. Press and hold  /**HANDSET LOCATOR** on the telephone base for about ten seconds (until the **IN USE** light starts to flash). The telephone base screen shows **Registering... Please wait** for five seconds, then it shows **Deregister all devices?** Release  /**HANDSET LOCATOR**.
3. Immediately press  /**HANDSET LOCATOR** again while the **IN USE** light is still flashing. (If the light stops flashing, start again with Step 1 above.)
4. It takes up to ten seconds to complete deregistration. Before registering the handset again, wait for the cordless handset screen to display **To register HS, see manual**.
5. To register the handset(s) to the telephone base again, follow the instructions on pages 8-9.



NOTES:

- If the deregistration process is not successful, you might need to reset the system and try again. To reset, unplug the power from the telephone base and plug it back in.
- You cannot deregister the handset(s) if any other system handset is in use.
- Even if the battery is depleted, you can still deregister the handset by following the steps above. After the handset is charged for at least ten minutes, the screen shows **To register HS, see manual**.

Troubleshooting

If you have difficulty with your phone, please try the suggestions below. For Customer Service, visit our website at

www.telephones.att.com or call **1 (800) 222-3111**.

In Canada, dial **1 (866) 288-4268**.

The handset registration is unsuccessful.

- Follow the handset registration instructions to register the handset again (see **Adding and registering handsets** on pages 8-9).

My telephone doesn't work at all.

- Make sure the power cord is securely plugged in.
- Make sure you plug the battery connector securely into the cordless handset.
- Make sure you plug the telephone line cord securely and firmly into the telephone base and the telephone wall jack.
- Charge the battery in the cordless handset for at least 10 hours. For optimum daily performance, return the cordless handset to the telephone base or charger when not in use.
- If the battery is depleted, it might take approximately 30 minutes to charge the handset before it shows **Low battery**. See page 6 for details.
- Reset the telephone base. Unplug the electrical power. Wait for approximately 15 seconds, then plug it back in. Allow up to one minute for the cordless handset and telephone base to reset.
- You may need to purchase a new battery. Refer to **Battery installation and charging** in this user's manual on pages 6-7.

I cannot get a dial tone.

- Try all the suggestions above.
- Move the cordless handset closer to the telephone base. You might have moved out of range.
- If the previous suggestions do not work, disconnect the telephone line cord from your telephone and connect the telephone line cord to another telephone. If there is no dial tone on that other telephone either, then
 - the telephone line cord may be defective: try installing a new telephone line cord.

Troubleshooting

If changing the telephone line cord does not help, the wall jack (or the wiring to this wall jack) may be defective.

- try using a different wall jack in your home to connect your CL81113/CL81213/CL81313/CL82113/CL82213/CL82263/CL82313/CL82363/CL82413/CL82463/CL82513/CL83113/CL83213/CL83263/CL83313/CL83363/CL83413/CL83463 telephone, or
- contact your telephone service provider (charges may apply).

I cannot dial out.

- Try all the suggestions above.
- Make sure you have a dial tone before dialing. The cordless handset might take a second or two to find the telephone base and produce a dial tone. This is normal. Wait an extra second before dialing.
- Eliminate any background noise. Noise from a television, radio or other appliances might cause the phone to not dial out properly. If you cannot eliminate the background noise, try muting the cordless handset before dialing, or dialing from another room with less background noise.
- If other phones in your home are having the same problem, contact your telephone service provider (charges might apply).

My cordless handset isn't performing normally.

- Make sure you plug the power cord securely into the telephone base. Plug the power adapter into a different, working electrical outlet without a wall switch.
- Move the cordless handset closer to the telephone base. You might have moved out of range.
- Reset the telephone base. Unplug the electrical power. Wait for 15 seconds then plug it back in. Allow up to one minute for the cordless handset and telephone base to reset.
- Other electronic products such as HAM radios and other DECT phones can cause interference with your cordless phone. Try installing your phone as far away as possible from these types of electronic devices.

Troubleshooting

Out of range OR No pwr at base appears on my cordless handset.

- Ensure you plug the telephone base in properly and the power is on.
- Place the cordless handset in the telephone base for one minute to allow the cordless handset and base to synchronize.
- Move the cordless handset closer to the telephone base. You might have moved out of range.
- Reset the telephone base. Unplug the electrical power. Wait for 15 seconds then plug it back in. Allow up to one minute for the cordless handset and telephone base to reset.
- Other electronic products such as HAM radios and other DECT phones can cause interference with your cordless phone. Try installing your phone as far away as possible from these types of electronic devices.

The batteries do not hold a charge.

- If the cordless handset is in the telephone base or charger and the charge light is not on, refer to **The charge light is off** (page 18) in this **Troubleshooting** guide.
- Charge the battery in the cordless handset for at least 10 hours. For optimum daily performance, return the cordless handset to the telephone base or charger when not in use.
- If the battery is depleted, it might take approximately 30 minutes to charge the handset before it shows **Low battery**. Refer to the table on page 6 for details.
- You might need to purchase a new battery. Refer to **Battery installation and charging** in this user's manual on pages 6-7.

I hear other calls while using my phone.

- Disconnect the telephone base from the telephone jack, and plug in a different telephone. If you still hear other calls, call your telephone service provider.

Troubleshooting

I get noise, static, or weak signals even when I'm near the telephone base.

- If you subscribe to high-speed Internet service (DSL - digital subscriber line) through your telephone line, you must install a DSL filter between the telephone line cord and the telephone wall jack. The filter prevents noise and caller ID problems as a result of DSL interference. Please contact your DSL service provider for more information about DSL filters.
- You may be able to improve the performance of your cordless phone by installing your new telephone base as far as possible from any other existing cordless telephone system that may already be installed.
- Other electronic products such as HAM radios and other DECT phones can cause interference with your cordless phone. Try installing your phone as far away as possible from these types of electronic devices.
- Do not install this phone near a microwave oven or on the same electrical outlet. You might experience decreased performance while the microwave oven is operating.
- If you plug your phone in with a modem or a surge protector, plug the phone (or modem/surge protector) into a different location. If this does not solve the problem, relocate your phone or modem farther apart from one another, or use a different surge protector.
- Move your phone to a higher location. The phone might have better reception in a high area.
- If the other phones in your home are having the same problem, contact your telephone service provider (charges may apply).

I experience poor sound quality when using the speakerphone.

- For increased sound quality while using the speakerphone, place the handset on a flat surface with the dialing keys facing up.

Troubleshooting

My cordless handset does not ring when I receive a call.

- Make sure that the ringer is not off. Refer to **Ringer volume** in the user's manual provided with your CL81113/CL81213/CL81313/CL82113/CL82213/CL82263/CL82313/CL82363/CL82413/CL82463/CL82513/CL83113/CL83213/CL83263/CL83313/CL83363/CL83413/CL83463 telephone.
- Make sure you plug the telephone line cord securely into the telephone base and telephone jack. Make sure you plug in the power cord securely.
- The cordless handset may be too far from the telephone base.
- Charge the battery in the cordless handset for at least 10 hours. For optimum daily performance, return the cordless handset to the telephone base or charger when not in use.
- You may have too many extension phones on your telephone line to allow all of them to ring simultaneously. Try unplugging some of the other phones.
- The layout of your home or office might be limiting the operating range. Try moving the telephone base to another location, preferably on an upper floor.
- If the other phones in your home are having the same problem, contact your telephone service provider (charges might apply).
- Test a working phone at the phone jack. If another phone has the same problem, contact your telephone service provider (charges might apply).
- Other electronic products such as HAM radios and other DECT phones can cause interference with your cordless phone. Try installing your phone as far away as possible from these types of electronic devices.
- Completely remove the battery. Replace it and place the cordless handset into the telephone base. Allow up to one minute for the handset to reestablish its connection with the telephone base.
- Your line cord might be defective. Try installing a new line cord.

Troubleshooting

My calls cut in and out while I'm using my cordless handset.

- Other electronic products such as HAM radios and other DECT phones can cause interference with your cordless phone. Try installing your phone as far away as possible from these types of electronic devices.
- Do not install this phone near a microwave oven or on the same electrical outlet. You might experience decreased performance while the microwave oven is operating.
- If you plug your phone in with a modem or surge protector, try plugging the phone (or modem/surge protector) into a different location. If this does not solve the problem, relocate your phone or modem farther apart from one another, or use a different surge protector.
- Move your telephone base to a higher location. The phone might have better reception when installed in a high area.
- If other phones in your home are having the same problem, contact your telephone service provider (charges may apply).

My caller ID isn't working.

- Caller ID is a subscription service. You must subscribe to this service from your telephone service provider for this feature to work on your phone.
- The caller may not be calling from an area that supports caller ID.
- Both your and your caller's telephone service providers must use caller ID compatible equipment.
- If you subscribe to high-speed Internet service (DSL - digital subscriber line) through your telephone line, you must install a DSL filter between the telephone line cord and the telephone wall jack. The filter prevents noise and caller ID problems resulting from DSL interference. Contact your DSL service provider for more information about DSL filters.

Troubleshooting

System does not receive caller ID when on a call.

- Make sure you subscribe to caller ID with call waiting features from your telephone service provider. Caller ID features work only if both you and the caller are in areas offering caller ID service, and if both telephone service providers use compatible equipment.

I subscribe to a nontraditional telephone service that uses my computer to establish connections, and my telephone doesn't work.

- Make sure your computer is powered on.
- Make sure your Internet connection is working properly.
- Make sure that the software is installed and running for your nontraditional telephone service.
- Make sure to plug your USB telephone adapter into a dedicated USB port on your computer. Do not plug it into a multiple port USB hub (USB splitter) that is not powered.
- In a few rare instances, the USB port on your computer may not have enough power. In these instances, try using a USB hub with its own external power supply.
- If you are using a firewall, it may prevent access to your nontraditional telephone service provider. Contact your service provider for more information.

Troubleshooting

The charge light is off.

- Make sure you plug the power and line cords in correctly and securely.
- Unplug the electrical power. Wait for 15 seconds, then plug it back in. Allow up to one minute for the cordless handset and telephone base to reset.
- Clean the cordless handset, charger and telephone base charging contacts each month with a pencil eraser or cloth.
- The battery may not be connected to the handset or is missing completely. Ensure that the battery is installed properly.

I've set my LCD language to Spanish or French and I don't know how to change it back to English.

- Press **MENU/SELECT** in idle mode. Enter **364#** using the dialing keys. You hear a confirmation tone.

Common cure for electronic equipment.

If the telephone does not seem to be responding normally, try putting the cordless handset in the charger. If it does not fix the problem, do the following (in the order listed):

1. Disconnect the power to the telephone base.
2. Disconnect the cordless handset battery.
3. Wait a few minutes.
4. Connect power to the telephone base.
5. Completely remove the battery. Replace the battery and place the cordless handset into the telephone base or charger.
6. Wait for the cordless handset to reestablish its connection with the telephone base. Allow up to one minute for this to take place.

Maintenance

Taking care of your telephone

- Your cordless telephone contains sophisticated electronic parts, so you must treat it with care.
- Avoid rough treatment.
- Place the handset down gently.
- Save the original packing materials to protect your telephone if you ever need to ship it.

Avoid water

- You can damage your telephone if it gets wet. Do not use the handset in the rain, or handle it with wet hands. Do not install the telephone base near a sink, bathtub or shower.

Electrical storms

- Electrical storms can sometimes cause power surges harmful to electronic equipment. For your own safety, take caution when using electric appliances during storms.

Cleaning your telephone

- Your telephone has a durable plastic casing that should retain its luster for many years. Clean it only with a soft cloth slightly dampened with water or mild soap.
- Do not use excess water or cleaning solvents of any kind.

Remember that electrical appliances can cause serious injury if used when you are wet or standing in water. If the telephone base should fall into water, DO NOT RETRIEVE IT UNTIL YOU UNPLUG THE POWER CORD AND TELEPHONE LINE CORDS FROM THE WALL. Pull the unit out by the unplugged cords.

Important safety information



This symbol is to alert you to important operating or servicing instructions that may appear in this user's manual. Always follow basic safety precautions when using this product to reduce the risk of injury, fire, or electric shock.

Safety information

- Read and understand all instructions in the user's manual. Observe all markings on the product.
- Avoid using a telephone during a thunderstorm. There may be a slight chance of electric shock from lightning.
- Do not use a telephone in the vicinity of a gas leak. Under certain circumstances, a spark may be created when the adapter is plugged into the power outlet, or when the handset is replaced in its cradle. This is a common event associated with the closing of any electrical circuit. The user should not plug the phone into a power outlet, and should not put a charged handset into the cradle, if the phone is located in an environment containing concentrations of flammable or flame-supporting gases, unless there is adequate ventilation. A spark in such an environment could create a fire or explosion. Such environments might include: medical use of oxygen without adequate ventilation; industrial gases (cleaning solvents; gasoline vapors; etc.); a leak of natural gas; etc.
- Do not use this product near water, or when you are wet. For example, do not use it in a wet basement or shower, or next to a swimming pool, bathtub, kitchen sink, or laundry tub. Do not use liquids or aerosol sprays for cleaning. If the product comes in contact with any liquid, unplug any line or power cord immediately. Do not plug the product back in until it has dried thoroughly.
- Install this product in a protected location where no one can trip over any line or power cords. Protect cords from damage or abrasion.
- If this product does not operate normally, see the **Troubleshooting** section on pages 11-18 of this user's manual. If you cannot solve the problem, or if the product is damaged, refer to the **Limited warranty** section pages 27-29. Do not open this product except as directed in your user's manual. Opening the product or reassembling it incorrectly may expose you to hazardous voltages or other risks.
- Replace batteries only as described in your user's manual (pages 6-7). Do not burn or puncture batteries — they contain caustic chemicals.
- This power adapter is intended to be correctly oriented in a vertical or floor mount position. The prongs are not designed to hold the plug in place if it is plugged into a ceiling or an under-the-table/cabinet outlet.



Caution: Use only the power adapter provided with this product. To obtain a replacement, visit our website at **www.telephones.att.com** or call **1 (800) 222-3111**. In Canada, dial **1 (866) 288-4268**.

Important safety information

Especially about cordless telephones

- **Privacy:** The same features that make a cordless telephone convenient create some limitations. Telephone calls are transmitted between the telephone base and the handset by radio waves, so there is a possibility that your cordless telephone conversations could be intercepted by radio receiving equipment within range of the cordless handset. For this reason, you should not think of cordless telephone conversations as being as private as those on corded telephones.
- **Electrical power:** The telephone base of this cordless telephone must be connected to a working electrical outlet which is not controlled by a wall switch. Calls cannot be made from the handset if the telephone base is unplugged, switched off or if the electrical power is interrupted.
- **Potential TV interference:** Some cordless telephones operate at frequencies that may cause interference to TVs and VCRs. To minimize or prevent such interference, do not place the telephone base of the cordless telephone near or on top of a TV or VCR. If interference is experienced, moving the cordless telephone farther away from the TV or VCR will often reduce or eliminate the interference.
- **Rechargeable batteries:** This product contains nickel-metal hydride rechargeable batteries. Exercise care in handling batteries in order not to create a short circuit with conductive material such as rings, bracelets, and keys. The battery or conductor may overheat and cause harm. Observe proper polarity between the battery and the battery charger.
- **Nickel-metal hydride rechargeable batteries:** Dispose of these batteries in a safe manner. Do not burn or puncture. Like other batteries of this type, if burned or punctured, they could release caustic material which could cause injury.



The RBRC™ Seal means that the manufacturer is voluntarily participating in an industry program to collect and recycle nickel-metal hydride rechargeable batteries when taken out of service within the United States. These batteries may be taken to a participating local retailer of replacement batteries or recycling center. Or you may call 1 (800) 8-BATTERY for locations accepting spent Ni-MH batteries.

Important safety information

Precautions for users of implanted cardiac pacemakers

Cardiac pacemakers (applies only to digital cordless telephones):

Wireless Technology Research, LLC (WTR), an independent research entity, led a multidisciplinary evaluation of the interference between portable wireless telephones and implanted cardiac pacemakers. Supported by the U.S. Food and Drug Administration, WTR recommends to physicians that:

Pacemaker patients

Should keep wireless telephones at least six inches from the pacemaker.

Should NOT place wireless telephones directly over the pacemaker, such as in a breast pocket, when it is turned ON.

Should use the wireless telephone at the ear opposite the pacemaker.

WTR's evaluation did not identify any risk to bystanders with pacemakers from other persons using wireless telephones.

ECO mode

This power conserving technology reduces power consumption for optimal battery performance. The ECO mode activates automatically whenever the handset is synchronized with the telephone base.

Especially about telephone answering systems

Two-way recording: This unit does not sound warning beeps to inform the other party that the call is being recorded. To ensure that you are in compliance with any federal or state regulations regarding recording a telephone call, you should start the recording process and then inform the other party that you are recording the conversation.

SAVE THESE INSTRUCTIONS

FCC Part 68 and ACTA

This equipment complies with Part 68 of the FCC rules and with technical requirements adopted by the Administrative Council for Terminal Attachments (ACTA). The label on the back or bottom of this equipment contains, among other things, a product identifier in the format US:AAAEQ##TXXXX. This identifier must be provided to your telephone service provider upon request.

The plug and jack used to connect this equipment to premises wiring and the telephone network must comply with the applicable Part 68 rules and technical requirements adopted by ACTA. A compliant telephone cord and modular plug is provided with this product. It is designed to be connected to a compatible modular jack that is also compliant. An RJ11 jack should normally be used for connecting to a single line and an RJ14 jack for two lines. See the installation instructions in the user's manual.

The Ringer Equivalence Number (REN) is used to determine how many devices you may connect to your telephone line and still have them ring when you are called. The REN for this product is encoded as the 6th and 7th characters following the US: in the product identifier (e.g., if ## is 03, the REN is 0.3). In most, but not all areas, the sum of all RENs should be five (5.0) or less. For more information, please contact your telephone service provider.

This equipment may not be used with Party Lines. If you have specially wired alarm dialing equipment connected to your telephone line, ensure the connection of this equipment does not disable your alarm equipment. If you have questions about what will disable the alarm equipment, consult your telephone service provider or a qualified installer.

If this equipment is malfunctioning, it must be unplugged from the modular jack until the problem has been corrected. Repairs to this telephone equipment can only be made by the manufacturer or its authorized agents. For repair procedures, follow the instructions outlined under the Limited warranty.

If this equipment is causing harm to the telephone network, the telephone service provider may temporarily discontinue your telephone service. The telephone service provider is required to notify you before interrupting service. If advance notice is not practical, you will be notified as soon as possible. You will be given the opportunity to correct the problem and the telephone service provider is required to inform you of your right to file a complaint with the FCC. Your telephone service provider may make changes in its facilities, equipment, operation, or procedures that could affect the proper functioning of this product. The telephone service provider is required to notify you if such changes are planned.

If this product is equipped with a corded or cordless handset, it is hearing aid compatible.

If this product has memory dialing locations, you may choose to store emergency telephone numbers (e.g., police, fire, medical) in these locations. If you do store or test emergency numbers, please:

Remain on the line and briefly explain the reason for the call before hanging up.

Perform such activities in off-peak hours, such as early morning or late evening.

FCC Part 68 and ACTA

Industry Canada

Operation is subject to the following two conditions: (1) this device may not cause harmful interference, and (2) this device must accept any interference, including interference that may cause undesired operation.

The term "IC:" before the certification/registration number only signifies that the Industry Canada technical specifications were met.

The Ringer Equivalence Number (REN) for this terminal equipment is 1.0. The REN is an indication of the maximum number of devices allowed to be connected to a telephone interface. The termination on an interface may consist of any combination of devices subject only to the requirement that the sum of the RENs of all the devices does not exceed five.

This product meets the applicable Industry Canada technical specifications.

FCC Part 15

This equipment has been tested and found to comply with the requirements for a Class B digital device under Part 15 of the Federal Communications Commission (FCC) rules. These requirements are intended to provide reasonable protection against harmful interference in a residential installation. This equipment generates, uses and can radiate radio frequency energy and, if not installed and used in accordance with the instructions, may cause harmful interference to radio communications. However, there is no guarantee that interference will not occur in a particular installation. If this equipment does cause harmful interference to radio or television reception, which can be determined by turning the equipment off and on, the user is encouraged to try to correct the interference by one or more of the following measures:

- Reorient or relocate the receiving antenna.
- Increase the separation between the equipment and receiver.
- Connect the equipment into an outlet on a circuit different from that to which the receiver is connected.
- Consult the dealer or an experienced radio/TV technician for help.

Changes or modifications to this equipment not expressly approved by the party responsible for compliance could void the user's authority to operate the equipment.

This device complies with Part 15 of the FCC Rules. Operation is subject to the following two conditions: (1) this device may not cause harmful interference, and (2) this device must accept any interference received, including interference that may cause undesired operation. Privacy of communications may not be ensured when using this telephone.

To ensure safety of users, the FCC has established criteria for the amount of radio frequency energy that can be safely absorbed by a user or bystander according to the intended usage of the product. This product has been tested and found to comply with the FCC criteria. The handset may be safely held against the ear of the user. The telephone base shall be installed and used such that parts of the user's body other than the hands are maintained at a distance of approximately 20 cm (8 inches) or more.

This Class B digital apparatus complies with Canadian ICES-003.



California Energy Commission battery charging testing instructions

This telephone is set up to comply with the energy-conserving standards right out of the box. These instructions are intended for California Energy Commission (CEC) compliance testing only. When the CEC battery charging testing mode is activated, all telephone functions, except battery charging, will be disabled.

When first purchased and properly installed for charging (see the **Battery installation and charging** section on page 7), put the cordless handset in the handset charger to charge. The CEC battery charging testing mode is activated while charging.

If you have registered the cordless handset to the CL81113/CL81213/CL81313/CL82113/CL82213/CL82263/CL82313/CL82363/CL82413/CL82463/CL82513/CL83113/CL83213/CL83263/CL83313/CL83363/CL83413/CL83463 base, below are the testing instructions.

To activate the CEC battery charging testing mode:

1. Unplug the telephone base power adapter from the power outlet. Make sure all cordless handsets are plugged with charged batteries and out of the chargers before proceeding.
2. While you **press and hold** /HANDSET LOCATOR, plug the telephone base power adapter back to the power outlet.
3. After about 20 seconds, when the **IN USE** light starts flashing, release /HANDSET LOCATOR and then press it again within two seconds.



The process takes up to one minute to complete. When the cordless handsets successfully enter the CEC battery charging testing mode, the **IN USE** light turns off and all handsets display **To register HS, see manual**. You hear a confirmation tone.

When the cordless handsets fail to enter this mode, repeat the steps above.

Note: The telephone base will be powered up as normal if you fail to press /HANDSET LOCATOR within two seconds in Step 3.

To deactivate the CEC battery charging testing mode:

1. Unplug the telephone base power adapter from the power outlet, then plug it back in. The telephone base is powered up as normal.
2. Register your handsets back to the telephone base. See pages 8-9 for handset registration instructions.



Limited warranty

The AT&T brand is used under license - any repair, replacement or warranty service, and all questions about this product should be directed to our website at

www.telephones.att.com or call **1 (800) 222-3111**. In Canada, dial **1 (866) 288-4268**.

1. What does this limited warranty cover?

The manufacturer of this AT&T branded product warrants to the holder of a valid proof of purchase (“CONSUMER” or “you”) that the product and all accessories provided in the sales package (“PRODUCT”) are free from defects in material and workmanship, pursuant to the following terms and conditions, when installed and used normally and in accordance with the PRODUCT operating instructions. This limited warranty extends only to the CONSUMER for products purchased and used in the United States of America and Canada.

2. What will be done if the PRODUCT is not free from defects in materials and workmanship during the limited warranty period (“materially defective PRODUCT”)?

During the limited warranty period, the manufacturer’s authorized service representative will repair or replace at the manufacturer’s option, without charge, a materially defective PRODUCT. If the manufacturer repairs the PRODUCT, they may use new or refurbished replacement parts. If the manufacturer chooses to replace the PRODUCT, they may replace it with a new or refurbished PRODUCT of the same or similar design. The manufacturer will retain defective parts, modules, or equipment. Repair or replacement of the PRODUCT, at the manufacturer’s option, is your exclusive remedy. The manufacturer will return repaired or replacement products to you in working condition. You should expect the repair or replacement to take approximately 30 days.

3. How long is the limited warranty period?

The limited warranty period for the PRODUCT extends for ONE (1) YEAR from the date of purchase. If the manufacturer repairs or replaces a materially defective PRODUCT under the terms of this limited warranty, this limited warranty also applies to repaired or replacement PRODUCT for a period of either (a) 90 days from the date the repaired or replacement PRODUCT is shipped to you or (b) the time remaining on the original one-year limited warranty; whichever is longer.

4. What is not covered by this limited warranty?

This limited warranty does not cover:

- PRODUCT that has been subjected to misuse, accident, shipping or other physical damage, improper installation, abnormal operation or handling, neglect, inundation, fire, water, or other liquid intrusion; or
- PRODUCT that has been damaged due to repair, alteration, or modification by anyone other than an authorized service representative of the manufacturer; or

Limited warranty

- PRODUCT to the extent that the problem experienced is caused by signal conditions, network reliability or cable or antenna systems; or
- PRODUCT to the extent that the problem is caused by use with non-AT&T accessories; or
- PRODUCT whose warranty/quality stickers, PRODUCT serial number plates or electronic serial numbers have been removed, altered or rendered illegible; or
- PRODUCT purchased, used, serviced, or shipped for repair from outside the United States of America or Canada, or used for commercial or institutional purposes (including but not limited to products used for rental purposes); or
- PRODUCT returned without valid proof of purchase (see item 6 below); or
- Charges for installation or setup, adjustment of customer controls, and installation or repair of systems outside the unit.

5. How do you get warranty service?

To obtain warranty service, visit **www.telephones.att.com** or call **1 (800) 222-3111**. In Canada, dial **1 (866) 288-4268**.

NOTE: Before calling for service, please review the user's manual; a check of the PRODUCT's controls and features may save you a service call.

Except as provided by applicable law, you assume the risk of loss or damage during transit and transportation and are responsible for delivery or handling charges incurred in the transport of the PRODUCT(s) to the service location. The manufacturer will return repaired or replaced PRODUCT under this limited warranty to you. Transportation, delivery or handling charges are prepaid. The manufacturer assumes no risk for damage or loss of the PRODUCT in transit. If the PRODUCT failure is not covered by this limited warranty, or proof of purchase does not meet the terms of this limited warranty, the manufacturer will notify you and will request that you authorize the cost of repair prior to any further repair activity. You must pay for the cost of repair and return shipping costs for the repair of products that are not covered by this limited warranty.

6. What must you return with the PRODUCT to get warranty service?

You must:

- Return the entire original package and contents including the PRODUCT to the service location along with a description of the malfunction or difficulty; and
- Include a "valid proof of purchase" (sales receipt) identifying the PRODUCT purchased (PRODUCT model) and the date of purchase or receipt; and
- Provide your name, complete and correct mailing address, and telephone number.

Limited warranty

7. Other limitations

This warranty is the complete and exclusive agreement between you and the manufacturer of this AT&T branded PRODUCT. It supersedes all other written or oral communications related to this PRODUCT. The manufacturer provides no other warranties for this PRODUCT. The warranty exclusively describes all of the manufacturer's responsibilities regarding the PRODUCT. There are no other express warranties. No one is authorized to make modifications to this limited warranty and you should not rely on any such modification.

State/Provincial Law rights: This warranty gives you specific legal rights, and you may also have other rights which vary from state to state or province to province.

Limitations: Implied warranties, including those of fitness for a particular purpose and merchantability (an unwritten warranty that the PRODUCT is fit for ordinary use) are limited to one year from date of purchase. Some states/provinces do not allow limitations on how long an implied warranty lasts, so the above limitation may not apply to you. In no event shall the manufacturer be liable for any indirect, special, incidental, consequential, or similar damages (including, but not limited to lost profits or revenue, inability to use the PRODUCT or other associated equipment, the cost of substitute equipment, and claims by third parties) resulting from the use of this PRODUCT. Some states/provinces do not allow the exclusion or limitation of incidental or consequential damages, so the above limitation or exclusion may not apply to you.

Please retain your original sales receipt as proof of purchase.

Technical specifications

RF frequency band	1921.536MHz - 1928.448MHz
Channels	5
Operating temperature	32°F - 122°F 0°C - 50°C
Handset voltage	2.4VDC - 3.2VDC
Charger voltage (AC adapter output)	6VAC @ 300mA

Operation	Operating time*
Talk time (cordless handset)	Up to seven hours
Talk time (cordless handset speakerphone)	Up to five hours
Standby	Up to seven days

* Operating times vary depending on your actual use and the age of the battery.

DECT 6.0 digital technology

The AT&T DECT 6.0 products offer unsurpassed range performance and sound clarity. This is achieved through a unique antenna design and advances in noise-filtering technology. An independent laboratory has confirmed that AT&T DECT 6.0 products perform up to 45% better in range competitions against similarly equipped phones of the leading competition. Now calls can be taken in the basement, backyard and garage with exceptional sound quality.

Telephone operating range

This cordless telephone operates within the maximum power allowed by the Federal Communications Commission (FCC). Even so, this handset and telephone base can communicate over only a certain distance — which can vary with the locations of the telephone base and handset, the weather, and the construction of your home or office.

Redefining long range coverage and clarity

This telephone base comes with an antenna which gives much better clarity and covers a longer range than before.

HD audio

HD audio improves sound quality by expanding and rebuilding frequencies that are lost with traditional phone calls. There is no additional telephone service requirement to use HD audio. It is designed to work with standard telephone service. Your system will automatically enhance all received sound with HD audio.



www.telephones.att.com