

# Uniden®

UM725GBT  
UM725G  
UM725

VHF MARINE RADIO

RADIO VHF MARITIME



## OWNER'S MANUAL GUIDE D'UTILISATION

This User's Guide provides usage instruction for all models listed above.

Ce guide d'utilisation fournit des instructions d'utilisation pour tous les modèles énumérés ci-dessus.

# MAKING A DISTRESS CALL

Lift the red cover. Press and hold the DISTRESS key for three seconds. Your radio transmits your ship's location every few minutes until you receive a response.

NOTE: If the radio displays *Enter User MMSI*, cancel the automatic distress call and make a normal voice distress call.



Lift the red cover and press the DISTRESS button underneath

## Making a Voice Distress Call

Speak slowly - clearly - calmly.

For future reference, write your ship's name & call sign here:

1. Make sure your radio is on.
2. Press the **16/P** key to switch to Channel 16 (156.8 MHz). (If the corner of the display does not show 16, press the **16/P** key again until it does.)
3. Press the **PUSH-TO-TALK** key and say: "**MAYDAY -- MAYDAY -- MAYDAY.**"
4. Say "**THIS IS** {name of your ship (three times)} and call sign/ship registration number (once)."
5. Repeat "**MAYDAY** {name of your ship}" once.
6. Tell where you are: (what navigational aids or landmarks are near, or read the latitude and longitude from your GPS).
7. State the nature of your distress (e.g. are you sinking, medical emergency, man overboard, on fire, adrift, etc. ).
8. State the type of assistance you need (medical, towing, pumps, etc.).
9. Give number of persons aboard and conditions of any injured persons.
10. Estimate present seaworthiness of your ship (e.g. how immediate is the danger due to flooding or fire or proximity to shore).
11. Briefly describe your ship, giving ship name (e.g. "Blue Duck is 32 foot cabin cruiser, white hull, blue deck house").
12. Say: "**I WILL BE LISTENING ON CHANNEL 16.**"
13. End message by saying "**THIS IS** {name or call sign of your ship}, **OVER.**"
14. Release the **PUSH-TO-TALK** key and listen.

If you do not get an answer after 30 seconds, repeat your call, beginning at step 3, above.

# FAIRE UN APPEL DE DÉTRESSE

Soulevez le couvercle noir. Maintenez **DISTRESS** enfoncé pendant trois secondes. Votre radio transmettra l'emplacement de votre bateau toutes les quelques minutes jusqu'à ce que vous receviez une réponse.

Remarque : Si la radio affiche *Enter User MMSI*, annulez l'appel de détresse automatique et effectuez un appel de détresse vocal normal.



Soulevez le couvercle et appuyez sur le bouton **DISTRESS** en dessous

## Faire un appel de détresse

**Parlez lentement – clairement – calmement.**

Pour toute référence ultérieure, écrivez ci-dessous le nom et l'indicatif d'appel de votre bateau:

1. Vérifiez si votre radio est en marche.
2. Appuyez sur la touche **16/P** afin de commuter au canal 16 (156,8 MHz). (Si le canal 16 n'apparaît pas à l'affichage, appuyez de nouveau sur la touche **16/P** jusqu'à ce qu'il soit affiché.)
3. Appuyez sur le bouton **PUSH-TO-TALK** et dites: "**MAYDAY -- MAYDAY -- MAYDAY**".
4. Donnez l'identité de votre navire en disant : "**ICI {nom de votre bateau (trois fois) ou indicatif d'appel et le numéro d'identification de votre bateau (une fois)}**".
5. Dites "**MAYDAY {nom ou indicatif d'appel de votre bateau}** une fois".
6. Donnez votre position : (quels sont les points de repère ou aides à la navigation près de vous ou lisez les coordonnées de longitude et de latitude apparaissant sur votre dispositif GPS).
7. Révélez la nature de votre détresse (par exemple, nous sommes en train de couler, urgence médicale, un homme à la mer, un incendie, nous sommes à la dérive, etc.
8. Révélez la nature de l'aide désirée (médicale, remorquage, essence, etc.)
9. Donnez le nombre de personnes à bord et les conditions des blessés, s'il y en a.
10. Donnez la condition de navigabilité actuelle de votre navire, tel que le degré de l'urgence par rapport une inondation, et une incendie.
11. Donnez une brève description de votre navire en donnant le nom du bateau (par exemple, "Blue Duck est un yacht de croisière de 32 pieds, avec une coque blanche et un roufille bleu.).
12. Dites : "**JE VAIS ÉCOUTER SUR LE CANAL 16**".
13. Terminez le message en disant "**ICI {nom ou indicatif d'appel de votre bateau}, À VOUS**".
14. Relâchez le bouton **PUSH-TO-TALK** du microphone et écoutez.

Si vous n'obtenez pas de réponse après 30 secondes, répétez l'appel en commençant à l'étape 3 ci-dessus.

# Table of Contents

What's Included .....	E-2
<b>INSTALLATION .....</b>	<b>E-3</b>
Mounting the radio .....	E-3
Connecting the radio .....	E-5
Accessory Cable .....	E-6
<b>YOUR UM725 VHF MARITIME RADIO .....</b>	<b>E-7</b>
<b>MMSI NUMBER .....</b>	<b>E-8</b>
Reading the Radio Screen .....	E-9
Menus .....	E-10
Soft Keys .....	E-12
<b>SETTING UP YOUR RADIO .....</b>	<b>E-14</b>
General Setup .....	E-14
Radio Setup .....	E-15
Time Settings .....	E-15
<b>OPERATING THE RADIO .....</b>	<b>E-16</b>
Monitoring a Channel (Normal Mode) .....	E-16
Setting the Squelch Level .....	E-16
Scanning Radio Channels .....	E-17
Monitoring Weather Channels .....	E-18
Priority and Weather Alert Watch .....	E-20
Priority Watch .....	E-20
Weather Alert Watch .....	E-21
<b>DIGITAL SELECTIVE CALLING (DSC) .....</b>	<b>E-22</b>
What Is DSC? .....	E-22
How Does DSC Work? .....	E-22
Managing DSC Settings .....	E-23
Setting up DSC Individuals and Groups .....	E-24
DSC Calls .....	E-26
DSC Call Logs .....	E-29
Making a Transmission .....	E-30
Position Requests .....	E-31
DSC Self Test .....	E-33
Receiving a Distress Call .....	E-33
Making an Automatic Distress Call .....	E-34
MOB Soft Key .....	E-34
<b>GPS FEATURES .....</b>	<b>E-36</b>
<b>Navigation .....</b>	<b>E-38</b>
Waypoints and Routes .....	E-38
Accessing Navigation .....	E-40
Parameter Settings .....	E-41

---

<b>NMEA Operation .....</b>	<b>E-42</b>
NMEA0183 Input.....	E-42
Position Data Output.....	E-43
<b>MAINTENANCE AND TROUBLESHOOTING.....</b>	<b>E-44</b>
Resetting Your Radio .....	E-45
<b>SPECIFICATIONS.....</b>	<b>E-46</b>
<b>REFERENCE TABLES .....</b>	<b>E-47</b>
Marine Radio Channel Chart.....	E-47
USA Frequency Chart .....	E-48
Canadian Frequency Chart.....	E-49
International Frequency Chart.....	E-50
Weather Channels and Frequencies (Us, Can, And Intl) .....	E-52
Emergency Alert (SAME) System Event Types .....	E-52
NMEA2000 PGN LIST (UM725GBT / UM725G ONLY) .....	E-55
<b>REGULATIONS AND SAFETY WARNINGS .....</b>	<b>E-56</b>
Maritime Radio Services Operation .....	E-56
Basic Radio Guidelines.....	E-56
Compliance .....	E-57
<b>THREE-YEAR LIMITED WARRANTY .....</b>	<b>E-59</b>

---

# UNIDEN® VHF MARINE RADIO (UM725)

- **UM725GBT:** NMEA2000 Compatible VHF Marine Radio with GPS and Bluetooth – Class D DSC radio with integrated GPS and Bluetooth, so you can use Uniden's smartphone app (iOS and Android) to set up the radio and text message other VHF text message capable radios.
- **UM725G:** NMEA2000 Compatible VHF Marine Radio with GPS – Class D DSC radio with integrated GPS receiver.
- **UM725:** VHF Marine Radio – Class D DSC radio

Your radio provides the following key features:

- **DSC.** Provides communication to other ships or groups using their unique identification code. This radio includes a second **Class D Receiver** to Monitor only DSC watch channel 16 (dedicated) to ensure that no incoming messages are missed.
- **GPS (Favorite Position mode).** Saves your current position or lets you manually enter other positions. Provides a directory to save positions for return as desired. Provides a list of saved waypoints and routes that you can save and use to navigate.
- **NMEA2000 Compatibility (UM725GBT/UM725G).** Provides connection to a chartplotter and, through menus, determine what NMEA data you want to receive.
- **Compass Display.** Programmable to display your course - by showing your course and direction or by showing location on an north-south-east-west display. Automatically auto-plots to a received DSC distress call.
- **MOB (Man Overboard).** Locks onto the current position in Man Overboard situations.
- **National Oceanic and Atmospheric Administration (NOAA) Weather Channel watch.** Alerts you when an alert is issued, on **10** available **weather channels**.
- **Memory Scan. Monitors** saved channels in quick succession. All marine VHF channels for the U.S., Canada, and international waters
- **Dual- Triple-Watch.** Monitors Coast Guard distress, hailing, or priority channels and one weather channel along with one regular marine channel.
- **Emergency Channel (16) Monitoring.** Checks this emergency channel while scanning.

## WHAT'S INCLUDED



**NOTE:** Some of the images in this manual may vary slightly from the actual product. If any pieces are missing or damaged, contact Customer Service at [www.uniden.com](http://www.uniden.com).

# INSTALLATION

## MOUNTING THE RADIO

The included mounting bracket allows your radio to sit at any angle to accommodate the best location. Select a location that can:

- Properly support the weight of the radio. You may need some type of anchor with mounting screws, depending on the surface.
- Keep the battery leads as short as possible.
- Keep the antenna lead-in wire as short as possible.
- Allow free air flow around the heat sink on the rear of the radio.
- Avoid interference with the ship's compass.

---

**Note:** To extend the life of the radio, use waterproofer's instructions. Attach a rubber cap to the unused connector.

---

### TO INSTALL THE MOUNTING BRACKET:

1. Slide the radio into the mounting bracket and tighten the mounting knobs to secure the radio in place.
2. Position the radio into the desired location and mark the edges of the bracket on the mounting surface.
3. Remove the **mounting bracket drill template** from the back of the manual, and use the template to mark the drill holes on the mounting surface.
4. Drill the holes for the mounting bracket; be sure to follow any special requirements of the mounting surface.
5. Remove the bracket from the radio and use the mounting hardware to secure the bracket to the mounting surface.
6. Install the radio back into the mounting bracket.

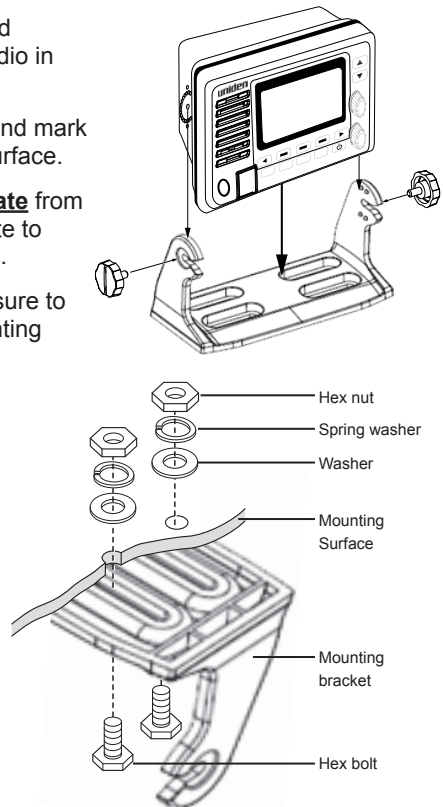

**TO INSTALL THE FLUSH-MOUNT BRACKET (OPTIONAL FMB323 FLUSH MOUNT KIT SOLD SEPARATELY)**

You will need an opening for that radio that measures 5.5" by 2.85" to fit into (large enough for the back of the radio to fit, but for the face of the radio to sit flush on the surface. You will need clearance of at least 3.5" behind the radio to accommodate all the necessary connections.

---

**Tip:** If you are cutting the opening in the surface, carefully examine the entire area before you begin, including clearance behind the surface. Make sure all connections can reach the radio. If you are uncertain of your placement, consult a professional.

---

1. Slide the radio into the surface opening.
2. Align the mounting brackets with the screw holes on the radio as indicated.
3. Insert and tighten the screws to secure the radio in place. The pads of the mounting brackets should press firmly against the interior of the mounting surface.

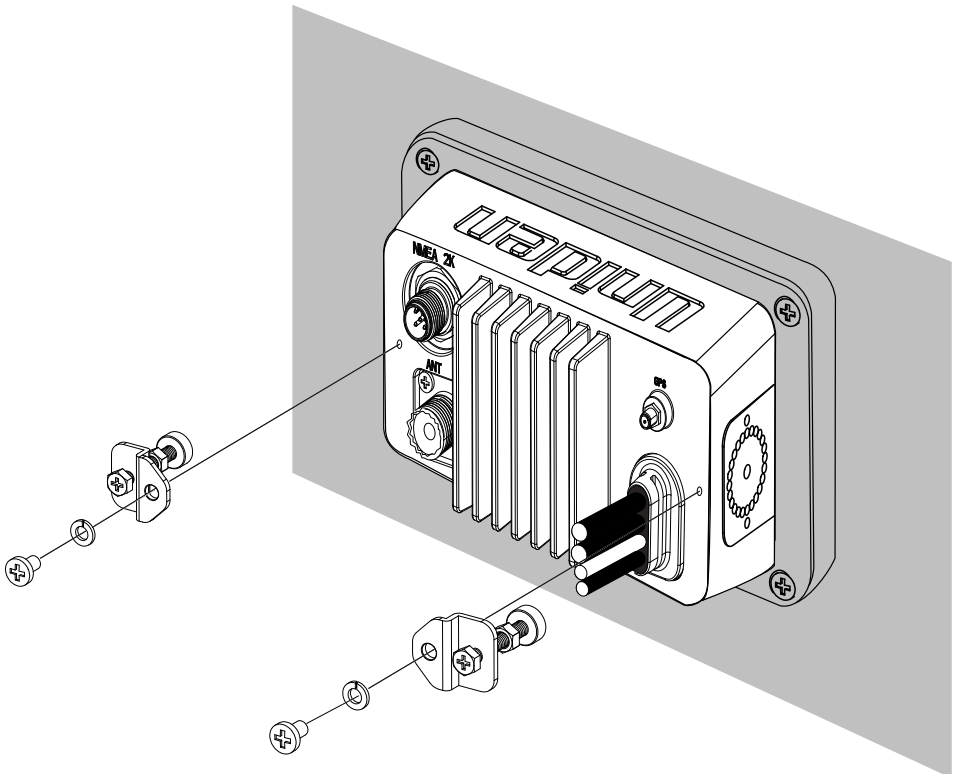



## CONNECTING THE RADIO

To operate correctly, your radio requires a power source and an antenna. Additionally, you can connect your radio to an external GPS antenna, chartplotter, and/or a remote microphone (Model UMRMIC, optional, sold separately).

Power Supply Requirements	VHF Antenna Requirements
<p>Nominal 13.8 VDC power supply with a negative ground (10.5 VDC to 16.0 VDC). Short power leads directly connected to the power supply is ideal.</p> <p>Copper wire extensions (minimums):</p> <ul style="list-style-type: none"> <li>◆ Up to 20 ft. – 14 AWG</li> <li>◆ 20-35 ft. – 12 AWG</li> <li>◆ 35-60 ft. – 10 AWG</li> </ul>	<p>PL-259 connector 50 Ω impedance</p> <p>Antenna rating (minimum):</p> <ul style="list-style-type: none"> <li>◆ Powerboats: 4 ft., 3 dB</li> <li>◆ Sailboats or 8 foot: 6dB</li> </ul> <p>Minimum lead-in wire:</p> <ul style="list-style-type: none"> <li>◆ Up to 20 ft. – RG-58</li> <li>◆ 20-35 ft. – RG-8X</li> <li>◆ 35-60 ft. – RG-8U</li> </ul>

### TO CONNECT YOUR RADIO:

1. Connect your boat's power supply using the black and red power connector.
2. Connect your radio antenna's PL-259 connector to the radio's **ANT** port.
3. You can connect your radio to your boat's navigation system using one of the following connectors:
  - **External GPS Antenna (UM725GBT/UM725G only)**
  - **NMEA2000 (UM725GBT/UM725G only)**
  - **Accessory Connector (NMEA0183)**

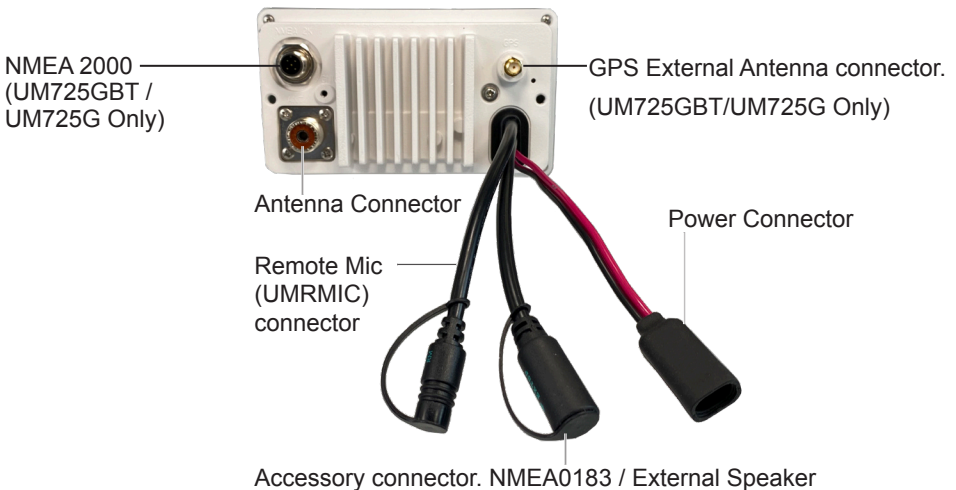

## ACCESSORY CABLE

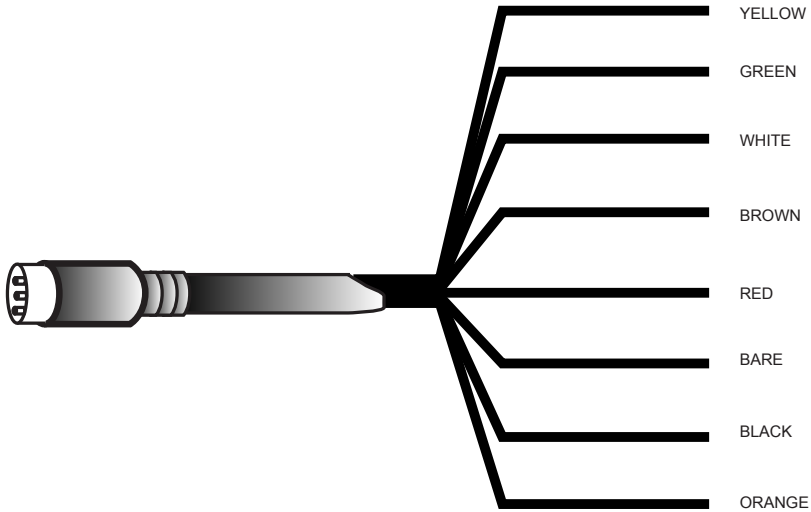

Wire Color	Description	Connects To...
Yellow	NMEA IN (+)	NMEA Data OUT (+) from GPS receiver
Green	NMEA IN (-)	NMEA Data OUT (-) from GPS receiver
White	NMEA OUT (+)	NMEA Data IN (+) on Chart plotter
Brown	NMEA OUT (-)	NMEA Data IN (-) on Chart plotter
Red	External Speaker (+)	External Speaker (+)
Bare	Ground /Ext. Speaker (-)	External Speaker (-)
Black	NC	
Orange	NC	

# YOUR UM725 VHF MARITIME RADIO

Your UM725 VHF Maritime Radio is designed to provide quick and easy access to critical functions and cool features. For most operation, the UM725 uses a 3-part operating structure: Physical Controls, Menus, and Soft Keys.

- Physical Controls – Use the radio's buttons and knobs to access and navigate various menu settings and functions.
- Menus – Press the **MENU** button to access and various menu settings and functions.
- Soft Keys – Use the dynamic Soft Key and scroll buttons to access features and make selections based on the current screen.



CH ▲ / ▼ – Cycle up and down through channels, and can be used to navigate menu options.

VOL – Volume

PUSH/SEL – Turn and press to highlight and select menu options, and to set Squelch settings.

POWER – Turns your radio on and off.

16/P – Cycles through call channel, channels 16 and a priority channel, and back to the starting channel.

CLEAR – Returns to the main screen.

MENU – Accesses the radio menus.

H/L – change the transmission power from 25W to 1W (If the maximum output for a channel is 1W only, the output power stays at 1W.)

Soft Keys – Activates assigned functions based on the screen above.

DISTRESS – Sends out default distress signal.



Push to Talk  
Speaker

Cycle up and down through channels

Cycles through call channel, channels 16 and Priority

## MMSI NUMBER

When you power up your radio for the first time, *MMSI Not Entered* appears, followed by a Marine mode screen. In order to use DSC features, you must be assigned an individual User MMSI number and program that number into your radio. User MMSI numbers are unique and cannot be entered more than once.

**If you choose to not enter your specific MMSI number at initial start up**, you can still use many of your radio's features. However, some radio functions will be impacted, and **you will not be able to use any DSC features.**

You can get more information on MMSI numbers at these resources:

- The dealer where you purchased the radio
- Recreational boaters can obtain an individual MMSI number from the Boat Owner's Association of the U.S. (<http://www.boatus.com/mmsi/> or call 800-563-1536) or Sea Tow Services International ([http://seatow.com/boating\\_safety/mmsi.asp](http://seatow.com/boating_safety/mmsi.asp))
- Commercial boaters need a ship station license to get an MMSI number. For more information, visit the Federal Communications Commission (FCC) website at <http://wireless.fcc.gov/marine/fctsht14.html>.

---

**Tip:** Before you begin this process, have your MMSI number available and familiarize yourself with the menu navigation on Page E-10. **Be sure you have the correct User MMSI number before entering it in the radio. The radio only allows you to enter the User MMSI once.** If you need to re-enter the User MMSI number, visit <http://support.uniden.com/marine-radios/> for assistance.

---

### TO ENTER YOUR MMSI NUMBER:

1. Press and hold the  button until the unit turns on. An **ATTENTION** message appears.
2. Press the **PROG** soft key. The ENTER MMSI screen appears.
3. Use the **PUSH/SELECT** knob to enter each digit of your MMSI number.
4. Press the **SAVE** Soft Key to save the MMSI number.

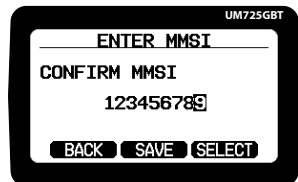
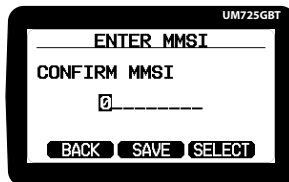

## READING THE RADIO SCREEN

Your radio screen shows a different combination of icons and information depending on the current operation, each designed to provide information intuitively.

DSC Call Log available

Bluetooth is turned on (UM725GBT ONLY)

Text message is available

Weather Alert ICON (ON)

Auto Polling (ON)

Status: TX (Transmitting) or BUSY (Receiving or Busy)

Channel Mode: (USA, CANadian or INternational)

WX - Weather Mode

GPS Status:  
 📶 - Internal GPS (UM725GBT / UM725G ONLY)  
 N- External NMEA0183 GPS Signal  
 2K - GPS signal from NMEA2000 (UM725GBT / UM725G ONLY)  
 Flashing = Acquiring  
 ON = Acquired

MEM – Channel saved in memory

Latitude (Top)

Longitude (Bottom)

Time/Date



4-digit channel

Channel Number

Channel Name

Soft Key Labels

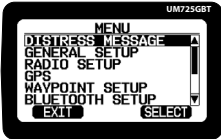
**Note:** Your UM725 VHF Radio is designed to be dynamic and flexible to provide many features. Therefore screens can vary depending on your unique settings. The screen below shows some commonly used screens that you may encounter.

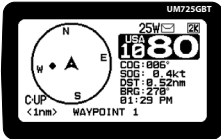
Menu Screens	Keyboard Screens	Compass Screen
 <p>Various menus let you access radio settings and functions using a combination of controls, such as the <b>PUSH/SELECT</b> knob, <b>CH ▲ ▼</b> buttons, or dynamic soft key options that appear.</p>	 <p>Keyboard screens appear when a setting requires a text entry. Use the <b>PUSH/SELECT</b> knob, <b>CH ▲ ▼</b> buttons, and dynamic soft key options that appear with the keyboards to enter text.</p>	 <p>The compass screen appears when you press the <b>COMP</b> soft key. Its appearance may vary depending on your unique radio settings.</p>

## MENUS

Various menus let you access settings for your radio, and various functions of your radio. You can navigate these menus using a combination of controls.

Press the **MENU** button to access the radio's main menu. Turn the **PUSH/SELECT** knob to select a menu item, then press the knob to open that menu.

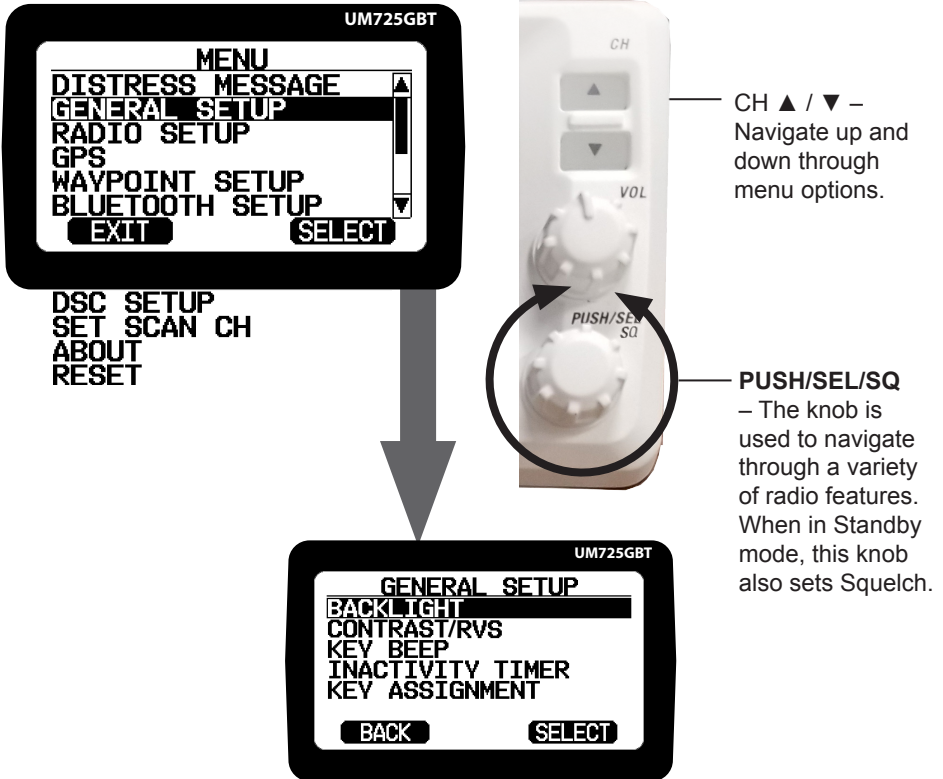

---

**Tip:** Your UM725 VHF Radio is designed to provide flexibility in its controls. You can navigate menus using several methods: the **PUSH/SELECT** knob, CH ▲ / ▼ buttons, and dynamic soft key options that appear. Familiarize yourself with how various navigation options work to find what works best for you. This will make navigation easier.

---

Main Menu	Description
DISTRESS MESSAGE	Opens a Submenu to select a distress messages type to transmit when you press the radio DISTRESS button. For more information regarding distress calls, see <b>"Making a Voice Distress Call"</b> on page ii.
GENERAL SETUP	Accesses basic configuration of general preferences, such as how the backlight and key beep function. For more information regarding general setup, see <b>"General Setup"</b> on page E-14.
RADIO SETUP	Accesses settings for radio functions, such as priority and weather alert watches. For more information regarding radio setup, see <b>"Radio Setup"</b> on page E-15.
GPS	Your GPS system provides more than just your specific location. You can determine power-saving options, measurement increments, and time settings. For more information regarding GPS functions, see <b>"GPS FEATURES"</b> on page E-36.
WAYPOINT SETUP	Waypoints (landmarks) mark specific points between two locations. They serve as directional indicators. For more information regarding waypoints, see <b>"Waypoints and Routes"</b> on page E-35.
BLUETOOTH SETUP	Accesses basic configuration of Bluetooth functions (UM725GBT models only). For more information regarding waypoints, see <b>"Setting Up Bluetooth (UM725GBT Only)"</b> on page E-35.
DSC SETUP	Accesses settings for Digital Selective Calling functions, such as setting up contacts for ship-to-ship and group communications. For more information regarding DSC setup, see <b>"Managing DSC Settings"</b> on page E-23.
SET SCAN CH	Lets you turn scanning on or off for specific channels. For more information regarding DSC setup, see <b>"Scanning Radio Channels"</b> on page E-17.
ABOUT	Displays the model number, software and hardware versions. serial number and MMSI number.
RESET	Resets factory defaults, except for the MMSI number.

## SOFT KEYS

Soft keys offer quick access to many radio functions, using only the three buttons immediately beneath the screen and the two scroll buttons.

**Note:** Some Soft Key functions may change appearance and operation based on radio settings. See "SETTING UP YOUR RADIO" on page E-14.

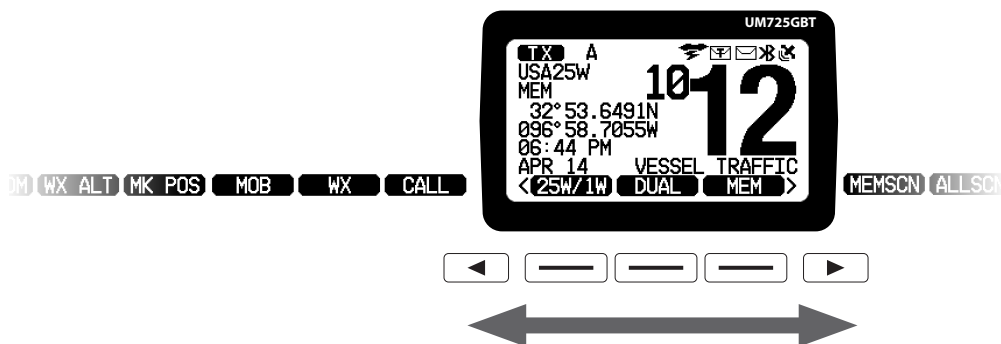

Press the buttons to quickly access the corresponding function. Use the scroll buttons to navigate through Soft Key Options.

Soft Key	Description
<b>MOB</b>	(Man Over Board) – The GPS automatically marks your current location as MOB and displays the latitude, longitude, time, BRG (Bearing to Destination), and DIST (Distance to Destination), saved in the Waypoint Directory as MARK XXX. The saved position can be used in as a waypoint.
<b>WX</b>	Displays the last weather channel accessed, latitude, longitude, and time. Turn the <b>PRESS/SELECT</b> knob to scroll through weather channels and press the knob to select that channel.
<b>CALL</b>	Use as a shortcut to making various calls. You can also send and receive position requests and view the DSC call logs.
<b>25W/1W</b>	Changes the transmission power from 1W to 25W. The transmission power icon displays.  (If the maximum output for a specific channel is 1W only, the output power stays to 1W and the radio sounds an error tone.)
<b>DUAL</b> <b>TRI</b>	Depending on your radio setup, this soft key displays TRI or DUAL. If TRI, the radio scans the current channel, channel 16, and the priority channel. If DUAL, the radio scans the current channel and channel 16.
<b>MEM</b>	Saves the current channel into memory. If the channel is already saved into memory, selecting this key will remove it from memory.



Soft Key	Description
<b>MEMSCN</b>	Scans channels saved into memory.
<b>ALLSCN</b>	Scans all available channels.
<b>COMP</b>	(Compass) – Activates the compass screen. Select the N-UP soft key to orient the radio to north. When in N-UP mode, the soft key changes to C-UP mode, which you can select to orient the compass to the course's next Waypoint, shown by a black dot.
<b>NAVI</b>	Accesses a previously stored route or waypoint as your destination.
<b>WPT</b>	(Waypoints) – Waypoints are location coordinates you've saved into the system. Select waypoints (location coordinates that you've previously saved in your radio) to navigate to.
<b>TXT</b>	Accesses text messages (view, send, and receive) and turn Bluetooth on and off (UM725GBT Only).
<b>BACKLT</b>	Changes the radio's backlight color between amber and white.
<b>MMSI</b>	Displays your MMSI number for reference.
<b>SPKR</b>	Sound a loud tone. The vibration from this tone helps remove water from the speaker.
<b>INT/PG</b>	Press to enter Intercom Mode, for conversations between the Main Unit and Remote Mic. Press and hold to sound a Page tone. Requires an optional Remote Mic (UMRMIC).
<b>WX ALT</b>	Activates the radio's Weather Alert Watch.
<b>MK POS</b>	Marks your current position, and gives you the option to name and save the marker (saved in the Waypoint Directory as MARK xxx). The saved position can be used in as a waypoint.

## SETTING UP YOUR RADIO

Even though you can change your radio's settings at any time, as needed, you will probably want to establish initial settings when you turn it on for the first time. Below are some basic settings that are recommended for initial set up.

### GENERAL SETUP

1. Press the **MENU** button, then turn the **PUSH/SEL** knob to select **GENERAL SETUP**. Press the **PUSH/SEL** knob, and the GENERAL SETUP submenu appears.
2. From here, you can use the **PUSH/SEL** knob and **▲** or **▼** buttons to access and customize general settings for your radio:

- **BACKLIGHT:**
  - **BACKLIGHT LEVEL** – brightness, Off - 8.
  - **BACKLIGHT COLOR** – White or amber.
- **CONTRAST/RVS** – contrast levels Off - 7, or invert the colors.
- **KEY BEEP** – Off - 7.
- **INACTIVITY TIMER** – When inactive for 1, 2, 3, 5, 8, or 10 minutes, the radio returns to the main screen.
- **KEY ASSIGNMENT** – Lets you reorder the soft key functions.

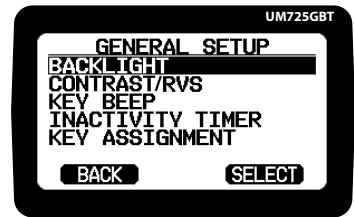
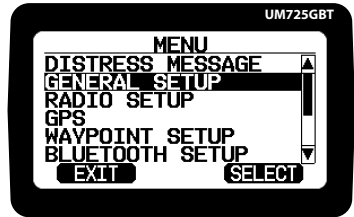

### TO SETUP A REMOTE MIC:

Your radio's supports access via remote mic (UMRMIC Optional). The **REMOTE MIC SETUP** menu appears only when a remote mic is connected.

1. Connect the Remote Menu to the Remote Mic Connector, marked **RM**, on your radio.
2. Press the **MENU** button on your radio and then use the **PUSH/SEL** knob to access the **REMOTE MIC SETUP** menu.
3. From here, you can use the **PUSH/SEL** knob and **▲** or **▼** buttons to access and customize general settings for your radio:

- **BACKLIGHT:**
  - **BACKLIGHT LEVEL** – brightness, Off - 8.
  - **BACKLIGHT COLOR** – White or amber.
- **CONTRAST/RVS** – contrast levels 1 - 20, or invert the colors.
- **KEY BEEP** – Off - 7.

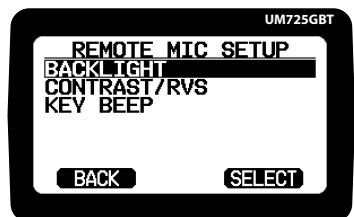
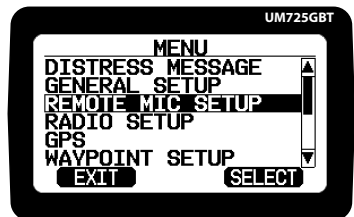

## RADIO SETUP

1. Press the **MENU** button, then turn the **PUSH/SEL** knob to select **RADIO SETUP**. Press the **PUSH/SEL** knob, and the **RADIO SETUP** submenu appears.
2. From here, you can use the **PUSH/SEL** knob and ▲ or ▼ buttons to access and customize settings used for various radio functions:

- **CHANNEL MODE** – **USA**, **CAN**, or **INTL**. (For USA, Canada, or International waters.)
- **WEATHER RADIO** – Activate Weather Alert Watch or enter FIPS Codes.
- **DUAL/TRI WATCH** – Your radio can scan channel 16 and the priority channel in the background.
- **PRIORITY CHANNEL** – DSC priority channel. (Default = 9).
- **SCAN PAUSE TIMER** – How long the radio will remain on a received transmission during scanning: 1, 2, 3, 4, 5, 10 seconds.
- **CHANNEL NAME** – Use to rename channels, if desired.
- **NOISE CANCEL** – ON/OFF for transmissions and receiving.
- **RECEIVE AUDIO PITCH** – Normal or Mid, High Boost, or Low Boost.

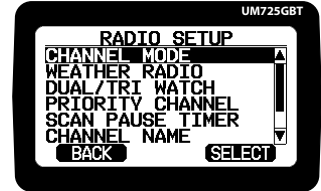
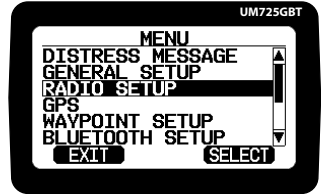

## TIME SETTINGS

Your radio's time display settings are accessed through the **GPS** menu.

1. Press the **MENU** button, and then use the **PUSH/SEL** knob to access the **GPS** menu.
2. From this menu, you can use the **PUSH/SEL** knob to access and customize **TIME DISPLAY** settings for your radio.
3. Use the **PUSH/SEL** knob to customize time settings for your radio.
4. To set your local time, select **LOCAL TIME**, then select **LOCAL TIME ADJUST**.
5. (Optional) To use a 24-hour format, select **LOCAL TIME FORMAT** and then select **24-HOUR**.

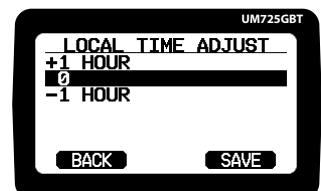
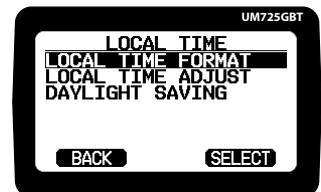
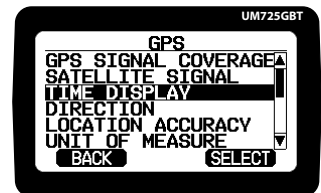

## OPERATING THE RADIO

In order to customize your radio to your specific needs, it is important to understand it's basic operation. Your radio has three main operation modes:

Normal	Scan	Weather
Monitors a single channel and lets you talk on that channel to another radio.	Sequentially checks for transmissions on all channels or channels saved in memory.	Monitors the selected NOAA weather channel. Hear the current or forecasted weather.

### MONITORING A CHANNEL (NORMAL MODE)

To monitor a channel, press either of the **CH** buttons to select the desired channel (press and hold to scroll quickly). The radio will remain on that channel and you will be able to hear any transmissions on that channel.

To save the current channel into memory, press the **MEM** soft key; **MEM** appears on screen for saved channels. (To remove a saved channel from memory, press the **MEM** soft key again.)

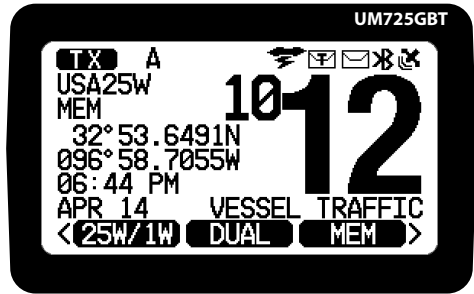

**Tip:** Saving specific channels to memory enables your radio to scan those channels, expanding your ability to listen for transmissions in your area. If you discover that a saved channel has a different common name in your local area, you can change the channel name using the **Radio Setup** menu.

### Setting the Squelch Level

The UM725 recognizes signals as transmissions if they exceed a signal strength threshold that can be adjusted using the squelch. The squelch feature reduces static on the speaker by filtering out any background channel noise.

Increasing squelch requires a signal to be stronger to be seen as a transmission, filtering out noise and letting only actual radio transmissions through. Set too high, you risk missing transmissions lower than the threshold.

Reducing the squelch allows weaker signals to be accepted, but can result in "white noise."

While in Standby mode, press the **PUSH/VOL/SQ** and turn to adjust the squelch.

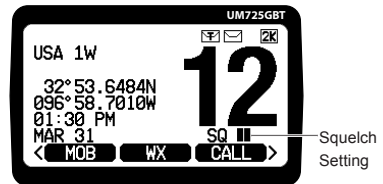
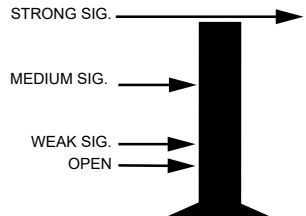

## SCANNING RADIO CHANNELS

Scan Mode sequentially checks channels that you have saved in memory. You must have at least two channels saved in memory to start a scan.

To scan saved channels, press the **MEMSCAN** soft key. To scan all channels, press the **ALLSCAN** soft key.

The radio scans channels according to your radio settings, including Priority and Weather Alert watch, if set. If the radio detects a transmission, it stays on that channel; when the signal stops, the radio resumes scanning. When the radio receives a transmission, it pauses the scan and stays on the transmitting channel. Press **▲** or **▼** to leave that channel and resume scanning.

To end the scan, press the **SCAN** soft key. The radio remains on the last scanned channel.

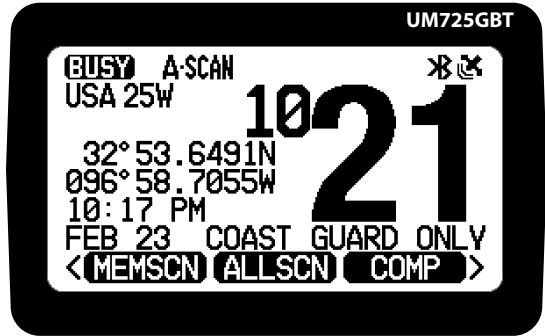
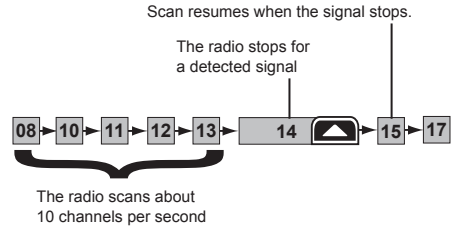

**Tip:** If your radio stops on a transmission during **ALLSCAN**, you may want to save the channel to memory, so that you can easily return to the channel again later or include it when you perform a **MEMSCAN**.

### TO SAVE CHANNELS FOR MEMORY SCAN:

1. Press the **MENU** button on your radio and then use the **PUSH/SEL** knob to access the **SET SCAN CH** menu. The Set Scan CH screen appears
2. From here, you can use the **PUSH/SEL** knob and **▲** or **▼** buttons to select a channel, then press the **SELECT** soft key to toggle the channels on or off for scanning.
3. (Optional) Press **RESET** to turn all channels off.

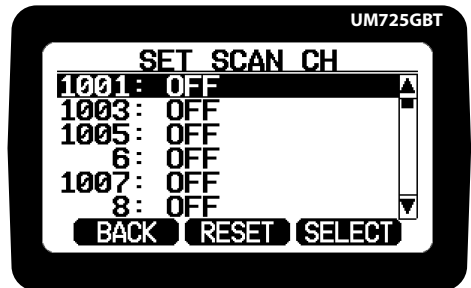

## MONITORING WEATHER CHANNELS

To monitor saved weather channels, press the WX soft key. The radio tunes to one of the 10 NOAA weather channels. If a weather alert signal is received in Weather Alert mode, the radio sounds an alert tone. The NOAA weather channels cooperate with the FCC to alert you of other hazards besides weather.

- You cannot transmit while in Weather mode.
- To turn off the radio's alert tone, press any key.

### TO SET WEATHER (WX) ALERTS:

1. Press the **MENU** button, select the **RADIO SETUP** menu and press **SELECT**. The **RADIO SETUP** menu appears.
2. Select **WEATHER RADIO** and press **SELECT**. The Weather Radio screen appears.
3. Select **WX ALERT** and press **SELECT**. The WX Alert screen appears.
4. Select **ON** and press **SELECT**.

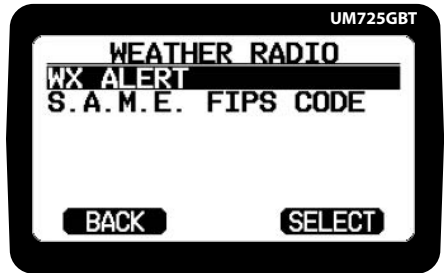
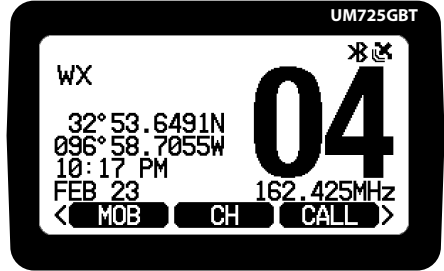

*TO PROGRAM FIPS CODES:*

1. Press the **MENU** button, select the **RADIO SETUP** menu and press **SELECT**. The **RADIO SETUP** menu appears.
2. Select **WEATHER RADIO** and press **SELECT**. The Weather Radio screen appears.
3. Select **S.A.M.E. FIPS CODE** and press **SELECT**. The S.A.M.E. FIPS Code screen appears.

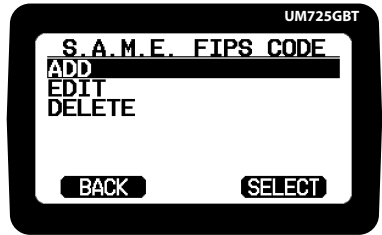

---

**Note:** To modify an existing FIPS code, select **EDIT** in Step 4 and select the name from the list that appears. To delete a FIPS code, select **DELETE**, select the name from the list, and then confirm.

---

4. Select **ADD** and press **SELECT**. The Add FIPS Code screen appears.
5. Use the radio controls to enter the FIPS code.
6. When done, press **SAVE**.



---

**Note:** FIPS codes identify counties in the United States. FIPS codes allow you to receive only the Specific Area Message Encoding (S.A.M.E.) alert occurring in a specific area. You can enter a maximum of 30 FIPS codes. For USA FIPS codes by state, see <http://www.nws.noaa.gov>. For Canadian FIPS codes, see <https://www.ec.gc.ca>.

---

## PRIORITY AND WEATHER ALERT WATCH

In addition to the three operation modes, your radio provides two watch functions that set the radio to quickly and regularly check for activity on specific channels.

- ◆ Priority Watch – Checks 1-2 designate Priority channels for activity every two seconds.
- ◆ Weather Alert Watch – Checks the weather channel for alerts every seven seconds.

### Priority Watch

Your radio comes with a preprogrammed Priority channel. Your radio will function normally, and will also check the Priority channel(s) every two seconds. If the radio detects a transmission, it will stay on that channel; when the signal stops, the radio resumes scanning. To activate Priority Watch, press the **TRI** (or **DUAL**) soft key.

---

**Note:** Private ships must monitor channel 16 whenever they are underway. Water-going ships should have a Priority Watch on at all times.

---

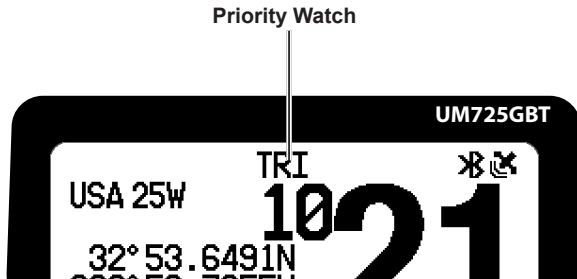

### During Normal Mode

Monitors one channel, checking channel 16 and the Priority channels every 2 seconds.

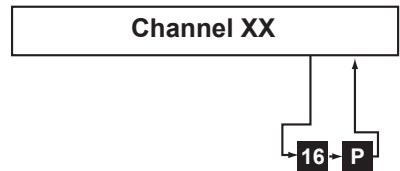

### During Scan Mode

Scans multiple channels, checking channel 16 and the Priority channels every 2 seconds.

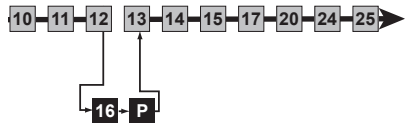

### During Weather Mode

Monitors a weather channel, checking channel 16 and the Priority channels every 2 seconds.

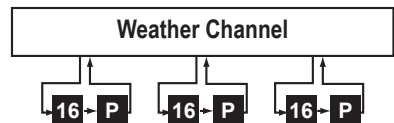



## Weather Alert Watch

When Weather Alert Watch is active, your radio will function normally, and will also check the most recent weather channel every seven seconds. If the radio detects a transmission, it will stay on that channel; when the signal stops, the radio resumes scanning.

To activate Weather Watch, press the **MENU** button, and then use the **PRESS/SEL** knob to access the **RADIO SETUP/WEATHER RADIO** menu. Access the **RADIO SETUP** menu and **WEATHER RADIO** submenu.



### During Normal Mode

Monitors one channel, checking weather channel every 7 seconds.

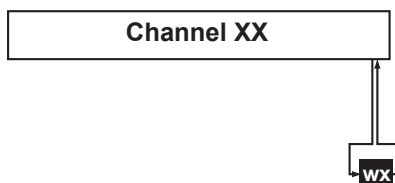

### During Scan Mode

Scans multiple channels, checking weather channel every 7 seconds.

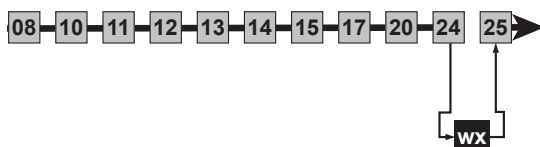

### During Weather Mode

While in Weather mode, the Weather Alert function operates as a type of “sleep mode.” The radio stays on the weather channel and mutes the speaker, and if the radio detects an alert, it sounds an alert tone, switch to that weather channel, and turns the speaker back on. This function is useful if you anchor for the night but want to keep informed of hazards.

To activate both Weather Alert Watch and Priority Watch at the same time, activate Weather Alert watch using the **RADIO SETUP/WEATHER RADIO** menu, and then while scanning, press the **DUAL** (or **TRI**) soft key.

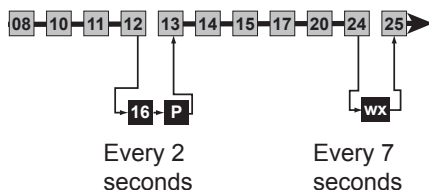

# DIGITAL SELECTIVE CALLING (DSC)

## WHAT IS DSC?

Digital Selective Calling (DSC) is a standard that allows you to quickly and easily call specific radios or groups of radios using their unique MMSI (Maritime Mobile Service Identity) number. The four basic call types are:

- Distress Calls – Use in emergencies only! The Distress message alerts all ships that you need assistance and sends your current position.
- Individual Calls – Calls a single station using the User MMSI. Use when you want to talk to another station
- Group Calls – Calls all ships with the same Group MMSI. Use to talk with your whole group at the same time.
- All Ships Calls – Calls all ships within range of your radio. Should only be used for safety warnings (e.g., debris in the water) or urgent situations.

## HOW DOES DSC WORK?

The DSC standard dedicates a VHF channel—channel 70—to digital transmissions only. Because digital transmissions require less bandwidth than voice transmissions, channel 70 avoids the problems of busy voice channels. The radio uses channel 70 to transmit your MMSI number to the other station along with a voice channel.

If the other station accepts your call, both radios automatically switch to the requested voice channel so you can talk to the other station.

DSC also provides a system for automated distress calls. At the touch of a key, the radio can transmit your MMSI number, the nature of your distress, and your current position based on data from your GPS receiver. The radio repeats the distress call every few minutes until it receives an acknowledgement. Much like familiar "contacts" and "group text" functions of modern phones, your UM725 lets you save individual contacts in your Individual Directory and groups in your Group Directory.

Suppose you are coordinating safety for a sailboat race. Before the race starts, you use your radio to instruct all the racers to enter your group MMSI number into their radios. During the race:

- Throughout the race, you use group calling to update the racers on the time, race status, and any course corrections.
- A power boat full of spectators comes too close to the race path. You use individual calling to contact the power boat and advise them to stay clear of the race.
- You see a rowboat entering the area, but since it doesn't have a radio, you can't communicate with the rowboat. You use all ships calling to alert all the other ships in the area of the possible danger.

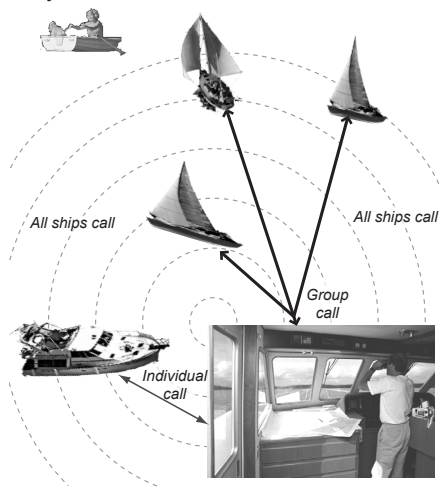

## MANAGING DSC SETTINGS

Even though you can change your DSC settings, as needed, you will probably want to establish initial settings.

1. Press the **MENU** button, select the **DSC SETUP** menu and press **SELECT**. The **DSC SETUP** menu appears.
2. From here, you can use the **PUSH/SEL** knob and **▲** or **▼** buttons to access and customize DSC settings for your radio:

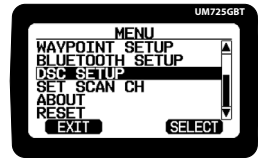

- **RADIO MMSI NUMBER** – Displays your MMSI number.
- **CURRENT POSITION** – Displays your current position. You can set your current position manually, but manual information will be overwritten by GPS data if available.
- **INDIVIDUAL DIRECTORY** – Manages individual MMSI numbers for making calls.
- **GROUP DIRECTORY** – Manage MMSI groups for making calls.
- **INDIVIDUAL REPLY** – Select **AUTO** or **MANUAL** for replies to calls. The screen displays:
  - Individual Call ACK
  - Position Request ACK
  - Test Call Ack
- **INDIVIDUAL ACK** – Select **AUTO** or **MANUAL** request acknowledgements.

---

**Note:** Automatic acknowledgement automatically transmit your current position in response to position requests. Most boaters activate automatic position reply for safety reasons or because they subscribe to a marine towing service. Sometimes—for example, in some competitive situations—you may not want other ships to get your position without your manual confirmation.

---

- **INDI CALL RING** – Sets how long the alarm will sound for individual calls: 5, 10, or 15 sec, or 1 or 2 minutes.
- **WAIT FOR POS FIX** – Sets how long the radio will wait for position fix requests: 15, 30, or 45 sec, or 1, 2, or 5 minutes.
- **AUTO POLLING TIME** – Sets how long the radio will wait for auto-polling requests: 30 sec, or 1, 2, 3, or 5 minutes.
- **AUTO POS POLLING** – Set how long the radio will wait for auto position fix requests.
  - **AUTO POS REQUEST** – Request positions from other individuals
  - **AUTO POS REPORT** – Report your position to other individuals.
- **DSC ALARM SETUP** – Turn alarms on and off for specific call types.

---

**Note:** You cannot turn off alarms for Distress call types.

---

## SETTING UP DSC INDIVIDUALS AND GROUPS

Much like traditional contacts in a phone, DSC directories lets you store up to 100 individual MMSI numbers of other ships and 50 group MMSI numbers. From the directories, you can add, edit or delete MMSI numbers.

### TO MANAGE INDIVIDUAL DIRECTORY:

1. Press the **MENU** button, select the **DSC SETUP** menu and press **SELECT**. The **DSC SETUP** menu appears.
2. Select **INDIVIDUAL DIR** and press **SELECT**. The Individual Dir screen appears.
3. Select **ADD** and press **SELECT**. **NAME** and **MMSI** appear on the screen.

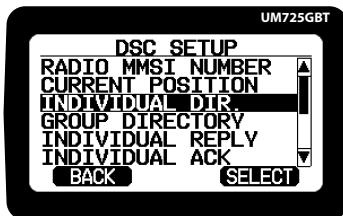

**Note:** To modify an existing individual, select **EDIT** in Step 3 and select the name from the list that appears. To delete an individual from your directory, select **DELETE**, select the individual, and then confirm.

4. Select **NAME** and press **SELECT**. The pop-up keyboard appears.

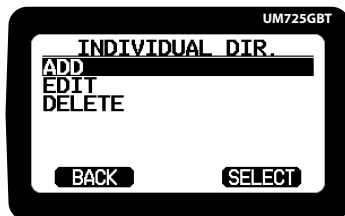

5. Use the keyboard to enter a name for the individual. When done, press **FINISH**. The Individual Dir screen displays again.



6. Select **MMSI** and press **SELECT**.
7. Use the radio controls to enter the MMSI number.
8. Press **FINISH**. The Individual Dir screen displays again.
9. To save this MMSI number and name, select **SAVE**.

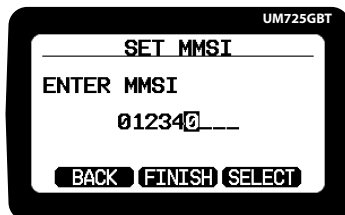

### TO MANAGE A GROUP DIRECTORY:

Unlike the user MMSI number, you can create a group MMSI number yourself, and You can also change the group MMSI number as often as you want. You don't have to get a group MMSI number from a specific organization. For example, if you are part of a boating club, your club's leadership may have a list of approved group MMSI numbers to use.

1. Press the **MENU** button, select the **DSC SETUP** menu and press **SELECT**. The **DSC SETUP** menu appears.
2. Select **GROUP DIRECTORY** and press **SELECT**. The Group Directory screen appears.
3. Select **ADD** and press **SELECT**.The Add Group Dir screen appears.

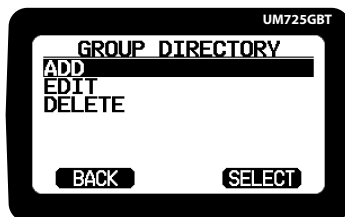

**Note:** To modify an existing group, press **EDIT** in Step 3 and select the group name from the list that appears. To delete a group from your directory, select **DELETE**, select the group, and then confirm.

4. Press **SELECT**. The pop-up keyboard appears.
5. Use the keyboard to enter a name for the group. When done, press **FINISH**. The Group Directory screen displays again.
6. Select **MMSI** and press **SELECT**.
7. Use the radio controls to enter the MMSI number for the group.

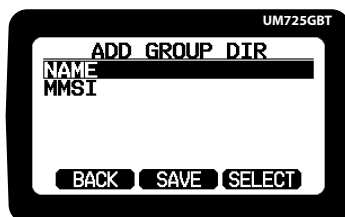

**Note:** The Group MMSI number must have 9 digits and the first digit of a group MMSI is fixed at "0."

8. When done, press **FINISH**. The Group Directory screen displays again.
9. To save this MMSI number and name, select **SAVE**.

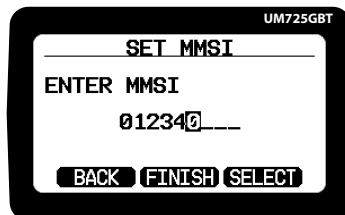

## DSC CALLS

### TO CALL AN INDIVIDUAL STATION:

1. Press the **CALL** soft key. The **CALL** menu appears.
2. Use the **PUSH/SEL** knob to select **INDIVIDUAL CALL**. The Select ID screen appears with the list of your saved stations.
3. Use the **PUSH/SEL** knob to select the station that you want to call. The radio displays selected ship's MMSI and the transmission channel.
4. Use the **PUSH/SEL** knob to select the channel.
5. You can switch between inter ship channels and all voice channels by pressing the **MANUAL** soft key.
6. Press **SEND**. The radio transmits the call request on the selected channel. When the other station accepts the call, both radios switch to the selected response channel for voice transmission.
7. If the other station does not respond, press **RESEND** or **EXIT**.

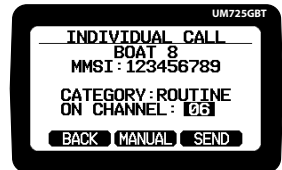
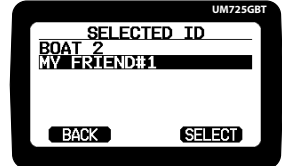
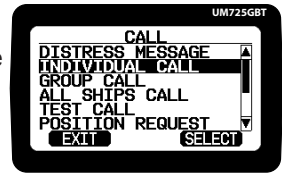

### TO CALL A GROUP:

1. Press the **CALL** soft key. The **CALL** menu appears.
2. Use the **PUSH/SEL** knob to select **GROUP CALL**. The Group Call screen appears with the list of your saved groups.
3. Use the **PUSH/SEL** knob to select the station or group that you want to call. The radio displays selected group's MMSI and the transmission channel.
4. Press **SEND**. The radio transmits the call request on the selected channel. When a station accepts the call, both radios switch to the selected response channel for voice transmission.
5. If another station does not respond, press **RESEND** or **EXIT**.

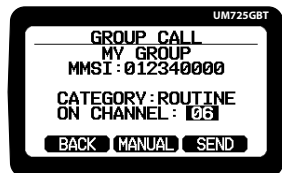
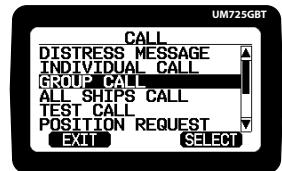

**TO CALL ALL-SHIPS:**

All-ships calls *contact all DSC radios within range of your ship. Only use all-ships calling in the event of a Safety warning (such as debris in the water) or to request assistance in an Urgency (any situation where your ship has a serious problem but is not yet in distress).*

1. Press the **CALL** soft key. The **CALL** menu appears.
2. Use the **PUSH/SEL** knob to select **ALL SHIPS**. The All Ships Call screen appears, showing two options: **SAFETY** and **URGENCY**.
3. Use the **PUSH/SEL** knob to select either option and then enter the channel to transmit on. Press **SEND**. The next screen displays the type of All Ships Call sent, the channel the call was sent on, and a countdown clock. If the radio receives an acknowledgement, it automatically switches to the designated response channel.
4. If the countdown clock ends, your radio will generate another countdown clock. You can either resend or cancel the call.

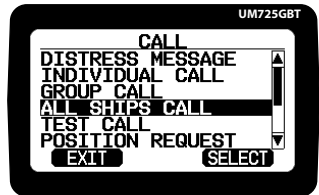
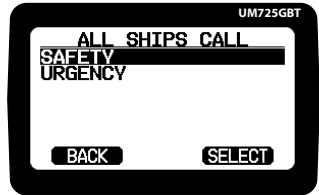
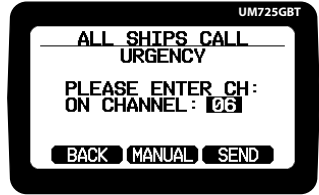

**TO RESPOND TO CALLS (INDIVIDUAL/GROUP/ALL SHIP):**

If your radio receives a DSC call from another station, it sounds an incoming call alarm and displays the MMSI number of the calling station or group and the transmitting channel for the call.

---

**Note:** This radio does not have the ability to acknowledge a distress call. Only the Coast Guard or an authorized Search and Rescue agency can acknowledge a DSC distress call.

---

1. Press the **STOP ALARM** soft key to stop the alarm. The radio will return to the main screen with the channel selected.
2. To speak to the other ship, press and hold the **Push to Talk** key on the microphone while talking. When you are finished talking, release the **Push to Talk** key to listen for a response.

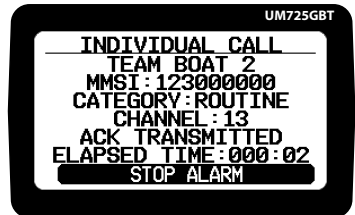

## TO AUTOMATICALLY RESPOND TO CALLS

When another station sends you a range of calls, including test calls and position requests, you can select options to answer those calls manually or have the radio answer automatically.

1. Press the **MENU** button, select the **DSC SETUP** menu and press **SELECT**. The **DSC SETUP** menu appears.
2. Select **INDIVIDUAL REPLY** and press **SELECT**. The Individual Reply screen appears.
3. For each type of call received (Individual, Position Request, or Test), you can select the call type and press **SELECT**.
4. Use the **PUSH/SEL** knob to select **AUTO**

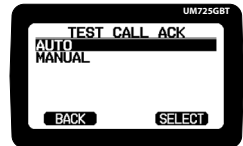
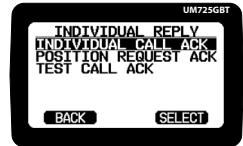
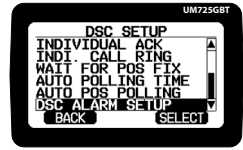

## TO MAKE A TEST CALL:

You can use the test call feature to make sure your radio is working and configured correctly. To avoid overloading coastal receiving stations, you should limit test calls to these stations to once a week.

---

**Note:** Many coastal stations have specific frequencies and MMSI numbers you should use for making test calls. Before making a test call to a coastal station, be sure to check the Local Notice to Mariners (LNM), issued every week by the US Coast Guard. The LNM for each region are available online at <http://www.navcen.uscg.gov>.

---

1. Press the **CALL** soft key. The **CALL** menu appears.
2. Use the **PUSH/SEL** knob to select **TEST CALL**. The list of ships from your Individual Directory appears.
3. Use the **PUSH/SEL** knob to select a ship. Information for the selected station appears.
4. Press **SEND**. A WAITING FOR ACK message displays on the **TEST CALL** screen. If you do not receive an acknowledgement, either resend the transmission or select **BACK** to return to the Idle screen.

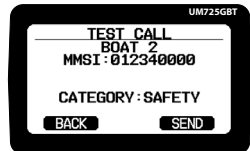
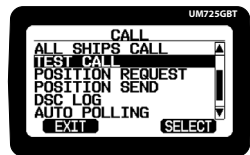



## DSC CALL LOGS

Your radio keeps track of the last 50 transmitted calls and the last 50 received in the DSC Log. If you have unread received DSC calls, the radio displays a Message icon. This is useful if you have been away from your radio and want to see who has tried to contact you.

1. Press the **CALL** soft key. The **CALL** menu appears.
2. Use the **PUSH/SEL** knob to select **DSC LOG**. The DSC Log screen appears, showing two call logs: **TRANSMITTED LOG** and **RECEIVED LOG**.

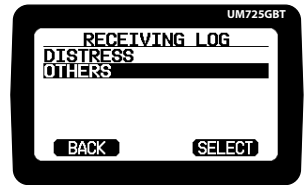

3. Press **TRANSMITTED LOG** or **RECEIVED LOG** to see the last 50 calls of either log. Calls are listed in the order they were received, with the newest call shown first. New, unreviewed call blink on the screen.
4. Use the **PUSH/SEL** knob to select a call and review the call details. Information varies, depending on call type.

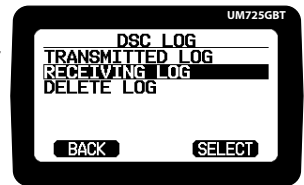

DSC Call Type	Receive Log Information
Distress	MMSI (or name), position, time, nature code.
Distress Acknowledge	MMSI (or name), distress MMSI, position, time, nature code.
All Ships	MMSI (or name), category code, communication channel number.
Group	MMSI (or name), category code, communication channel number.
Individual	MMSI (or name), category code, communication channel number.
Individual Acknowledge	MMSI (or name), Completed/Unattended, category code, communication channel number.
Test	MMSI (or name), category code.
Test Acknowledge	MMSI (or name), category code.
Pos Reply	MMSI (or name), position, time, category code.
Pos Request	MMSI (or name), category code.
Pos Send	MMSI (or name), position, time, category code.

5. To make a call from the call log, press the **CALL** soft key on the log screen.
6. To delete entries in a specific log, press **DELETE LOG**.
7. To close the log, press **EXIT**.

## MAKING A TRANSMISSION

To transmit while in any mode, select the channel you want to transmit on, and then press and hold the **Push-to-Talk** key on the microphone while talking. When you are finished talking, release the **Push-to-Talk** key to listen for a response.

- For the best sound quality, hold the microphone about two inches away from your mouth.
- To prevent stuck microphone problems or situations where the **Push-to-Talk** key is pushed accidentally, the radio limits your talk time to 5 minutes in a single transmission.

In most situations, 1W transmission power is all you need. If you are far away from other ships, you may need to increase the transmission power.

To change the power level for the current channel transmission, press the **H/L** soft key. The TX output power changes from 25W to 1W, then back again to 25W. The transmit power remains at the new setting on that channel until you change it again.

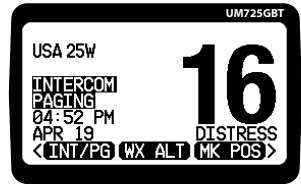
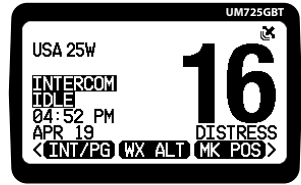

---

**Note:** Some channels (for example, channels 13 and 67) limit the transmission power to 1W. If you try to change transmission power output but the channel is only 1W, the radio sounds an error tone and stays at 1W.

---

### TO USE THE INTERCOM:

Your radio's intercom function allows you to communicate hands free in order to respond to an incoming transmission (requires a connected UMRMIC):

1. Press the **INTCOM** soft key. The radio displays INTERCOM IDLE.
2. To page the other party press and hold the **INTCOM** soft key. The radio displays INTERCOM PAGING and will send the page tone (two beep tones) to the other party.

## POSITION REQUESTS

### TO MAKE A POSITION REQUEST:

Any time you need to know where another ship currently is—to find your boating partners, to respond to a request for assistance, etc.—you can send a position request to their radio.

1. Press the **CALL** soft key. The **CALL** menu appears.
2. Use the **PUSH/SEL** knob to select **POSITION REQUEST**. The Position Request screen appears, showing the list of ships you entered into the Individual directory.
3. Use the **PUSH/SEL** knob to select a ship and press **SELECT**. The Position Request screen displays for confirmation.
4. Press **SEND**. The radio sends out a position request to that ship and waits for acknowledgement. If you do not receive an acknowledgement, press **BACK** to return to the Idle screen.

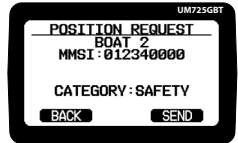
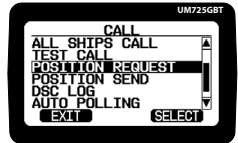

### TO SEND YOUR POSITION:

If you are requesting assistance, using an all ships call, or have received a Position Request, you can send your current position so other ships know where you are:

1. Press the **CALL** soft key. The **CALL** menu appears.
2. Use the **PUSH/SEL** knob to select **POSITION SEND**. The Position Send screen appears, showing the list of ships you entered into the Individual directory.
3. Use the **PUSH/SEL** knob to select a ship (If you want to contact a station that is not in your directory, press **MANUAL** and enter the MMSI number you want to call.).
4. Press **SELECT**. The radio displays the name and MMSI number of the station you are about to contact along with your current position information.
5. Press **SEND**. The radio transmits your current position information to the other station.

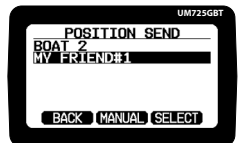
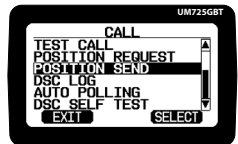

### SENDING TEXT MESSAGES:

To send a text message, you must save the other party's information (MMSI) in the Individual Directory. See "To Manage Individual Directory:" on page E-24.

1. Press the **TEXT** soft key and select **NEW MESSAGE**. Your list of DSC contacts appears.
2. Use the **PUSH/SEL** knob to select an individual contact to send a message. A pop-up keyboard screen appears.
3. Enter your text message. When complete, press the **FINISH** soft button. The TX Message screen appears.
4. Press the **SEND** soft key.
5. To review sent and received messages, press the **TEXT** soft key and select **RX MESSAGE** (received) or **TX MESSAGE** (sent),

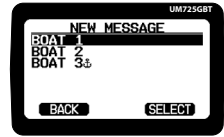
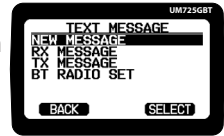

### TO USE AUTO POLLING:

Auto Polling lets you request an automatic position update from up to 7 individuals. You can also send your position automatically to up to 7 individuals.

1. Press the **CALL** soft key. The **CALL** menu appears.
2. Use the **PUSH/SEL** knob to select **AUTO POLLING**. The Auto Polling screen appears.
3. Press **SELECTED ID**. The Select ID screen appears.
4. Use the **PUSH/SEL** knob to select a row and press **SELECT**. The Select ID screen displays your saved Individual Directory list.
5. Use the **PUSH/SEL** knob to select a ship and press **SELECT**. The Select ID list displays again with that contact listed.
6. Repeat steps 4-5 for up to 7 contacts.
7. Press **BACK**.
8. Use the **PUSH/SEL** knob to select **ACTIVATION** and press **SELECT**. The Activation screen appears.
9. Use the **PUSH/SEL** knob to select **START** to begin or **STOP** to end auto polling. An "A" icon will appear on the screen when Auto Polling is started. See "Reading the Radio Screen" on page E-9.

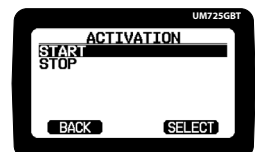
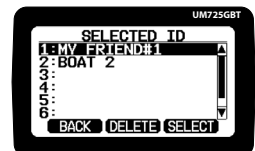
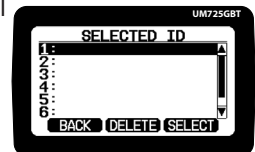
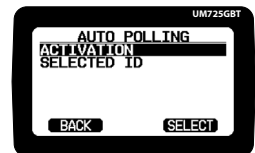
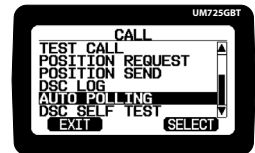

## DSC SELF TEST

Perform a DSC self-test. If you get a FAIL, please contact Uniden Customer Service. See "DSC Calls" on page E-26.

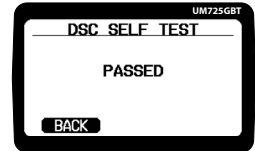

## RECEIVING A DISTRESS CALL

If you receive a distress call, your radio will sound Distress Call Tone and display Name (or MMSI), Distress Message, Latitude, Longitude, Time, Elapsed Time for the vessel that sent the Distress Call. Press any key to stop Distress Call Tone.

If there is data that matches an MMSI in your individual directory, the name is displayed, otherwise the MMSI is displayed.

1. Press the **STOP ALARM** soft key.
2. PRESS the **ACCEPT** soft key to plot a waypoint to the location data in the distress call. The WPT screen appears.
3. Press the **SAVE** soft key to save the coordinates as a waypoint.
4. Press the **NAVI** soft key to start Navigation to the vessel that sent the Distress Call.

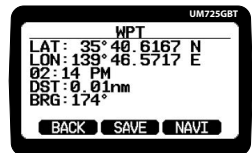
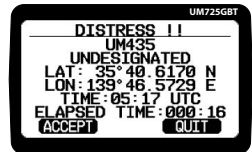
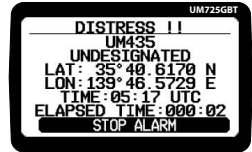

## MAKING AN AUTOMATIC DISTRESS CALL

After you have programmed your MMSI number, your radio can transmit an automated distress call on channel 16 at 25W with your current location and nature of the distress. The Distress Alert alarm sounds and the radio then monitors channel 16 for a response and repeats the distress call every few minutes until it receives an acknowledgement.

1. If you have time to selected a distress message type, press the **MENU** button and use the **PUSH/SEL** knob to select **DISTRESS MESSAGE**. The Distress Message screen appears.
2. Use the **PUSH/SEL** knob to select the emergency type that most closely matches the nature of your emergency. The screen returns to the Main menu.

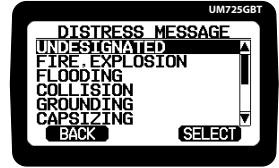

Undesignated	Sinking	Fire, Explosion	Man Overboard
Adrift	Flooding	Abandoning Ship	Capsizing
Collision	Piracy	Grounding	

3. Press and hold the **DISTRESS** key on the side of the radio for about 3 seconds. The Distress Alert alarm sounds and the radio acquires GPS location if needed.
4. After 10 seconds, the radio transmits the distress call, starts a countdown timer, and

---

**Note:** If no MMSI number has been programmed, the radio prompts you to enter your MMSI number.

---

waits for an acknowledgement. After the timer counts down, another countdown timer begins unless you take action using the **PAUSE**, **CANCEL**, or **RESEND** soft keys).

5. After you receive an acknowledgement that the distress call was received, use the **MUTE** soft key to stop the acknowledgement alarm.

### **MOB Soft Key**

The Man Overboard (**MOB**) soft key does not require setup through the menus. Your radio immediately displays and saves the latitude, longitude, time, Bearing to Destination (BRG), and Distance to Destination (DIST).

1. Select the **MOB** soft key and the screen automatically marks your current location as Man Overboard. The soft keys change to **BACK**, **SAVE**, and **NAV**.
  - Select **BACK** to return to the previous mode and keep the current MOB information.
  - Select **SAVE** to save the location.
  - Select **NAV** to activate the COMPASS screen and navigate to the destination.

## SETTING UP BLUETOOTH (UM725GBT ONLY)

Uniden's Marine Radio app (Uniden Marine II) lets you configure your UM725GBT and send text messages from your mobile phone (available for Android and iOS).

1. Press the **MENU** button, then use the **PUSH/SEL** knob to select **BLUETOOTH SETUP**. Press the **PUSH/SEL** knob again, and the BLUETOOTH SETUP submenu appears.
2. (Optional) To change your radio's name, use the **PUSH/SEL** knob to select **FRIENDLY NAME** and then use the keyboard screen to set the name.
3. Use the **PUSH/SEL** knob to select **BT RADIO** and then activate Bluetooth.
4. Open the Uniden Marine app on your device and follow the on-screen instructions.
5. In the app, press **Search**. The Searching screen appears, followed by a list of available radios.
6. Press your radio's name when it appears. If it does not appear, move your device closer to the radio and try again.
7. Once paired, you will be able to review your contacts and text messages (received and sent), and to send messages to your radio contacts.

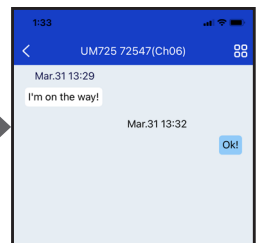
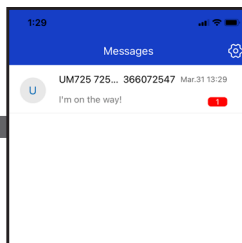
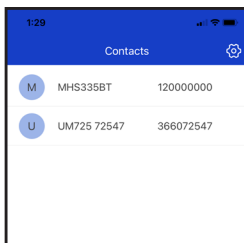
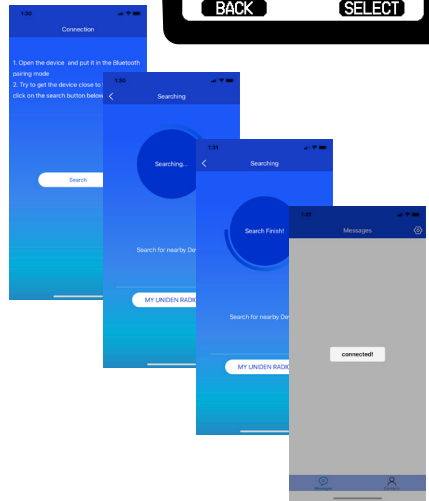
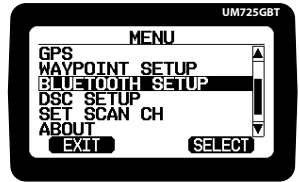

## GPS FEATURES

To view satellite coverage, press the **MENU** button and use the **PUSH/SEL** knob to access the **GPS** menu and then **GPS SIGNAL COVERAGE**. The GPS Signal Coverage screen shows satellite coverage: black dots = active satellites, white dots = inactive satellites.

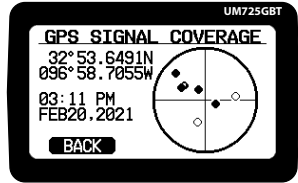

To view satellite signal strength, select **SATELLITE SIGNAL** from the **GPS** menu. This will display a chart indicating satellite number and signal strength.

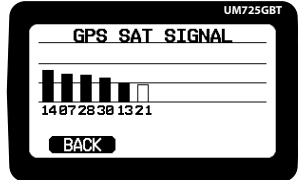

### TO CONFIGURE YOUR GPS:

Your GPS system is able to provide more than just your specific location. It provides several customizable features to help you get much more from your radio. Depending on your radio model and your navigation system, some options in your GPS menu will vary.

1. Press the **MENU** button, and then use the **PUSH/SEL** knob to access the **GPS** menu.
2. From this menu, you can use the **PUSH/SEL** knob to access and customize GPS settings for your radio:

- **TIME DISPLAY** – Choose between local time or UTC (UCT/GMT), and 12-hour or 24-hour display. See "Time Settings" on page E-15.
- **DIRECTION** – Course Up (oriented by your course direction) or North Up (oriented to compass north).
- **LOCATION ACCURACY** – Location in degrees (DDD), minutes (mm), and seconds (ss), or DDD.mm.mmm.
- **UNIT OF MEASURE** – Set Speed (Knots, MPH, or KM/H), and Distance (Nautical Mile, Staute Mile, or Kilometer) as the radio's unit of measure.
- **STATIONARY POSITION** – On/Off. When turned on, if the ship is not moving, the displayed location information is fixed.
- **NMEA INPUT PRIORITY** – Designates which received position data has priority if more than one source is active: **NMEA0183** or **NMEA2000** (UM725GBT / UM725G models only).

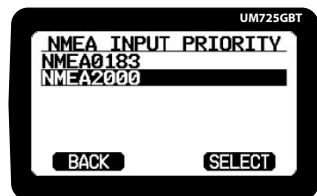
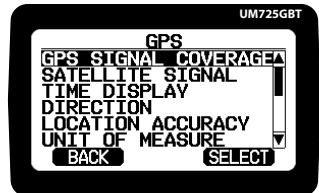

---

**Note:** The internal GPS receiver is always set as lowest priority.

---



- **POS DATA OUTPUT** – Designates the port for position data output: **NMEA0183** or **NMEA2000** (UM725GBT / UM725G models only)
- **NMEA0183 OUTPUT** – Select what NMAE data is sent (UM725GBT/UM725G models only).
- **NMEA0183 DATA SPEED** – Select which NMEA data speed to use (4800 pbs or 38400 pbs).
- **NMEA2000 SETUP** – Search for a connected NMEA 2000 device (UM725GBT / UM725G models only).
- **INTERNAL GPS** – Lets you search for a connected NMEA2000 device, turn internal GPS module power on or off, activate D-GPS, and select an internal or external antenna. D-GPS is a means of correcting GPS variances, and should be turned off in the southern hemisphere. (UM725GBT / UM725G models only)

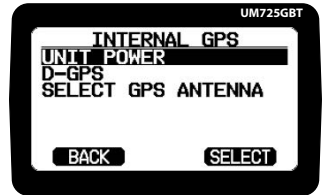

# NAVIGATION

## WAYPOINTS AND ROUTES

You can search the internet for latitude and longitude for the location you want. For example, search for "Key West Naval Hospital coordinates."

You can save up to 250 waypoints in your Waypoint Directory. You can also use the position stored in **MK POS** and **MOB**.

### TO SET UP A WAYPOINT:

1. Press the **MENU** button, and then use the **PUSH/SEL** knob to access the **WAYPOINT SETUP** menu. From this menu, you can use the **PUSH/SEL** knob to define waypoints for your radio:
2. Select **WAYPOINT DIRECTORY** and press **SELECT**. The Waypoint Setup screen appears.
3. Select **ADD** and press **SELECT**. **NAME**, **LAT**, and **LONG** appear on the screen.

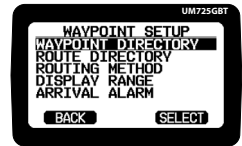

**Note:** To modify an existing waypoint, select **EDIT** in Step 3 and select the waypoint name from the list that appears. To delete a waypoint from your directory, select **DELETE**, select the waypoint, and then confirm.

4. Use the **PUSH/SEL** knob to select **NAME** and press **SELECT**. The pop-up keyboard appears.
5. Use the keyboard to enter a name for the waypoint. When done, press **FINISH**. The Waypoint Setup screen displays again.
6. Select **LAT** and press **SELECT**, then use the keyboard to enter the latitude for the waypoint.
7. When done, press **FINISH**. The Waypoint Setup screen displays again.
8. Select **LON** and press **SELECT**, then use the keyboard to enter the longitude for the waypoint.
9. Press **SAVE**.

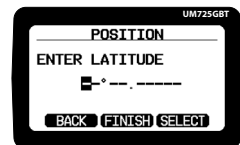
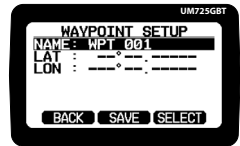

*TO SET UP A ROUTE:*

1. Press the **MENU** button, and then use the **PUSH/SEL** knob to access the **WAYPOINT SETUP** menu.
2. Use the **PUSH/SEL** knob to select **ROUTING METHOD** and press **SELECT**. If set to **AUTO**, the screen automatically changes to the next destination. If set to **MANUAL**, navigation will not start until you press **NEXT**.
3. Select **ROUTE DIRECTORY** and press **SELECT**. The Route

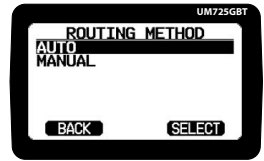

**Note:** These settings cannot be set or changed during navigation. To make any changes, first exit navigation mode.

Directory screen displays a list of available routes.

4. Use the **PUSH/SEL** knob to select a route and press **EDIT**. **NAME** and **LIST** appear on the screen.
5. Use the **PUSH/SEL** knob to select **NAME** and press **SELECT**. The pop-up keyboard appears.
6. Enter a name for the waypoint. When done, press **FINISH**. **NAME** and **LIST** appear on the screen again.
7. Select **LIST** and press **SELECT**, The Rout List screen appears.
8. Press the **ADD** soft key. The Point List screen appears with a list of saved waypoints.
9. To add a waypoint, use the **PUSH/SEL** knob to select the waypoint and press **ADD**.
10. Repeat step 8-9 for each waypoint you want to add to the route.

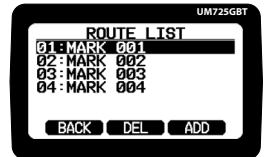
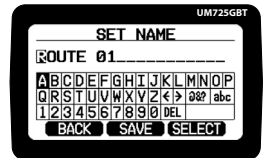
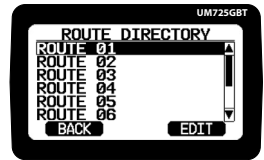

**Note:** The Waypoint selected for the 01 position will be the first point to which your radio will navigate. When you reach that waypoint, the radio will navigate to the next waypoint (02), and continue through the list of waypoints.

11. Press **BACK** to exit.

## ACCESSING NAVIGATION

When you press the **NAVI** soft key and the following two menus will appear.

- **WAYPOINT DIRECTORY** – Displays your waypoint directory for access or editing. This list also includes information saved by MOB and MK POS keys (MOB appears as MOB 001, 002... MK POS appears as MARK 001, 002... if they were saved without being edited.)
- **ROUTE DIRECTORY** – Displays your route directory for access or editing.

### TO START WAYPOINT NAVIGATION.

1. Select **WAYPOINT**. The WAYPOINT DIRECTORY appears.
2. Select the desired waypoint and press the **GOTO** soft key to start navigating to your destination.

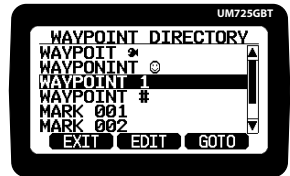
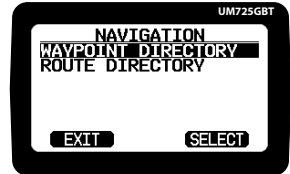

---

**Note:** Navigation cannot be started without the location information from GPS. You can operate radio during navigation, but you cannot edit or change location information (destination or route) during navigation.

---

3. As you navigate, the screen displays your position information.

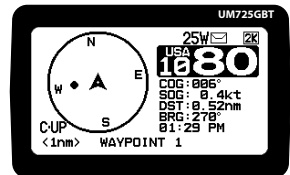

4. When you arrive at destination, an arrival message will be displayed and the arrival alert will sound. You can select whether to continue or end navigation by pressing the **END** or **CLEAR** soft keys.

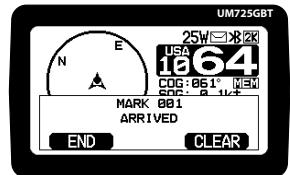

If you press the **CLEAR** soft key, navigation will continue, and once you go out of range and return to the range, the arrival message will be displayed and arrival alert will sound again.

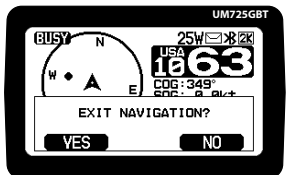

---

**Note:** You can stop navigation anytime by pressing the CLEAR button.

---

## TO START ROUTE NAVIGATION.

1. Select **ROUTE**. The ROUTE List appears.
2. Select the desired route and press the **GOTO** soft key to start navigating to your first destination.
3. You can skip the destination by pressing the **NEXT** soft key.
4. When you arrive at your first destination, the arrival alert will sound.

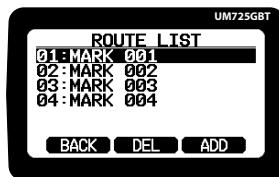

- If the Routing Method is set to **MANUAL**, navigation to the next destination will not start unless you press the **NEXT** soft key each time you reach each destination.
  - If the Routing Method is set to **AUTO**, navigation to the next destination will automatically start after arriving at your first destination. See "To Set Up a Route:" on page E-39.
5. When you arrive at destination, an arrival message will be displayed and the arrival alert will sound. You can select whether to continue or end navigation by pressing the **END** or **CLEAR** soft keys.

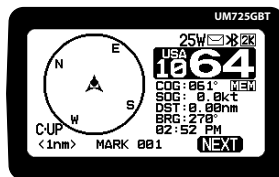

If you press the **CLEAR** soft key, navigation will continue, and once you go out of range and return to the range, the arrival message will be displayed and arrival alert will sound again.

## PARAMETER SETTINGS.

You can select the compass display range and whether the compass display is based on the Cause or the North using the GPS settings. The distance at which the navigation system determines that the ship has arrived at its destination can be customized in the GPS settings. For more information see "To Configure Your GPS:" on page E-36.

A dot representing the destination appears on the screen. If the distance to the destination exceeds the display range (indicated by the dot reaching the circle's edge) you will need to adjust the display range manually or set the GPS to **AUTO**.

When set to **AUTO**, the range will change automatically adjust as needed to keep the destination on screen.

When navigating, the screen displays the following information:

- COG – Cause over ground
- SOG – Speed over ground
- DST – Distance
- BRG – Bearing
- 01:29 PM – Current time
- Destination – Indcated by a dot in the compass
- C-UP – Cause UP (N-UP – North UP)
- Display Range (Distance from Center) – <1nm>
- Destination – "WAYPONT 1"

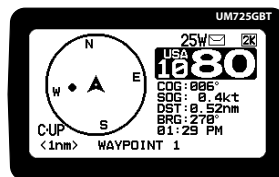

## NMEA OPERATION

Your radio supports NMEA 0183 (version 4.10), a standard for data communication between marine instruments. NMEA sentences contain different sets of data related to your ship. When your radio receives another boat's position data in a DSC call, the radio sends the position data to the chartplotter so you can see the location:

Additionally, the UM725GBT and UM725G models provides a NMEA 2000 port for connecting to GPS along with the standard NMEA0183. See "NMEA2000 PGN LIST (UM725GBT / UM725G ONLY)" on page E-55.

### NMEA0183 INPUT

The UM725 supports the following sentences:

DATA	RMC	GLL	GNS	GGA	ZDA
UTC Time	O	O	O	O	O
Status (Valid/Invalid)	O	O	O	O	X
Latitude/Longitude	O	O	O	O	X
Speed	O	X	X	X	X
Course	O	X	X	X	X
Date	O	X	X	X	O

X = Data Not Provided

O = Data Provided

When the radio receives a DSC call (Distress, Position Reply, or Position Send), it outputs a DSC/DSE sentences from the NMEA output port in the following formats:

- \$CDDSC,12,3081234000,,07,00,0354013946,0657,,,S,E\*6D
- \$CDDSE,1,1,A,3081234000,00,60875646\*13

If some sentences are received (ex. RMC and GLL), the radio use the information based on the following priority order.

- Status: RMC > GLL > GNS > GGA
- Latitude/Longitude: RMC > GLL > GNS > GGA
- UTC Time: RMC > GLL > GNS > GGA > ZDA
- Date: RMC > ZDA
- Speed / Course: RMC

1) For example, if th e radio received only GLL sentence, the radio cannot display speed, course, and date.

2) For example, if both RMC and GLL sentence, the radio will use information of RMC sentence. Status data is used to check which the GPS data is valid or invalid.

The radio supports RMC, GLL, GNS, GGA and ZDA sentence. When these sentences were received, the radio displays latitude/longitude, date, time, course, and speed. Each sentence includes the following information.

## POSITION DATA OUTPUT

NMEA DATA OUTPUT(UM725GBT/UM725G Models only. - Designates the port for NMEA data output.

NMEA0183 OUTPUT- Select NMEA sentence to sent.

NMEA0183 Data speed To set which NMEA data output speed to use (4800pbs or 38400pbs)

If your NMEA device does not initially receive data from your radio, check the accessory cable connection, parameters on the NMEA0183 DATA OUTPUT and NMEA DATA SPEED.

(UM725GBT/UM725G Models Only)

Make sure that NMEA0183 is ON in the POS DATA OUTPUT menu.

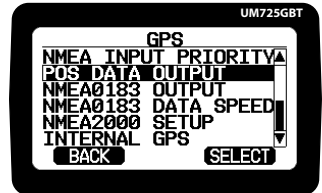

### NMEA2000 SETUP

1. Press **MENU** button, and then use the **PUSH/SEL** knob to access the **GPS** menu.
2. Use the **PUSH/SEL** knob to select **NMEA2000 SETUP**. The Select Device screen appears.
3. Press the **SEARCH** soft key. Your radio will search for connected devices, which will appear in the Select Device screen.
4. To connect to a device, select the device name and press **SELECT**.

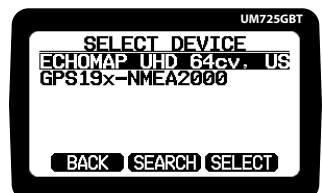
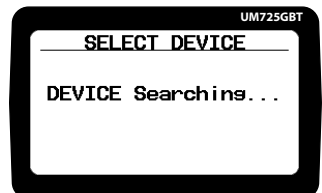
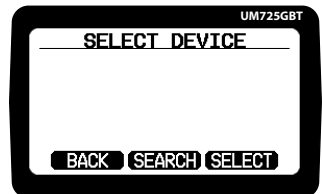
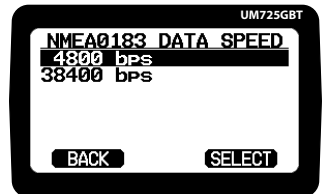

## MAINTENANCE AND TROUBLESHOOTING

Due to its rugged design, your radio requires very little maintenance. However, it is a precision electronic instrument, so you should follow a few precautions:

- If the antenna has been damaged, do not transmit except in an emergency situation. Doing so may cause further radio damage.
- You are responsible for continued FCC technical compliance of your radio.
- Arrange for periodic performance checks with your Uniden dealer.

Problem	Things to Try
The radio won't turn on.	If you turn the radio on immediately after turning it off, the power may not turn on due to data saving. Wait for few seconds and turn it on again. Check the fuse. Check polarity. Check the line voltage (10.5V to 16V).
The radio won't transmit.	Make sure you are not in Weather mode. Make sure you are not trying to transmit on a receive-only channel. See "Marine Radio Channel Chart" on page E-47. Make sure the duration of each transmission is less than 5 minutes.
Noise comes out of the speaker all the time	Adjust the squelch level; it is probably too low.
I can transmit, but no one can hear me.	Check your radio settings. See "Radio Setup" on page E-15. Does the area you are in use different channel assignments?
I'm not getting hazard alerts.	Make sure Weather Alert Watch is turned on.
The display flashes, and I don't know why.	The channel number on the display will flash if the radio is in a Watch mode or in Scan mode. Try turning off scanning, Weather Alert Watch, Triple Watch, or Dual Watch beginning on Page E-20.
Scan won't start.	Be sure you have channels saved into into Memory. See "Scanning Radio Channels" on page E-17.
No beeps sound.	Key beep is set to OFF. Turn Key Beep on.
I cannot send DSC calls.	Make sure the MMSI (DSC self ID) is entered.
Where can I find my radio's serial number?	The serial number is on a plate on the bottom of the radio or can be accessed in the ABOUT Menu.
When I turn on the radio, I get a message that "POSITION DATA NOT ACQUIRED"	Check GPS connection and settings.



## RESETTING YOUR RADIO

The Reset function restores all your radio's settings to factory settings.

1. Press the **MENU** button and use the **PUSH/SEL** knob to select **RESET**. The Rest screen appears.
2. Press the **YES** soft key to restore all setting to factory setting. The radio will restart.

---

Note: The MMSI number cannot be erased.

---

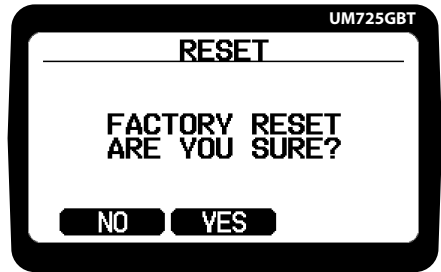

## SPECIFICATIONS

<b>General</b>	
Frequency Range	Transmitter 156.025-161.600MHz/Receiver 156.050-163.275MHz
Display	Full Dot Matrix LCD With Amber & White Cooler Back Light
Size (W/O Heatsink & Knobs)	H:3.38 X W:5.94 X 2.50 Inch ( H:85.7 X W:150.7 X L:63.5mm)
Weight	Approx. 35.3oz (1kg) With Mic
Power Supply Voltage	13.8V (10.5V - 16V) Negative Ground Only
Antenna Impedance	50 $\Omega$
Microphone	Electret Type
Speaker	4 $\Omega$ 4W (Radio) / 0.5W (Sp Mic)
Water Protect Class	IPx8
Operating Temp.range	5°F to 131°F (-15°C To +55°C)
Storage Temp.range	-22°F To 140°F (-30°C To +60°C)
<b>Transmitter</b>	
Frequency Tolerance @ 25°C	$\pm$ 2.5ppm Max.
Power Output	Hi 25W / Lo 1W
Spurious Emission	Hi Power -45dBm / Low Power -55dBm
Modulation Frequency Response	-6dB @500Hz, +6.5dB@2KHz (1KHz $\pm$ 1.0KHz Dev. Ref)
Microphone Sensitivity For $\pm$ 3khz Dev.	6mV
Hum & Noise Ratio (300hz, 3000hz Bpf 750us Deem.)	45dB
Modulation Distortion 750us Deemphasis	0.6% (0.3KHz To 3KHz B.P.H @ $\pm$ 3.0KHz Deviation)
Current Drain @ High Power	4.6A Nominal 6A Max @13.8V DC
<b>Receiver</b>	
Sensitivity for 20dB SINAD [Main] With CCITT	0.27uV
Squelch Sensitivity [Main]	Threshold 0.2uV / Tight 0.5uV
Audio Frequency Response 1KHz Reference	+6.5dB @500Hz, -6.5dB@2KHz
Adjacent Channel Selectivity	76dB @ $\pm$ 25KHz
Inter Modulation Immunity	70dB
1st & 2nd Image Rejection	80dB
1st & 2nd If Rejection	85dB
Hum & Noise Ratio	45dB
Audio Output Power @ 10% Distortion	2W Internal /2.2W External Speaker
Current Drain @No Signal	500mA MAX @No Signal/1.2A MAX at Maximum Audio Output

Battery Voltage Alert	Low 10V/High 17V
<b>GPS (UM725GBT/UM725G Only)</b>	
Acquisition Sensitivity CN	40dB (@GPS anechoic box input -103dBm)
Acquisition Time	30sec. (@GPS anechoic box input -103dBm) Limit 90sec.
GPS External Antenna Connector	3.3V / 20mA MAX
<b>Bluetooth (UM725GBT Only)</b>	
Sensitivity (Ber≤10-e5)	-90dBm(BT anechoic box input -60dBm, 1 Mbps BLE IDLE Tx)
Class / Version	BLE / V5.0

## REFERENCE TABLES

### MARINE RADIO CHANNEL CHART

The table below lists the channel display name and description used in the following tables and what each description means.

Channel Names	Description
DISTRESS SAFETY AND CALLING	primarily emergency messages and distress calls
INTERSHIP SAFETY	safety messages from one ship to another, or from a ship to Coast Guard aircraft
NON-COMMERCIAL (recreational or voluntary ships only)	messages about ship needs, including fishing reports, rendezvous, repair scheduling and berthing information
COMMERCIAL (working ships only)	messages about ship needs or ship business
PUBLIC CORRESPONDENCE/ MARINE OPERATOR	calls to the marine operator at a public coast station. Marine operators can connect to telephone networks. (There is usually a charge for this service.)
PORT OPERATIONS/ VTS (ship traffic system)	messages about the movement and safety of ships in or near ports, locks or waterways. In certain major ports, some channels may be restricted to specific types of port operations messages.
NAVIGATIONAL/ BRIDGE TO BRIDGE	messages about ship navigation, for example, passing or meeting other ships, maneuvering through locks, or navigating around drawbridges. Messages must be short!
STATE CONTROL	messages about government regulation and control, boating activities, or assistance to ships; also used to talk to ships and coastal stations operated by state or local governments
DIGITAL SELECTIVE CALLING	DSC signals only (no voice communications allowed at any time)

## USA Frequency Chart

Ch No.	TX Freq.	RX Freq.	Status	Channel Name
1001	156.0500	156.0500	Simplex	Vessel traffic system/Commercial
1003	156.1500	156.1500	Simplex	Coast guard only
1005	156.2500	156.2500	Simplex	Vessel traffic system/Commercial
6	156.3000	156.3000	Simplex	Inter-ship safety
1007	156.3500	156.3500	Simplex	Commercial
8	156.4000	156.4000	Simplex	Commercial(ship-ship)
9	156.4500	156.4500	Simplex	Non Commercial
10	156.5000	156.5000	Simplex	Commercial
11	156.5500	156.5500	Simplex	Vessel traffic system
12	156.6000	156.6000	Simplex	Vessel traffic system
13	156.6500	156.6500	Simplex, 1W	Bridge to bridge
14	156.7000	156.7000	Simplex	Vessel traffic system
15	Inhibit	156.7500	Receive Only	Environmental
16	156.8000	156.8000	Simplex	Distress, Safety, Calling
17	156.8500	156.8500	Simplex, 1W	Govt maritime control
1018	156.9000	156.9000	Simplex	Commercial
1019	156.9500	156.9500	Simplex	Commercial
20	157.0000	161.6000	Duplex	Port operations
1020	157.0000	157.0000	Simplex	Port operations
1021	157.0500	157.0500	Simplex	Coast guard only
1022	157.1000	157.1000	Simplex	Coast guard
1023	157.1500	157.1500	Simplex	Coast guard only
24	157.2000	161.8000	Duplex	Marine operator
25	157.2500	161.8500	Duplex	Marine operator
26	157.3000	161.9000	Duplex	Marine operator
27	157.3500	161.9500	Duplex	Marine operator
28	157.4000	162.0000	Duplex	Marine operator
1061	156.0750	156.0750	Simplex	Coast guard only
1063	156.1750	156.1750	Simplex	Vessel traffic system
1064	156.2250	156.2250	Simplex	Marine operator
1065	156.2750	156.2750	Simplex	Port operations
1066	156.3250	156.3250	Simplex	Port operations
67	156.3750	156.3750	Simplex, 1W	Bridge to bridge
68	156.4250	156.4250	Simplex	Non Commercial
69	156.4750	156.4750	Simplex	Non Commercial
70	156.5250	156.5250	DSC Only	DSC*
71	156.5750	156.5750	Simplex	Non Commercial
72	156.6250	156.6250	Simplex	Non Commercial* (ship-ship)
73	156.6750	156.6750	Simplex	Port operations
74	156.7250	156.7250	Simplex	Port operations
75	156.7750	156.7750	Simplex, 1W	Port operations(ship-ship)
76	156.8250	156.8250	Simplex, 1W	Port operations(ship-ship)

Ch No.	TX Freq.	RX Freq.	Status	Channel Name
77	156.8750	156.8750	Simplex, 1W	Port operations(ship-ship)
1078	156.9250	156.9250	Simplex	Non Commercial
1079	156.9750	156.9750	Simplex	Commercial
1080	157.0250	157.0250	Simplex	Commercial
1081	157.0750	157.0750	Simplex	Coast guard only
1082	157.1250	157.1250	Simplex	Coast guard only
1083	157.1750	157.1750	Simplex	Coast guard only
84	157.2250	161.8250	Duplex	Marine operator
85	157.2750	161.8750	Duplex	Marine operator
86	157.3250	161.9250	Duplex	Marine operator
87	157.3750	157.3750	Simplex	Port operations
88	157.4250	157.4250	Simplex	Port operations

### **Canadian Frequency Chart**

Ch No.	TX Freq.	RX Freq.	Status	Channel Name
1	156.0500	160.6500	Duplex	Marine operator
2	156.1000	160.7000	Duplex	Marine operator
3	156.1500	160.7500	Duplex	Marine operator
1004	156.2000	156.2000	Simplex	Canadian coast guard
1005	156.2500	156.2500	Simplex	Vessel traffic system
6	156.3000	156.3000	Simplex	Inter-ship safety
1007	156.3500	156.3500	Simplex	Commercial
8	156.4000	156.4000	Simplex	Commercial(ship-ship)
9	156.4500	156.4500	Simplex	Boater calling channel
10	156.5000	156.5000	Simplex	Commercial
11	156.5500	156.5500	Simplex	Vessel traffic system
12	156.6000	156.6000	Simplex	Vessel traffic system
13	156.6500	156.6500	Simplex, 1W	Bridge to bridge
14	156.7000	156.7000	Simplex	Vessel traffic system
15	156.7500	156.7500	Simplex, 1W	Commercial
16	156.8000	156.8000	Simplex	Distress, Safety, Calling
17	156.8500	156.8500	Simplex, 1W	State Control
1018	156.9000	156.9000	Simplex	Commercial
1019	156.9500	156.9500	Simplex	Canadian coast guard
20	157.0000	161.6000	Duplex, 1W	Canadian coast guard
1021	157.0500	157.0500	Simplex	Canadian coast guard
2021	Inhibit	161.6500	Simplex	CMB Service
1022	157.1000	157.1000	Simplex	Canadian coast guard
23	157.1500	161.7500	Duplex	Marine operator
2023	Inhibit	161.7500	Simplex	CMB Service
24	157.2000	161.8000	Duplex	Marine operator
25	157.2500	161.8500	Duplex	Marine operator

Ch No.	TX Freq.	RX Freq.	Status	Channel Name
2025	Inhibit	161.8500	Simplex	CMB Service
26	157.3000	161.9000	Duplex	Marine operator
27	157.3500	161.9500	Duplex	Marine operator
28	157.4000	162.0000	Duplex	Marine operator
2028	Inhibit	162.0000	Simplex	CMB Service
60	156.0250	160.6250	Duplex	Marine operator
1061	156.0750	156.0750	Simplex	Canadian coast guard
1062	156.1250	156.1250	Simplex	Canadian coast guard
1063	156.1750	156.1750	Simplex	Vessel traffic system
64	156.2250	160.8250	Duplex	Marine operator
1064	156.2250	156.2250	Simplex	Marine operator
1065	156.2750	156.2750	Simplex	Port operations
1066	156.3250	156.3250	Simplex, 1W	Port operations
67	156.3750	156.3750	Simplex	Commercial
68	156.4250	156.4250	Simplex	Non Commercial
69	156.4750	156.4750	Simplex	Commercial
70	156.5250	156.5250	DSC Only	DSC*
71	156.5750	156.5750	Simplex	Non Commercial
72	156.6250	156.6250	Simplex	Non Commercial*
73	156.6750	156.6750	Simplex	Commercial
74	156.7250	156.7250	Simplex	Commercial
75	156.7750	156.7750	Simplex, 1W	Port operations(ship-ship)
76	156.8250	156.8250	Simplex, 1W	Port operations(ship-ship)
77	156.8750	156.8750	Simplex, 1W	Port operations(ship-ship)
1078	156.9250	156.9250	Simplex	Non Commercial
1079	156.9750	156.9750	Simplex	Commercial
1080	157.0250	157.0250	Simplex	Commercial
1081	157.0750	157.0750	Simplex	Canadian coast guard
1082	157.1250	157.1250	Simplex	Canadian coast guard
1083	157.1750	157.1750	Simplex	Canadian coast guard
2083	Inhibit	161.7750	Simplex	CMB Service
84	157.2250	161.8250	Duplex	Marine operator
85	157.2750	161.8750	Duplex	Marine operator
86	157.3250	161.9250	Duplex	Marine operator
87	157.3750	157.3750	Simplex	Port operations
88	157.4250	157.4250	Simplex	Port operations

### **International Frequency Chart**

Ch No.	TX Freq.	RX Freq.	Status	Channel Name
1	156.0500	160.6500	Duplex	Marine operator
2	156.1000	160.7000	Duplex	Marine operator
3	156.1500	160.7500	Duplex	Marine operator

Ch No.	TX Freq.	RX Freq.	Status	Channel Name
4	156.2000	160.8000	Duplex	Marine operator
5	156.2500	160.8500	Duplex	Marine operator
6	156.3000	156.3000	Simplex	Inter-ship safety
7	156.3500	160.9500	Duplex	Marine operator
8	156.4000	156.4000	Simplex	Commercial(ship-ship)
9	156.4500	156.4500	Simplex	Boater calling channel
10	156.5000	156.5000	Simplex	Commercial
11	156.5500	156.5500	Simplex	Vessel traffic system
12	156.6000	156.6000	Simplex	Vessel traffic system
13	156.6500	156.6500	Simplex	Bridge to bridge
14	156.7000	156.7000	Simplex	Vessel traffic system
15	156.7500	156.7500	Simplex, 1W	Commercial
16	156.8000	156.8000	Simplex	Distress, Safety, Calling
17	156.8500	156.8500	Simplex, 1W	Govt maritime control
18	156.9000	161.5000	Duplex	Port operations
19	156.9500	161.5500	Duplex	Port operations
1019	156.9500	156.9500	Simplex	Commercial
2019	161.5500	161.5500	Simplex	Port operations
20	157.0000	161.6000	Duplex	Port operations
1020	157.0000	157.0000	Simplex	Port operations
2020	161.6000	161.6000	Simplex	Port operations
21	157.0500	161.6500	Duplex	Port operations
22	157.1000	161.7000	Duplex	Port operations
23	157.1500	161.7500	Duplex	Marine operator
24	157.2000	161.8000	Duplex	Marine operator
25	157.2500	161.8500	Duplex	Marine operator
26	157.3000	161.9000	Duplex	Marine operator
27	157.3500	161.9500	Duplex	Marine operator
28	157.4000	162.0000	Duplex	Marine operator
60	156.0250	160.6250	Duplex	Marine operator
61	156.0750	160.6750	Duplex	Marine operator
62	156.1250	160.7250	Duplex	Marine operator
63	156.1750	160.7750	Duplex	Marine operator
64	156.2250	160.8250	Duplex	Marine operator
65	156.2750	160.8750	Duplex	Marine operator
66	156.3250	160.9250	Duplex	Marine operator
67	156.3750	156.3750	Simplex	Bridge to bridge
68	156.4250	156.4250	Simplex	Non commercial
69	156.4750	156.4750	Simplex	Port operations(ship-ship)
70	156.5250	156.5250	DSC Only	DSC*
71	156.5750	156.5750	Simplex	Port operations
72	156.6250	156.6250	Simplex	Non commercial
73	156.6750	156.6750	Simplex	Port operations(ship-ship)

Ch No.	TX Freq.	RX Freq.	Status	Channel Name
74	156.7250	156.7250	Simplex	Port operations(ship-ship)
75	156.7750	156.7750	Simplex, 1W	Port operations(ship-ship)
76	156.8250	156.8250	Simplex, 1W	Port operations(ship-ship)
77	156.8750	156.8750	Simplex	Port operations(ship-ship)
78	156.9250	161.5250	Duplex	Marine operator
1078	156.9250	156.9250	Simplex	Port operations
2078	161.5250	161.5250	Simplex	Port operations
79	156.9750	161.5750	Duplex	Port operations
1079	156.9750	156.9750	Simplex	Port operations
2079	161.5750	161.5750	Simplex	Port operations
80	157.0250	161.6250	Duplex	Port operations
81	157.0750	161.6750	Duplex	Port operations
82	157.1250	161.7250	Duplex	Marine operator
83	157.1750	161.7750	Duplex	Marine operator
84	157.2250	161.8250	Duplex	Marine operator
85	157.2750	161.8750	Duplex	Marine operator
86	157.3250	161.9250	Duplex	Marine operator
87	157.3750	157.3750	Simplex	Port operations
88	157.4250	157.4250	Simplex	Port operations

\* Since CH70 is a DSC dedicated channel, the channel is not displayed and cannot be selected.

### ***Weather Channels and Frequencies (Us, Can, And Intl)***

Ch No.	RX Freq	Ch No.	RX Freq
WX01	162.550	WX06	162.500
WX02	162.400	WX07	162.525
WX03	162.475	WX08	161.650
WX04	162.425	WX09	161.775
WX05	162.450	WX10	163.275

### **EMERGENCY ALERT (SAME) SYSTEM EVENT TYPES**

- A WARNING is an event that alone poses a significant threat to public safety and/or property, probability of occurrence and location is high, and onset time is relatively short.
- A WATCH meets the classification of a warning, but either the onset time, probability of occurrence, or location is uncertain.
- An EMERGENCY is an event that, by itself, would not kill or injure or do property damage, but indirectly may cause other things to happen that result in a hazard. For example, a major power or telephone loss in a large city alone is not a direct hazard, but disruption to other critical services could create a variety of conditions that could directly threaten public safety.
- A STATEMENT is a message containing follow up information to a warning, watch, or emergency.



<b>Event</b>	<b>SAME Code</b>
Administrative Message	ADR
Avalanche Watch	AVA
Avalanche Warning	AVW
Biological Hazard Warning	BHW
Boil Water Warning	BWW
Blizzard Warning	BZW
Child Abduction Emergency	CAE
Civil Danger Warning	CDW
Civil Emergency Message	CEM
Coastal Flood Watch	CFA
Coastal Flood Warning	CFW
Chemical Hazard Warning	CHW
Contaminated Water Warning	CWW
Dam Break Watch	DBA
Dam Break Warning	DBW
Contagious Disease Warning	DEW
Practice/Demo Warning	DMO (*1)
Dust Storm Warning	DSW
Emergency Action Notification	EAN
Emergency Action Termination	EAT
Earthquake Warning	EQW
Evacuation Immediate	EVI
Evacuation Watch	EVA
Extreme Wind Warning	EWW
Food Contamination Warning	FCW
Flash Flood Watch	FFA
Flash Flood Statement	FFS
Flash Flood Warning	FFW
Flood Watch	FLA
Flood Statement	FLS
Flood Warning	FLW
Fire Warning	FRW
Flash Freeze Warning	FSW
Freeze Warning	FZW
Hurricane Statement	HLS
Hazardous Materials Warning	HMW
Hurricane Watch	HUA
Hurricane Warning	HUW
High Wind Watch	HWA
High Wind Warning	HWW
Iceberg Warning	IBW

<b>Event</b>	<b>SAME Code</b>
Industrial Fire Warning	IFW
Local Area Emergency	LAE
Law Enforcement Warning	LEW
Land Slide Warning	LSW
National Audible Test	NAT
National Information Center	NIC
Network Message Notification	NMN
National Periodic Test	NPT
National Silent Test	NST
Nuclear Power Plant Warning	NUW
Power Outage Advisory	POS
Radiological Hazard Warning	RHW
Required Monthly Test	RMT
Required Weekly Test	RWT
Special Marine Warning	SMW
Special Weather Statement	SPS
Shelter in Place Warning	SPW
Storm Surge Watch	SSA
Storm Surge Warning	SSW
Severe Thunderstorm Watch	SVA
Severe Thunderstorm Warning	SVR
Severe Weather Statement	SVS
Tornado Watch	TOA
911 Telephone Outage Emergency	TOE
Tornado Warning	TOR
Tropical Storm Watch	TRA
Tropical Storm Warning	TRW
Tsunami Watch	TSA
Tsunami Warning	TSW
Volcano Warning	VOW
Wild Fire Watch	WFA
Wild Fire Warning	WFW
Winter Storm Watch	WSA
Winter Storm Warning	WSW
Unrecognized Warning	**W
Unrecognized Watch	**A
Unrecognized Emergency	**E
Unrecognized Statement	**S

\*1) The SAME Alert tone will not sound when the radio detects "DMO."

## NMEA2000 PGN LIST (UM725GBT / UM725G ONLY)

<b>Receive PGN:</b>
59392 ISO Acknowledgment
59904 ISO Request
60160 ISO Transport Protocol, Data Transfer
60416 ISO Transport Protocol, Connection Management
60928 ISO Address Claim
65240 ISO Commanded Address
126208 NMEA 2000 Request/Command/Acknowledgment, Group Function
126996 NMEA 2000 Product Information
127237 Heading/Track Control
127250 Vessel Heading
127258 Magnetic Variation
128259 Speed
129025 Position, Rapid Update
129026 COG and SOG, Rapid Update
129029 GNSS Position Data
129033 Local Time Offset
129539 GNSS DOPs
129540 GNSS Satellites in View

<b>Transmit PGN:</b>
59392 ISO Acknowledgment
59904 ISO Request
60928 ISO Address Claim
126208 NMEA 2000 Request/Command/Acknowledgment, Group Function
126464 NMEA 2000 Transmit/Receive PGN List, Group Function
126993 Heartbeat PGN
126996 NMEA 2000 Product Information
126998 NMEA 2000 Configuration Information
129025 Position, Rapid Update
129026 COG and SOG, Rapid Update
129029 GNSS Position Data
129539 GNSS DOPs
129540 GNSS Satellites in View
129799 Radio Frequency/Mode/Power
129808 DSC Call Information

# REGULATIONS AND SAFETY WARNINGS

**WARNING!** Read this information before using the radio.

## MARITIME RADIO SERVICES OPERATION

**Warning!** This transmitter will operate on channels/frequencies that have restricted use in the United States. The channel assignments include frequencies assigned for exclusive use of the U.S. Coast Guard, use in Canada, and use in international waters. Operation on these frequencies without proper authorization is strictly forbidden. See page E-47 for tables of the available channels and their uses. If you are still not certain which channels to use, see the FCC maritime radio page at the FCC website (<http://wireless.fcc.gov/marine/>) or contact the FCC Call Center at 1-888-CALL-FCC. For individuals requiring a license, such as commercial users, you should obtain a license application from your nearest FCC field office (for US users) or Industry Canada (for Canadian users).

## BASIC RADIO GUIDELINES

You should familiarize yourself with the rules on marine radios and be aware of which rules apply to your *ship*. Complete guidelines for all ship and marine radio types can be found at the US Coast Guard website under the topic Radio Info for Boaters (the direct link is <http://www.navcen.uscg.gov/?pageName=mtBoater>). Here are a few guidelines that affect nearly all boaters.

- If you have a VHF radio on your *ship*, you must maintain a watch on channel 16 (156.800 MHz) whenever the radio is not being used to communicate. Starting in 2004, if a radio is carried, it must be on and set to channel 16 whenever your *ship* is underway.
- If you hear a distress call, wait a few minutes to let a shore station or Coast Guard *ship* respond. If no other station has responded after 5 minutes, you must respond to the distress call.
- Do not make false mayday or distress calls as a prank or to test your radio. (This is essentially like making a false 9-1-1 call; you may be subject to fines.)

### FCC/Industry Canada Information

Output Power: Hi 25W / Lo 1W

Transmitter Frequency Range: 156.025-161.600MHz

This device complies with Part 15 of the FCC Rules. Operation is subject to the condition that this device does not cause harmful interference.

Unauthorized changes or modifications to this equipment may void compliance with the FCC Rules. Any change or modification must be approved in writing by Uniden. Changes or modifications not approved by Uniden could void the user's authority to operate the equipment.

### FCC RF Exposure Information

In August 1996 the Federal Communications Commission (FCC) of the United States with its action in Report and Order FCC 96-326 adopted an updated safety standard for human exposure to radio frequency electromagnetic energy emitted by FCC regulated transmitters. Those guidelines are consistent with the safety standard previously set by both U.S. and international standards bodies. The design of the radio complies with the FCC guidelines and these international standards.

Never allow children to operate the radio without adult supervision and the knowledge of the following guidelines.

**WARNING!** It is up to the user to properly operate this radio transmitter to insure safe operation. Please adhere to the following:

Use only the supplied or an approved antenna. Unauthorized antennas, modifications, or attachments could impair call quality, damage the radio, or violate FCC regulations.

Do not use the radio with a damaged antenna. If a damaged antenna comes into contact with the skin, a minor burn may result. Please contact your local dealer for a replacement antenna.

To maintain compliance with FCC RF exposure requirements, the radio must be used with a maximum duty cycle not exceeding 50% in a typical push-to-talk radio use time. DO NOT transmit for more than 50% of total radio use time.

## COMPLIANCE

### FCC Part 15

The equipment has been tested and found to comply with the limits for a Class B device, pursuant to Part 15 of the FCC rules. These limits are designed to provide reasonable protection against harmful interference in a residential installation. This equipment generates, uses, and can radiate radio frequency energy and, if not installed and used in accordance with the instructions, may cause harmful interference to radio communications. However, there is no guarantee that interference will not occur in a particular installation. If this equipment does cause harmful interference to radio or television reception, which can be determined by turning the equipment off and on, the user is encouraged to try to correct the interference by one of the following measures:

- Reorient or relocate the receiving antenna.
- Increase the separation between the equipment and the receiver
- Connect the equipment into an outlet on a circuit different from that to which the receiver is connected.
- Consult the dealer or an experienced radio/TV technician for help.

Changes or modifications not expressly approved by the party responsible for compliance could void your authority to operate the equipment. Any change or modification must be approved in writing by Uniden.

This device complies with Part 15 of the FCC rules. Operation is subject to the following two conditions: (1) This device may not cause harmful interference, and (2) this device must accept any interference received, including interference that may cause undesired operation.

Tout changement ou modification non approuvé expressément par la partie responsable pourrait annuler le droit à l'utilisateur de faire fonctionner cet équipement. Tout changement ou modification doit être approuvé par écrit par Uniden.

Avis de conformité à la FCC : Ce dispositif a été testé et s'avère conforme à l'article 15 des règlements de la Commission fédérale des communications (FCC). Ce dispositif est soumis aux conditions suivantes: 1) Ce dispositif ne doit pas causer d'interférences nuisibles et; 2) Il doit pouvoir supporter les parasites qu'il reçoit, incluant les parasites pouvant nuire à son fonctionnement.

This equipment complies with FCC radiation exposure limits set forth for an uncontrolled environment. This equipment should be installed and operated with a minimum distance of 130cm between the radiator & your body. This transmitter must not be co-located or operating in conjunction with any other antenna or transmitter.

## IC

This device contains licence-exempt transmitter(s)/receiver(s) that comply with Innovation, Science and Economic Development Canada's licence-exempt RSS(s). Operation is subject to the following two conditions:

- (1) This device may not cause interference.
- (2) This device must accept any interference, including interference that may cause undesired operation of the device.

L'émetteur/récepteur exempt de licence contenu dans le présent appareil est conforme aux CNR d'Innovation, Sciences et Développement économique Canada applicables aux appareils radio exempts de licence. L'exploitation est autorisée aux deux conditions suivantes:

- (1) L'appareil ne doit pas produire de brouillage;
- (1) L'appareil doit accepter tout brouillage radioélectrique subi, même si le brouillage est susceptible d'en compromettre le fonctionnement.

The device meets the exemption from the routine evaluation limits in section 2.5 of RSS 102 and compliance with RSS-102 RF exposure, users can obtain Canadian information on RF exposure and compliance.

Le dispositif rencontre l'exemption des limites courantes d'évaluation dans la section 2.5 de RSS 102 et la conformité à l'exposition de RSS-102 rf, utilisateurs peut obtenir l'information canadienne sur l'exposition et la conformité de rf.

This transmitter must not be co-located or operating in conjunction with any other antenna or transmitter. This equipment should be installed and operated with a minimum distance of 130 centimeters between the radiator and your body.

Cet émetteur ne doit pas être Co-placé ou ne fonctionnant en même temps qu'aucune autre antenne ou émetteur. Cet équipement devrait être installé et actionné avec une distance minimum de 130 centimètres entre le radiateur et votre corps.

## THREE-YEAR LIMITED WARRANTY

**WARRANTOR:** UNIDEN AMERICA CORP. (“Uniden”)

**ELEMENTS OF WARRANTY:** Uniden warrants, for three years, to the original retail owner, this Uniden Product to be free from defects in materials and craftsmanship with only the limitations or exclusions set out below.

**WARRANTY DURATION:** This warranty to the original user shall terminate and be of no further effect 36 months after the date of original retail sale. The warranty is invalid if the Product is (A) damaged or not maintained as reasonable or necessary, (B) modified, altered, or used as part of any conversion kits, subassemblies, or any configurations not sold by Uniden, (C) improperly installed, (D) serviced or repaired by someone other than an authorized Uniden service center for a defect or malfunction covered by this warranty, (E) used in any conjunction with equipment or parts or as part of any system not manufactured by Uniden, or (F) installed or programmed by anyone other than as detailed by the Operating Guide for this product.

**STATEMENT OF REMEDY:** In the event that the product does not conform to this warranty at any time while this warranty is in effect, warrantor will repair the defect and return it to you without charge for parts, service, or any other cost (except shipping and handling) incurred by warrantor or its representatives in connection with the performance of this warranty. THE LIMITED WARRANTY SET FORTH ABOVE IS THE SOLE AND ENTIRE WARRANTY PERTAINING TO THE PRODUCT AND IS IN LIEU OF AND EXCLUDES ALL OTHER WARRANTIES OF ANY NATURE WHATSOEVER, WHETHER EXPRESS, IMPLIED OR ARISING BY OPERATION OF LAW, INCLUDING, BUT NOT LIMITED TO ANY IMPLIED WARRANTIES OF MERCHANTABILITY OR FITNESS FOR A PARTICULAR PURPOSE. THIS WARRANTY DOES NOT COVER OR PROVIDE FOR THE REIMBURSEMENT OR PAYMENT OF INCIDENTAL OR CONSEQUENTIAL DAMAGES. Some states do not allow this exclusion or limitation of incidental or consequential damages so the above limitation or exclusion may not apply to you.

**LEGAL REMEDIES:** This warranty gives you specific legal rights, and you may also have other rights which vary from state to state. This warranty is void outside the United States of America.

**PROCEDURE FOR OBTAINING PERFORMANCE OF WARRANTY:** If, after following the instructions in this Operating Guide you are certain that the Product is defective, pack the Product carefully (preferably in its original packaging). Include evidence of original purchase and a note describing the defect that has caused you to return it. The Product should be shipped freight prepaid, by traceable means, or delivered, to warrantor at:

Uniden America Corporation  
C/O Saddle Creek  
743 Henrietta Creek Rd., Suite 100  
Roanoke, TX, 76262



**QUESTIONS?**  
Visit our website at  
[www.uniden.com](http://www.uniden.com).

**QUESTIONS?**  
Contactez-nous au  
[www.uniden.com](http://www.uniden.com).

U01UT662ZZZ(0)

Printed in Vietnam