

Power Connection Options (Direct to Battery)

Your Cobra CB radio is designed to be powered **only** by a 12V DC source and connecting directly to your vehicle's battery will provide you the best performance. Before making any power connections or turning the radio on, verify that the source you are connecting to is indeed a 12V DC power source.

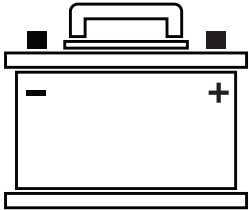

1. Connect the red wire (+) to the positive terminal of the battery and the black (-) wire to the negative terminal of the battery.
2. Connect the power cable into the back of the CB unit marked "Power". Be sure to observe the polarity.

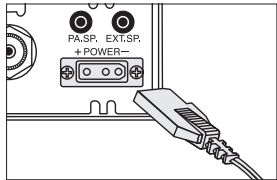

NOTE: Connecting to a switched accessory fuse prevents the unit from being left on accidentally, and permits operating the unit without running the engine.

NOTE: For older or vintage vehicles, visually check the vehicle's battery connection before installing the CB radio to determine which terminal is positive (+) or negative (-).

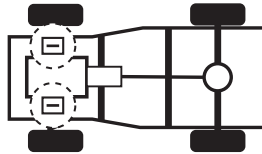
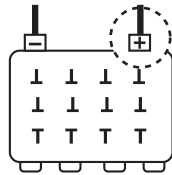

Power Connection Options (Fuse Tapper)

If you are unable to directly connect your CB radio to your vehicle's 12V battery, an alternative method is to use power from your fuse box via a fuse tapper to easily power your radio without any complicated wiring.

NOTE: While you can still power your CB radio by connecting to the fuse tapper, for best performance it is recommended to connect directly to your vehicle's battery.

Cobra[®]

CB Radio & Antenna

General Installation Overview

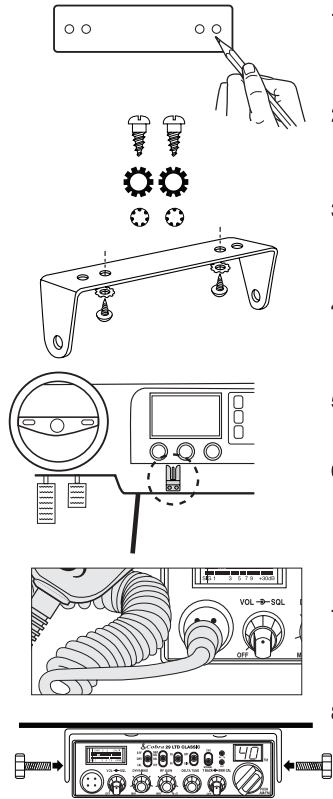

Mounting Your CB

1. Choose the most appropriate placement depending on the location and vehicle you are installing your CB.
2. Your CB radio wires and microphone should not in any way interfere with the driver's operation of the vehicle.
3. Mark the desired location for installation using the mounting bracket as a template for screw placement.
4. Drill holes for the mounting screws while taking care not to damage the vehicle's electrical system.
5. Secure the bracket using the provided mounting screws
6. Using the provided bracket and screws, place the microphone support in a location easily accessible by the driver without interfering with the controls of the vehicle.
7. Plug the microphone into the connector or pin receptacle located in the front of the unit.
8. Once all power and antenna connections have been made to the CB radio (see following pages), securely mount your CB radio to the mounting bracket.

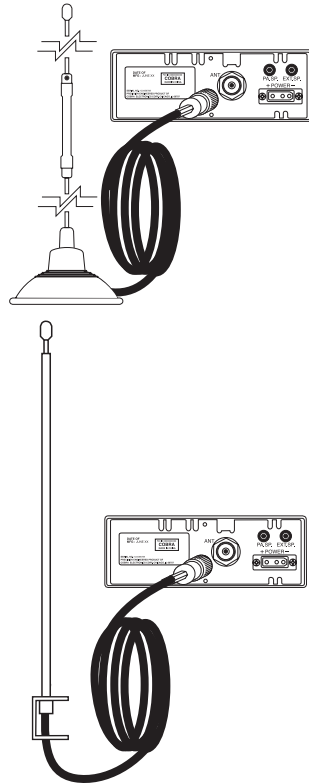

Antenna Installation Overview

A CB radio is only as good as the antenna it is connected to. You can choose from two types of mobile CB antennas, either a full-length whip antenna or a loaded whip antenna. There are several different mounting options. Choose the one that best fits your vehicle based on its requirements.

There are two main methods for installing your CB antenna. Temporary installation or permanent installation.

1. **Temporary installations** typically utilize an antenna with a magnetic base for easy installation anywhere on the roof or hood of your vehicle. The Cobra HG A1500 42-inch magnetic mount antenna is a good example of such an antenna.
2. For **permanent installations**, the CB antenna is used in conjunction with a more purpose-built metal base that attaches to a specific part of a vehicle, whether that be to the mirror, hood, trunk, etc.

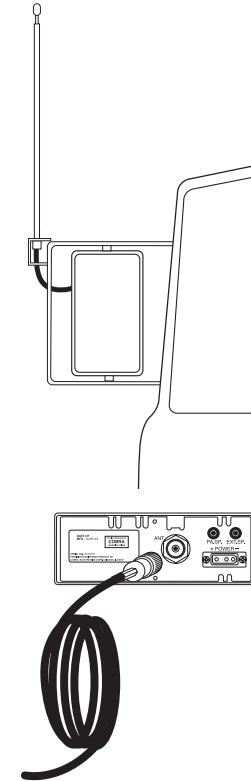

Antenna Installation (Permanent)

As previously stated, **permanent antenna installations** typically use a metal mounting piece in conjunction with the CB antenna to securely mount to a specific location on your vehicle. Each vehicle and CB user will have different mounting requirements, so make sure to determine the location that best suits your needs before mounting your antenna.

1. When installing a mobile antenna, it must be fixed to the vehicle where there is a maximum of metallic surface (ground plane). A poor ground plane will result in reduced transmission effectiveness from your CB radio.
2. For an antenna that is attached by drilling into the vehicle metallic body, ensure a good electrical ground between the coax shield and the vehicle body. Use proper protection for this electrical connection to guard against exposure to moisture.
3. When mounting of the antenna is complete, connect your coaxial cable running from your antenna to the antenna jack on the back of your CB radio. Be careful not to pinch the cable as this can also reduce your radio's transmission effectiveness.
3. Once your antenna is installed and connected to your CB radio you can adjust its SWR if it is an adjustable antenna. Consult your owner's manual for specific SWR adjustment instructions.