

## User Manual

Model No.: L-F502

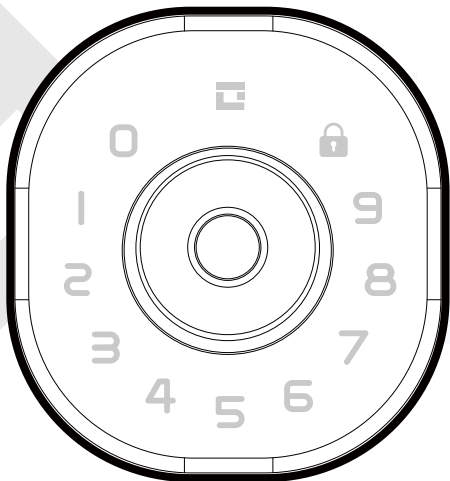

**IMPORTANT:** Read the instructions carefully before operating the device and keep them for future reference.

|                               |           |
|-------------------------------|-----------|
| <b>Features</b>               | <b>2</b>  |
| <b>Operating Instructions</b> | <b>3</b>  |
| <b>Troubleshooting</b>        | <b>21</b> |
| <b>Specifications</b>         | <b>23</b> |

## Welcome

GeekSmart bids you welcome to a world of smart home devices, smart locks, and smart surveillance. We at GeekSmart strive to explore and develop the smart home industry for the good of all.

We use cutting-edge technologies to develop products fit and ready for the market.

Please visit our website [www.geektechnology.com](http://www.geektechnology.com)

Before installing, please scan the QR codes to watch our easy step-by-step installation video.

If you have questions regarding the installation process please contact us by mail [customercare@geektechnology.com](mailto:customercare@geektechnology.com) or by phone **1-844-801-8880/(862)352-0406**.







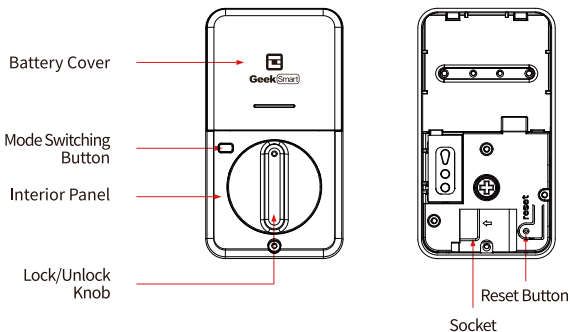
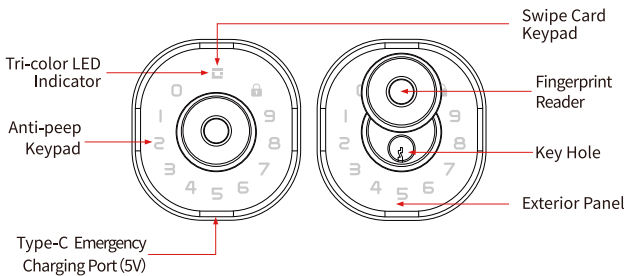





Scan the QR code for more assistance and support

# Product Description



## Included In The Box

|  |  |   |   |  |
|--|--|---|---|--|
| <p>A</p>  <p>Exterior panel<br/>1PC</p> | <p>B</p>  <p>Interior panel<br/>1PC</p> | <p>C</p>  <p>Interior mounting<br/>plate 1PC</p> | <p>D</p>  <p>Deadbolt<br/>1PC</p>  | <p>E</p>  <p>Strike plate<br/>1PC</p> |
| <p>F</p>  <p>Screws A<br/>4PCS</p>      | <p>G</p>  <p>Screws B<br/>3PCS</p>      | <p>H</p>  <p>Screws C<br/>3PCS</p>               | <p>I</p>  <p>IC Cards<br/>2PCS</p> | <p>J</p>  <p>Keys<br/>2PCS</p>        |

## Assembly Diagram

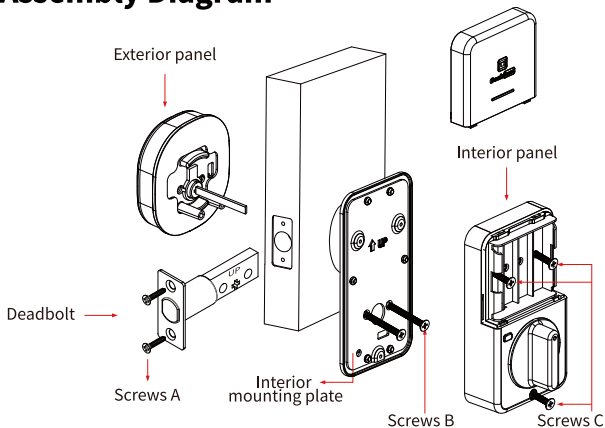

## Check The Door's Dimensions

Step 1: Measure to confirm that the door is between  $1\frac{1}{8}"$ ~ $2\frac{1}{8}"$  (35mm~54mm) thick.

Step 2: Measure to confirm that the hole in the door is  $2\frac{1}{8}"$  (54mm).

Step 3: Measure to confirm that the backset is either  $2\frac{3}{8}"$  or  $2\frac{3}{4}"$  (60-70mm).

Step 4: Measure to confirm that the hole in the door edge is  $1"$  (25mm).

NOTE: If you have a new door, please drill the holes according to Drill Template.

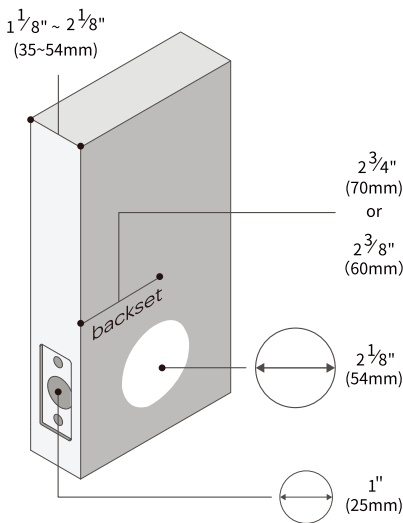

## Installing latch and strike plate

1. Install latch into the door, make sure latch fits inside the door opening.
2. Install the strike into the door frame, make sure the latch can go into the strike smoothly.

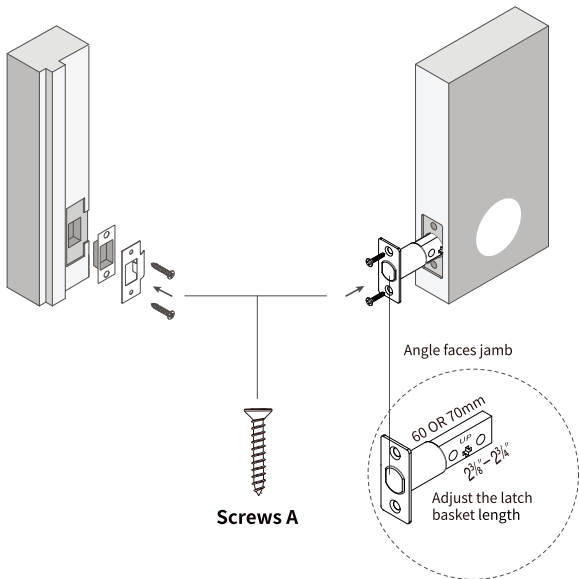

# Installation Exterior Panel

**NOTE:** The thumb latch should be in a vertical position.

**DO NOT CLOSE** the door until the door lock is fully installed and the batteries are installed.

**DO NOT CLOSE** the door until the administrator and the necessary code /card to open the door are set up.

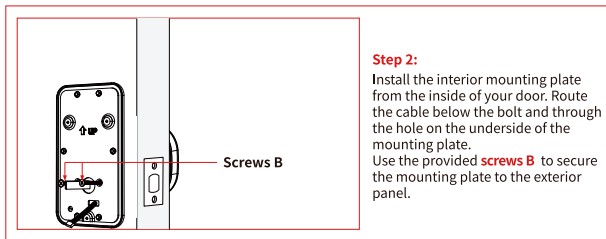
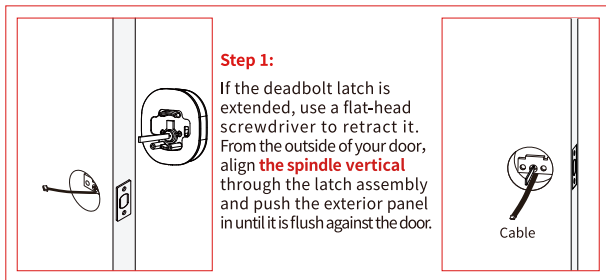

## Installing Interior Panel For Right Hinge

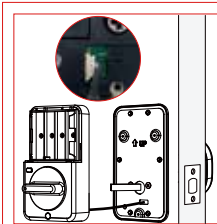
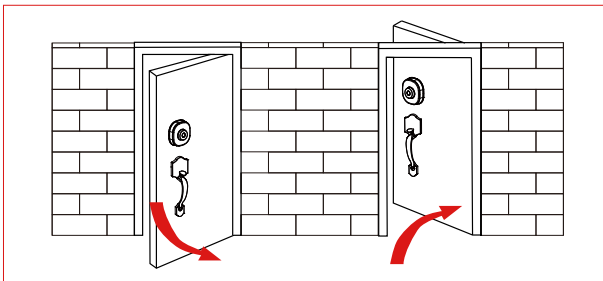

### Very important

#### Step 3:

For **right-hinged doors**, the knob should be **kept in a horizontal position**. Insert the connector of the cable to the socket on the interior panel. Press the connector in firmly until it is completely seated. Push the excess wire into the door, align the back panel until it is flush against the door.

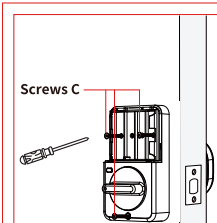

#### Step 4:

Attach interior panel to interior mounting plate and tighten 3 screws.

**Note:** Turn the knob of the interior panel to check if the deadbolt protrudes and retracts smoothly. Shut door to check if deadbolt protrudes and retracts in strike plate smoothly. If not, please review your installation or contact support.



## Installing Interior Panel For Left Hinge

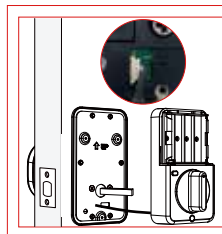
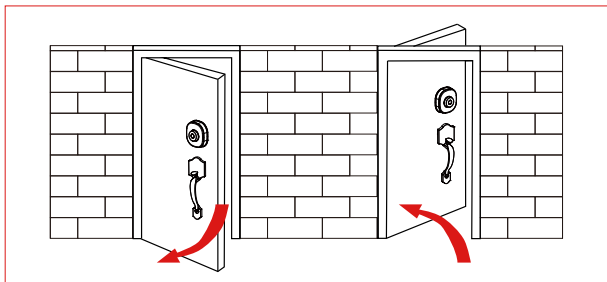

### Very important

#### Step 3:

For **left-hinged doors**, the knob should be kept in a **vertical position**. Insert the connector of the cable to the socket on the interior panel. Press the connector in firmly until it is completely seated. Push the excess wire into the door, align the back panel until it is flush against the door.

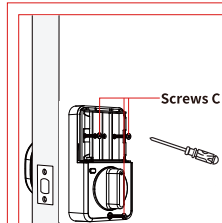

#### Step 4:

Attach the interior panel to the interior mounting plate and tighten 3 screws.

**Note:** Turn the knob of the interior panel to check if the deadbolt protrudes and retracts smoothly. Shut door to check if deadbolt protrudes and retracts in strike plate smoothly. If not, please review your installation or contact support.

## Installing Batteries

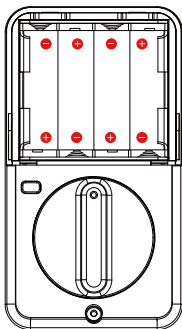

Insert 4\*AA batteries according to positive and negative polarity.

**Do not use rechargeable batteries.**

# App Operation Guide

## 1. App Download Instructions

- (1) Scan the QR code to the right, you can use Android and iOS to download the APP.
- (2) Android version software can be downloaded in the Google Play store. Search "GeekSmart".
- (3) iOS version of the software can be downloaded in the iPhone App Store. Search "GeekSmart".



## 1. Adding new door lock by app (Note: Keep your phone close by the door during this process).

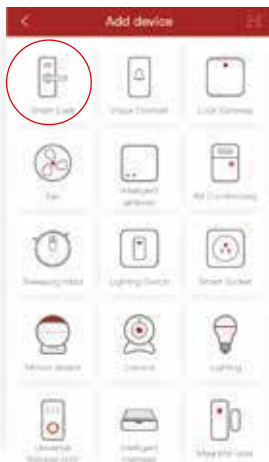

① Tap the add button “+”.

② Select the smart lock.

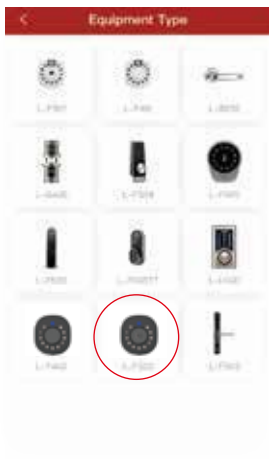

③ Select lock L-F502.



④ Turn on Bluetooth on your phone.



- ⑤ Activate the lock by pressing a key on the keypad.

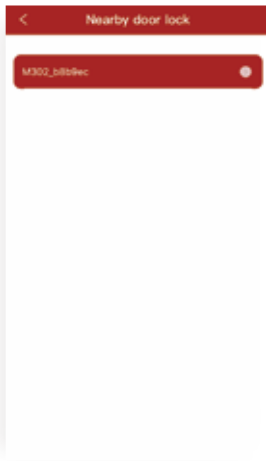

- ⑥ Select your lock.

## Please check the opening direction of your door

Right hinge

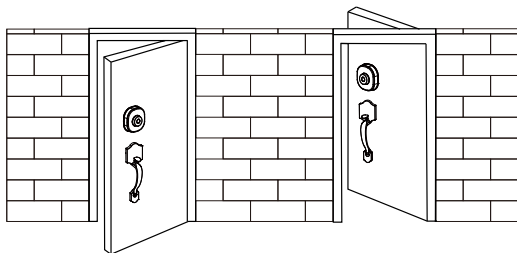

Left hinge

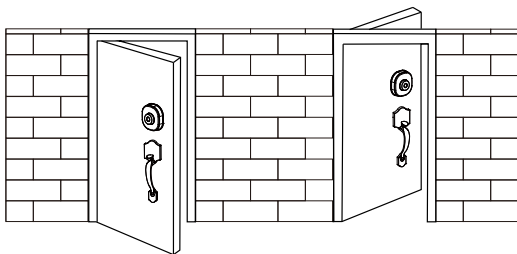

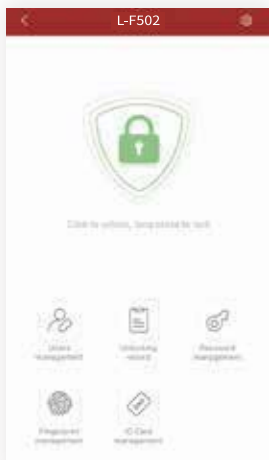

- ⑦ Door lock added successfully.

When door lock has been added successfully, please tap the "⚙️" button in the upper right corner to check your new administrator password.



- ⑧ Check administrator password.



## 2. Fingerprint management



- ① Note: please tap “+” symbol on the upper right corner to add a fingerprint.



- ② Enter fingerprint account name and details.

### 3. Access code management



- ① Please tap “+” in the right upper corner to add new user.



- ② Administrator can manage codes.

## 4. Users management



- ① Please tap “+” in the right upper corner to add new user.
- ② Administrator can manage all users.

Admins can send Ekeys to emails. The receiver needs to download the GeekSmart app and log in to use the Ekey.

Administrators can manage all users, delete Limited time user or Permanent user and view unlock records.

Access code management refers to the digital code combination of the door lock. You can send different types of codes to others to grant access.

**Once:** To be used one time only. This code can be copied and sent by email.

**Permanent:** to be used permanently, with no time limit.

**Limited time:** limited time access.

**Customized:** you can customize your permanent code.

The administrator can manage all the codes that were sent, deleting codes or sending new ones, modifying validity period, disable codes, and view unlock history.

## 5. Add bluetooth administrator

Make sure the door lock administrator is not added. With the door backlight off, the user touches the numeric keypad to wake up the door lock. After hearing the voice prompt "Please add Bluetooth administrator", open the mobile phone bluetooth and begin the door lock addition process on the app to obtain Bluetooth administrator privileges. After the addition is successful, you will hear the voice prompt "Administrator has been successfully added."

## 6. Delete bluetooth administrator through the app

The user must be running the app near the door lock. Tap the Setting button in the upper right corner of the added door lock on the homepage. After entering the door lock setting page, click the "restore factory settings" or "delete device" to remove Bluetooth administrator privileges.

## 7. IC Cards management (RFID-CARD management)

Add IC Card: please enter IC card name, tap "next", then please place the IC card against the card reader sensor on the smart lock.  
Clear IC card: tap "delete IC card" button.

## Settings By Keypad

Though we recommend using the app, you can chose to use the keypad to set up lock users etc.

### 1. Changing Admin Passcode (Default “123456”)

Ⓜ → 12 → Ⓜ → Original Passcode → Ⓜ → New Passcode → Ⓜ → New Passcode (again) → Ⓜ

If successful, lock should prompt “Input Successful”

### 2. Add User Passcode / Fingerprint / IC-Card

A. Add user passcode:

Ⓜ → 85 → Ⓜ → Admin Passcode → Ⓜ → New User Passcode → Ⓜ  
→ New User Passcode (again) → Ⓜ

B. Add User IC Card:

Ⓜ → 85 → Ⓜ → Admin Passcode → Ⓜ → SCAN CARD

C. Add User Fingerprint

Ⓜ → 85 → Ⓜ → Admin Passcode → Ⓜ → SCAN FINGERPRINT

### 3. Change User Passcode

Ⓜ → 10 → Ⓜ → Original Passcode → Ⓜ → New Passcode → Ⓜ → New Passcode (again) → Ⓜ

### 4. Delete All User IC-Cards

Ⓜ → 69 → Ⓜ → Admin Passcode → Ⓜ

### 5. Delete All User Fingerprints

Ⓜ → 70 → Ⓜ → Admin Passcode → Ⓜ

### 6. Delete All User Passcodes

Ⓜ → 71 → Ⓜ → Admin Passcode → Ⓜ

Note: except admin user, ALL user passcodes, including app users’ passcodes, will be deleted.

### 7. Set The Lock For “Right Hinge” Or “Left Hinge”

Ⓜ → 46 → Ⓜ → Admin Passcode → Ⓜ

A. 1 → Ⓜ → for right hinge.

B. 2 → Ⓜ → for left hinge.

# Troubleshooting

## **Q: How can I reset the lock?**

A: Please note all data will be erased if you reset F502 to factory default.

A: If you are using GeekSmart App as manager, please select “restore factory settings” or “Delete device”.

A: Remove then reinstall the batteries, press and hold the "Mode Switching Button" until you hear the voice "Enter the initialization password", then enter "000☎" on the keypad.

## **Q: How to active secure lock mode?**

A: Press and hold Mode Switching Button to activate or deactivate the secure lock mode.

A: When secure lock mode is activated, only the administrator ( it also requires administrator password) can unlock the lock.

## **Q: What is the difference between administrator, user?**

A: Administrator is the person who owns L-F502 and registers in GeekSmart App originally. Administrator has all lock management privileges.

A: User can always unlock via fingerprint, code or App.

## **Q: Does F502 work with third-party accessories such as a deadbolt?**

A: It is recommended to use the original accessories for best performance and stability.

## **Q: How can I control F502 remotely?**

A: L-F502 is a bluetooth enabled smart lock. You can pair the optional GeekSmart gateway with L-F502 to control it remotely via GeekSmart App.

## **Q: How can I adjust the lock orientation of L-F502?**

A: The lock orientation must be adjusted after installation to ensure L-F502 works properly.

A: Adjust the lock orientation directly on the lock. Go to page 7 or page 8 for details.

A: Adjust the lock orientation via the GeekSmart App.

**Q: What notification will I receive when the battery is low?**

A: In case of low battery power, there will be a voice reminder when unlocking, and the remaining battery power can be viewed in the APP door lock setting interface.

A: The remaining power can provide about 50 times to unlock. Please replace battery in time.

**Q: How can I unlock L-F502 if battery runs out?**

A: Use the key to unlock.

**Important Note:**

Please keep at least one key in secure location elsewhere as an extra precaution. Connect a 5V power bank to activate the lock temporarily.

**Q: How do I activate the lock after entering an incorrect code, card, fingerprint too many times?**

A: If the lock receives too many invalid unlock attempts, it will be temporarily disabled for security reasons. In this case, you can only unlock L-F502 with the GeekSmart App.

**Q: How to use passcode for unlock ?**

A: For example, your passcode is 123456, you should press any key to wake up the lock (light is on) → input123456 → press 

# Specifications

## TECHNICAL PARAMETERS

|    |                              |  |               |
|----|------------------------------|--|---------------|
| 1  | Power supply                 | 4.5~6.5V (4 pcs AA alkaline batteries) |               |
| 2  | Support phone system         | Android 4.3/IOS 7.0 or above           |               |
| 3  | Alarm voltage                | 4.8V $\pm$ 0.2V                        |               |
| 4  | Static current               | $\leq$ 75 $\mu$ A                      |               |
| 5  | Dynamic current              | $\leq$ 350mA                           |               |
| 6  | Operating temperature        | Exterior panel -25~70°C                |               |
|    |                              | Interior panel -10~50°C                |               |
| 7  | Operating humidity           | 20 ~ 93 %RH                            |               |
| 8  | FAR(False acceptance rate)   | < 0.001%                               |               |
| 9  | FRR( False reject rate)      | < 1.0%                                 |               |
| 10 | Fingerprint capacity         | 110pcs                                 |               |
| 11 | Opening delay                | around 1.5 seconds                     |               |
| 12 | Mobile phone app             | GeekSmart                              |               |
| 13 | RFID-Card (Mifare1) Capacity | 1000pcs                                |               |
| 14 | Access code capacity         | Code sent by the app                   | No limitation |
|    |                              | Custom code                            | 250 pcs       |



## FCC warning

Any Changes or modifications not expressly approved by the party responsible for compliance could void the user's authority to operate the equipment.

Note: This equipment has been tested and found to comply with the limits for a Class B digital device, pursuant to part 15 of the FCC Rules. These limits are designed to provide reasonable protection against harmful interference in a residential installation. This equipment generates uses and can radiate radio frequency energy and, if not installed and used in accordance with the instructions, may cause harmful interference to radio communications. However, there is no guarantee that interference will not occur in a particular installation. If this equipment does cause harmful interference to radio or television reception, which can be determined by turning the equipment off and on, the user is encouraged to try to correct the interference by one or more of the following measures:

- Reorient or relocate the receiving antenna.
- Increase the separation between the equipment and receiver.
- Connect the equipment into an outlet on a circuit different from that to which the receiver is connected.
- Consult the dealer or an experienced radio/TV technician for help.

This device complies with part 15 of the FCC Rules. Operation is subject to the following two conditions: (1) This device may not cause harmful interference, and (2) this device must accept any interference received, including interference that may cause undesired operation.



**GeekSmart**<sup>®</sup>

*Bring The Future Home*

Geektechnology Ltd.  
120 Route 46 West,  
Parsippany, NJ 07054.  
Toll Free  
1-844-801-8880  
(862)352-0406

