

GeekTale

User Manual

Model No.: K02

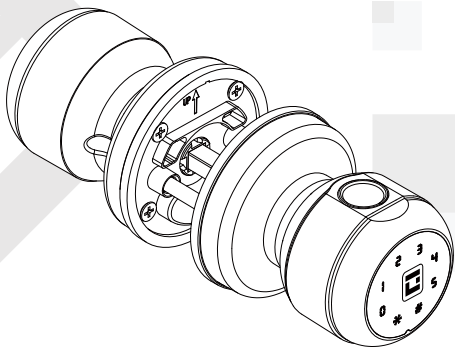

IMPORTANT: Read the instructions carefully before operating the appliance and keep them for future reference.



Welcome

Geek Tale bids you welcome to a world of smart home devices, smart locks, and smart surveillance. We at **Geek Tale** strive to explore and develop the smart home industry for the good of all.

We use cutting-edge technologies to develop products fit and ready for the market.

Please visit our website www.geektechnology.com.

Before installing, please scan the QR codes to watch our easy step-by-step installation video.

If you have questions regarding the installation process, please contact us by mail service_lock@geektechnology.com or by phone 1-844-801-8880.



Scan the QR code for more
Geek Tale Products

INCLUDED IN THE BOX

A



Exterior knob
1PC

B



Interior knob
1PC

C



Single latch
1PC

D



Strike parts
1PC

E



Screws A
4PCS

F



Screws B
2PCS

G



Keys
2PCS

H



Warranty card
1PC

ASSEMBLY DIAGRAM

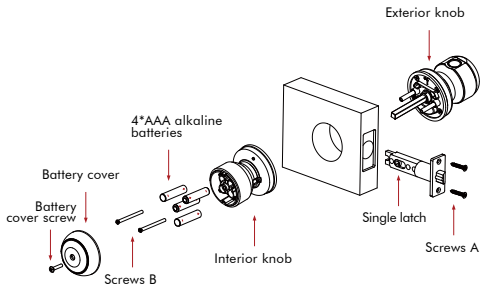

PRODUCT DESCRIPTION

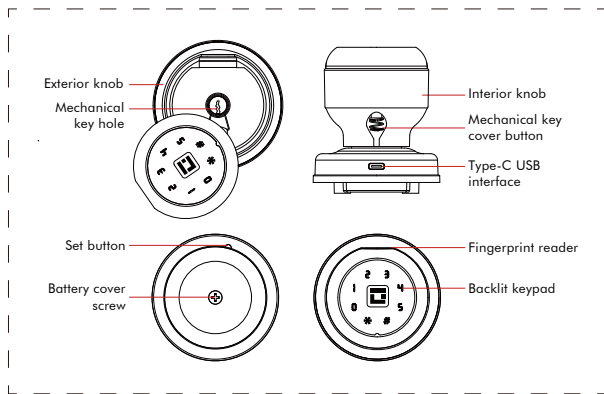

Indicator Light

1. Add fingerprint

Blue light: The fingerprint light turns to blue as to indicate the lock is ready to add fingerprint.

2. Fingerprint, mobile phone APP unlock

Green light: Success (the buzzer beeps once, and the fingerprint light flashes green).

Red light: Failed (the buzzer beeps twice, the fingerprint light flashes red).

3. Low power

Green+red light: When the lock is unlocked with fingerprint or mobile APP the buzzer beeps once and fingerprint light flash green and red.

PRODUCT DIMENSIONS

Exterior Knob

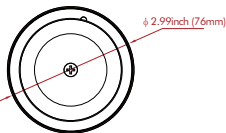
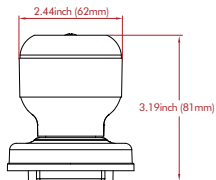

Interior Knob

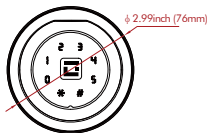
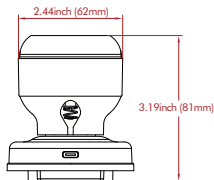

Single Latch

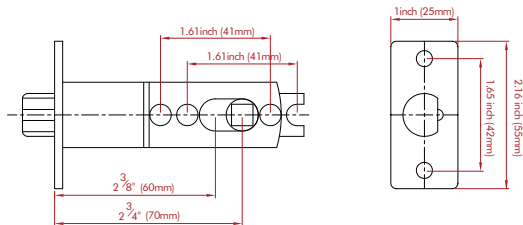



CHECK THE DOOR'S DIMENSIONS

Step 1: Measure to confirm that the door is between $1\frac{3}{8}" \sim 2\frac{1}{8}"$ (35mm ~54mm) thick.

Step 2: Measure to confirm that the hole in the door is $2\frac{1}{8}"$ (54mm).

Step 3: Measure to confirm that the backset is either $2\frac{3}{4}"$ - $2\frac{3}{8}"$ (60-70mm).

Step 4: Measure to confirm that the hole in the door edge is $1"$ (25mm).

Note: If you have a new door, please drill the holes according to Drill Template.

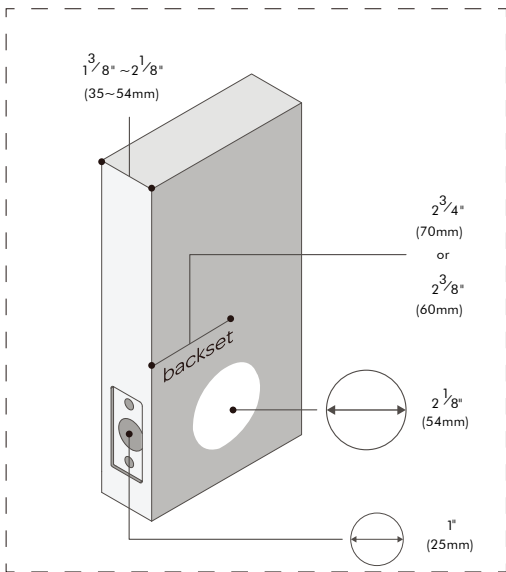

INSTALLING LATCH AND STRIKE PLATE

1. Install latch into the door, make sure latch fits inside the door opening.
2. Install the strike into the door frame, make sure the latch can go into the strike smoothly.

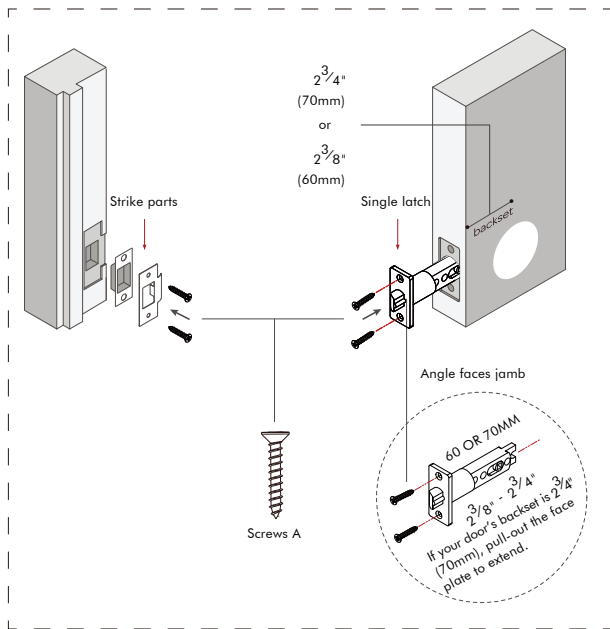

INSTALLING EXTERIOR KNOB

Install the spindle Exterior Knob, Insert the spindle and the standoffs into the corresponding holes of the single latch.

Note:

DO NOT CLOSE THE DOOR until the door lock is fully installed and the batteries are installed.

Note:

Make sure the knob is installed correctly with up ↑ sign positioned on the top of the knob.

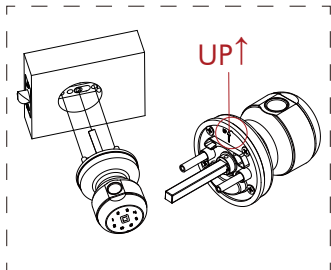

INSTALLING INTERIOR KNOB

Install the Interior Knob. Use a screwdriver to unscrew the battery cover screw. Connect the exterior knob and Interior knob wirings, Install the Interior Knob.

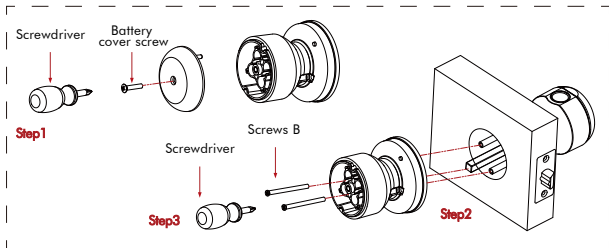

Note:

The UP ↑ faces upwards. After adjusting the Interior Knob, tighten the screw B.

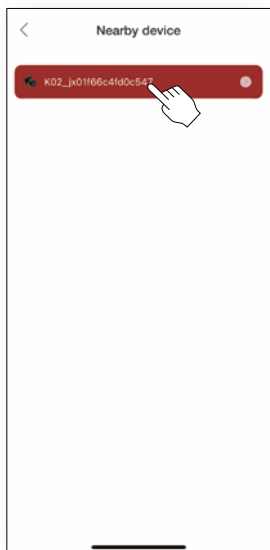

④ Select your lock.

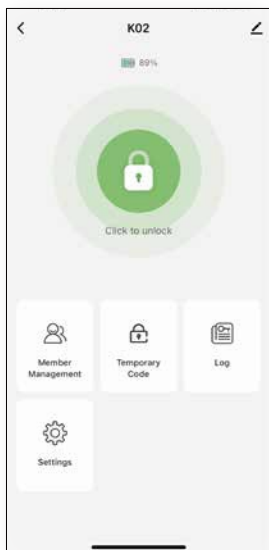

⑤ Add complete.

ADDING DEVICE

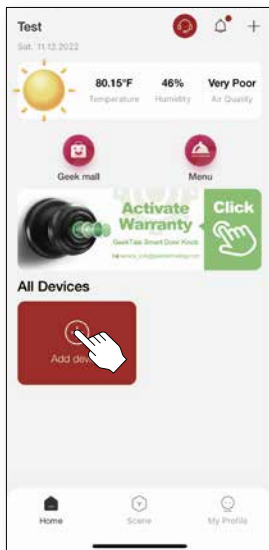

① Tap add device button.

② Select the K02.

③ Continue to follow the instruction on the App interface.

INSTALLING BATTERIES

Note:

Pay attention to the direction of the positive and negative electrodes when installing the battery.

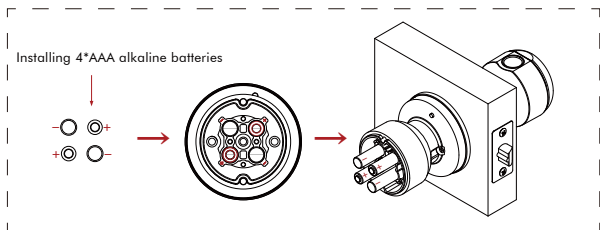

DO NOT USE RECHARGEABLE BATTERIES.

DOWNLOAD THE GEEKSMART APP

1. App Download Instructions

- Scan the QR code on the right you can use Android and iOS to download the APP.
- Android version software can be downloaded in the Google Play store. Search "GeekSmart".
- iOS version of the software can be downloaded in the iPhone App Store. Search "GeekSmart".

2. Register and log in with your E-mail address.



HOW TO ADD FINGERPRINT BY GEEKSMART APP

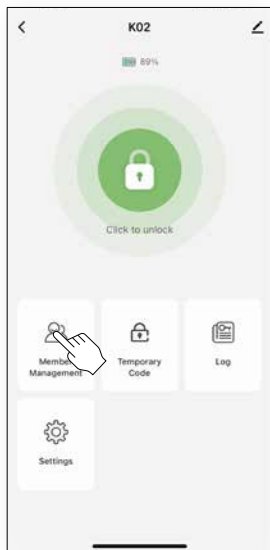

① Click member mangement.

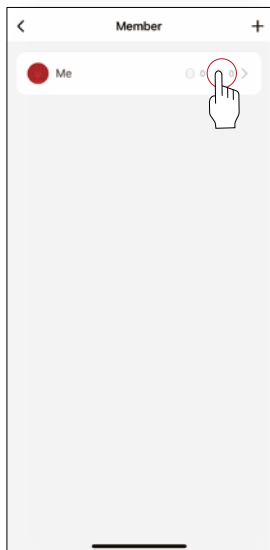

② Click me.

③ Continue to follow the instruction on the App interface.

HOW TO DELETE FINGERPRINT BY GEEKSMART APP

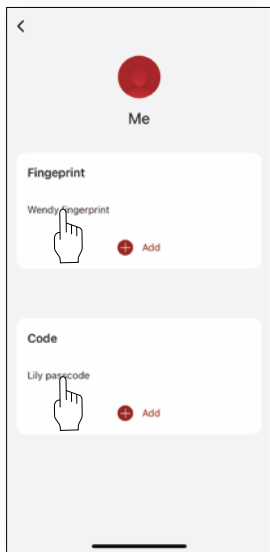

① Tap the fingerprint you want to delete.

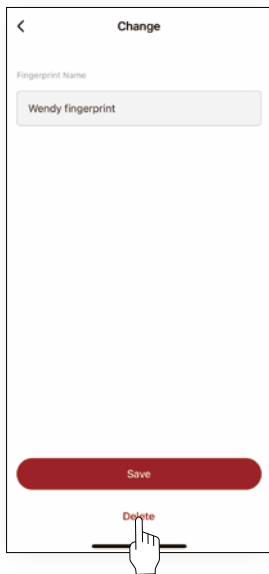

② Tap delete.

TROUBLESHOOTING

Q: How to reset the K02?

A: Long press the button on the Interior Knob until you hear the buzzer.

A: Please select "restore factory setting" or "Delete device" by GeekSmart APP.

Q: Does K02 work with third-party accessories such as single latch?

A: It is recommended to use the original accessories for best performance and stability.

Q: What notification will I receive when the battery is low?

A: After the fingerprint and mobile APP are successfully unlocked (the buzzer beeps once, the fingerprint reader flashes green and then flashes red).

When you unlock the device through the mobile App, you will receive a push notification message with low battery warning.

Q: How can I unlock K02 if battery runs out?

A: Connect a power bank to the knob with type-C cable as to activate for emergency access.

A: Press the screw in the back of the Interior knob, the fingerprint reader cover will come out for you to easily pull and turn. Pull out the fingerprint reader cover, turn the key 90° to unlock, then turn the exterior knob to unlock the door.

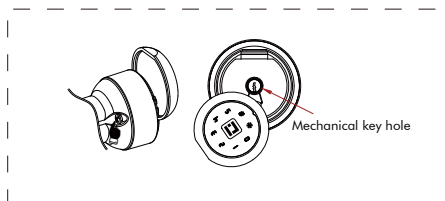

Important Note:

Please keep at least one key in secure location elsewhere as an extra precaution.



FCC WARNING

Any Changes or modifications not expressly approved by the party responsible for compliance could void the user's authority to operate the equipment.

Note:

This equipment has been tested and found to comply with the limits for a Class B digital device, pursuant to part 15 of the **FCC** Rules. These limits are designed to provide reasonable protection against harmful interference in a residential installation. This equipment generates uses and can radiate radio frequency energy and, if not installed and used in accordance with the instruction, may cause harmful interference to radio communications. However, there is no guarantee that interference will not occur in a particular installation. If this equipment does cause harmful interference to radio or television reception, which can be determined by turning the equipment off and on, the user is encouraged to try to correct the interference by one or more of the following measures:

- Reorient or relocate the receiving antenna.
- Increase the separation between the equipment and receiver.
- Connect the equipment into an outlet on a circuit different from that to which the receiver is connected.
- Consult the dealer or an experienced radio/TV technician for help.

This device complies with part 15 of the **FCC** Rules. Operation is subject to the following two conditions: (1) This device may not cause harmful interference, and (2) this device must accept any interference received, including interference that may cause undesired operation.

SPECIFICATIONS

Technical Parameters		
No.	Name	Parameter Description
1	USB	Type-C/ 5V2A
2	Fingerprints max	18
3	Low power warning	4.8V±0.2
4	Voltage range	4.5~6.5V
5	Stand-by current	<90uA
6	Working current	<250mA
7	Unlock time	≈1.5 sec
8	Range of working Temperature	14°F-131°F
9	Door thickness	1 ³ / ₈ "~2 ¹ / ₈ " (35-54mm)
10	Material	Allumium alloy
11	Power	4*AAA alkaline batteries



Q: If I order 3 locks will anyone else have the same keys?

A: Each set of locks is keyed differently.

Q: Accidentally deleted the lock from the app, what should I do?

A: 1. You delete the lock in the app, but the lock is not emptied.

Please RESET the lock.

2. Add again on the GeekSmart APP.

Q: My bluetooth won't connect, what should I do?

A: 1. Upgrade to the latest version of the firmware, authorize Bluetooth in the phone settings to allow access to the Geek Smart App.

2. Try to connect again.

3. If the connection is still not smooth, please contact our after-sale service.

Q: What notification will I receive when the battery is low?

A: When you use fingerprint or GeekSmart APP to unlock, the LED Indicator will flashes green and then flashes red.

A: The remaining power can provide about 500 times to unlock.

Please replace battery in time.

Q: How to enable passage mode?

A: 1. Press set button on Interior Knob, then unlock the knob by fingerprint, after buzzer beeps, passage mode enabled.

2. Or you can enter "Setting" page in the APP, enable the passage mode.

Q: How to disable passage mode?

A: 1. Press set button on Interior knob, the passage mode will be disabled.

2. Or you can enter "Setting" page in the APP, disable the passage mode.

Q: What is the difference between administrator/user?

A: The first user to add the knob by GeekSmart APP member is administrator, other members are users.

Administrator fingerprint can unlock even in the security mode, but user cannot unlock in the security mode.



GeekTale

Bring The Future Home

GEEK TECHNOLOGY CO., LTD
120 Route 46 West,
Parsippany, NJ 07054,
Toll Free
1-844-801-8880