

Portable Bluetooth CD Music System with Cassette and Digital AM/FM Radio



MODEL: CD-785

USER MANUAL

PLEASE READ THIS USER MANUAL COMPLETELY BEFORE OPERATING THIS
UNIT AND RETAIN THIS BOOKLET FOR FUTURE REFERENCE

WARNING

TO PREVENT FIRE OR SHOCK HAZARD, DO NOT USE THIS PLUG WITH AN EXTENSION CORD, RECEPTACLE OR OTHER OUTLET UNLESS THE BLADES CAN BE FULLY INSERTED TO PREVENT BLADE EXPOSURE. TO PREVENT FIRE OR SHOCK HAZARD, DO NOT EXPOSE THIS APPLIANCE TO RAIN OR MOISTURE.

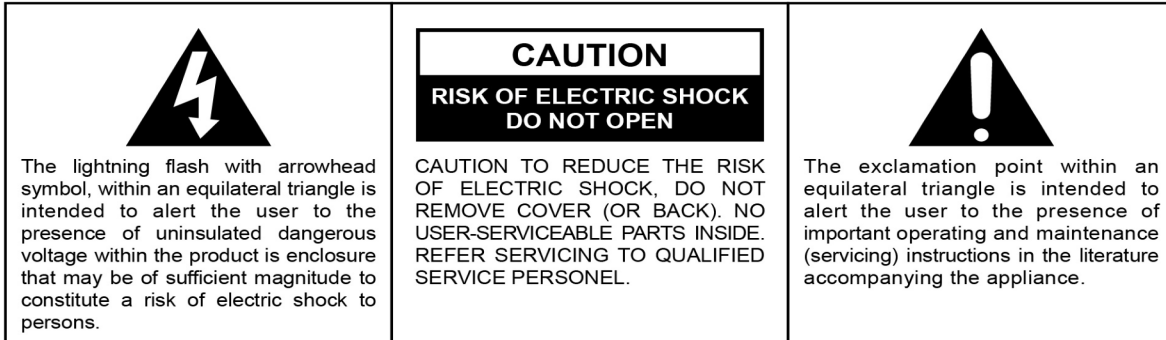

The Caution Marking is located at the back enclosure of the apparatus.
The Rating plate is located at the bottom enclosure of the apparatus

IMPORTANT SAFETY INSTRUCTIONS

1. Read these instructions.
2. Keep these instructions.
3. Heed all warnings.
4. Follow all instructions.
5. Do not use this apparatus near water.
6. Clean only with dry cloth.
7. Do not block any ventilation openings. Install in accordance with the manufacturer's instructions.
8. Do not install near any heat sources such as radiators, heat registers, stoves, or other apparatus (including amplifiers) that product heat.
9. Do not defeat the safety purpose of the polarized or grounding-type plug. A polarized plug has two blades with one wider than the other. A grounding type plug has two blades and a third grounding prong. The wide blade or the third prong is provided for your safety. If the provided plug does not fit into your outlet, consult an electrician for replacement of the obsolete outlet.
10. Protect the power cord from being walked on or pinched particularly at plugs, convenience receptacles, and the point where they exit from the apparatus.
11. Only use attachments/accessories specified by the manufacturer.
12. Use only with a cart, stand, tripod, bracket, or table recommended by the manufacturer, or sold with the product. When a cart is used, use caution when moving the cart/apparatus combination to avoid injury from tip-over.
13. Unplug this apparatus during lightning storms or when unused for a long period of time.
14. Refer all servicing to qualified service personnel. Servicing is required when the apparatus has been damaged in any way, such as power-supply cord or plug is damaged, liquid has been spilled or objects have fallen into the apparatus, the apparatus has been exposed to rain or moisture, does not operate normally, or has been dropped.
15. This appliance shall not be exposed to dripping or splashing water and that no object filled with liquids such as vases shall be placed on the apparatus.



16. Do not overload wall outlet. Use only power source as indicated.
17. Use replacement part as specified by the manufacturer.
18. Upon completion of any service or repairs to this product, ask the service technician to perform safety checks.
19. Power Sources - This product should be operated only from the type of power source indicated on the marking label. If you are not sure of the type of power supply to your home, consult your product dealer or local power company. For products intended to operate from battery power, or other sources, refer to the operating instruction.
20. Object and Liquid Entry - Never push objects of any kind into this product through openings as they may touch dangerous voltage points or short-out parts that could result in a fire or electric shock. Never spill liquid of any kind on the product.
21. Damage Requiring Service - Unplug this product from the wall outlet and refer servicing to qualified service personnel under the following conditions:
 - a) When the power-supply cord or plug is damaged,
 - b) If liquid has been spilled, or objects have fallen into the product,
 - c) If the product has been exposed to rain or water,
 - d) If the product does not operate normally by following the operating instructions. Adjust only those controls that are covered by the operating instructions as an improper adjustment of other controls may result in damage and will often require extensive work by a qualified technician to restore the product to its normal operation.
 - e) If the product has been dropped or damaged in any way, and
 - f) When the product exhibits a distinct change in performance - this indicates a need for service.
22. Mains plug is used as disconnect device and it should remain readily operable during intended use. In order to disconnect the apparatus from the mains completely, the mains plug should be disconnected from the mains socket outlet completely.
23. The (battery or batteries or battery pack) shall not be exposed to excessive heat such as sunshine, fire or the like.
24. Excessive sound pressure from earphones and headphone can cause hearing loss.
25. Minimum distances of 4 inches around the apparatus for sufficient ventilation.
26. The ventilation should not be impeded by covering the ventilation openings with items, such as newspapers, table-cloths, curtains, etc.
27. No open flame sources, such as lit candles, should be placed on the product.
28. The use of apparatus in moderate climates.
29. Attention should be drawn to the environmental aspects of battery disposal.

This symbol indicates that this product incorporates double insulation between hazardous mains voltage and user accessible parts.



CAUTION:
TO PREVENT ELECTRIC SHOCK, MATCH WIDE BLADE OF PLUG
TO WIDE SLOT. FULLY INSERT THE PLUG TO MAIN POWER
SOCKET.

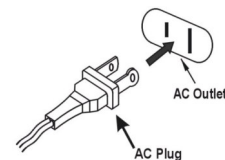

SAVE THESE INSTRUCTIONS

COMPLIANCE WITH FCC REGULATIONS

FCC ID: 2AB4KMETYH1480

This device complies with Part 15 of the FCC Rules. Operation is subject to the following two conditions:

- (1) This device may not cause harmful interference, and
- (2) This device must accept any interference received, including interference that may cause undesired operation.

This equipment has been tested and found to comply with the limits for a Class B Digital Device, pursuant to Part 15 of the FCC Rules. These limits are designed to provide reasonable protection against harmful interference in a residential installation. This equipment generates uses and can radiate radio frequency energy and, if not installed and used in accordance with the instructions, may cause harmful interference to radio communications.

However, there is no guarantee that interference will not occur in a particular installation. If this equipment does cause harmful interference to radio or television reception, which can be determined by turning the equipment off and on, the user is encouraged to try to correct the interference by one or more of the following measures:

- Reorient or relocate the receiving antenna.
- Increase the separation between the equipment and receiver.
- Connect the equipment into an outlet on a circuit different from that to which the receiver is connected.
- Consult the dealer or an experienced radio/TV technician for help.
-

WARNING: Changes or modifications to this unit not expressly approved by the party responsible for compliance could void the user's authority to operate the equipment.

PROTECT YOUR FURNITURE

This system is equipped with non-skid rubber 'feet' to prevent the product from moving when you operate the controls. These 'feet' are made from non-migrating rubber material specially formulated to avoid leaving any marks or stains on your furniture. However certain types of oil based furniture polishes, wood preservatives, or cleaning sprays may cause the rubber 'feet' to soften, and leave marks or a rubber residue on the furniture.

To prevent any damage to your furniture we strongly recommend that you purchase small self-adhesive felt pads, available at hardware stores and home improvement centers everywhere and apply these pads to the bottom of the rubber 'feet' before you place the product on fine wooden furniture.

CAUTION

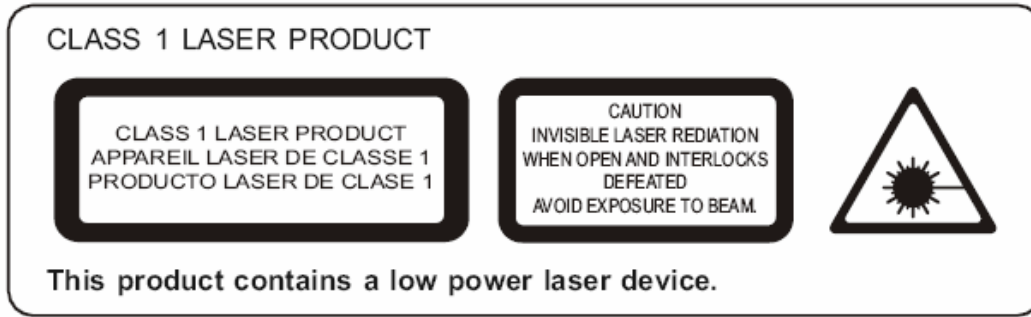

Follow the advice below for safe operations.

ON PROTECTION AGAINST LASER ENERGY EXPOSURE

- As the laser beam used in this compact disc player is harmful to the eyes, do not attempt to disassemble the casing.
- Stop operation immediately if any liquid or solid object should fall into the cabinet.
- Do not touch the lens or poke at it. If you do, you may damage the lens and the player may not operate properly.
- Do not put anything in the safety slot. If you do, the laser diode will be ON when the CD door is still open.
- If the unit is not to be used for a long period of time, make sure that all power sources are disconnected from the unit. Remove all batteries from the battery compartment.
- This unit employs a laser. The use of controls or adjustment or performance of procedures other than those specified here may result in exposure to hazardous radiation.

Should any trouble occur, remove the power source and refer servicing to qualified personnel.

DEAR JENSEN® CUSTOMER

Selecting fine audio equipment such as the unit you've just purchased is only the start of your musical enjoyment. Now it's time to consider how you can maximize the fun and excitement your equipment offers. This manufacturer and the Electronic Industries Association's Consumer Electronics Group want you to get the most out of your equipment by playing it at a safe level. One that lets the sound come through loud and clear without annoying blaring or distortion and, most importantly, without affecting your sensitive hearing. Sound can be deceiving. Over time your hearing "comfort level" adapts to higher volumes of sound. So what sounds "normal" can actually be loud and harmful to your hearing. Guard against this by setting your equipment at a safe level BEFORE your hearing adapts.

To establish a safe level:

- Start your volume control at a low setting.
- Slowly increase the sound until you can hear it comfortably and clearly, and without distortion.
- Once you have established a comfortable sound level: Set the dial and leave it there. Taking a minute to do this now will help to prevent hearing damage or loss in the future. After all, we want you listening for a lifetime.

We Want You Listening For a Lifetime

Used wisely, your new sound equipment will provide a lifetime of fun and enjoyment. Since hearing damage from loud noise is often undetectable until it is too late, this manufacturer and the Electronic Industries Association's Consumer Electronics Group recommend you avoid prolonged exposure to excessive noise.



Customer's Record:

The serial number of this product is found on its bottom cover. You should note the serial number of this unit in the space provided as a permanent record of your purchase to aid in identification in the event of theft or loss.

Model Number: CD-785

Serial Number:

LOCATION OF CONTROLS

MAIN UNIT

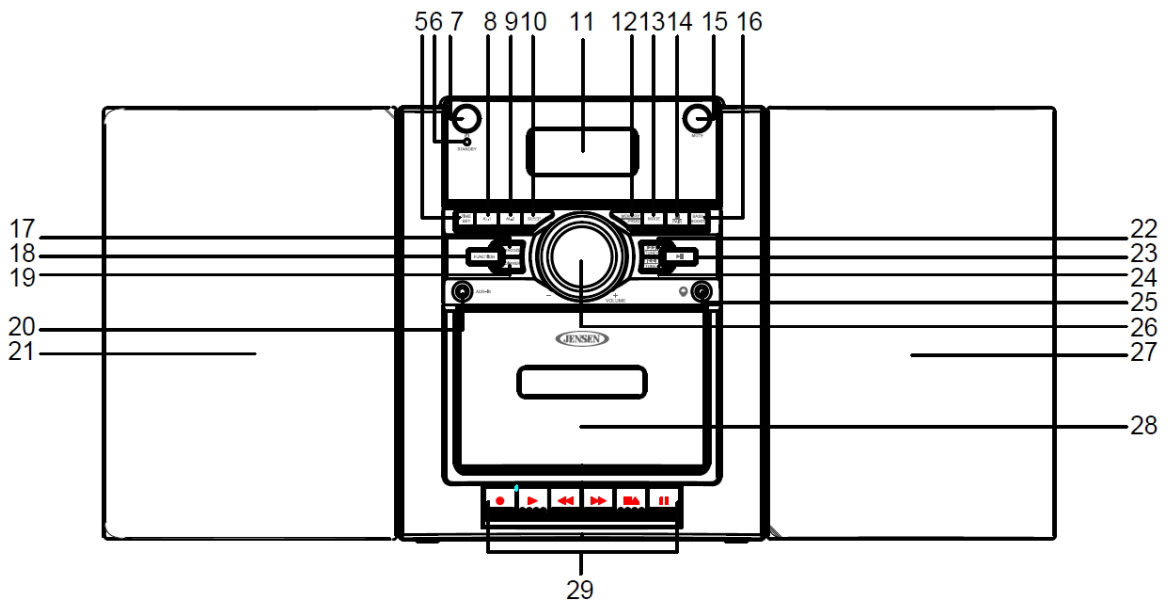
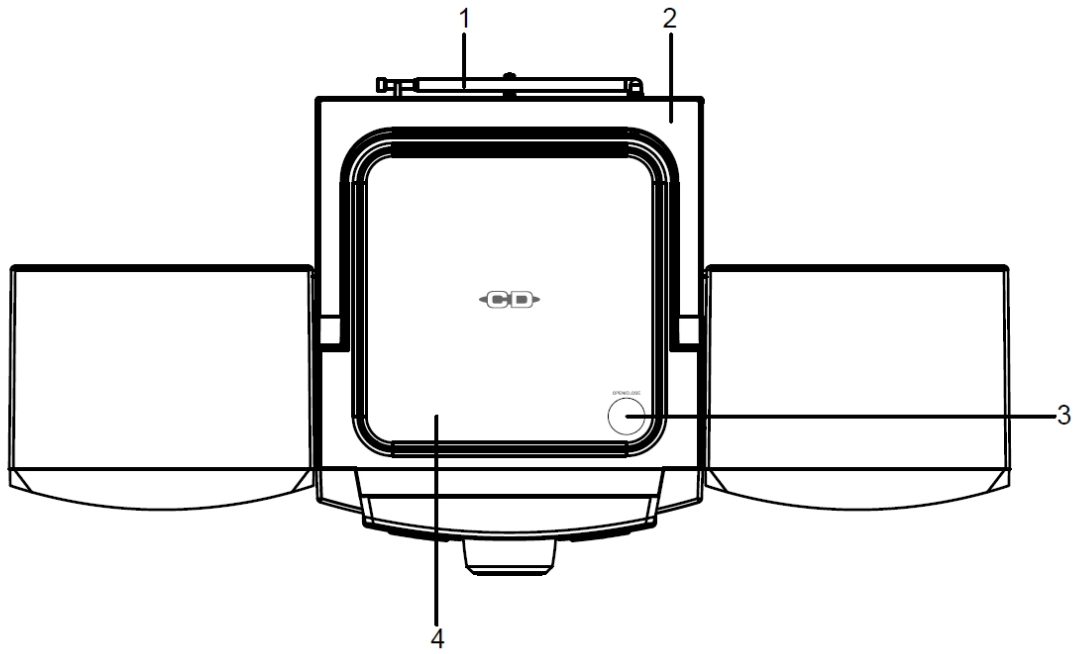

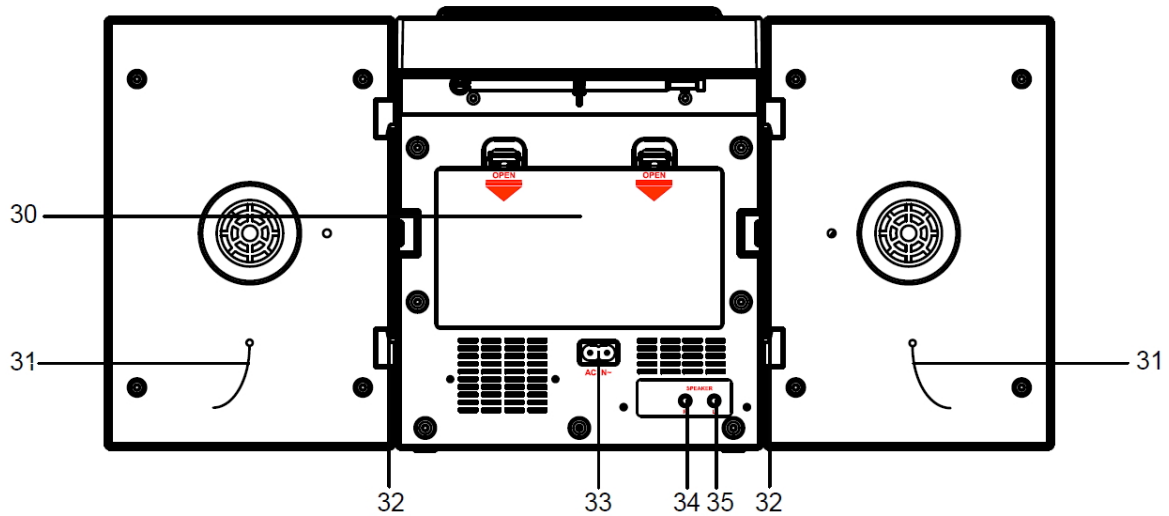

1	FM TELESCOPE ANTENNA	22	CD ►► / TUNE+ BUTTON
2	FOLDABLE HANDLE	23	CD PLAY/PAUSE ► BUTTON
3	CD DOOR OPEN/CLOSE SWITCH	24	CD ◀◀ / TUNE- BUTTON
4	CD COMPARTMENT	25	HEADPHONE JACK
5	TIME SET BUTTON	26	VOLUME CONTROL
6	STANDBY LED INDICATOR	27	RIGHT SPEAKER
7	POWER ⏻ BUTTON	28	CASSETTE COMPARTMENT
8	ALARM 1 BUTTON	29	CASSETTE CONTROL BUTTONS
9	ALARM 2 BUTTON		RECORD ● BUTTON
10	SLEEP BUTTON		PLAY ► BUTTON
11	LCD DISPLAY		REWIND ◀◀ BUTTON
12	MEMORY/PROG BUTTON		FAST FORWARD ►► BUTTON
13	MODE BUTTON		STOP / EJECT ■▲ BUTTON
14	CD STOP / BLUETOOTH PAIR BUTTON		PAUSE BUTTON
15	MUTE BUTTON	30	BATTERY DOOR
16	BASS BOOST BUTTON	31	SPEAKER CABLES
17	SNOOZE BUTTON	32	SPEAKER LOCKS
18	FUNCTION BUTTON	33	AC IN
19	DIMMER BUTTON	34	SPEAKER OUT R JACK
20	AUX IN JACK	35	SPEAKER OUT L JACK
21	LEFT SPEAKER		

REMOTE CONTROL

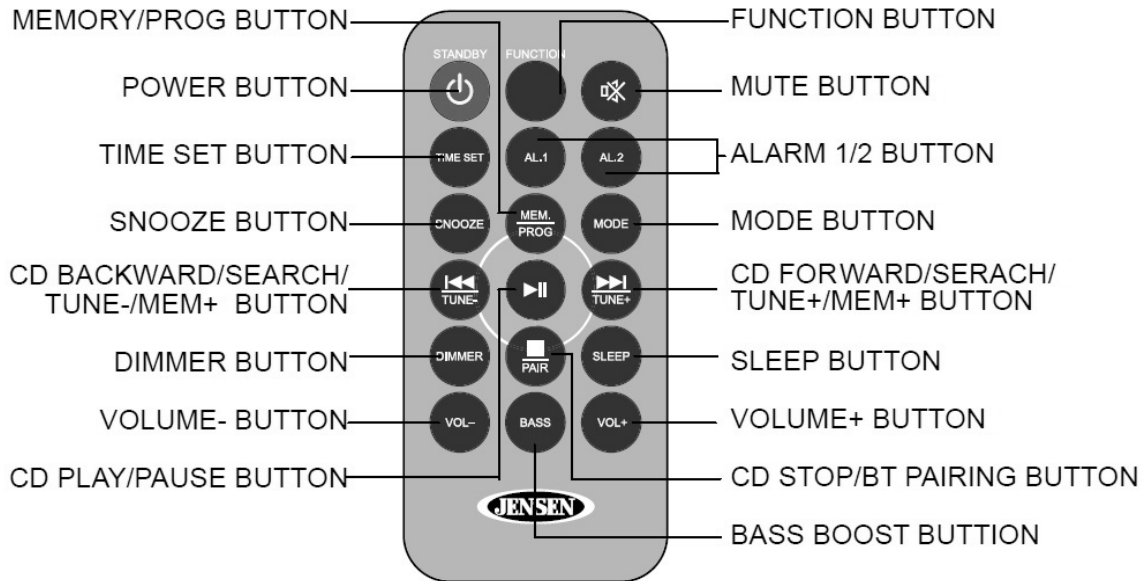

The remote control operates on one CR2025 battery (included). To activate the remote control, remove the insulation tab inserted in the battery compartment. When the operation of the remote control becomes intermittent or weak, replace the original battery with a new 3-volt lithium battery.

1. Slide out the battery holder from the remote control case.
2. Replace the 3V CR2025 battery. Be sure the battery is installed correctly. The remote will not work if the battery is installed with the wrong polarity.

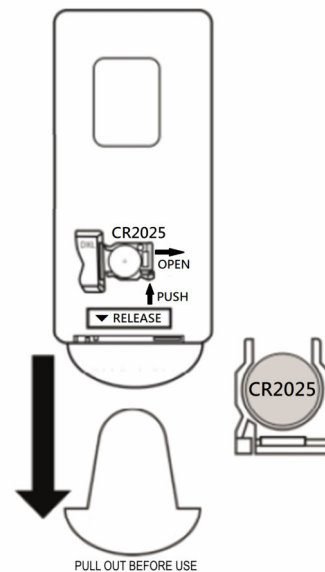

WARNING

DO NOT INGEST BATTERY, CHEMICAL BURN HAZARD

The remote control supplied with this product contains a coin/button cell battery. If the coin/button cell battery is swallowed, it can cause severe internal burns in just 2 hours and can lead to death.

Keep new and used batteries away from children. If the battery compartment does not close securely, stop using the product and keep it away from children.

If you think batteries might have been swallowed or placed inside any part of the body, seek immediate medical attention.

GETTING STARTED

The CD-785 features removable speakers, so it can be used on a shelf or desktop with speakers detached, or as a portable unit with speakers attached.

SPEAKER CONNECTION

NOTE:

Make sure that the power is switch off when connect or disconnect the speakers. Make sure that the speakers are plugged into the correct jacks.

USING THE CD-785 AS A DESKTOP PLAYER

1. Place one speaker on the left side of the main unit and plug the speaker wire from the Left Speaker into the SPEAKER OUT L JACK (#35) located on the rear panel of the main unit.
2. Place the other speaker on the right side of the main unit plug the speaker wire from the Right Speaker into the SPEAKER OUT R JACK (#34) located on the rear panel of the main unit.

USING THE CD-785 AS A PORTABLE PLAYER

1. Place the Left speaker onto the tracks located on the left hand side of main unit. Slide the speaker along the main unit, from front to back, until a “click” sound is heard indicating that the speaker is locked into position.
2. Place the Right speaker onto the tracks located on the right hand side of main unit. Slide the speaker along the main unit, from front to back, until a “click” sound is heard indicating that the speaker is locked into position.
3. Plug the left speaker cable into the SPEAKER OUT L JACK (#35) and the right speaker cable into the SPEAKER OUT R JACK (#34).
4. To detach the speaker, push down the SPEAKER LOCK (#32), hold the speaker box and pulling it toward to detach it.

NOTE: Make sure that the speakers are plugged into the correct jacks.



POWER SOURCES

This unit operates using standard 120V~ 60Hz AC household power or 8 “D” size (UM-1) batteries (Not included).

A. AC POWER CONNECTION

1. Plug the AC power cord into a standard 120V~ 60Hz AC wall outlet, Standby mode LED lights.

NOTE: If you were operating the unit on battery power (AC cord disconnected), you must place the unit in Standby mode, STANDBY LED INDICATOR (#6) turned on before plugging in the AC power cord. If not, you may experience an interruption in power while plugging in the cord.

2. Tap the POWER  BUTTON (#7) to turn on the unit, STANDBY LED INDICATOR (#6) goes off and the display will show the current operation mode.
3. Tap the FUNCTION BUTTON (#18) repeatedly to change the operation mode.
4. Tap POWER  BUTTON (#7) to switch the unit into “STANDBY” mode after you finish listening. The STANDBY LED INDICATOR (#6) will turn on.
5. When the unit is operated from AC power source, the internal battery source will automatically be disconnected.

B. BATTERY OPERATION

NOTE: For best performance and longer operating time, we recommend the use of alkaline-type batteries.

1. Remove the BATTERY DOOR (#30) on the back of the unit.
2. Follow the marked polarities and install 8 X "D" size (UM-1) batteries.
3. Replace the BATTERY DOOR (#30).

NOTES:

- The Clock and radio presets will be lost if the installed batteries drain after a period of time. If this occurs, you will need to reset the FM presets.
- To avoid the clock setting and radio preset lost, don't disconnect the AC power when you replace the batteries.

IMPORTANT: Be sure that the batteries are installed correctly. Wrong polarity may damage the unit.

BATTERY CARE

- Batteries shall not be exposed to excessive heat such as sunshine, fire or the like.
- Be sure that the batteries are installed correctly. Wrong polarity may damage the unit.
- Do not mix old and new batteries.
- Do not mix alkaline, standard (carbon-zinc) or rechargeable (nickel-cadmium) batteries.
- Only batteries of the same or equivalent type as recommend are to be used.
- If the unit is not to be used for an extended period of time, remove all batteries. Old or leaking battery can cause damage to the unit and may void the warranty.
- Do not dispose batteries in fire. Batteries may leak or explode.
- Danger of explosion if battery is incorrectly replaced.

BATTERY REPLACEMENT

When the output sound of this unit becomes distorted, the batteries are weak. You need to replace all the exhausted batteries at the same time as soon as possible to avoid battery leakage.

STANDBY MODE

Standby Mode is when the unit is first plugged into an AC power source (display flashing), or after all the settings have been made and the time is showing on the display. The radio, CD player, Bluetooth, cassette and Aux-in modes are all off, no buttons are pressed and no alarms are sounding.

SETTING THE CLOCK

The LCD DISPLAY (#11) will flash when the unit is plugged in for the first time. The unit is now in standby mode.

Setting the Time:

1. In standby mode, press and hold the TIME SET BUTTON (#5) until the hour digits of the clock display begin to flash.
2. Repeatedly tap the **◀◀** BUTTON (#24) or **▶▶** BUTTON (#22) to set the hour. Press and hold the buttons for fast advance/reverse setting. Make sure the correct AM or PM time is selected when setting the hour.



Note: The PM ICON is located in the left part of the LCD DISPLAY (#11). The PM ICON will light when the hour digits selected are for PM time. The PM ICON will be off when the hour digits selected are for AM time.

3. Press the TIME SET BUTTON (#5) to confirm the time and the minute digits will flash.
4. Repeatedly tap the **◀◀** BUTTON (#24) or **▶▶** BUTTON (#22) to set the minute. Press and hold the buttons for fast reverse/advance setting.
5. Tap the TIME SET BUTTON (#5) to confirm and complete the setting. The display will stop flashing.





ALARM OPERATION

Setting the alarms:

1. In standby mode, press and hold the ALARM 1 BUTTON (#8), the hour of the alarm time will flash.
2. Tap the **▶▶** BUTTON (#22) or **◀◀** BUTTON (#24) to set the hour. Press and hold the buttons for fast advance/reverse setting.
Note: Make sure the correct AM or PM time is selected when setting the hour.
3. Tap the ALARM 1 BUTTON (#8) to confirm the hour setting, the minute digits will flash to prompt for input.
4. Tap the **▶▶** BUTTON (#22) or **◀◀** BUTTON (#24) to set the minute. Press and hold the button for fast reverse/advance setting.
5. Tap the ALARM 1 BUTTON (#8) to confirm the minute setting.
6. Tap the ALARM 1 BUTTON repeatedly to select the wake up option (CD, ALARM or RADIO) and complete the ALARM 1 setting.
7. Setting the ALARM 2 time uses the same steps above, but using the ALARM 2 BUTTON (#9) in place of the ALARM 1 BUTTON (#8).

Note: The unit will automatically save the settings and return to Standby mode if you do not tap any button within 10 seconds.

Waking to Alarm - Turning wake to ALARM on:



1. A beeping Alarm will automatically turn on when the alarm time is reached. The corresponding ALARM 1  or ALARM 2  icon will flash.
2. The volume level of the alarm sound will gradually increase from low to high.
3. Press the SNOOZE BUTTON to temporarily turn off the alarm, or press the POWER  BUTTON (#7) to turn the alarm off.

If no buttons are pressed when the alarm is sounding, it will continue sounding for 60 minutes and then turn off automatically.

Review the Alarm time setting:

In standby mode, tap the ALARM 1 / ALARM 2 buttons once. The corresponding alarm indicator/alarm time and wake up option will flash alternately on the LCD DISPLAY (#11). The unit will automatically return to standby mode if no buttons are pressed within 5 seconds.

Setting the alarms ON/OFF:

1. In Standby mode, tap the ALARM 1 BUTTON (#8) twice to turn on Alarm 1. The ALARM 1  ICON on the LCD DISPLAY (#11) will turn on.
2. Tap the ALARM 1 BUTTON (#8) twice again to turn off the Alarm 1. The ALARM 1  ICON will be turned off.
3. Turning Alarm 2 on/off will use the same steps above, but using the ALARM 2 BUTTON (#9) in place of the ALARM 1 BUTTON (#8).

SNOOZE FUNCTION

When the alarm sounds, tap the SNOOZE BUTTON to temporarily turn off the alarm and activate the snooze function. The alarm will stop and turn on again 9 minutes later. This can be repeated when the alarm sounds again.

Notes:

- The corresponding alarm icon ( or ) will flash during the snooze period.
- To cancel the snooze period and the alarm, press the POWER  BUTTON (#7).

RADIO OPERATION

LISTENING TO RADIO

Manual Tuning

1. Tap the POWER  BUTTON (#7) to turn on the unit.
2. Press the FUNCTION BUTTON (#18) repeatedly to select FM or AM radio mode, “FM” or “AM” icon and the tuning frequency appears on the LCD DISPLAY (#11).
3. Tune to the required radio station by tap the TUNE+ BUTTON (#22) or TUNE- BUTTON (#24) repeatedly.
4. Turn the VOLUME CONTROL KNOB (#26) to the desired volume level.

Auto Tuning

1. Press and hold the TUNE+ BUTTON (#22) or TUNE- BUTTON (#24) 1-2 seconds until frequency readout on the display begins to scan and then release the button. The tuner will stop scanning when it receives the next or previous broadcasting station of adequate signal strength.
2. Turn the VOLUME CONTROL KNOB (#26) to the desired volume level.

Hints for Best Reception:

FM: the TELESCOPIC FM ANTENNA (#1) should be fully extended and rotated to obtain the best possible station reception.

AM: the receiver has a built-in am bar antenna. If AM reception is weak, slightly rotating or re-positioning the unit will usually improve the AM reception

NOTE: Automatic tuning depends on the signal strength of the broadcasting station, so weak stations may be skipped. You can manually tune to find the weak stations if a station gets skipped. With strong signals, the tuner may stop before it reaches the actual broadcast frequency, so you may need to manually tune for the best reception

FM & FM-Stereo reception

- The “ST” indicator will light to show an FM stereo broadcast is being received.

Preset Radio Stations

You can store up to total of 20 FM and 20 AM radio stations in the memory.

1. Set to FM or AM mode
2. Turn to the desired radio station by “MANUAL” or “AUTO” tuning method.
3. Press the MEMORY BUTTON (#12) to enable program mode, “P01” appears in display and flashing.
4. Press ►| BUTTON (#22) or |◄◄ BUTTON (#24) repeatedly to select the desired station memory for storage.
5. Press the MEMORY BUTTON (#12) again to confirm the setting.
6. Repeat step 2 to 5 to store other stations if necessary.

NOTE:





1. In AC power mode, the pre-set memories might be cancelled completely if the main power is unplugged. We recommend placing the system into standby mode for convenience and also to avoid having to reset the FM stations again. Or keep the batteries in the battery compartment.
2. There is a 5 second delay after programming, and after 5 seconds, the radio will return to normal tuner mode automatically.
3. You can overwrite a present station by storing another frequency in its place.

Recalling the Preset Stations

In FM or AM radio mode, tap the MEMORY BUTTON (#12) repeatedly to select the preset stations in order.

BLUETOOTH OPERATION

Pairing a Bluetooth enabled device with the CD-785.

1. Tap the POWER  BUTTON (#7) to turn on the unit.
2. Tap the FUNCTION BUTTON (#18) repeatedly to select Bluetooth mode.
3. “bt” will show on the LCD DISPLAY (#11) and the  icon will turn on and flash.
4. Turn on the Bluetooth function of your device and enable the search or scan function to find the CD-785.
5. Select the CD-785 from the device list when it appears on your device’s screen. If required, enter the pass code “0000” to pair (link) the CD-785 with your device.
6. If you are pairing (linking) your computer to the CD-785 using Bluetooth, you may need to set the CD-785 as your computer’s default sound device.
7. After pairing the CD-785 with your Bluetooth device successfully, the  icon will light steadily.
8. If you want the CD-785 to pair with another Bluetooth device, press and hold the BLUETOOTH PAIR BUTTON (#14) until the  icon flashes. The unit will go into Pairing/Discoverable mode.
9. Repeat steps 4 & 5. Now you can play music from your Bluetooth device wirelessly to the CD-785

CD OPERATION

NOTES:

- This player will not only play commercial CDs, but also self-complied CD-R/RW discs.
- Do not attempt to play CD-ROM, CDI, VCD, DVD or computer CDs.

PLEASE READ THIS IMPORTANT INFORMATION:

CD mechanisms used in devices like this are designed to read all commercial CDs. It will also read self-compiled CD-R/CD-RW discs, but it may take up to 10 seconds for the actual playback to begin. If playback does not start, it is likely due to the quality of the CD-R/RW disc and/or the compatibility of the CD compilation software. The manufacturer is not responsible for the playback quality of CD-R/RW discs. Do not attach a label or seal to either side of the CD-R/RW disc. It may cause a malfunction.

FOR WINDOWS USERS:



When using the “Burn a CD” feature to create an MP3 CD in Windows, you must select the “With a CD/DVD player” option when it asks “How do you want to use the disc?” The MP3 CD will not play on this unit if you select the “Like a USB flash drive” option or if the MP3 CD is not finalized.

LOADING THE DISC

1. Tap the POWER  BUTTON (#7) to turn on the unit.
2. Tap the FUNCTION BUTTON (#18) to select CD mode, the CD icon will show on the LCD DISPLAY (#11) and start to read.
3. Press the CD door OPEN/CLOSE switch to open the CD door, “OP” will show on the LCD DISPLAY (#11).
4. Place a CD with the printed side facing up inside the tray.
5. Press the CD door to close it.
6. CD search will be performed; the display will show the total number of tracks. If no CD installed or installed CD is not recognized, display will show “No”.

NOTE: CD searching will be performed every time when you switch to CD mode or if you close the CD door. All CD functions will start responding when the CD searching is completed.



● CD PLAY / PAUSE MODE

1. Press the  BUTTON (23) to start playback. The first track of the first disc will be played. The playing track's number and the time will show on the LCD DISPLAY (#11) alternately.
2. To interrupt, press the  BUTTON (23) once, the playing track's time will start flashing.
3. Press  BUTTON (23) again to resume playback.

● STOP MODE

1. If the STOP  button is pressed during PLAY or PAUSE, the system will go into stop mode and total tracks will show on the LCD DISPLAY (#11).

● SKIP MODE (SKIP UP /SKIP DOWN

1. During PLAY or PAUSE mode, tap the  BUTTON (#22), the player will go to next track and display the track no. and then remain the PLAY or PAUSE mode.
2. During PLAY or PAUSE mode, tap the  BUTTON (#24), the player will go back to the beginning of the track.
3. After step 2, tap the  BUTTON (#24) again will go to the previous track.

● SEARCH MODE

1. During PLAY mode, press and hold the ►► BUTTON (#22) for few seconds, it will start searching forward.
2. During play mode, press and hold the ◀◀ BUTTON (#24) for few seconds, it will start searching backwards.

● REPEAT PLAY

During CD playback, press the MODE BUTTON (#13) repeatedly to select a different playback mode:

REPEAT ONCE > REPEAT ALL > RANDOM > OFF

This function allows you to repeat 1 single track or repeat all tracks or play all tracks randomly in the disc.

NOTE: Repeat function is possible in normal or programmed playback.

CD PROGRAMMING

Up to 20 tracks can be programmed to be played in any required order from the CD.

1. Set in CD mode and press the STOP ■ BUTTON (#14).
2. Press the PROGRAM BUTTON (#12) to enable CD programming mode, PROG icon and program number "P01" will flash on the LCD DISPLAY (#11) to prompt for input.
3. Press the ►► BUTTON (#22) or ◀◀ BUTTON (#24) to select the desired track.
4. Press the PROGRAM BUTTON (#12) to confirm, program counter advances to "P02" and flash to prompt for input.
5. Repeat steps 3 to 4 to enter additional programs. The display will show "FU" when all the preset locations are full.
6. Press the ►|| button to start playback in order.
7. Press the ■ button to stop playback and press it twice to clear all programmed tracks. "PROG" icon will go off.

CASSETTE PLAYING AND RECORDING

GENERAL OPERATION

- | | |
|------------------------|--|
| STOP / EJECT ■▲ BUTTON | Press to stop all deck operation. Press again to open the cassette door. |
| FAST FORWARD ►► BUTTON | Press to start rapid tape winding forward direction. Press stop / eject key when the cassette spools stop turning. |
| REWIND ◀◀ BUTTON | Press to start rapid tape winding reverse direction. Press stop / eject key when the cassette spools stop turning. |
| PLAY ► BUTTON | Press to start playing tape. |
| PAUSE BUTTON | Press to stop tape operation temporarily. Press again to resume. |
| RECORD ● BUTTON | Press together with play key to start tape recording. |

PLAYBACK

1. Tap the POWER ⏻ BUTTON (#7) to turn on the unit.
2. Tap the FUNCTION BUTTON (#18) to select Cassette mode, the TAPE icon and "tAP" will show on the LCD DISPLAY (#11).
3. Put in the cassette tape.
4. Press PLAY ► BUTTON to active playback.
5. Adjust the VOLUME CONTROL (#26) to the desired level.
6. Use PAUSE || BUTTON when you want to stop playback temporarily.
7. Press STOP / EJECT ■▲ key when finished.

RECORDING

The cassette recorder features an Automatic Volume Level Control Recording System that prevents overloaded or distorted recordings. You can change the volume level as often as you like during the recording process. It will not have any effect on the volume level of the recording itself.

Insert a good quality blank tape into CASSETTE DECK with the exposed tape facing down and the full reel on the left side. Close the cassette door.

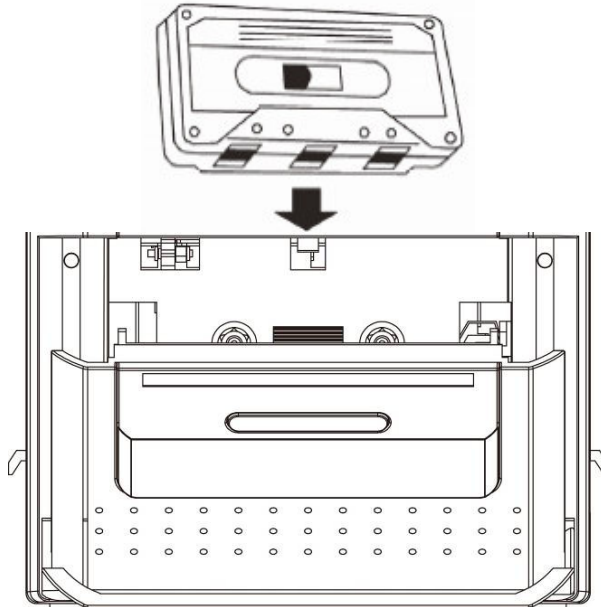

A. RECORDING FROM THE RADIO

1. Tap the POWER \odot BUTTON (#7) to turn on the unit.
2. Tap the FUNCTION BUTTON (#18) to select Radio mode and select AM or FM.
3. Tune to the desired station and insert a blank cassette tape in deck.
4. Press the RECORD \bullet & PLAY \blacktriangleright BUTTON to start recording.
5. Press the PAUSE \parallel BUTTON and then STOP/EJECT \blacksquare \blacktriangle BUTTON when finish.

B. RECORDING FROM A CD

1. Tap the POWER \odot BUTTON (#7) to turn on the unit.
2. Tap the FUNCTION BUTTON (#18) repeatedly to select CD mode.
3. Press the PAUSE \parallel BUTTON first and then RECORD \bullet & PLAY \blacktriangleright BUTTON at cassette. Recording function is now on STANDBY
4. Activate the CD player, and then press the PAUSE \parallel BUTTON at cassette to start recording.
5. To stop recording, press the STOP \blacksquare BUTTON on CD player first, then press the PAUSE \parallel BUTTON.

C. RECORDING FROM THE AUX IN

1. Tap the POWER \odot BUTTON (#7) to turn on the unit.
2. Tap the FUNCTION BUTTON (#18) repeatedly to select AUX mode.
3. Connect Line out or headphone out of your external audio device to the AUX IN JACK (#20) via a 3.5mm plug audio cable (not included). Insert a blank cassette tape into the deck.
4. Press the PAUSE \parallel BUTTON first and then RECORD \bullet & PLAY \blacktriangleright BUTTON at cassette. Recording function is now on STANDBY.
5. Press play button of your external audio device to start playback and then release PAUSE \parallel BUTTON at deck to start recording.
6. Press the PAUSE \parallel or STOP \blacksquare \blacktriangle BUTTON at deck when finish.

BASS BOOST

Press the BASS BOOST BUTTON (#16) to enable bass boost function if you want more bass effect when listening. BASS icon will light on the LCD DISPLAY #11). Press BASS BOOST BUTTON (#16) again to turn off bass boost function. BASS icon will be turned off.

AUXILIARY INPUT

This unit provides an auxiliary audio signal input jack for connecting external audio devices like MP3 players, CD players and older, non-dockable iPods (except iPod shuffle 3rd gen) so you can listen to your external source through the speakers of this system.

1. Use an audio cable (not included) with one 3.5 mm stereo plug on each end of the cable.
2. Plug one end into the AUX-IN jack on the main unit and the other end of the cable into the Line-out Jack or Headphone Jack of your external audio device.
3. Turn on the external audio device.
4. To select auxiliary audio input, press the FUNCTION button to select AUX mode.
5. The volume level can now be controlled through the main unit. Operate all other functions on the auxiliary device as usual.

Note:

- (1) If the Line Out Jack of your external device is connected, then you only need to adjust the volume control of this system. If the Headphone Jack of your external device is connected, then you may need to adjust both the volume control of your external device and the volume control of this system to find the most desirable volume setting.
- (2) Slide the MODE SWITCH to turn off the system when you finish listening. Don't forget to switch off the power on your external device as well.

SLEEP OPERATION

The SLEEP TIMER feature allows you to turn off the unit automatically after a designated time has elapsed.

1. Select CD, FM/AM, Bluetooth or AUX Mode and begin playing music from the selected source.
2. Tap the SLEEP BUTTON (#10) to enter sleep mode.
3. Repeatedly tap the SLEEP BUTTON (#10) to select the sleep timer 10 – 20 – 30 – 40 – 50 – 60 – 70 80 – 90 - OFF (in minutes). The unit will play for the selected length of time then turn off automatically.
4. To cancel the sleep timer, repeatedly tap the SLEEP BUTTON (#10) until the timer shows OFF.
5. To turn the unit "Off" before the selected length of time, press POWER  BUTTON (#7) at any time.

Note: Tap the SLEEP BUTTON (#10) once to check the remaining sleep time.

DIMMER OPERATION

Tap the DIMMER BUTTON (#19) repeatedly to select the brightness settings of the display (Low or High).

USE HEADPHONES (NOT INCLUDED)

Inserting the plug of your stereo headphones (not included) into the headphone jack will enable you to listen in private. When using headphones, the speakers will be disconnected.

Read this Important Information before Using Your Headphones

- 1.) Avoid extended play at very high volume as it may impair your hearing.
- 2.) If you experience ringing in your ears, reduce the volume or shut off the unit.
- 3.) Keep the volume at a reasonable level even if your headset is an open-air type designed to allow you to hear outside sounds. Please note that excessively high volume may still block outside sounds.

RESETTING

If the system does not respond or has erratic operation, you may have experienced an electrostatic discharge (ESD) or a power surge that triggered the internal computer to shut down automatically. If this occurs, unplug the power cord and remove all batteries. Wait for 3 minutes, then reinstall the batteries and plug in AC power again. Unit will be reset and all FM presets will be erased.

CARE AND MAINTENANCE

1. Do not subject the unit to excessive force, shock, dust or extreme temperature.
2. Do not tamper the internal components of the unit.
3. Clean your unit with a dry cloth. Solvent or detergent should never be used.
4. Avoid leaving your unit in direct sunlight or in hot, humid or dusty places.
5. Keep your unit away from heating appliances and sources of electrical noise such as fluorescent lamps or motors.

ABOUT CASSETTE TAPES

Whenever you record on a cassette any previously recorded material is erased as the new material is recorded. To prevent you from accidentally erasing material which you wish to save, blank cassettes are equipped with erase prevention tabs for each side of the tape. If the erase prevention tab for side A is removed, you cannot accidentally record on side A. The Record ● key cannot be depressed if the erase prevention tab on the cassette has been removed.

To prevent accidental erasing on side A of a cassette use a small screw driver or similar tool to break off the erase prevention tab for side A. This prevents the record key from locking.



If later you do wish to record on side A of the cassette, cover the tab opening with a piece of cellophane tape. This will allow the Record ● to function again.

CASSETTE CARE

Two common causes of trouble experienced when using cassettes are:

- 1) Tape Jamming – Leading to uneven speed in playback, and
- 2) Tape Tangling – Where the tape wraps itself around it's parts of the mechanism.

To reduce the likelihood of these problems occurring, the following precautions should be observed:

- Check that there are no loose layers of tape visible through the cassette center window (see Fig. 1). Take up any loose layers, using a pencil or hexagonal barrelled ballpoint pen, before inserting the cassette into the machine (see Fig.2)

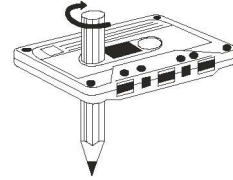

Fig. 2

If the cassette feels tight while performing operation shown (see Fig.2), the tape may be jamming due to ridges formed in the winding of the tape (visible through the center window). These may be removed, in most cases, by fast winding of the cassette from one end to the other and back again.

- Use only well-known brands of tape. Avoid use of C-120 cassettes.

Furthermore, do not expose cassettes to direct sunlight, dust or oil, and do not touch the tape surfaces.

HEAD CLEANING

The tape heads, pinch roller and capstan require periodic cleaning. This removes particles of the metal oxide coating that wear off the tape and accumulate on these parts and impair performance. Switch off the power, press the Stop/Eject \blacksquare ▲ key to open the cassette door, and press the Play ► key. Clean the tape heads, pinch roller and capstan with a soft cloth or cotton pad dampened in isopropyl alcohol or special tape head cleaner.

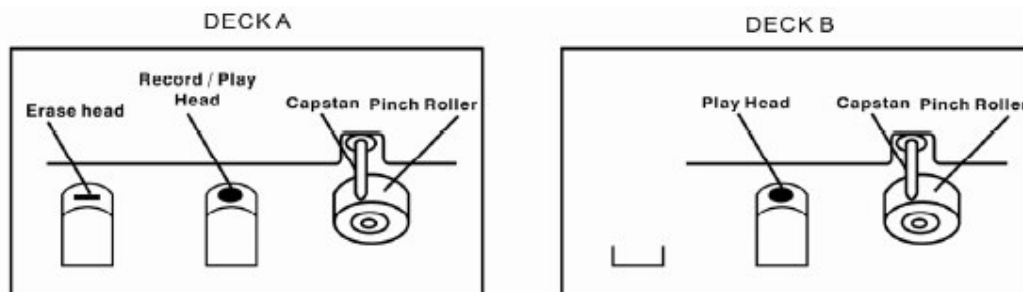

1. Avoid operating your unit under direct sunlight or in hot, humid or dusty places.
2. Keep your unit away from heating appliances and sources of electrical noise such as fluorescent lamps or motors.
3. For better Clock Display clarity, avoid operating the unit under direct sunlight or in strong room illumination.
4. Unplug the unit from the electrical power outlet immediately in case of malfunction.

COMPACT DISC CARE

- Handle the disc only by its edges. Never allow your fingers to come in contact with the shiny, unprinted side of the disc.
- Do not attach adhesive tape, stickers etc., to the disc label.
- Clean the disc periodically with soft, lint-free, dry cloth. Never use detergents or adhesive cleaners to clean the disc. If necessary, use a CD cleaning kit.
- If disc skips or gets stuck on a section of the disc, it is probably dirty or damaged (scratched).
- When cleaning the disc, wipe in straight lines from the center of the disc to the edge of the disc. Never wipe in circular motions.
- To remove a disc from its storage case, press down on the center of the case and lift the disc out, holding it carefully by the edges.
- Fingerprints and dust should be carefully wiped off the disc's recorded surface with a soft cloth. Unlike conventional records, compact discs have no grooves to collect dust and microscopic debris so gently wiping with a soft cloth should remove most particles.



CLEANING THE UNIT

- To prevent fire or shock hazard, disconnect your unit from the AC power source when cleaning.
- The finish on the unit may be cleaned with a dust cloth and cared for as other furniture, Use caution when cleaning and wiping the plastic parts.
- If the cabinet becomes dusty wipe it with a soft dry dust cloth. Do not use any wax or polish sprays on the cabinet.
- If the front panel becomes dirty or smudged with fingerprints it may be cleaned with a soft cloth slightly dampened with a mild soap and water solution. Never use abrasive cloths or polishes as these will damage the finish of your unit.

CAUTION: Never allow any water or other liquids to get inside the unit while cleaning.

TROUBLESHOOTING GUIDE

PROBLEM	POSSIBLE CAUSE	SOLUTION
The unit does not respond (no power)	The unit is disconnected from the AC outlet	Reconnect to the AC outlet.
	AC outlet is not functioning.	Plug another device into the same outlet to confirm the outlet is working.
	No batteries installed or installed batteries are exhausted.	Install 8 x "D" batteries or replace the exhausted batteries.
Noise or sound distorted on FM broadcast	Station not tuned properly for FM. Telescopic antenna is not fully extended.	Retune the FM broadcast station. Fully extend the FM telescopic antenna.
FM STEREO indicator does not light up	You have tuned to a mono station or the station is too weak.	Select another FM station or extend or rotate the telescopic antenna for best reception.
Sound is distorted	Volume level is set to high.	Decrease the volume.
	Sound source is distorted.	Try a different audio source such as a music CD.
CD Player does not play.	CD Mode is not selected.	Slide the FUNCTION switch to select CD mode.
	CD is not installed or installed incorrectly.	Press the CD onto spindle, printed side facing up.
CD skip while playing	Disc is dirty or scratched.	Wipe with cloth or another disc.
Unit gets warm after extended play at high volume	This is normal	Turn the unit off for a period of time or lower volume.

SPECIFICATION

Power: AC120V~ 60Hz 18W or
8 x 1.5V "D" (UM-1) size batteries

Remote Control 1 X 3V == CR2025

Frequency Range: FM 87.5 ~ 108 MHz
AM 520 – 1710 KHz



At Spectra, environmental and social responsibility is a core value of our business. We are dedicated to continuous implementation of responsible initiatives with an aim to conserve and maintain the environment through responsible recycling.

Please visit us at <http://www.spectraintl.com/green.htm> for more information on Spectra's green initiatives or to find a recycler in your area.

The Bluetooth® word mark and logos are registered trademarks owned by Bluetooth SIG, Inc. and any use of such marks by Spectra Merchandising Intl, Inc. is under license. Other trademarks and trade names are those of their respective owners.

90 DAY LIMITED WARRANTY AND SERVICE VALID IN THE U.S.A. ONLY

SPECTRA MERCHANDISING INTERNATIONAL, INC. warrants this unit to be free from defective materials or factory workmanship for a period of 90 days from the date of original customer purchase and provided the product is utilized within the U.S.A. This warranty is not assignable or transferable. Our obligation under this warranty is the repair or replacement of the defective unit or any part thereof, except batteries, when it is returned to the SPECTRA Service Department, accompanied by proof of the date of original consumer purchase, such as a duplicate copy of a sales receipt. You must pay all shipping charges required to ship the product to SPECTRA for warranty service. If the product is repaired or replaced under warranty, the return charges will be at SPECTRA's expense. There are no other express warranties other than those stated herein.

This warranty is valid only in accordance with the conditions set forth below:

1. The warranty applies to the SPECTRA product only while:
 - a. It remains in the possession of the original purchaser and proof of purchase is demonstrated.
 - b. It has not been subjected to accident, misuse, abuse, improper service, usage outside the descriptions and warnings covered within the user manual or non-SPECTRA approved modifications.
 - c. Claims are made within the warranty period.
2. This warranty does not cover damage or equipment failure caused by electrical wiring not in compliance with electrical codes or SPECTRA user manual specifications, or failure to provide reasonable care and necessary maintenance as outlined in the user manual.
3. Warranty of all SPECTRA products applies to residential use only and is void when products are used in nonresidential environment or installed outside the United States.

This warranty gives you specific legal rights, and you may also have other rights which vary from state to state. TO OBTAIN SERVICE please remove all batteries (if any) and pack the unit carefully and send it freight prepaid to SPECTRA at the address shown below. IF THE UNIT IS RETURNED WITHIN THE WARRANTY PERIOD shown above, please include a proof of purchase (dated cash register receipt) so that we may establish your eligibility for warranty service and repair of the unit without cost. Also include a note with a description explaining how the unit is defective. A customer service representative may need to contact you regarding the status of your repair, so please include your name, address, phone number and email address to expedite the process.

IF THE UNIT IS OUTSIDE THE WARRANTY PERIOD, please include a check for **\$40.00** to cover the cost of repair, handling and return postage. All out of warranty returns must be sent prepaid.

It is recommended that you contact SPECTRA first at 1-800-777-5331 or by email at custserv@spectraintl.com for updated information on the unit requiring service. In some cases, the model you have may be discontinued, and SPECTRA reserves the right to offer alternative options for repair or replacement.

SPECTRA MERCHANDISING INTERNATIONAL, INC.

4230 North Normandy Avenue,
Chicago, IL60634, USA. 1-800-777-5331

To register your product, visit the link on the website below to enter your information.
<http://www.spectraintl.com/wform.htm>