



OWNER'S MANUAL 2.5 gallon Wet/Dry Vac

For:
WD-2.5 L
WD-2.5 MA

CONGRATULATIONS!

You have just purchased a Koblenz® Vacuum Cleaner. Please read this manual carefully before operating the machine. Model and serial number may be found on the side of your vac. You should record both model and serial numbers and keep them in a safe place for future use. Save these instructions for future reference.

Electrical Rating: 120 V~ 60 Hz 3 A

CONTENT

Important safety instructions	Filter assembly	Filter maintenance
Warning	Wall mount assembly	Trouble shooting
Product description	Operation	Warranty
Polarized connection	Cleaning the tank	
Vac assembly	Storage	

IMPORTANT SAFETY INSTRUCTIONS

When using an electric vacuum cleaner, basic precautions should be followed.

Read all instructions before using this vacuum cleaner.

This vacuum cleaner is for domestic use only; it may be used for vacuuming wet or dry materials and as a blower.

WARNING

- To reduce the risk of fire, electric shock or injury:**
- 1. Do not use to pick up flammable or combustible liquids, such as gasoline or use in areas where such items may be present.
- 2. Use product only as described in this manual, use only manufacturer's recommended attachments.
- 3. Do not pick up anything that is burning or smoking; such as cigarettes, matches or hot ashes.
- 4. Do not leave vacuum plugged in. Unplug from outlet when not in use and before servicing. Turn unit off before unplugging.
- 5. Do not put any object into openings. Do not use with any opening blocked. Keep free of dust, lint, hair and anything that may reduce air flow.
- 6. Do not use without filter in place.
- 7. Do not allow vacuum to be used as a toy, or to run unattended at any time. If used near children, close supervision is necessary.
- 8. Do not store outdoors.
- 9. Do not use with a damaged cord or plug. If vacuum is not working as it should, or if it has been dropped, damaged, or submerged into water, return it to an authorized service center.
- 10. Do not pull or carry by cord, use cord as a handle, close a door on a cord or pull cord around sharp edges or corners, do not run vacuum over cord. Keep away from heated surfaces.
- 11. Do not unplug by pulling on cord. To unplug, grasp the plug, not the cord.
- 12. Do not unplug or vacuum with wet hands. Use extra care when cleaning stairs.
- 13. Keep hair, loose clothing, fingers and all parts of body away from openings and moving parts.
- 14. Never use vacuum cleaner as a pump.
- 15. If the line cord is damaged it must be replaced by the manufacturer or an authorized service center.
- 16. Connect to a properly grounded outlet only. See grounding instructions.
- 17. Do not use without filter in place. See filter instructions.
- 18. Do not pick up soot, cement, plaster or drywall dust. These are very fine particles that may pass through the filter and affect the performance of the motor or be exhausted back into the air.
- 19. Use special care when emptying heavily loaded tanks.
- 20. **WARNING!** Do NOT use this vacuum cleaner to vacuum lead paint debris because this may disperse fine lead particles into the air.

PRODUCT DESCRIPTION

- A) Ergonomic handle
- B) Power button
- C) Head
- D) Suction port
- E) Tank
- F) Air blower port
- G) Pick up nozzle
- H) Crevice tool
- I) Hose
- J) Wall Mount (available only for WD-2.5 L)

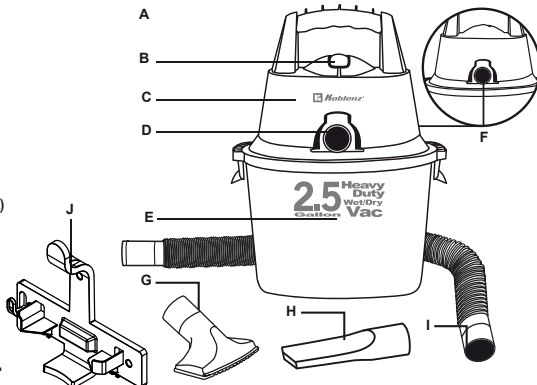

The appearance of the vacuum may change depending on the model. Not all accessories are included with all models. Check panel on box for more information.

POLARIZED CONNECTION

This appliance is for use on a 120 V~ circuit, and has a polarized plug as shown in figure A. A temporary adapter may be used to connect this plug to Non-polarized outlet. Temporary adapter should be used only until a properly polarized outlet can be installed by a qualified electrician.

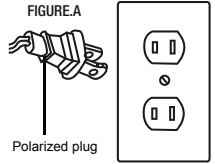

NOTE: In Canada, the use of a temporary adapter is not permitted by the Canadian Electrical Code.



WARNING

Improper connection of the equipment grounding conductor can result in a risk of electric shock. Check with a qualified electrician or service person if you are in doubt as to whether the outlet is properly grounded. Do not modify the plug provided with the appliance if it does not fit the outlet, have a proper outlet installed by a qualified electrician.

VAC ASSEMBLY



WARNING

Always unplug the vacuum from the outlet current, before performing any maintenance.

1. Close the locks on the side of the vacuum head with the tabs on the sides of the tank. (fig. 1)
2. Press the hose end into the suction port. (fig. 2)
3. Place the desired accessory on the other end of the hose.
4. Operate the power button and the vacuum cleaner will be ready for use.
5. To disconnect the hose from the vacuum cleaner, take it from the connected end, turn it half-turn and pull out.
6. Familiarize yourself with the controls on your vacuum cleaner.

Figure 1

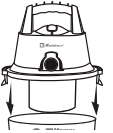
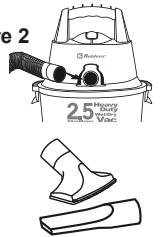

Figure 2



FILTER ASSEMBLY

Place filter above cage, and attach it with rubber band as shown in figure.

FILTER USE

1. This vacuum includes a paper filter for fine dust pick up.
2. The paper filter should always be removed for wet pick ups.
3. When vacuuming liquids the unit has a float that will rise to the top and shut off suction when the tank is full. This will increase the motor's rpm's.
4. Turn off the vac and dump out liquids to continue using the unit.

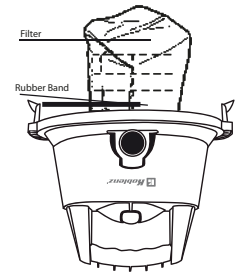

WALL MOUNT ASSEMBLY

Available only for WD-2.5 L

WARNING: Inadequate mounting could cause the unit to fall, causing damage and / or injury on it.

1. Select the install location in a wall space and / or find a strong surface to support the combined weight of the vacuum with a full tank of debris and accessories.
2. Secure the base to the desired surface with the included screws.
3. Once the base is positioned and secured to the desired surface, install the vacuum by aligning the grooves on each side of the base.
4. Always empty the tank and clean the filter before placing the vacuum cleaner on the wall base, otherwise it may cause the machine to fall, causing serious damage or injury.
5. Before removing the vacuum from the base to attach to the wall, check the click-n-lock strong tank latches.

Fig. 1

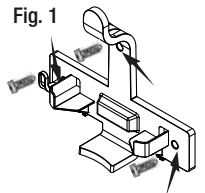

Fig. 2

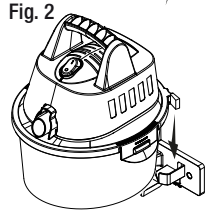
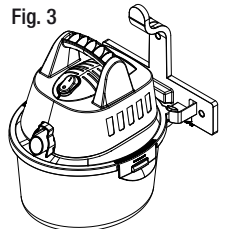

Fig. 3



Note: The supplied screws are suitable for wood mounting ONLY. Be sure to use proper fasteners to install the vacuum to a surface other than wood.

OPERATION



TO VACUUM SOLIDS

Never vacuum solids WITHOUT THE FILTER, this will damage the machine and invalidate the warranty.

Follow the instructions in "Filter Assembly" on this page.



AIR EXPULSION SYSTEM

Never eject air WITHOUT THE FILTER, this will damage the machine and invalidate the warranty.

This Koblenz vacuum cleaner also functions as an air blower. It has the capability to blow sawdust and other debris. It is excellent to use to blow dust and debris out of garages or off patios and driveways.

WARNING:

To avoid injury to bystanders, keep them clear of blowing debris. The operation of any utility vac can result in foreign objects being blown into the eyes, which can result in severe eye damage. Always wear safety goggles.

To use your Koblenz vacuum as a blower:

1. Locate the blowing port of your vac.
2. Insert flexible end of the hose into the blowing port.
3. Turn vac "ON" and you are ready to use your vac as a blower.

IMPORTANT:

To avoid damage to the unit do not let the motor run with a full tank.



TO VACUUM LIQUIDS NEVER VACUUM LIQUIDS WITH THE FILTER PLACED, this will damage the filter and invalidate the warranty.

Never vacuum liquids with the filter

1. Separate the top part of the vacuum cleaner.
2. Remove the filter from the motor grille.
3. Place the top part in its place, until you hear the click of the sides.
4. Place the hose in the suction port, then the accessory, turn on and go.

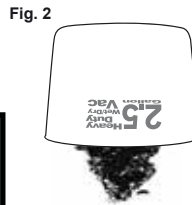
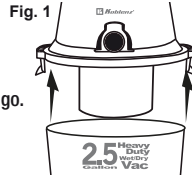

CLEANING THE TANK

1. Unplug power cord.
2. Remove the hose.
3. Unlock the side latches.
4. Place cover upside down on a clean surface.
5. Dump tank contents into a waste container.



WARNING

To avoid back injury or falls, do not lift a vac heavy with liquid or debris. Scoop or drain enough contents out to make the vac light enough to lift comfortably.

STORAGE

VAC AND ACCESSORIES

Before storing your vac, the dust tank should be emptied and cleaned.

Accessories should be stored on the tool caddy.

The vac should be stored in doors.

Always use the unit with the filter when vacuuming dry debris and dust.

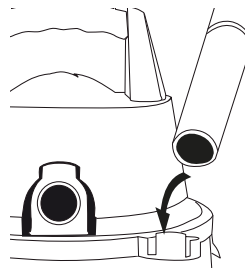

FILTER MAINTENANCE

WARNING:

To avoid injury from accidental starting, unplug power cord before changing or cleaning filter.

CLEANING:

Your filter should be changed often to maintain peak vac performance.

NOTE: This filter is made of high quality materials designed to stop very small particles of dust. Handle the filter carefully when removing to clean or installing it. Creases in the filter pleats may occur from installation but creases will not affect the performance of the filter.

Always use the unit with the filter when vacuuming dry debris and dust.

IMPORTANT: After cleaning the paper filter, check for holes. If any holes are found replace the filter immediately. Even small holes will permit dust to come out of the vac.

GENERAL MAINTENANCE

To keep your wet / dry vac looking its best, clean the outside with a cloth dampened with water and mild soap.

- To clean the tank:
1. Dump out debris.
 2. Wash drum thoroughly.
 3. Wipe out with dry cloth.



WARNING

To assure product SAFETY AND RELIABILITY, repairs and adjustments should be performed by a Koblenz Service Center, always using Koblenz replacement parts.

TROUBLE SHOOTING

PROBLEM	POSSIBLE CAUSE	POSSIBLE SOLUTION
Vacuum does not start	Not firmly plugged in.	Plug in firmly.
Low suction	Tank full.	Empty the tank.
	Filter is dirty.	Shake dust out of filter. Shake dust out of filter. See "Filter Maintenance" section.
	Obstruction in hose	Connect the hose to the blowing port until hose is clear.
	Motor head not installed correctly	Be sure that the motorhead seats properly on the tank.

WARRANTY

This warranty gives you specific legal rights, and may also have other rights that vary from state to state, province to province, or country to country.

Warranty coverage ends when the product becomes unusable for reasons other than defects in workmanship or material for a period of 5 years for domestic use. Limited warranty against manufacturing defects.

THIS WARRANTY SHALL NOT APPLY to any products or parts there of which have been damaged by tampering, misuse or abuse or which have been altered or repaired by an unauthorized person or service center.

THIS WARRANTY SHALL NOT APPLY to brushes or accessories since their life depends upon the amount of use.

THIS WARRANTY SHALL NOT APPLY when picking up dust and dry materials without filter in place.

THIS WARRANTY SHALL NOT APPLY when picking up liquids with filter in place.

THIS WARRANTY SHALL NOT APPLY when blowing sawdust and other debris without filter in place.

FOR REPAIR the inoperative machine must be delivered with shipping and delivery charges prepaid together with satisfactory evidence of the purchase date to an authorized service center or Thorne Electric Company at the address that appears below. Koblenz will either repair or replace, at its selection, all defective machines during the warranty period. Some states do not allow the exclusion or limitation of incidental or consequential damages, so the above limitation or exclusion may not apply to you.

This warranty is the sole and exclusive warranty for Koblenz products. No employee, agent, dealer, or other person is authorized to alter this warranty or make other warranty on behalf of Koblenz Electrica.

The foregoing obligations are in lieu of all other obligations and liabilities including negligence and state Koblenz's entire and exclusive liability and the purchaser's exclusive remedy. Koblenz will in no event be liable for any direct, indirect, special, incidental or consequential damages or losses what so ever. Koblenz's liability under no circumstances will exceed the contract price for the goods or parts for which liability is claimed.

Some states do not allow the exclusion or limitation of incidental or consequential damages, so the above limitation or exclusion may not apply to you.

U.S. Patent Numbers
US D 467,693S, US D467,694S,
US D 468,499S, US D470,633S.
Other patents pending.

Visit our website www.koblenz.com

Thorne Electric, Co.

P.O. Box 18636
San Antonio, TX.
78218-0363 U.S.A.
(210) 590-1226
1(800) 548-5741

Koblenz Eléctrica, S.A. de C.V.

Av. Ciencia No. 28,
Parque Industrial Cuamatla
Cuautitlán Izcalli,
Edo. de México, México,
C.P. 54730, Tel. (55) 5864-0300

Canada Call:

Tel: (210) 590 1226

PRINTED IN MEXICO