

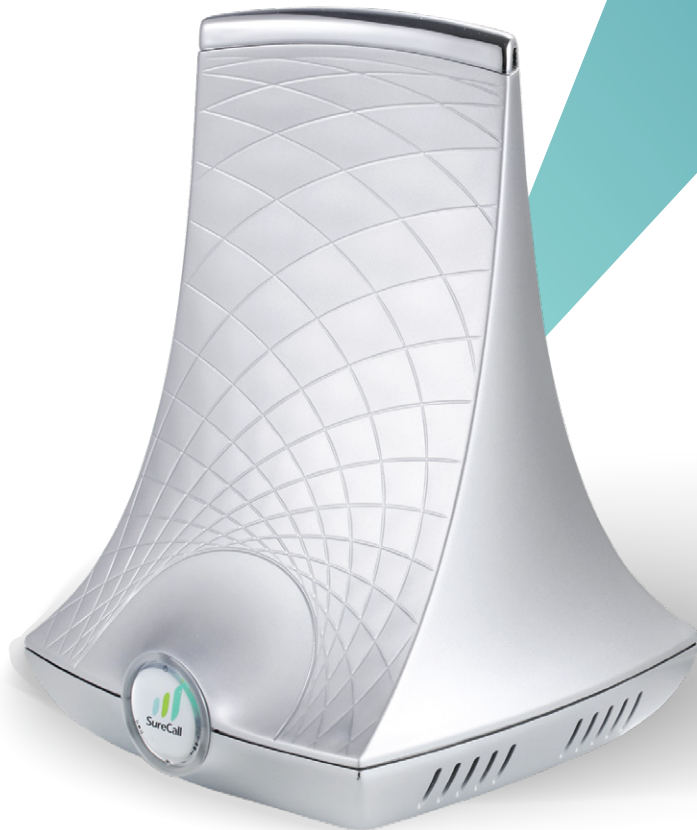

FLARE[®] iQ

Cellular signal booster kit with booster and integrated inside antenna



Questions?

✉ support@surecall.com | 📞 1-888-365-6283

Thank you for purchasing SureCall's Flare iQ cellular signal booster kit. SureCall's Flare iQ was specifically designed to eliminate frustrations over dropped calls and limited range by amplifying incoming and outgoing cellular signals in homes and offices.

If you have any questions during setup, please reach out to our US-based experienced support technicians:

Call: 1-888-365-6283

Email: support@surecall.com

Or, visit: www.surecall.com/support



Watch installation, optimization and troubleshooting techniques



@SureCall



Stay up to date with all things SureCall



Download the SureCall on the Google Play or Apple's App Store
Just search, "SureCall"

TABLE OF CONTENTS

OVERVIEW.....	3
Why indoor signal can be weak	3
How it works	3
Getting to know the Flare iQ Connect app.....	4
Package contents.....	5
Optional accessories	5
BEFORE INSTALLATION.....	6
Important. Before you begin.....	6
Taking signal measurements with your phone	7
Finding your closest cell tower.....	8
Tools needed	10
Grounding the outside antenna	10
Power requirements.....	10
Cable guidelines	10
INSTALLATION.....	11
Perform a Soft install	12
Step 1: Find area outside with strongest signal.....	12
Step 2: Install the outside antenna	13
Step 3. Place the Booster	14
Step 4: Connect to Power	15
Check and optimize system, if needed.....	15
App measurements	15
SYSTEM OPTIMIZATION.....	16
Antenna optimization	16
Antenna testing.....	16
TROUBLESHOOTING.....	17
SPECIFICATIONS.....	17
Kitting Information.....	18
CONSUMER GUIDELINES	19
WARRANTY	20
Three-year product warranty	20

OVERVIEW

Why indoor signal can be weak

There are several obstacles that can contribute to the poor reception you receive in your home:

- Distance to your carrier's cell phone tower
- Obstructions caused by terrain and foliage
- Building materials like low-E glass, metal and concrete

How it works

1. The outside antenna collects signal from the cell tower.
2. The outside antenna sends the signal to the booster through coax cable to the booster.
3. The booster amplifies the cell signal and rebroadcasts the signal indoors to all mobile devices within range.
4. The booster amplifies outgoing cell signal back to the tower.

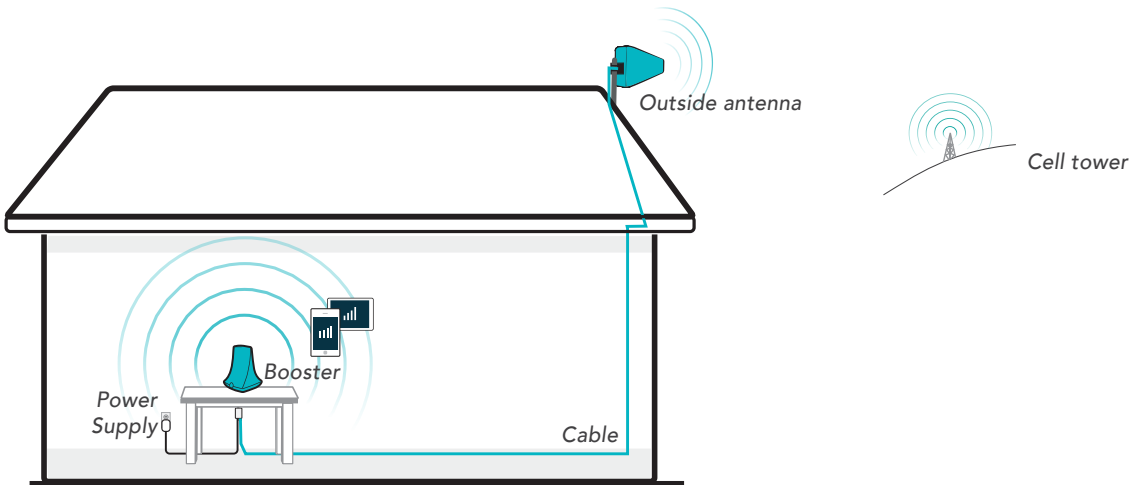

How the SureCall Flare iQ Booster Works

Getting to know the Flare iQ Connect app

Using the app to wirelessly connect to your booster provides you with real-time feedback while positioning both components of your booster system. Once you've downloaded the app and paired it with your booster, you will need to create a 'soft install' (page 12) before utilizing the readings found in your app.

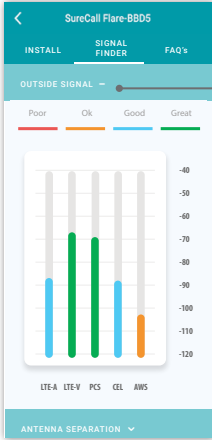

When testing for the best placement and angle for your outside antenna, see "OUTSIDE SIGNAL" tab on the app.

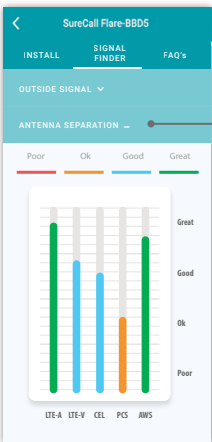

Then get real-time feedback on your booster placement. See "ANTENNA SEPARATION" tab on the app to verify there's enough separation between the components.

Package contents

Unpack all package contents. For missing or damaged items, contact your reseller.

Turn over the signal booster and record the model and serial number for reference:

Serial #: _____

Purchase Date: _____

Keep the carton and packing material to store the product in case you need to return. Your Flare iQ signal booster package includes the following items:

1. SureCall Flare iQ signal booster
2. Power supply
3. Cable for connecting the outside antenna to the signal booster
4. Outside Yagi antenna

1 Flare iQ Cellular Booster

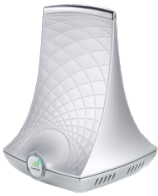

2 Power Supply



3 Indoor Cable (50 ft.)



4 Outside Yagi Antenna



Optional accessories

Looking to upgrade your SureCall booster? Boost your signal even further with these bestselling accessories:

	<p>SC-LP-75 Lightning arrester prevents damage from electrical surges</p>
--	--

	<p>SC-RG11-100 100 ft of RG-11 cable</p>
--	---

	<p>SC-MOUNT-JBAR Adjustable 20-inch mounting pole for outdoor antenna</p>
--	--

* Note: Longer cable is helpful only if it allows the outside antenna to be placed where a stronger signal is measured.

WARNING: Any product modifications that use unauthorized antennas, cables, and/or coupling devices are prohibited by the FCC. Contact FCC for details: 1-888-CALL-FCC. Changes or modifications not expressly approved by SureCall could void the user's authority to operate the equipment.

WARNING: Do not collocate antennas or operate the outdoor antenna with any other antenna or signal booster.

BEFORE INSTALLATION

IMPORTANT. BEFORE YOU BEGIN.

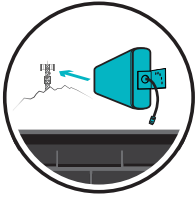

IDENTIFY THE AREA OF STRONGEST OUTSIDE SIGNAL.

Since booster performance is largely determined by the signal strength received by your outside antenna, it is important to identify the location of best signal for placement of your antenna.

The best location is generally found on the side of your home that faces your nearest cell tower and as high as possible -- where the antenna can 'see' your cell tower. Better signal received by your outside antenna means better booster performance inside. Conversely, the weaker your outside signal, the more limited your coverage will be indoors.

If you're unsure of the direction of your carrier's closest cell tower, see page 8 for suggestions.



DO NOT RELY ON CELL PHONE BARS AS AN ACCURATE MEASURING TOOL

Cell phone bars are an approximation of your signal that varies by phone and carrier. Placing your phone in test mode or downloading an app that shows your signal in decibels (dB) is more accurate. For help using this feature on your device, see "Taking signal measurements with your phone" on page 7.

During planning, installation and testing, take multiple readings several minutes apart. Also, verify that you can place and hold a call.



BETTER ANTENNA SEPARATION MEANS BETTER PERFORMANCE

Maintain a distance of at least 25 vertical feet or up to 50 feet of horizontal distance, especially if sufficient vertical separation cannot be achieved. Also, make certain the antennas are aimed away from one another.

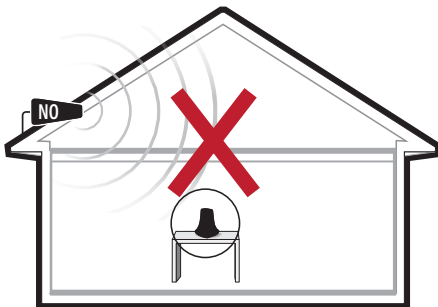

Antenna Placement

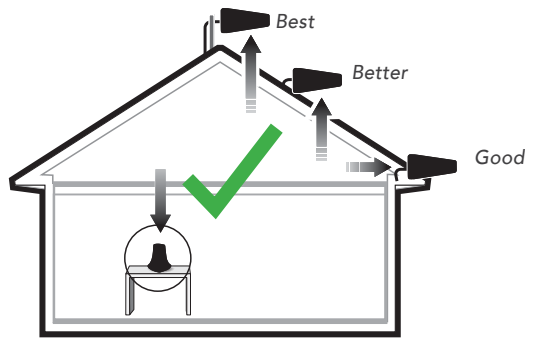

Antenna Aiming

Taking signal measurements with your phone

Cell phone bars are an approximation of your signal that varies by phone and carrier. Viewing measurements in decibel[1] milliwatts provides a more accurate reading. In most cases the units are reported in RSRP (LTE & 5G signals) and will generally fall between -80 dBm (strong) and -130 dBm (very weak). If you are connected over 3G or HSPA the decibels units are reported in RSSI and the units will generally fall between -50 dBm (strong) and -100 dBm (very weak).

PLEASE NOTE, To achieve optimal performance for your booster, it is vital to take care choosing antenna placement and antenna alignment. The coverage area that the booster provides is directly related to the strength of incoming signal received by the outdoor antenna. Mounting the outside antenna where the signal is the strongest provides the best results. If signal is extremely weak where the outside antenna is installed, indoor coverage will be limited.

See the instructions to measure decibels on your phone.

Measuring signal will be helpful to (1) identify the location outside with the strongest signal for placement of your outside antenna and (2) to measure indoor signal strength during installation and testing of your system.

During installation and testing, always take multiple readings several minutes apart. Also, take note of the band number related to each reading for accurate comparisons.

NOTE, signal measurements are displayed alongside their measurement scale. RSRP is one scale commonly used, as is RSSI. For more information, see "Signal measurement scales" on page 8.

FOR IPHONE dBm signal measurements, use the methods below.

1. First turn off your Wi-Fi
2. Dial *3001#12345#* then press the call button.
3. The field test screen will appear. Once open, the menu navigation varies depending on the iOS version.
4. Navigate to "Cell Info" in the menu
5. The measurement that reads "RSRP" is your cellular signal strength in decibel-milliwatts.
6. Note Band number

If you're using an earlier version of iOS or looking for more detailed information, we have more instructions available here: www.surecall.com/support

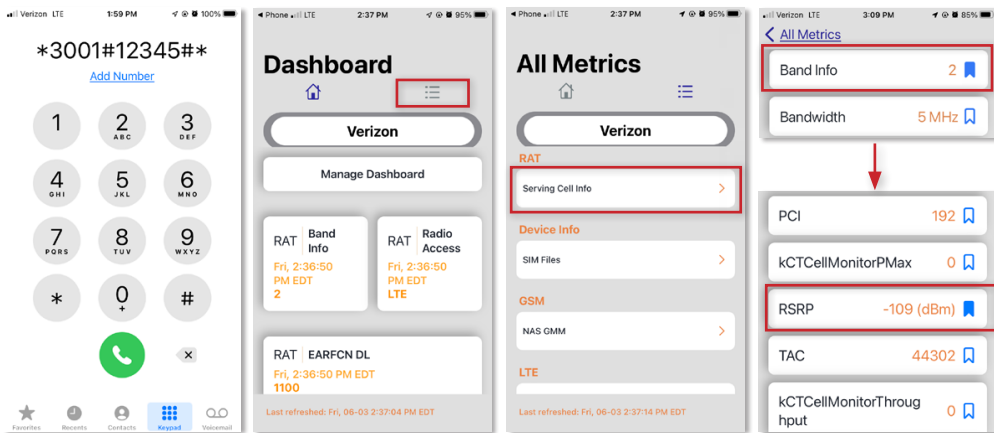

iPhone test mode

FOR ANDROID devices: Download the app “LTE Discovery” in the Google Play store.

1. Note band number
2. LTE/5G (measurement in RSSI or RSRP)

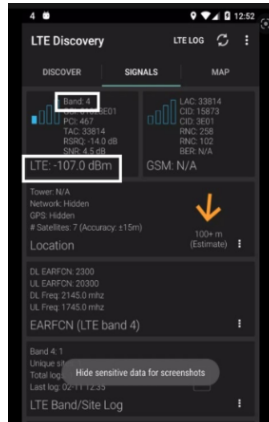

Android app “LTE Discovery”

Signal measurement scales

The relationship between RSRP and RSSI is approximate and depends on the channel bandwidth, noise floor and channel loading. The chart below displays the approximate equivalent of all four measurements:

	Signal Power (dBm)		Signal Quality (dB)	
	RSRP Phone in LTE	RSSI Phone in HSPA	RSRQ Phone in LTE	SINR Phone in HSPA
Very Edge	-125	-102	-25	3
Average	-110	-85	-20	10
Good	-95	-70	-12	15
Best	-80	-55	-8	20

Finding your closest cell tower

Since performance is largely determined by the signal received by the outdoor antenna, it is important to know the direction in which you will aim your directional outside antenna before installation.

The best location for your outside antenna is generally found on the side facing your nearest cell tower and as high as possible -- where the antenna can 'see' your cell tower.

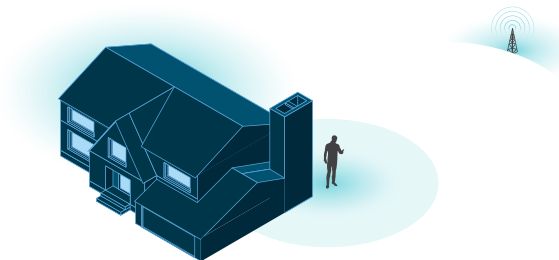

Finding your strongest outside signal

If you're not sure of the location of your nearest cell tower, there are resources available. You may utilize crowd-sourced cell tower resources such as sites like www.cellmapper.net.

See below for brief instructions on utilizing cellmapper.net

Visit website www.cellmapper.net

1. Find your location on the map
2. Select your provider

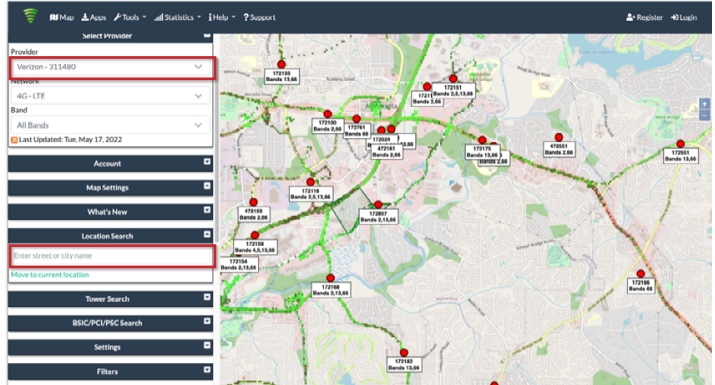

3. Find your cell tower by clicking on the red or green dots on the map closest to your home.

Once selected, detailed information of each base station is shown to the left, including the communication standards and frequency band and block.

The shaded area represents the coverage area for that base station.

4. Locate the closest base station with signal coverage facing the direction of your home and note the direction in relation to your home.

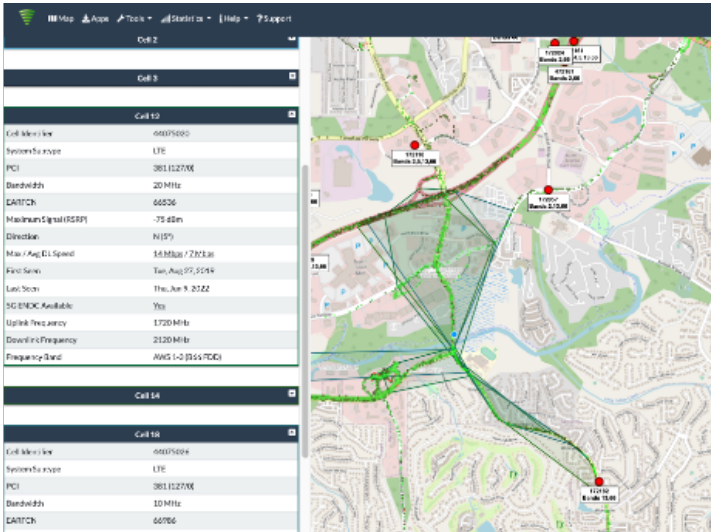

Note: While your home may or may not be located inside a shaded coverage zone indicated on the map.

Tools needed

- Ladder
- Drill
- ~2.5" diameter pole for mounting outside antenna (if needed, SC-MOUNT-JBAR can be purchased separately)
- Recommended: Surge protected power strip and cable clips.

Grounding the outside antenna

SureCall recommends all outside antennas be properly grounded. See "Optional accessories" on page 5.

Power requirements

Use only the provided power supply with this product (SC-AC-5V-3A-B). DO NOT use the booster with a higher or lower voltage power supply. This can damage the booster, cause personal injury, and void your warranty.

Use of a power strip with surge protection is strongly recommended.

Cable guidelines

The provided cable is 50 ft of RG-11 (part SC-RG11-50). If longer cable is needed – 100 ft of RG-11 (part SC-RG11-100) is available. A longer cable is helpful only if it allows you to place the outside antenna in a location where you measure stronger signal.

Routing cable

SureCall recommends that cable connected to the outside antenna run straight down and away from the outside antenna, not wrapped or draped near it. When securing the cable, be sure to remove any kinks or loops.

Route cable along and through a wall that leads closest to the location of the booster.

SureCall recommends that cable entering the home from an exterior wall use appropriately rated sealant/caulking at the point of entry.

Following completion of install, weatherproof the exterior coax connections with sealing tape.

INSTALLATION

Before installation, review all the information in this manual.

Installation Overview

Step 1. Find the outside area with the strongest signal.

Step 2. Install the outside antenna **4**, connect coax cable **3** and route the cable indoors.

Step 3. Place the Flare iQ **1** on a table or desktop, center of the area where signal is needed and connect to cable.

Step 4. Connect the Flare booster to the provided power cable **2** and plug into an AC power source.

Check system and optimize installation, if needed

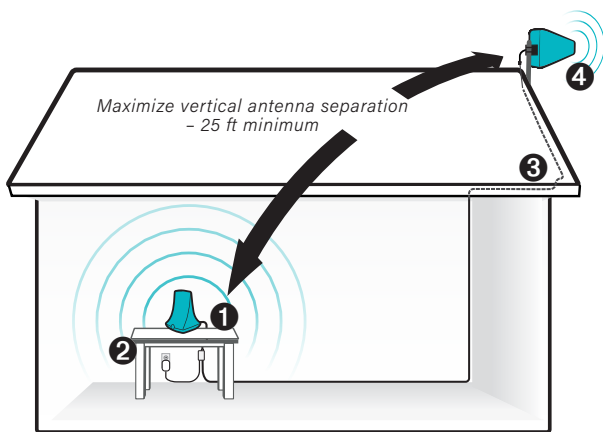

Installation overview

Perform a Soft install

PRIOR TO SECURING THE LOCATION OF ANY BOOSTER PARTS, PERFORM A SOFT INSTALLATION.

Refrain from securing your cable, drilling any holes, etc. until you complete and test the installation of the system.

Create a soft installation by placing the components in their approximate locations - with the outside antenna in the location with best signal and Flare Booster in the area signal is needed and connect the components with the provided cable. Once the main components are connected, add power.

Once the components are in their approximate locations, you may begin using your app to optimize their location and make adjustments to maximize your system performance.

NOTE: Do not apply power until the system is fully connected.

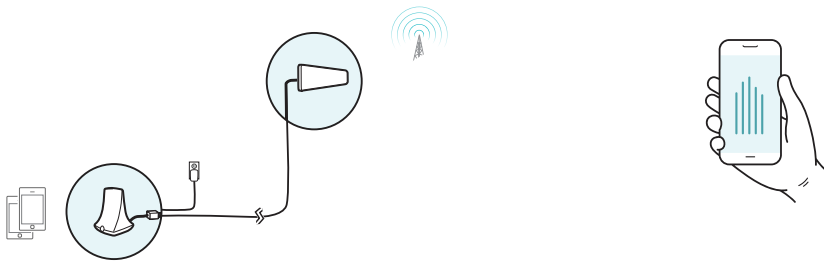

Step 1: Find area outside with strongest signal

Identify the outside location with the strongest signal for placement of your outdoor antenna. Maximum performance is achieved when the antenna is aimed toward the strongest signal source. If you know the direction of your provider's tower, point the antenna in that direction. If you are unsure of the location, see "Finding your closest cell tower" on page 8.

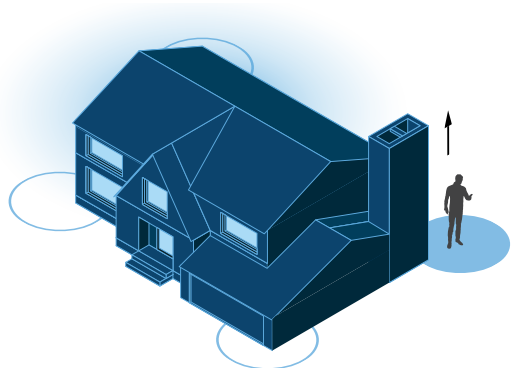

Finding your strongest outside signal

Step 2: Install the outside antenna

Once you have identified the area of strongest signal, choose where you will mount your outside antenna while considering the following antenna placement guidelines.

- Mount at the highest possible location above the roofline – The mounting area must have at least a 3 ft radius clear of obstructions, other radiating elements and metal objects such as pipes or metal siding.
- Maximize antenna separation. Plan at least 25 vertical feet (or at least 50 horizontal feet) of separation between the outside antenna the booster.
- Note that the outside antenna can be mounted to an exterior surface or a 1-2 inch diameter pole. A mounting pole is available separately (SC-MOUNT-JBAR) or PVC piping from your local hardware can also be used.
- Avoid placement near windows, where possible, as it increases the potential for oscillation.
- Ensure the outside antenna is oriented to face away from the booster.
- Mount the outside antenna at the corner or side of the roof which faces your cell tower.
- Avoid aiming the antenna towards reflective materials (such as windows) where the signal may be reflected towards your home.

Maximize antenna isolation

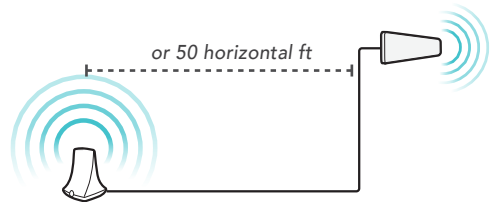
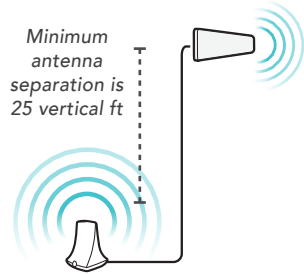

USE THE APP TO HELP!

Once you've read the placement guidelines, use the feedback on your app to help you identify the best location and angle for your antenna

Yagi antenna installation

Once you have identified your install location, assemble the u-bolt, L-bracket, nuts and washers onto a pole (available separately) as shown in the illustration. Orient the antenna with the drip hole at the bottom.

Do not fix mounting hardware until the optimum antenna angle is found. Loosely secure the antenna in a manner that allows for rotation during final system testing.

Once the outside antenna is secured to a pipe or pole, connect antenna to one end of the provided RG-11 cable and tighten the connection. Run the cable along route to planned location of your booster.

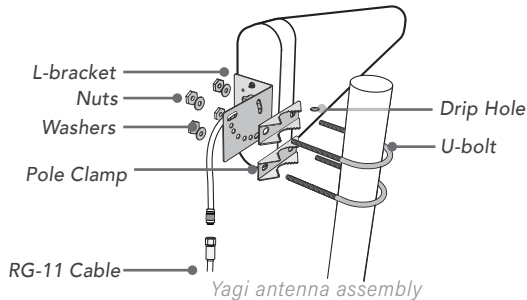

Step 3. Place the Booster

Place the booster in a central location where signal is needed and at least 25 ft. from the outdoor antenna location. When placing the booster, note that further separation between the booster and outside antenna will increase booster performance. Connect the open end of the RG-11 cable from the outside antenna to the booster and tighten connection.

Please note that the performance and range of your booster depends on three factors:

1. Signal strength at the location of the outside antenna.
2. Interior building materials between the booster and your mobile device.
3. Distance between the outside antenna and booster (while at least 25 ft. separation is recommended, further separation will increase performance).

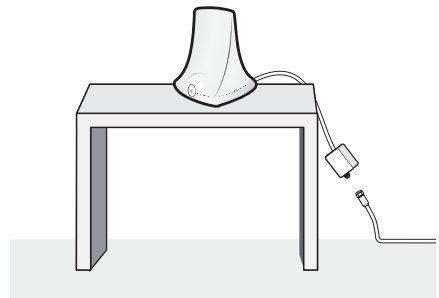

Placing Booster and connecting cable



USE THE APP TO HELP!

Once you've read the placement guidelines, use the feedback on your app to help you identify the best location for your booster

Cable

Locate and connect the open end of the 50 ft cable from the outside antenna to the booster port.

See "Cable guidelines" on page 10 for more information.

Step 4: Connect to Power

Once the booster and outside antenna are connected and in place, connect the power cord to the signal booster and plug into a power outlet.

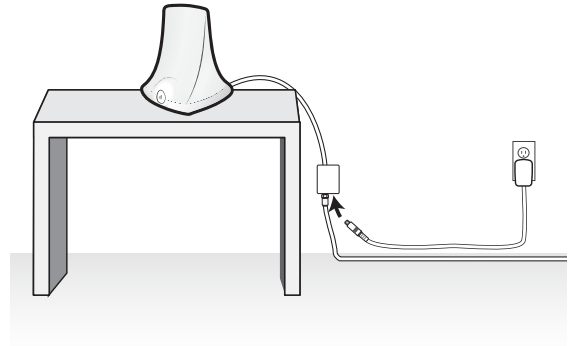

Connecting the Power Supply

Check and optimize system, if needed

When your system is in place and fully connected, test system performance in locations you have previously experienced poor signal. Verify that you have a reliable connection by taking multiple readings several minutes apart. For instructions on taking measurements with your cell phone, see page 7. Also, verify that you can place and hold a call.

If the signal strength has improved, your booster is working.

App measurements

Note: It is helpful to know the the frequency bands used by your carrier. If the app indicates poor performance on a frequency not used by your carrier and you are receiving improved signal, no adjustments are needed.

If signal has not improved, most issues can be resolved by addressing antenna separation. See page 16 for suggestions regarding antenna isolation. Power cycling the booster after each adjustment may be necessary.

Keep in mind, identifying the setup that yields the best possible results for your environment will come from testing -- balancing the elimination of interference and while also receiving the best possible signal.

WARNING: This booster should not be used near open fire or flame. Storage and transportation: Store and place in non-extreme room-temperature and dry environment.

WARNING: This booster is rated for 5-15V input voltage. DO NOT use the booster with a higher voltage power supply. This can damage the booster, cause personal injury, and void your warranty.

SYSTEM OPTIMIZATION

Antenna optimization

The Flare iQ automatically reduces gain (coverage performance) because of insufficient RF separation between the inside and outside antennas. Consider the options listed in this section to resolve issues with inadequate antenna isolation.

Note, in smaller wood constructed homes some reduction in gain is considered 'normal' operation.

- Try increasing the antenna isolation by increasing the vertical distance between the outside antenna and the flare amplifier. Verify that the separation distance is at least 25 feet vertically. A minimum of 50 feet of horizontal separation may be required, especially if vertical separation is not possible.
- Make sure the outside antenna is pointing away from the Flare amplifier.
- Check that there are no sources of interference such as cellular modems or access points. It may be necessary to increase the separation distance with the flare amplifier.
- Verify neither component is placed near a window.
- Mount the outside antenna as high as possible and at the corner or side of the roof which faces your cell tower.
- Avoid placing / aiming the antenna towards materials (such as windows) where the signal may be reflected towards your home or office.

Keep in mind, identifying the setup that yields the best possible results for your environment will come from testing -- balancing the elimination of interference and while also receiving the best possible signal.

Antenna testing

As a final step, identify the precise antenna angle which provides the maximum possible performance. For this step, it's best to have another person inside to report results. Record your results below.

Rotate the outside antenna around the mast beginning with wide angle measurements then in progressively smaller increments until the peak angle is found. After each turn, power cycle the booster then note the signal reading from the inside antenna's projected area.

Once you've identified the optimum angle, secure the outside antenna in place.

LOCATION	BEFORE	Band #	AFTER, Test 1	Band #	Test 2	Band #	Test 3	Band #

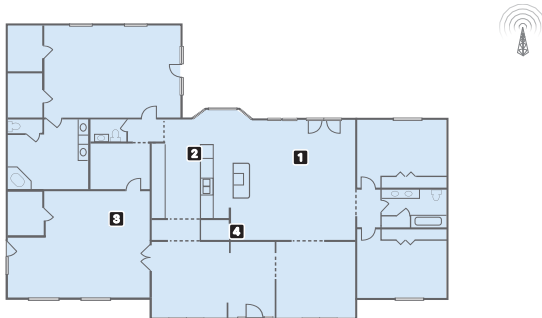

Example testing plan

TROUBLESHOOTING

If you have any questions during setup, please reach out to our US-based experienced support technicians:

Call: 1-888-365-6283, Email: support@surecall.com, or Visit: www.surecall.com/support

Problem	Resolution
Signal booster has no power	<p>Connect the power supply to an alternate power source.</p> <p>Be sure the power source is not controlled by a switch that can remove power from the outlet.</p> <p>Check the POWER LED (⏻) on the signal booster. If it is OFF, contact tech support at: 1-888-365-6283 or support@surecall.com, or go to www.surecall.com/support</p>
After installing your signal booster system, you have no signal or reception	<p>Verify that cable connections are tightly fitted to the booster and antenna.</p> <p>Try further separating the booster and antenna.</p> <p>Verify that there is usable signal where the antenna is placed.</p> <p>Remember: Bars are not always a reliable measure of signal. The best way to confirm signal coverage is the ability to place and hold a call.</p>

SPECIFICATIONS

	Flare 3.0 (U.S.) ; Flare 3.0 CA (Canada)
Uplink Frequency Range (MHz):	698–716 / 776–787 / 824–849 / 1850–1915 / 1710–1755
Downlink Frequency Range (MHz):	728–746 / 746–757 / 869–894 / 1930–1995 / 2110–2155
Donor/Server Port Impedance:	75 ohm / 50 ohm
Maximum Gain:	72 dB
Noise Figure:	7 dB
VSWR:	≤2.0
Supported Standards:	4G / LTE / 5G cellular standards
AC Input:	Input: AC 110 – 240 V, 60 Hz ; Output: DC 5V / 3A
Maximum Output Power:	1 Watt EIRP
Cable:	RG-11 (50 ft.)
RF Connectors:	Donor port: F Female, Server port: Integral
Power Consumption:	<12W
Weight:	1.8125 lb.
Dimensions:	5.125 × 7.25 × 5.625 inches
Certifications:	Certifications (US): FCC ID: RSNFLARE-3 (Flare 3.0); BLE Module FCC ID: XPYNINAB1, Certifications (Canada): IC : 7784A-FLARE3 (Flare 3.0 CA); BLE Module IC : 8595A-NINABA1

Note: The term "IC" before the radio certification number only signifies that Industry Canada technical specifications were met.

Frequency (MHz)	PreAGC			PreAGC		
	Pulse GSM			4.1 MHz AWGN		
	Input (dBm)	Output (dBm)	Gain (dB)	Input (dBm)	Output (dBm)	Gain (dB)
Uplink: 1710-1755	-49.5	20.0	69.5	-49.0	19.4	68.4
Uplink: 1850-1915	-49.5	22.1	71.6	-45.8	21.6	67.4
Uplink: 824-849	-39.3	25.3	64.5	-36.6	26.0	62.6
Uplink: 698-716	-36.8	25.0	61.8	-37.1	25.2	62.3
Uplink: 777-787	-38.6	22.1	60.7	-38.4	20.5	58.9
Downlink: 2110-2155	-55.2	12.5	67.7	-57.0	10.4	67.4
Downlink: 1930-1995	-57.2	11.2	68.4	-60.4	8.2	68.6
Downlink: 869-894	-51.2	11.8	63.0	-50.8	10.9	61.7
Downlink: 728-746	-47.5	14.5	62.0	-50.7	10.7	61.4
Downlink: 746-757	-45.8	11.8	57.6	-49.4	8.5	57.9

Kitting Information

Component	Product number	Gain/Loss					Note
		LTE-A 707 MHz	LTE-V 731 MHz	Cellular 800 MHz	PCS 1900 MHz	AWS 1700 / 2100 MHz	
Outdoor Antenna*	SC-289W	3 dBi	3 dBi	3 dBi	4 dBi	4 dBi / 4 dBi	
	SC-231W	8 dBi	8 dBi	8 dBi	10 dBi	10 dBi / 10 dBi	
Outdoor Cable*	SC-RG6-50	3.32 dB	3.32 dB	3.95 dB	6.42 dB	6.22 dB / 6.68 dB	50 Feet or longer
	SC-RG11-50	2.29 dB	2.29 dB	2.53 dB	3.73 dB	3.68 dB / 4.51 dB	50 feet or longer
Indoor Antenna	SC-322W	2.5 dBi	2.5 dBi	3 dBi	5 dBi	4 dBi / 5 dBi	

*Note: The Flare 3.0 booster is suitable for use with all equivalent and lower gain antennas, as well as, equivalent or greater lengths of cable.

CONSUMER GUIDELINES

THIS IS A CONSUMER DEVICE

BEFORE USE, you **MUST REGISTER THIS DEVICE** with your wireless provider and have your provider's consent. Most wireless providers consent to the use of signal boosters. Some providers may not consent to the use of this device on their network. If you are unsure, contact your provider.

In Canada, **BEFORE USE** you must meet all requirements set out in ISED [CPC-2-1-05](#)¹

You **MUST** operate this device with approved antennas and cables as specified by the manufacturer. Antennas **MUST** be installed at least 20 cm (8 inches) from (i.e. **MUST NOT** be installed within 20 cm of) any person.

You **MUST** cease operation of this device immediately if requested by the FCC (or ISED in Canada) or a licensed wireless service provider.

WARNING: E911 location information may not be provided or may be inaccurate for calls served by using this device.

This device may operate in a fixed location only, for in-building use.

Register your cellular booster with your wireless carrier at the following urls:

Verizon: <http://www.verizonwireless.com/wcms/consumer/register-signal-booster.html>

AT&T: <https://securec45.securewebsession.com/attsignalbooster.com/>

T-Mobile: <https://support.t-mobile.com/docs/DOC-9827>

Sprint: https://www.sprint.com/legal/fcc_boosters.html

U.S. Cellular: <http://www.uscellular.com/uscellular/support/fcc-booster-registration.jsp>

CAN ICES-3 (B)/NMB-3(B) (Canada) :

This Class B digital apparatus meets all requirements of the Canadian Interference Causing Equipment Regulations. Operation is subject to the following two conditions: (1) this device may not cause harmful interference, and (2) this device must accept any interference received, including interference that may cause undesired operation.

The Manufacturer's rated output power of this equipment is for single carrier operation. For situations when multiple carrier signals are present, the rating would have to be reduced by 3.5 dB, especially where the output signal is re-radiated and can cause interference to adjacent band users. This power reduction is to be by means of input power or gain reduction and not by an attenuator at the output of the device.

This equipment has been tested and found to comply with the limits for a Class B digital device, pursuant to part 15 of the FCC Rules. These limits are designed to provide reasonable protection against harmful interference in a residential installation. This equipment generates, uses and can radiate radio frequency energy and, if not installed and used in accordance with the instructions, may cause harmful interference to radio communications. However, there is no guarantee that interference will not occur in a particular installation. If this equipment does cause harmful interference to radio or television reception, which can be determined by turning the equipment off and on, the user is encouraged to try to correct the interference by one or more of the following measures:

- Reorient or relocate the receiving antenna.
- Increase the separation between the equipment and receiver.
- Connect the equipment into an outlet on a circuit different from that to which the receiver is connected.
- Consult the dealer or an experienced radio/TV technician for help.

Caution: Any changes or modifications not expressly approved by the party responsible for compliance could void the user's authority to operate this equipment.

1 For details on the requirements specified in ISED CPC-2-1-05, visit: <http://www.ic.gc.ca/eic/site/smt-gst.nsf/eng/sf08942.html>

WARRANTY

Three-year product warranty

To activate your three-year manufacturer's warranty, register at www.SureCall.com/activate

SureCall warrants its products for three years from the date of purchase against defects in workmanship and/or materials. Specifications are subject to change. The three-year warranty only applies to products meeting the latest FCC Certification Guidelines stated on 2/20/2013 and going into effect April 30, 2014. A two-year warranty applies to any products manufactured before May 1, 2014.

Products returned by customers must be in their original, un-modified condition, shipped in the original or protective packaging with proof-of-purchase documentation enclosed, and a Return Merchandise Authorization (RMA) number printed clearly on the outside of the shipping container.

Buyers may obtain an RMA number for warranty returns by calling the SureCall Return Department toll-free at 1-888-365-6283. Any returns received by SureCall without an RMA number clearly printed on the outside of the shipping container will be returned to sender. In order to receive full credit for signal boosters, all accessories originally included in the signal booster box must be returned with the signal booster. (The Buyer does not need to include accessories sold in addition to the signal booster, such as antennas or cables.)

This warranty does not apply to any product determined by SureCall to have been subjected to misuse, abuse, neglect, or mishandling that alters or damages the product's physical or electronic properties.

SureCall warrants to the Buyer that each of its products, when shipped, will be free from defects in material and workmanship, and will perform in full accordance with applicable specifications. The limit of liability under this warranty is, at SureCall's option, to repair or replace any product or part thereof which was purchased up to THREE YEARS after May 1, 2014 or TWO YEARS for products purchased before May 1, 2014, as determined by examination by SureCall, prove defective in material and/or workmanship. Warranty returns must first be authorized in writing by SureCall. Disassembly of any SureCall product by anyone other than an authorized representative of SureCall voids this warranty in its entirety. SureCall reserves the right to make changes in any of its products without incurring any obligation to make the same changes on previously delivered products.

As a condition to the warranties provided for herein, the Buyer will prepay the shipping charges for all products returned to SureCall for repair, and SureCall will pay the return shipping with the exception of products returned from outside the United States, in which case the Buyer will pay the shipping charges.

The Buyer will pay the cost of inspecting and testing any goods returned under the warranty or otherwise, which are found to meet the applicable specifications or which are not defective or not covered by this warranty.

Products sold by SureCall shall not be considered defective or non-conforming to the Buyer's order if they satisfactorily fulfill the performance requirements that were published in the product specification literature, or in accordance with samples provided by SureCall. This warranty shall not apply to any products or parts thereof which have been subject to accident, negligence, alteration, abuse, or misuse. SureCall makes no warranty whatsoever in respect to accessories or parts not supplied by it.

Limitations of Warranty, Damages and Liability:

EXCEPT AS EXPRESSLY SET FORTH HEREIN, THERE ARE NO WARRANTIES, CONDITIONS, GUARANTEES, OR REPRESENTATIONS AS TO MERCHANTABILITY, FITNESS FOR A PARTICULAR PURPOSE, OR OTHER WARRANTIES, CONDITIONS, GUARANTEES, OR REPRESENTATIONS, WHETHER EXPRESSED OR IMPLIED, IN LAW OR IN FACT, ORAL OR IN WRITING.

SURECALL AGGREGATE LIABILITY IN DAMAGES OR OTHERWISE SHALL NOT EXCEED THE PAYMENT, IF ANY, RECEIVED BY CELLPHONE-MATE, INC. FOR THE UNIT OF PRODUCT OR SERVICE FURNISHED OR TO BE FURNISHED, AS THE CASE MAY BE, WHICH IS THE SUBJECT OF CLAIM OR DISPUTE. IN NO EVENT SHALL SURECALL BE LIABLE FOR INCIDENTAL, CONSEQUENTIAL, OR SPECIAL DAMAGES, HOWSOEVER CAUSED.

All matters regarding this warranty shall be interpreted in accordance with the laws of the State of California, and any controversy that cannot be settled directly shall be settled by arbitration in California in accordance with the rules then prevailing of the American Arbitration Association, and judgment upon the award rendered may be entered in any court having jurisdiction thereof. If one or more provisions provided herein are held to be invalid or unenforceable under applicable law, then such provision shall be ineffective and excluded to the extent of such invalidity or unenforceability without affecting in any way the remaining provisions hereof.

SureCall has made a good faith effort to ensure the accuracy of the information in this document and disclaims the implied warranties of merchantability and fitness for a particular purpose and makes no express warranties, except as may be stated in its written agreement with and for its customers. SureCall shall not be held liable to anyone for any indirect, special or consequential damages due to omissions or errors. The information and specifications in this document are subject to change without notice.

© 2023. All Rights Reserved. All trademarks and registered trademarks are the property of their respective owners.

SureCall, Inc
48346 Milmont Drive
Fremont, California 94538, USA
888.365.6283 | www.surecall.com