

尺寸：210*145MM

80克书纸

黑白印刷



MODEL NO.

RPJ241-COMBO-BLACK-V

RPJ241-COMBO-AQUA-V

RPJ241-COMBO-WHITE-V

MULTIMEDIA PROJECTOR INSTRUCTION MANUAL



Ideal for dark viewing environments for optimal performance.
Please note: Projector brightness is measure in ANSI lumens. Your viewing environment is the deciding factor on how many lumens your projector needs.

PLEASE READ BEFORE OPERATING THIS EQUIPMENT

This product has been manufactured and sold under the responsibility of Curtis International Ltd. RCA, the RCA logo, the two dogs (Nipper and Chipper) logo, are registered trademarks or trademarks of Technicolor (S.A.) or its affiliates and are used under license by Curtis International Ltd. Any other product, service, company, trade or product name and logo referenced herein are neither endorsed nor sponsored by Technicolor (S.A.) or its Affiliates.

Important Safety Instructions

1. Read these Instructions.
2. Keep these Instructions.
3. Heed all Warnings.
4. Follow all instructions.
5. Do not use this apparatus near water.
6. Clean only with a dry cloth.
7. Do not block any ventilation openings. Install in accordance with the manufacturer's instructions.
8. Do not install near any heat sources such as radiators, heat registers, stoves, or other apparatus (including amplifier) that product heat.
9. Protect the power cord from being walked on or pinched particularly at plugs, convenience receptacles, and the point where they exit from the apparatus.
10. Only use attachments/accessories specified by the manufacturer.
11. Unplug this apparatus during lightning storms or when unused for long periods of time.
12. Refer all servicing to qualified service personnel. Servicing is required when the apparatus has been damaged in any way, such as power-supply cord or plug is damaged, liquid has been spilled or objects have fallen into the apparatus, the apparatus has been exposed to rain or moisture, does not operate normally, or has been dropped.
13. Use only with a cart, stand, tripod, bracket, or table specified by the manufacturer or sold with the apparatus. When a cart is used, use caution when moving the cart/ apparatus combination to avoid injury from tip-over.



Additional Warnings and Precautions

1. Do not look directly into the projector light.
2. **Don't touch the project lens**
3. Mains adapter is used as disconnect device and it should remain readily operable during intended use. In order to disconnect the apparatus from the mains completely, the mains plug should be disconnected from the mains socket outlet completely.
4. **CAUTION:** Use of controls or adjustments or performance of procedures other than those specified may result in hazardous radiation exposure.
5. **WARNING:** Changes or modified to this unit not expressly approved by the party responsible for compliance could void the user's authority to operate the equipment.
6. **WARNING:** Use of this unit near fluorescent lighting may cause interference regarding use of the remote. If the unit is displaying erratic behavior move away from any fluorescent lighting, as it may be the cause.
7. **WARNING:** Shock hazard - Do Not Open.
8. Caution and marking information is located at the rear or bottom of the apparatus.
9. **WARNING:** To reduce the risk of fire or electric shock, do not expose this apparatus to rain, moisture, dripping, or splashing.
10. Objects filled with liquids, such as vases, shall not be placed on the apparatus.

FCC Warning

FCC ID: LCS180515064AE

This device complies with Part 15 of the FCC rules. Operation is subject to the following two conditions: (1) this device may not cause harmful interference, and (2) this device must accept any interference received, including interference that may cause undesired operation.

NOTE: This equipment has been tested and found to comply with the limits for a Class B digital device, pursuant to Part 15 of the FCC Rules. These limits are designed to provide reasonable protection against harmful interference in a residential installation. This equipment generates, uses, and can radiate radio frequency energy and, if not installed and used in accordance with the instructions, may cause harmful interference to radio communications. However, there is no guarantee that interference will not occur in a particular installation. If this equipment does cause harmful interference to radio or television reception, which can be determined by turning the equipment off and on, the user is encouraged to try to correct the interference by one or more of the following measures:

- Reorient or relocate the receiving antenna.
- Increase the separation between the equipment and receiver.
- Connect the equipment into an outlet on a circuit different from that to which the receiver is connected.
- Consult the dealer or an experienced radio/TV technician for help.

In The Box

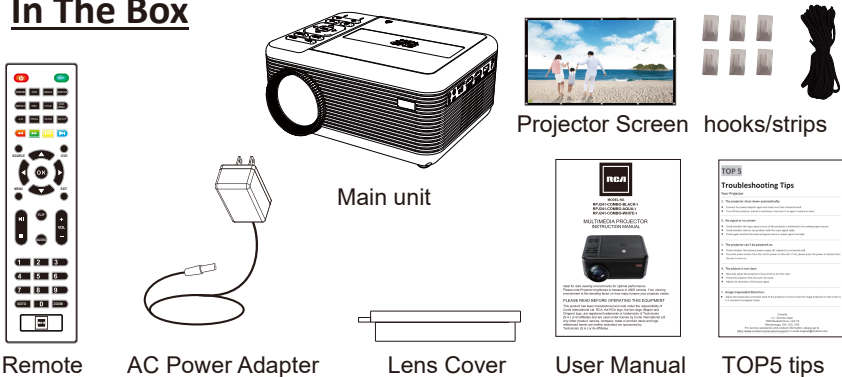
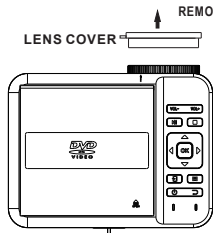

Table of Contents

Important Safety Instructions	P1
Additional Warnings and Precautions	P2
FCC Warning	P3
In The Box	P3
Table of Contents	P4
Remove & Close the Lens Cover	P5
Placing Your Projector	P5
To Reduce Image Distortion	P6
Distance Between The Projector And Screen	P6
Placing Your Projector On Ceiling	P6
Adjust the Vertical Location	P7
Adjust the Focus and Keystone	P7
Controls of Remote	P8
Install / Remove Battery Of Remote	P8
Controls of Projector	P9
Install Power Adapter	P10
Main Operation	P10
Connect HDMI show the Image On Projector Screen	P11
Connect AV Show The Image On Projector Screen	P11
Connect VGA Show The Image On Projector Screen	P12
Connect Audio Output (Aux Out / Line Out / Earphones)	P13
Install USB Device And Micro Sd Card “TF”	P13
Using TF Card and USB Playback	P14
Using DVD Playback	P15
Using Bluetooth Playback	P15
Using Projector Menu 1.0	P16
Using Projector Menu 2.0	P17
Using Projector Menu 3.0	P18
Using Projector Menu 4.0	P19
Specifications	P20
Projector screen Setup	P23
Trouble shooting	P24
Warranty Card	P25

Remove & Close The Lens Cover

Remove the lens cover before using



Close the lens cover when unit not using

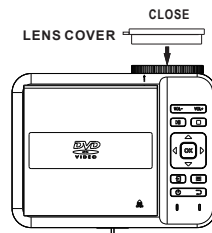

Placing Your Projector

Your projector can be installed in four different configurations (see picture below):

Front Table:

Select this location with the projector placed near the floor in front of the screen. This is the most common way to position the projector for quick setup and portability.

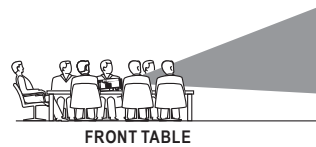

Front Ceiling:

Select this location with the projector suspended upside-down from the ceiling in front of the screen.

NOTE: A projector mount is required to install the projector in a ceiling.

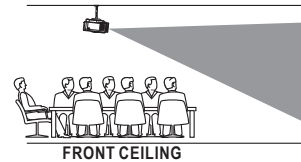

Rear Table:

Select this location with the projector placed near the floor behind the screen.

NOTE: That a special rear projection screen is required.

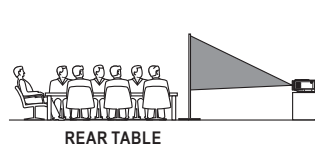

Rear Ceiling:

Select this location with the projector suspended upside-down from the ceiling behind the screen.

NOTE:

A projector mount is required to install the projector in a ceiling.

A special rear projection screen is required.

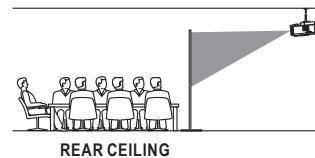

To Reduce Image Distortion

Square /Rectangle

It is recommended to move the projector as close to center of screen.

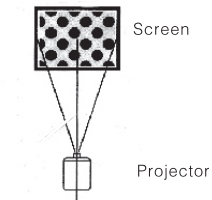

Distance Between The Projector And Screen

Measure the distance between the projector and where you want to position the screen. This is the projection distance.

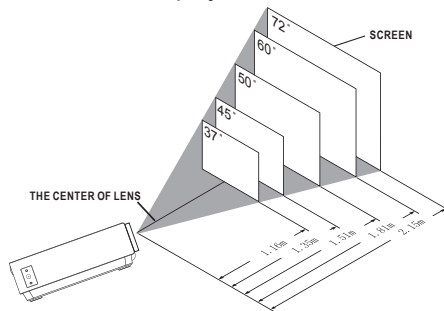

Placing Your Projector On Ceiling

When installing the projector in the ceiling, please purchase a projector mount recommended by an installation professional and follow the instructions that come with the mount.

Before installing the projector in the ceiling, please check to make sure the ceiling structure can support the weight of the projector and the mount. If in doubt, please ask the advice from an installation professional.

NOTE: Projector mount and screw(s) not included

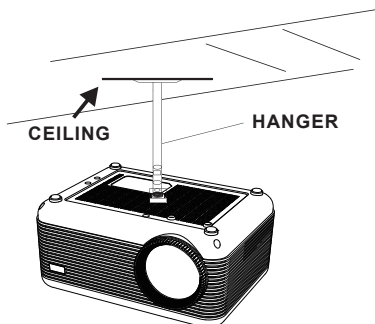

FIXED HANGER HOLE

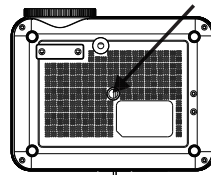

Adjust The Vertical Location

Follow below picture to adjust the vertical location.

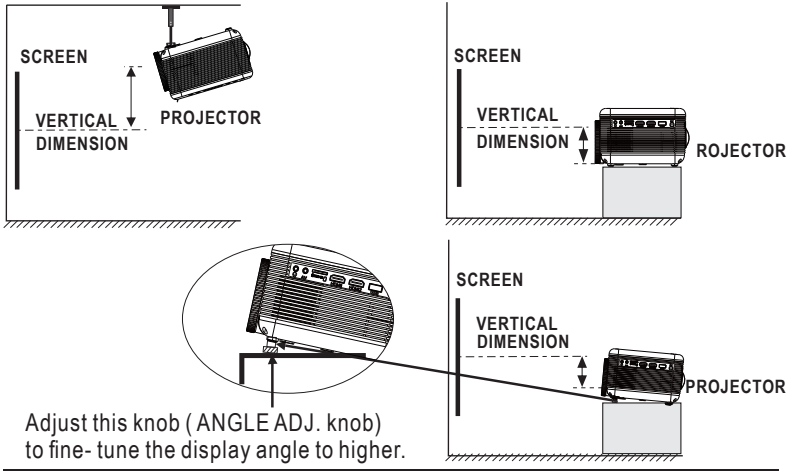

Adjust The Focus And Keystone

Follow below picture to adjust the focus and trapezoidal screen.

Adjust the focus by turning the knob while observing the image pixels near the center of the screen. Optimal focus is obtained when the pixels are clearly visible. Depending on the projected screen size, the focus near the screen edges may be less sharp than the screen center.

FOCUS ADJ. KNOB

Then sharpen the image by rotating focus knob.

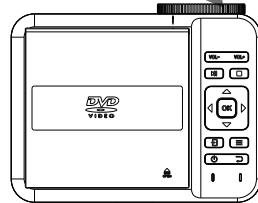

Keystone image is created when the projector beam is projected to the screen in an angle. Keystone correction will restore the distorted image to a rectangular or square shape.

TRAPEZOIDAL ADJ. KNOB

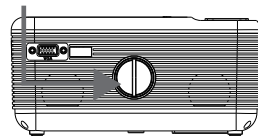

Controls Of Remote

POWER

Press to power ON.

Mute

Mute the audio of the player. Press it again to activate the sound.

RANDOM

Press to random playing for the loaded disc.

OSD

Press to display the information of the current video/ audio.

Angle

On supported DVDs, press and hold to view alternate angles.

Subtitle

Short press to change subtitle mode.

Repeat

Press here repeatedly to cycle through repeat options for the loaded disc. .

PBC

Press to activate Play Back Control function only for a VCD disc. Press it again to be off.

Title

Press to view the title menu on a loaded DVD.

DVD Menu

Press to view the main menu on a loaded DVD.

A-B

Press to create a repeating loop on a loaded DVD.

PROG

Program a loaded disc to play chapters and titles or tracks in a specified order.

SLOW

During playback, press the SLOW button repeatedly to set the slow motion speed. Press OK button to resume.

SETUP

Press to access the setup menu only for DVD mode.

Previous/Next

Press to skip between chapters or tracks.

Rewind/ Fwd

Press to search through an individual chapter or track.

Arrows (UP/DOWN/LEFT/RIGHT)/ OK

Press to navigate and confirm selections in settings and other menus.

SOURCE

Press to select media source (AV/HDMI 1/ HDMI 2/VGA/ DVD/MEDIA PLAYER).

DVD

Note :during in DVD mode, press DVD button on remote once to turn into USB , and press DVD button twice for software upgradation when it's detected this software is plugged in the USB mode.

MENU

Press to access projector settings menu.

EXIT

Press to exit the projector menu or the audio/movie playback.

Play/Pause

Press here to play or pause the audio / movie playback.

STOP

Stop the audio/video /photo playback.

FLIP

Press to rotate/ mirror projector screen.

Audio

Press here to switch the available audio channels provided by the disc.

VOL +

VOL-

Adjust the volume up. Adjust the volume down.

0-9 Number Keypad

Enter chapter/title to play.

Go To

Go to a specific chapter or track numbers. Use play button to begin playing.

Zoom

For the movie/video, press to access the zoom function, you can select the 2x, 3x, 4x, 1/2, 1/3, 1/4.

For the photo ,press it to switch between the zoom 100%, 125%, 150%, 200%, 75%, 50% and normal status



Install / Remove Battery Of Remote

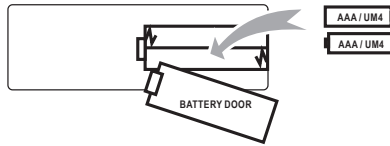

Remove the battery compartment cover on the back of your remote by carefully sliding to open. The battery cover can then be lifted away. Fit the correct batteries (not included), referring to the polarity markings. Finally, replace the cover.

NOTES:

- Batteries shall not be exposed to excessive heat such as sunshine, fire
- Be sure that the batteries are installed polarity correctly.
- Do not mix old and new batteries.
- Only same or equivalent type batteries as recommend are to be used.
- Do not dispose of batteries in fire, battery may explode or leak. Do not try to recharge a battery

Controls Of Projector

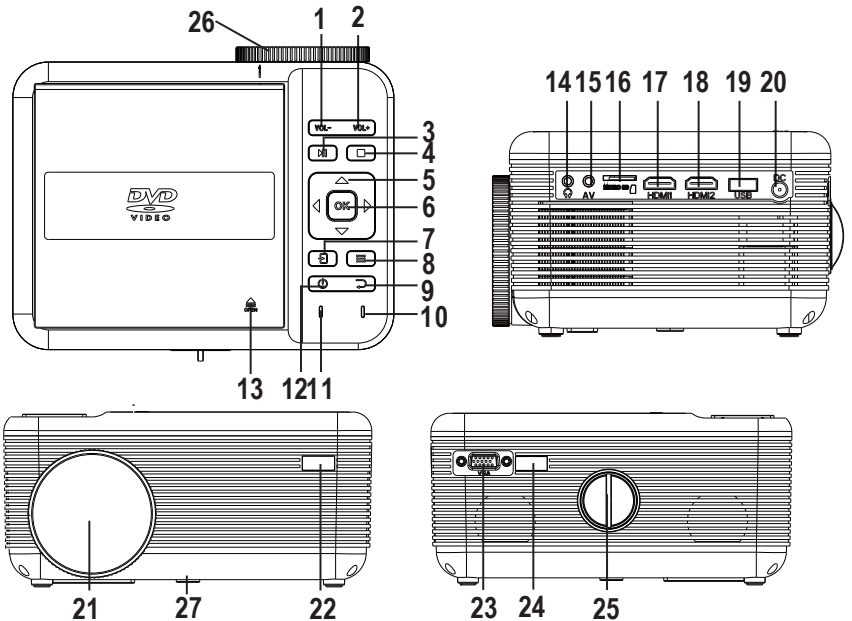

- | | | |
|---------------------|-------------------------|---------------------------|
| 1. VOLUME - | 10. Power on Indicator | 19.USB Port(Media Player) |
| 2.VOLUME + | 11. Power off Indicator | 20. DC IN jack |
| 3.PLAY/PAUSE | 12 POWER button | 21. LENS |
| 4. STOP | 13 Open disc cover | 22.IR Window (Front Side) |
| 5.NAVIGATOR Buttons | 14. EARPHONE jack | 23.VGA Port |
| 6. OK | 15. AV jack | 24. IR Window (Rear Side) |
| 7. SOURCE button | 16. Micro SD card. | 25. TRAPEZOIDAL ADJ. Knob |
| 8. MENU button | 17. HDMI Port 1 | |
| 9.RETURN button | 18. HDMI Port 2 | |

Install Power Adapter

Follow below picture to connect power adapter

Connect small end of adapter **FIRST**. Plug the adapter body to power outlet.

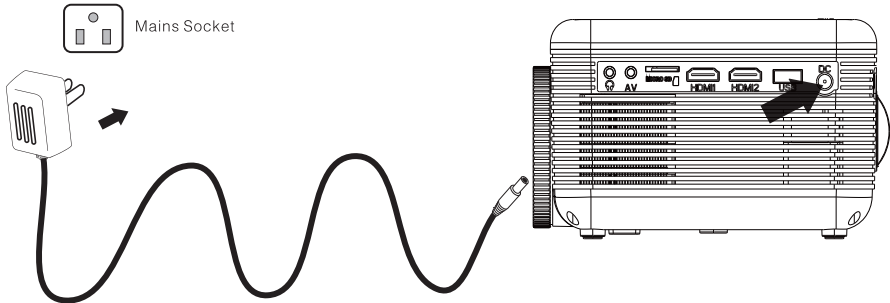

Main Operation

 - Press the button to turn on unit, press again to turn off.

 / **SOURCE** - Press the button to select input source.

 / **MENU** - Press the button to enter projector menu.

 - Press the buttons to select screen item of projector menu.

 / **EXIT** - Press the button to exit the projector menu.

 - Press the buttons to fast search forward and rewind on USB / TF/DVD

 - Press the buttons to search next or previous file on USB / TF/DVD.

VOL+ / VOL- - Press the buttons to select correct sound.

 - Press the button to play/pause the connect USB / TF card/DVD.

FLIP – Press the button to rotate / mirror projector screen

ZOOM - Press the button to select image scale.

 - Press to muting the audio sound of your projector. Press again to resume.



■ **STOP**- Short press to stop the audio / video /Photo playback.

GOTO: Press it to go to a specific time index /title / chapter.

0-9 Number button - Use the number buttons to input a DVD chapter or CD track (invalid for some discs) and press **PLAY/PAUSE** button to confirm.

Connect HDMI Show The Image On Projector Screen

Follow below picture to connect HDMI cable and device.

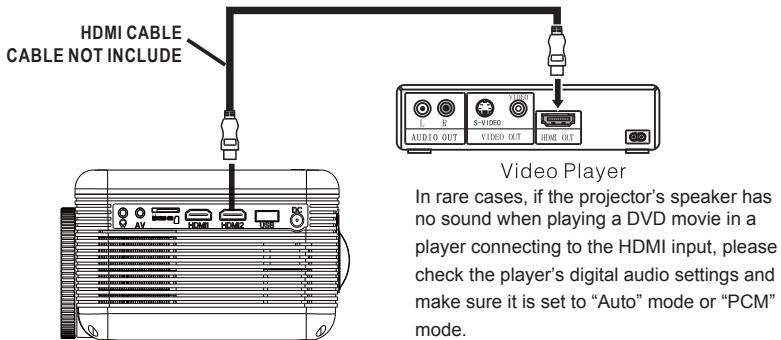

1. Turn off the unit before connect HDMI cable.
2. After connect, press the  button to turn on unit and power indicator will light GREEN
3. Press the  / **SOURCE** button to HDMI mode and the video of HDMI device will show on projector screen. There are 2 HDMI input, HDMI1 interface corresponds to HDMI 1 in SOURCE mode, and HDMI2 interface corresponds to HDMI 2 in SOURCE mode.
4. Press the  button to turn off unit power.

HDMI hd signal input : this interface can be input with HD player
HDMI output at the connection.



Connect AV Show The Image On Projector Screen



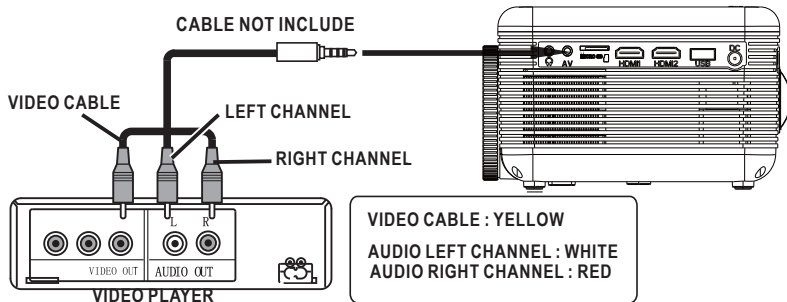

Follow below picture to connect AV cable and device.

1. Turn off the unit before connect AV cable.
2. Use AV cable to connect follow below figure
3. After connect, press the  button to turn on unit and power indicator will light GREEN
4. Press the  / **SOURCE** button to AV mode and the video of AV device will show on projector screen
5. Press the  button to turn off unit power.



Connect VGA Show The Image On Projector Screen

Follow below picture to connect HDMI cable and device.

1. Turn off the unit before connect VGA cable.
2. Press the  button to turn off power of your projector before connection.
3. After connect, press the  button to turn on unit and power indicator will light GREEN
4. Press the  / **SOURCE** button to VGA mode and the video of VGA device will show on projector screen.
5. Press the  button to turn off unit power.

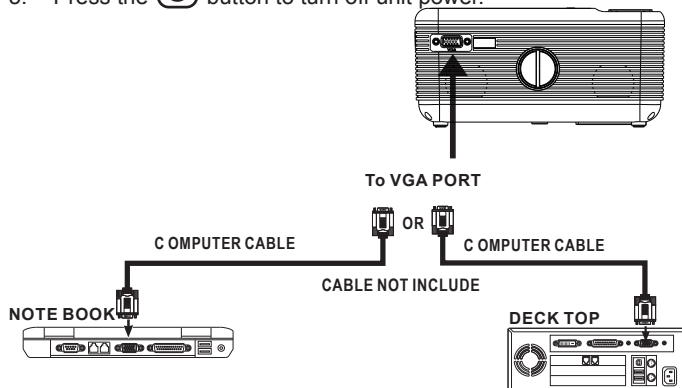

Please refer to the following table to adjust the output signal from computer

Type	Resolution		Frequency	Field Frequency
PC	VGA	640x480	31.5	60
			34.7	70
			37.9	72
			37.5	75
	SVGA	800x600	31.4	50
			35.1	56
			37.9	60
			46.6	70
			48.1	72
	XGA	1024x768	46.9	75
			40.3	50
			48.4	60
			56.5	70

Connect Audio Output (Aux Out / Line Out / Earphones)

Follow below picture to connect audio cable and device.

1. Press the  button to turn off power of your projector before connection.
2. Use audio cable to connect follow below figure.
3. After connect and turn on both units. Your projector sound from external device now.
4. After using , turn off both unit

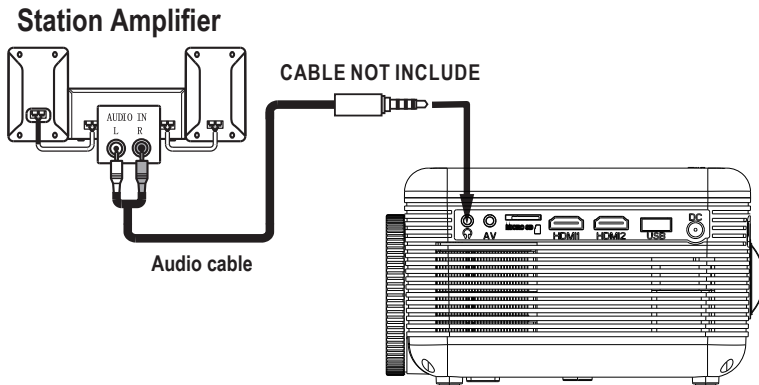

Install USB Device And Micro Sd Card “TF”

Follow below picture to install USB and TF card



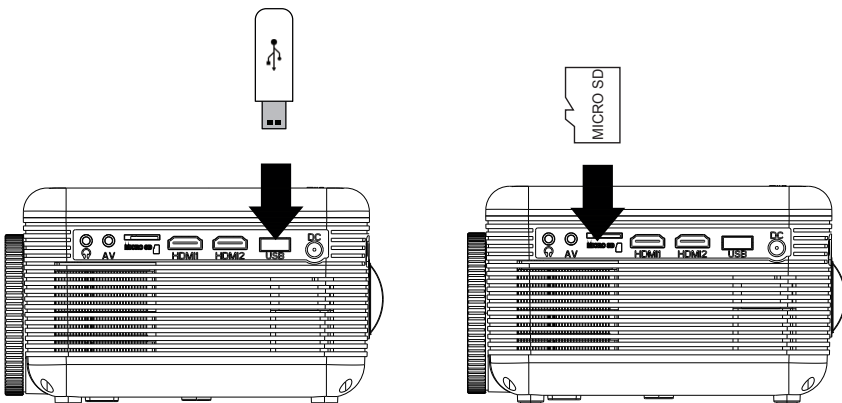











Turn off the unit before install USB / TF card.















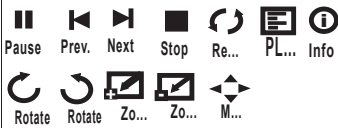

NOTE: In DVD mode, insert USB device and play . If resume back to play DVD after playing USB device, please make sure to remove USB device in advance.

Using TF Card And USB Playback (Media Player)







Install USB / TF device:

1. Turn off the unit before install USB / TF card.
2. Install the USB device into USB port.
3. After connect, press the  button to turn on unit and the power indicator light GREEN.
4. Press the  / **SOURCE** button to enter and use  buttons to search the MEDIAPLAYER mode.
5. After selection, use  buttons to search the MUSIC / PHOTO / MOVIE icon and press the  button to enter. If necessary, use the  /  button to select TF card or USB and press the  button to enter.
6. Use  buttons to search the correct file and press the  button to preview playback file and press the  button of unit or  button of remote to start playback.
7. Press  button to fast search forward and rewind.
8. Press  button to search next or previous file.
9. During playback, press the  button to pause and press again to resume.

NOTE: Remove USB / TF device, press the  button to turn off power **FIRST**.

Sub-Menu on Photo screen	
<ol style="list-style-type: none"> 1. When photo playback, press the  button and more function screen show on lower (figure 1). 2. Use the  /  button to select icon and press the  button to play special function. 	<p style="text-align: center;">Figure 1.</p> 
Sub-Menu on Music screen	
<ol style="list-style-type: none"> 3. When music playback, press the  button and more function screen show on lower (figure 2). 4. Use the  /  button to select icon and press the  button to play special function. 	<p style="text-align: center;">Figure 2</p> 
Sub-Menu on Movie screen	
<ol style="list-style-type: none"> 5. When movie playback, press the  button and more function screen show on lower (figure 3). 6. Use the  /  button to select icon and press the  button to play special function. 	<p style="text-align: center;">Figure 3</p> 

Using DVD playback









1. Press the  button to turn on unit and the power indicator light GREEN.
2. Press the  /SOURCE button to enter and use  / buttons to search the DVD mode.
3. Open the disc cover and insert a playable DVD or CD disc, make sure the label side is facing up, and then close disc cover.
4. The player will scan the disc, and then the playback will start automatically.
If a disc menu appears on the screen, see "Using the disc menu" for details.
5. Press  button to fast search forward and rewind.
6. Press  button to search next or previous file.
7. During playback, press the  button to pause and press again to resume.

Using Bluetooth Playback

Pairing is the term used when two Bluetooth devices are connected wirelessly for the first time. This allows the devices to see each other and sets up a one to one communication channel between both devices.









Bluetooth Connection

OSD Language	English
Bluetooth	
Restore Factory Default	
Panel Rotate	0
Info	

1. Press the  button to turn on unit.
2. Press the  button to enter the menu screen.
3. Use the  /  button to select right side menu.
4. Use the  /  button to select Bluetooth column.
5. Press the  button to enter Bluetooth menu.
6. Use the  /  button to select " ON"
7. Turn on your External Bluetooth Speaker and select to Bluetooth pairing mode
8. A few seconds, you hearing " do" sound that your unit and external Bluetooth speaker connected.
9. After connection completed, the unit sound to External Bluetooth speaker.

Note: When the BT can't connect to this device automatically. Please enter to the Bluetooth setup menu and select to the BT Reset to reset it, after that the BT device will be connected with this Projector automatically.



Disconnect the Bluetooth

1. Press the  button to enter the menu screen.
2. Use the  /  button to select above menu.
3. Use the  /  button to select Bluetooth column.
4. Press the  button to enter Bluetooth menu.
5. Use the  /  button to select " OFF" that the Bluetooth disconnect.

Using Projector Menu 1.0

Press  button to enter projector menu. Press again to previous status.

Picture Mode	Standard
Contrast	50
Brithness	50
Color	50
Sharpness	50
Tint	50
Color Temperature	Medium
Aspect Ratio	Auto
Noise Reduction	Middle
Screen	

Use   buttons to select manual page.
This manual showed on right upper of view screen.

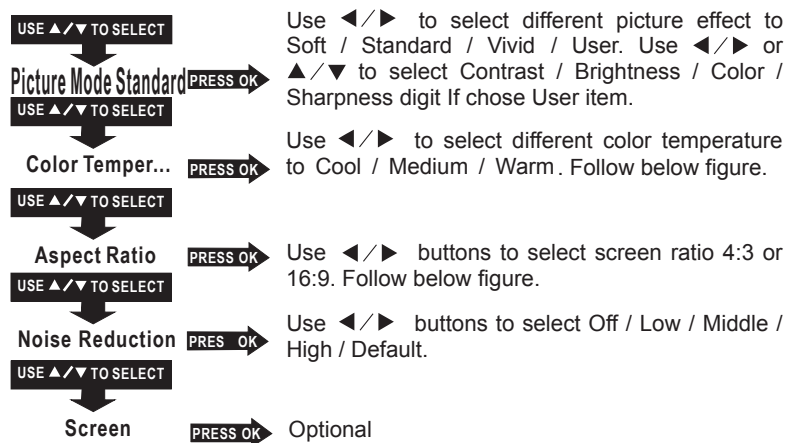



Color temper... (temperature)	
Customer define	Parameter
red	0-100
blue	0-100
green	0-100

Aspect Ratio	
4:3	The signal in a 4:3 aspect ratio projection image
16:9	The signal in a 16:9 aspect ratio projection image

Using Projector Menu 2.0

Press  button to enter projector menu. Press again to previous status.



Sound Mode Standard	
Treble	50
Bass	50
Balance	0
Auto Volume	Off
Surround Sound	Off

Use   buttons to select manual page.
This manual showed on right upper of view screen.

USE ▲/▼ TO SELECT

Sound Mode Standard

PRESS OK

Use   to select different sound effect Standard / Movie / Music / Sports / User. If select User, follow below figure to set digit.

USE ▲/▼ TO SELECT

Balance 0

PRESS OK

Use   to select Balance level to 0-50.

USE ▲/▼ TO SELECT

Auto Volume Off

PRESS OK

To select Off / On.

USE ▲/▼ TO SELECT

Surround Sound Off

PRESS OK

Use ▲/▼ to select different sound effect to Off / Surround.

Sound Mode - User	Parameter
Treble	0-100
Bass	0-100

Using Projector Menu 3.0

Press  button to enter projector menu. Press again to previous status.

OSD Language	English
Bluetooth	
Restore Factory Default	0
Panel Flip Rotate	
Info	

Use  buttons to select manual page. This manual showed on right upper of viewing screen.

USE ▲/▼ TO SELECT

OSD Language

PRESS OK

Use  button to select different language. Follow below figure.

USE ▲/▼ TO SELECT

Bluetooth

PRESS OK

To select Off / On for Bluetooth connect. Set to "ON" to turn on Bluetooth function.

USE ▲/▼ TO SELECT

Restore Factory Default

PRESS OK

Use ◀/▶ buttons to select Y or N. If choose "Y" that your unit will go to factory default setting.

USE ▲/▼ TO SELECT

Panel Flip Rotate 0

PRESS OK

Use ◀/▶ to select rotate 0 / rotate 1 / rotate 2 / rotate 3 to set screen angle.

USE ▲/▼ TO SELECT

INFO

PRESS OK

RCA
SW Ver: V7.0
LOGO: RCA
FL040CT_30

English	Hrvatski	Nederlands	Chinese
Franais	Deutech	Slovenina	Slovak
Espanol	Italiano	Norsk	
Portugues	Magyar	Srpski	
Esky	Polski	Svenska	
Dansk	Romnete	Suomi	

Using Projector Menu 4.0

Press  button to enter projector menu. Press again to previous status.

Clock - - -
Off Timer Off
On Timer Off
Sleep Timer Off
Auto Sleep Never

Use  buttons to select manual page.

This manual showed on right upper of viewing screen.

USE ▲/▼ TO SELECT

Clock - - -

PRESS OK

Use ◀/▶ / ▲/▼ to select clock to Day / Month / Year / Hour / Minutes.

USE ▲/▼ TO SELECT

Off Timer Off

PRESS OK

Use ◀/▶ / ▲/▼ to select timer turn off to Day / Hour / Minutes.

USE ▲/▼ TO SELECT

On Timer Off

PRESS OK

Use ◀/▶ / ▲/▼ to select timer turn on to Day / Hour / Minutes.

USE ▲/▼ TO SELECT

Sleep Timer Off

PRESS OK

To select sleep timer turn to Off / 10min / 20min / 30min / 60min / 90min / 120min / 180min / 240min.

USE ▲/▼ TO SELECT

Auto Sleep Never

PRESS OK

To select auto sleep function to turn Never / 4 hour / 6 Hour / 8 hour.

DVD SETUP

General Setup:

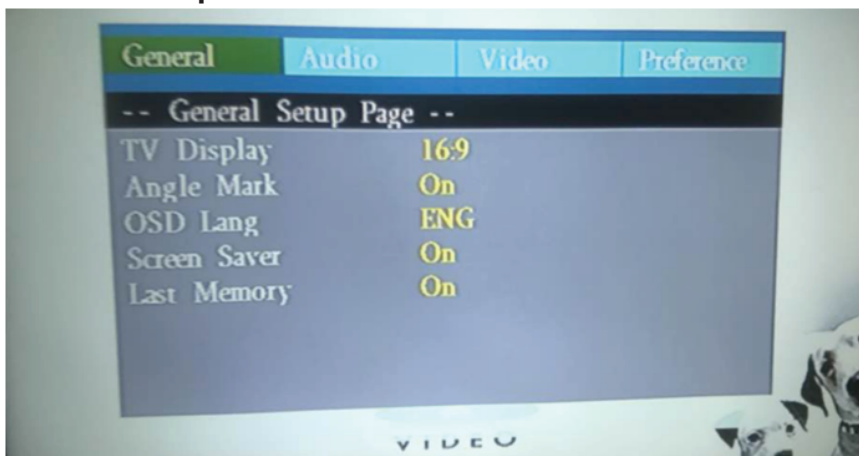

TV Display:

Sets the aspect ratio of the playback image when using an external television display.

4:3 Panscan - a 4:3 aspect ratio that will trim the left and right sides off of a widescreen film. Also known as fullscreen.

4:3 Letterbox - select this if you have a standard 'square' television (4:3 aspect ratio). The full image will be shown on the screen with black letterbox bars on the upper and lower portions of the image.

16:9 - Choose this display option on any widescreen display (most HDTVs).

Angle Mark: Displays current camera viewing information on the right hand corner of the TFT screen if available on the disc. Note that this function only works with those discs encoded with multiple camera angles.

OSD Language: Change the DVD player system language
Screen Saver: Use this setting to turn the screen saver on or off after a period of prolonged DVD player inactivity.
Last Memory: Set this to ON so that, each time you turn off the unit or stop the disc, the last point of play will be retained. On the next time you turn on the unit and play the same disc, the unit will play from that point.

Audio Setup:

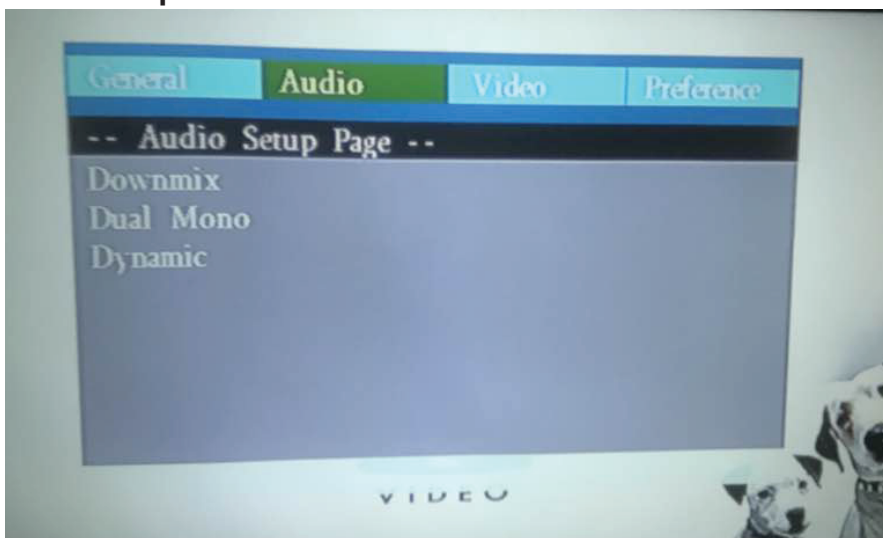

Here, you can change the audio setup of the portable DVD player:

Downmix:

LT/RT - Select this option if your DVD player is connected to a Dolby Pro Logic decoder.

Stereo - Select this option when output delivers sound from only the two front speakers.

Dual Mono:

L Mono/R Mono /Mix Mono/Stereo these four audio mode select for VCD/Mp3 audio output

Dynamic:

From Full to 1/8 set when audio is too large then System can do Dynamic to control decrease audio output range

Audio Setup:



These are settings for the video quality of the DVD output to display: Sharp, BRIGHTNESS, CONTRAST, HUE, SATURATION For Sharp setting, there are three options: High, Medium, Low. Enter these items respectively. Other Setting Use direction key LEFT/RIGHT to adjust the value. Then press OK

Preferences

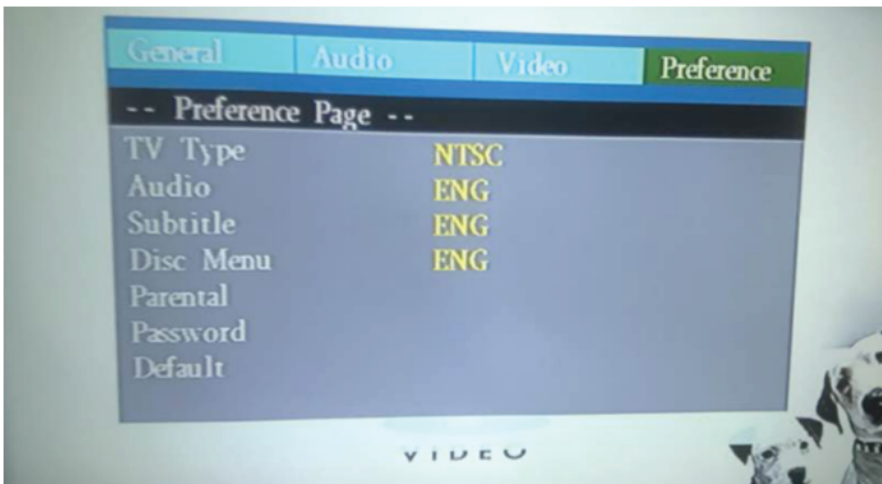

TV Type: This DVD player is compatible with both NTSC and PAL televisions. Choose either NTSC (US/Americas/Japan) or PAL (Europe/Asia) TV output settings to correspond your television. Use to select the TV types, include PAL/AUTO/NTSC.

NTSC - Select this signal when connected to a NTSC television. The output of PAL discs will automatically be converted to NTSC format. PAL - Select this signal when connected to a PAL television. The output of NTSC discs will automatically be converted to PAL format. Auto-select this, video output will auto select TV PAL/NTSC by video source. For example, when in logo state, will output NTSC format; if playing a PAL DVD video, will output PAL format....

Audio/Subtitle/Disc menu language select will control the DVD disc playing for its DISC audio select, subtitle output select and DVD Disc Menu language select.

Parental-setting Limits playing DVD by KID/Adult age to watching some video. If user want to change this setting, need input password by setted in password item.

Password-setting is to change password, default is 0000 Default—this item is used by user to restore the default setting.

Specifications

Light Source Type	LED
Brightness Output	White light output ANSI: 33 Lumens White brightness output ANSI: 33.1 Lumens
Display Native Resolution	800 x 480
HDMI Input Supported Video Resolution.	1080p , 1080i , 720p, 576i , 480p, and 480i
Power Consumption	Operating 48W; Standby 0.8W
Power Input Connect Included Adapter	DC 12V , 4A
Included Adapter Connect DC input of unit	Input AC100-240V,50/60Hz Output DC12V , 4A
Display Color	16.7K
Projection Size	30-100 inch
Signal Port	Video / VGA / HDMI
USB Port	Support USB device up to 32GB Support format mpeg1, Mpeg2 ,mpeg4, mp3 , Jpeg
MICRO SD	Support MICRO SD card up to 32GB Support format mpeg1, Mpeg2 ,mpeg4, mp3 , Jpeg
Weight	0.9 KG
Dimension	203 x 161 x 95 mm

Installation Instructions

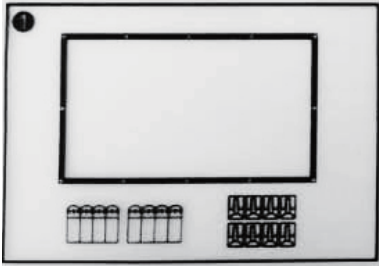

1. Simple screen package includes screen fabric, hooks and double-side adhesive tapes.

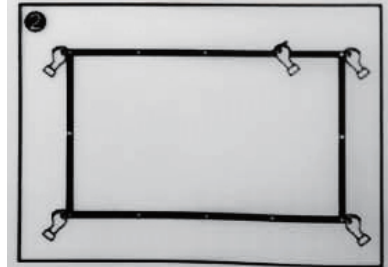

2. First of all, pull the screen fabric flat and lay it on the wall where it will be installed. Mark every position of the grommets correctly on the wall.

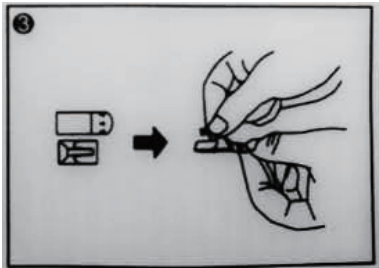

3. Second, stick each hook on an adhesive tape.

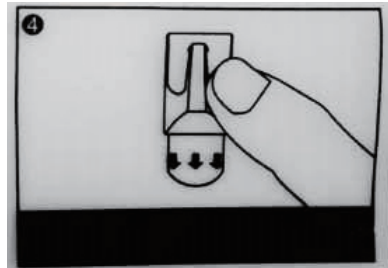

4. Then stick the hooks with the tapes on every position marded on the wall.

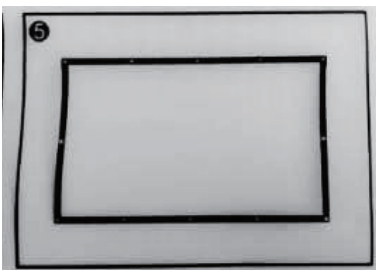

5. Finally, put the screen flat by hanging the grommets on the relevant hooks.

TROUBLESHOOTING

Before resorting the maintenance service, please kindly check by yourself with the following chart.

<p>No Image is Projected or a "No Signal" message is displayed</p>	<ol style="list-style-type: none"> 1. Power light is on. If it is not on, check the projector is plugged into the mains, that the socket is switched on, and then press the power button on the projector. 2. Check the lens cover has been removed. 3. Check the cables are securely attached and installed as per the User Manual. 4. The image source may not be set correctly. Press the Source button on the Control Panel or the Remote, to select the correct setting. 5. Check in the Menu section under Video input signal to make sure that has been set correctly.
<p>The Lamp (Bulb) switches off after a period of time</p>	<p>Is the warning light indicator red? If so, the projector is overheating which turns the light off automatically.</p> <ol style="list-style-type: none"> 1. Leave the projector to cool for a few moments. 2. Once cooled, check nothing is blocking the ventilation vents. 3. Check the air filter is clean and clean if necessary. 4. Turn on the projector. <p>If the issue persists please contact your support provider for further assistance.</p>
<p>The Image is wider at the top/bottom of the screen</p>	<p>This is called keystone and is due to the projection angle not being perpendicular to the screen. To correct use the projectors inbuilt keystone function to adjust the image.</p>
<p>Spots on the screen</p>	<p>Using a vacuum cleaner to clean the lens. If cleaning doesn't resolve things, please contact your support provider for further assistance.</p>
<p>The image brightness has faded</p>	<p>This could possibly be caused by the ambient light in the room. If not, the chances are that you need to replace the lamp (bulb).</p>

For service assistance and product information, please call: **1-800-968-9853**.

Pour obtenir assistance et information appelez: **1-800-968-9853**.

Curtis International Ltd.

7045 BECKETT DRIVE, UNIT 15,

MISSISSAUGA, ON, L5S 2A3 www.curtisint.com

To make a warranty claim, please email support@curtiscs.com or call 1-800-968-9853.

90 day Warranty

This product is warranted to be free from defects in material and workmanship for a period of ninety (90) days from the date of original purchase. During this period, your exclusive remedy is repair or replacement of this product or component found to be defective, at our option; however, you are responsible for all costs associated with returning the product to us. If the product or component is no longer available, we will replace with a similar one of equal or greater value. Prior to a replacement being sent, the product must be rendered inoperable or returned to us.

This warranty does **not** cover glass, filters, wear from normal use, use not in conformity with the printed directions., or damage to the product resulting from accident, alteration, abuse, or misuse. This warranty extends only to the original consumer purchaser or gift recipient. Keep the original sales receipt, as proof of purchase is required to make a warranty claim. This warranty is void if the product is used for other than single-family household use or subjected to any voltage and waveform other than as on the specified rating on the label (e.g., 120V~60Hz).

We exclude all claims for special, incidental, and consequential damages caused by breach of express or implied warranty. All liability is limited to the amount of the purchase price. **Every implied warranty, including any statutory warranty or condition of merchantability or fitness for a particular purpose, is disclaimed except to the extent prohibited by law, in which case such warranty or condition is limited to the duration of this written warranty.** This warranty gives you specific legal rights. You may have other legal rights that vary depending on where you live. Some states or provinces do not allow limitations on implied warranties or special, incidental, or consequential damages, so the foregoing limitations may not apply to you.

For faster service, locate the model, type, and serial numbers on your appliance.

ATTACH YOUR PROOF OF PURCHASE HERE, PROOF OF PURCHASE IS REQUIRED TO OBTAIN WARRANTY SERVICE.

Please have the following information available when you contact the Support Team:

- Name, address and telephone number.
- Model number and serial number.
- A clear, detailed description of the problem.
- Proof of purchase including dealer or retailer name, address and date of purchase.