

EKEA Telecom

H1 Pro

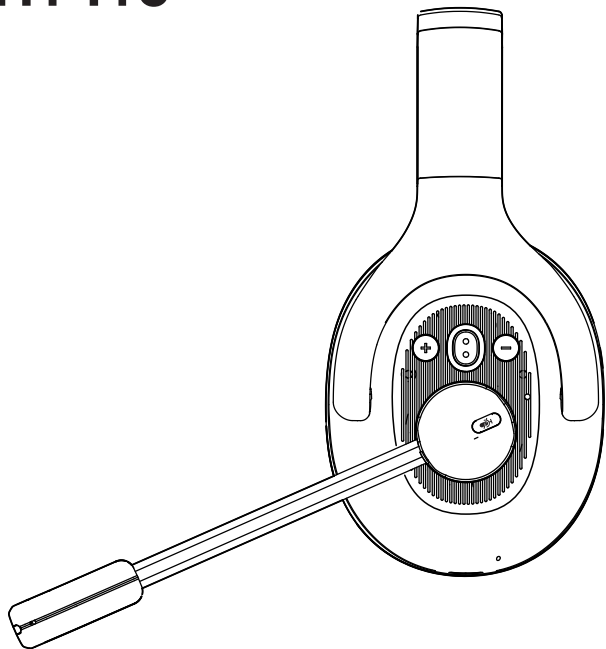

User Manual



Language Guide

English **1**

日本語 **9**

Français **17**

Deutsch **25**

Español **33**

Italiano **41**



Package Contents

- ① EKSAtelcom H1 Pro Wireless Headset
- ② Type-C Charging Cable
- ③ Carry Pouch
- ④ User Manual
- ⑤ Replacement Ear Pad

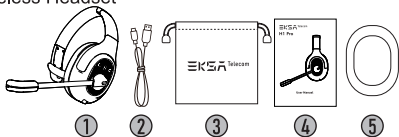

Specifications



Bluetooth Version: 5.0

Effective Wireless Range: 30 m / 99 ft
(Max 50 m / 164 ft without obstacles)



Music Time: \approx 57 hours (70% volume)

Talk Time: \approx 30 hours (70% volume)

Charging Time: \approx 1.5 hours



Speaker Diameter: 40 mm

Impedance: $32 \Omega \pm 15\%$

Sensitivity: 114 ± 3 dB

Frequency Response: 20 Hz – 20 kHz



Size: 2.7 mm * 1.85 mm

Sensitivity: -25 ± 1 dB

Frequency Response: 100 Hz – 10 kHz

Impedance: 2.2 k Ω







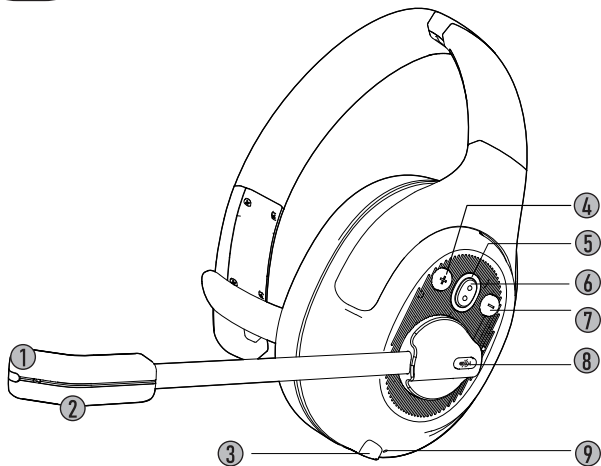

Polar Pattern: Omnidirectional

Mic: EKSAtelcom VoicePure Technology



Product Overview



- ①  Call Indicator
- ②  EKSAtelecom VoicePure Technology
- ③  Type-C Charging Port
- ④  Volume +
- ⑤  Bluetooth Indicator
- ⑥  Multi-Function Button (MFB)
- ⑦  Volume -
- ⑧  Mic Mute Button
- ⑨  Charging Indicator



Operation Guide



Multi-Function Button:

  Press for 3 seconds: Headphone on/off

  Click: Play/Pause

  Triple Click: Voice Assistant/Siri



Volume Button:

   Click: Volume + / -

   Press for 2 seconds to next/previous track



Mic Mute Button:

  Click: Microphone on/off



Call Functions

Call Handling:

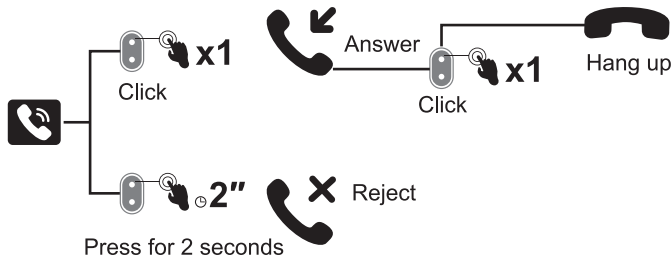

Redial:

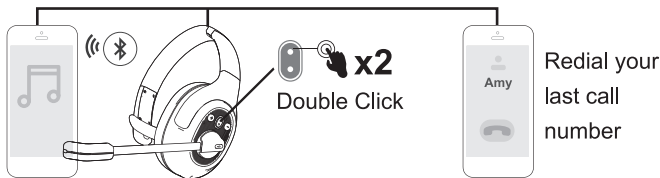

Audio Switching:

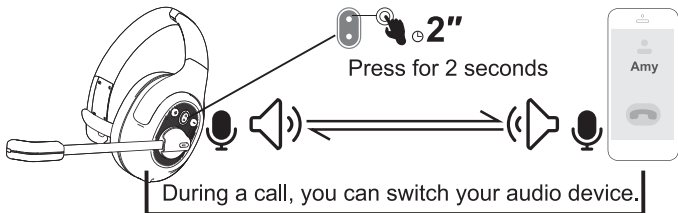



Call Functions

Three-Way Calling:

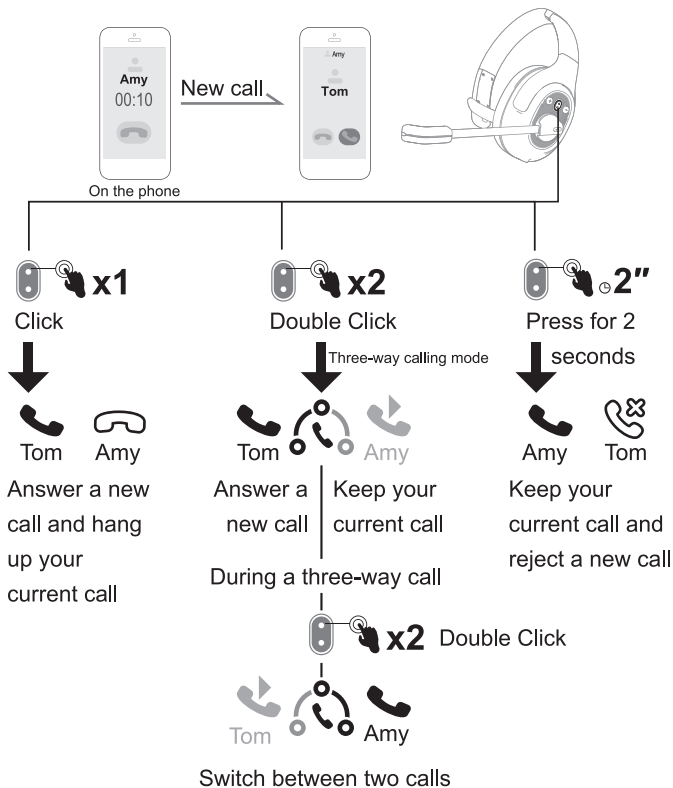



Bluetooth Pairing

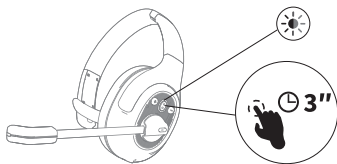

1. Turn on EKSAtelcom H1 Pro, until its Bluetooth indicator flashes alternately between red and blue, indicating that the headset is in pairing mode.

2. Turn on the Bluetooth of your device, activate the search feature, and select "EKSA-H1 Pro". After pairing, the Bluetooth indicator flashes slowly in blue light with a voice prompt **"your headset is connected"**, confirming a successful connection.

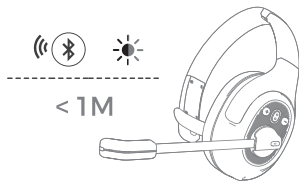
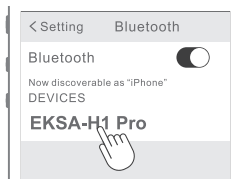

Note:

1. Keep the distance between the EKSAtelcom H1 Pro and your device within 1 meter.
2. If necessary, the pin code to complete pairing is "0000".
3. While in pairing state, if a connection cannot be established within 10 minutes, the headset will turn off automatically.
4. When the headset is turned on again, it will connect to the last connected device automatically.
5. Compatibility issues may arise when connecting directly to a computer via Bluetooth. Preferably with an adapter (not included).

3. To connect to a new device, turn off the Bluetooth of the currently paired device and follow the above steps to connect successfully to a new device.

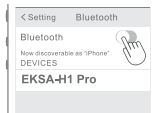

device A

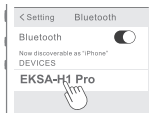

device B





Dual Pairing

1. After successfully connecting the EKSAtelecom H1 Pro to device A, turn off the Bluetooth of device A. The headset's Bluetooth indicator flashes in red and blue alternately to signify pairing mode.

device A

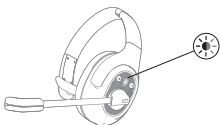

2. Turn on the Bluetooth of device B, activate search mode, and connect to "EKSA-H1 Pro".



device B

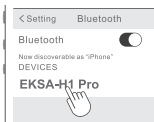

device B



3. Turn on the Bluetooth of device A to connect with "EKSA-H1 Pro". This puts both devices A and B in a simultaneous connection with "EKSA-H1 Pro".

device A



Reset

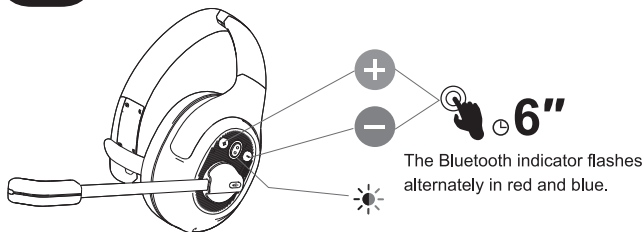

When EKSatelecom H1 Pro is in connected/pairing mode, press and hold the "volume +" and "volume -" buttons simultaneously for 6 seconds until the LED lights up in red and blue, indicating the pairing information is cleared.

Charging

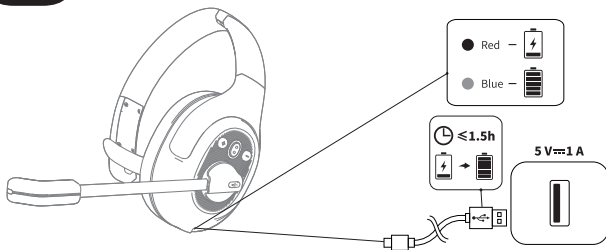

1. When the battery is less than 10%, the headset will give a voice prompt **"battery low"** every 3 minutes. Please charge it as soon as possible.
2. When EKSatelecom H1 Pro is not in use, please charge it at least once every 2 months.
3. Please use the original charging cable for charging. Charging voltage can't exceed 5 V.



パッキングリスト

- ① EKSAtelecom H1 Pro ワイヤレスヘッドセット
- ② Type-C 充電ケーブル
- ③ キャリーポーチ
- ④ ユーザーマニュアル
- ⑤ 付け替え可能なイヤークッション

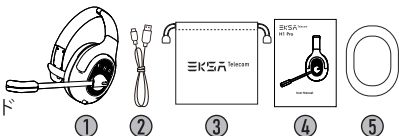

スペック

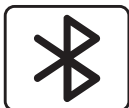

Bluetooth バージョン: 5.0
 ワイヤレス有効範囲: 30 m / 99 ft
 最大 50メートル (障害物なし)



音楽再生時間: 約57 時間 (音量70%)
 通話時間: 約30 時間 (音量70%)
 充電時間: 約1.5 時間



スピーカー直径: 40 mm
 インピーダンス: $32 \Omega \pm 15\%$
 感度: $114 \pm 3 \text{ dB}$
 周波数特性: 20 Hz ~ 20 kHz



サイズ: 2.7 mm * 1.85 mm
 感度: $-25 \pm 1 \text{ dB}$
 周波数特性: 100 Hz ~ 10 kHz
 インピーダンス: 2.2 k Ω
 マイク指向性: 無指向性
 マイク: EKSAtelecom VoicePure技術



商品概要

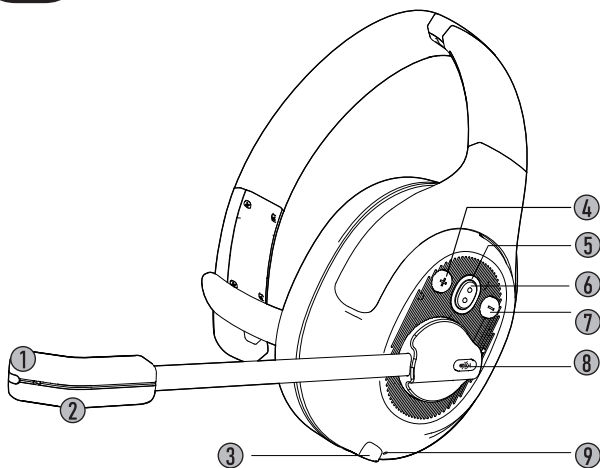

- ①  通話インジケータ
- ②  EKSAtelcom VoicePure技術
- ③  Type-C 充電ポート
- ④  音量+
- ⑤  Bluetooth インジケータ
- ⑥  マルチファンクションボタン (MFB)
- ⑦  音量-
- ⑧  マイクミュートボタン
- ⑨  充電用インジケータ







操作ガイド



マルチファンクションボタン:

  3秒間押す: ヘッドセット オン/オフ

  クリック: 再生/一時停止

  トリプルクリック: 音声アシスタント/Siri

+ / - 音量ボタン:

    クリック: 音量 +/-

    2秒間押すと次の曲/前の曲へ



マイクミュートボタン:



クリック: マイクのオン/オフ



通話機能

通話対応:

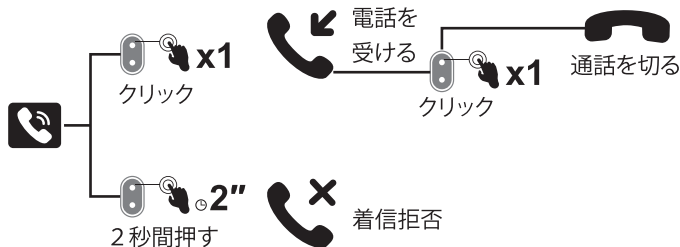

リダイヤル:



オーディオの切替:





通話機能

3者通話:

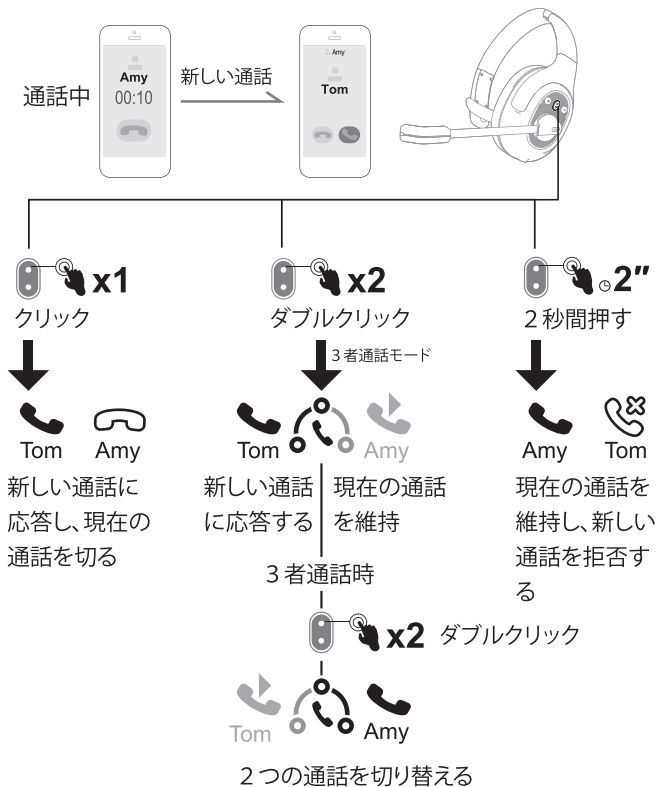



Bluetoothペアリング

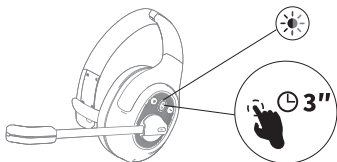

1. EKSAtelecom H1 ProのBluetoothインジケータが赤と青の間で交互に点滅し、ヘッドセットがペアリングモードであることを示すまで、電源をオンにします。

2. お使いのデバイスのBluetoothをオンにして、検索機能を有効にし、「EKSA-H1 Pro」を選択します。ペアリング後、Bluetoothインジケータが青くゆっくり点滅し、「**your headset is connected**」と音声を出て来て、ペアリングが完了です。

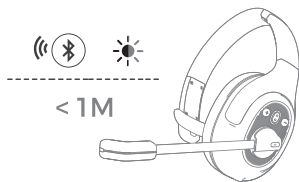
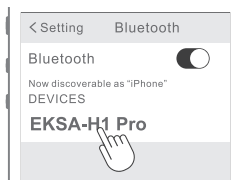

注意:



1. EKSAtelecom H1 Proとペアリングする機器との距離は1m以内にしてください。
2. 必要に応じて、ペアリングを完了するためのPINコードは ""0000""です。
3. ペアリング状態で10分以内に接続が確立できない場合、ヘッドセットは自動的にオフになります。
4. ヘッドセットを再度オンにすると、最後に接続したデバイスに自動的に接続されます。
5. 部分のコンピューター自身のシステムにより、BluetoothでH1 Proヘッドセットが接続できない場合があります。PC側はUSB dongleでの使用をお勧めします。(別売り)

3. 新しいデバイスに接続する場合は、ペアリングしているデバイスのBluetoothをオフにして、上記の手順で新しいデバイスに正常に接続できます。

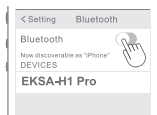

デバイスA

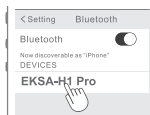

デバイスB





デュアルペアリング

1. EKSAtelecom H1 ProをデバイスAに正常に接続した後、デバイスAのBluetoothをオフにします。ヘッドセットのBluetoothインジケータが赤と青に交互に点滅し、ペアリングモードであることを知らせます。

デバイスA

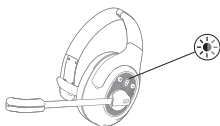

2. デバイスBのBluetoothをオンにし、サーチモードを有効にして、「EKSA-H1 Pro」に接続します。



デバイスB

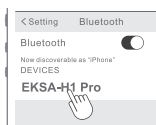

デバイスB



3. デバイスAのBluetoothをオンにし、「EKSA-H1 Pro」と接続します。これにより、デバイスAとデバイスBの両方が「EKSA-H1 Pro」と同時に接続された状態になります。

デバイスA



リセット

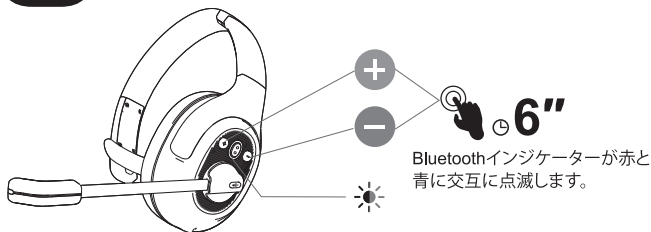

EKSatelecom H1 Proが接続/ペアリングモードのとき、「音量+」「音量-」ボタンを同時に6秒間長押しすると、LEDが赤と青に点灯し、ペアリング情報がクリアされたことを示します。

充電

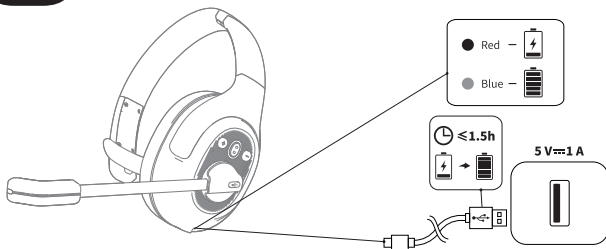

1. バッテリーが10%以下になると、ヘッドセットは3分ごとに「**battery low**」という音声プロンプトを出します。できるだけ早く充電してください。
2. EKSatelecom H1 Proを使用しない場合は、2ヶ月に1回以上の充電をお願いします。
3. 充電には純正の充電ケーブルをご使用ください。充電の電圧は5Vを超えることはできません。



Contenu du Product

- ① Casque sans fil H1 Pro EKSAtelecom
- ② Câble de charge de type C
- ③ Pochette de transport
- ④ Manuel de l'Utilisateur
- ⑤ Oreillettes remplaçables

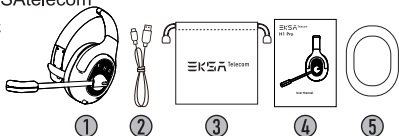

Spécifications

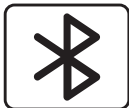

Version du casque Bluetooth : 5.0

Portée sans fil efficace : 30 m / 99 pieds
(Max. 50 mètres sans obstacles)



Temps de musique : ≈57 heures (70 % de volume)

Temps de conversation : ≈30 heures (70 % de volume)

Temps de charge : ≈1,5 heures



Diamètre du haut-parleur : 40 mm

Impédance : $32 \Omega \pm 15 \%$

Sensibilité : 114 ± 3 dB

Réponse en fréquence : 20 Hz - 20 kHz



Taille : 2,7 mm * 1,85 mm

Sensibilité : -25 ± 1 dB

Réponse en fréquence : 100 Hz - 10 kHz

Impédance : 2,2 k Ω







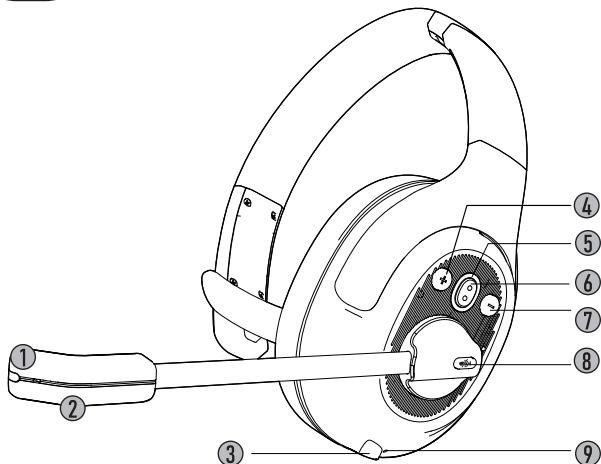

Diagramme polaire : omnidirectionnel

Micro : EKSAtelecom VoicePure Technologie



Présentation du produit



- ①  Indicateur d'appel
- ②  EKSAtelcom VoicePure Technologie
- ③  Port de charge de type C
- ④  Volume +
- ⑤  Indicateur Bluetooth
- ⑥  Bouton Multi-Fonction (BMF)
- ⑦  Volume -
- ⑧  Bouton de désactivation du micro
- ⑨  Indicateur de charge



Guide d'opération



Bouton Multi-Fonction :



Appuyez pendant 3 secondes :
Casque activé/désactivé



Cliquez sur : Lecture/Pause



Triple clic : Assistant vocal/Siri



Bouton Volume :



Clic : Volume + / -



Appuyez pendant 2
secondes sur la piste
suivante/précédente



Bouton de désactivation du micro :



Clic : Microphone activé/désactivé



Fonctions d'appel

Traitement des appels :

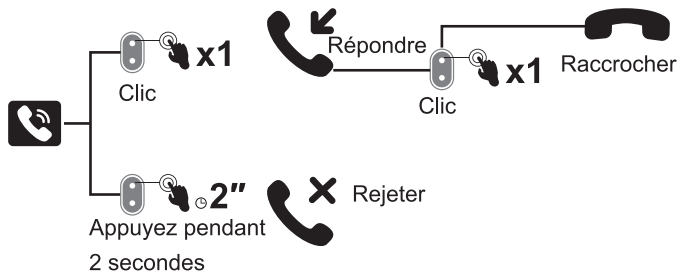

Recomposer :

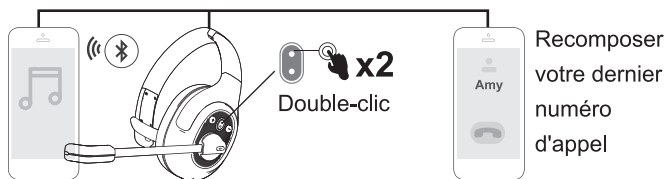

Commutation audio :

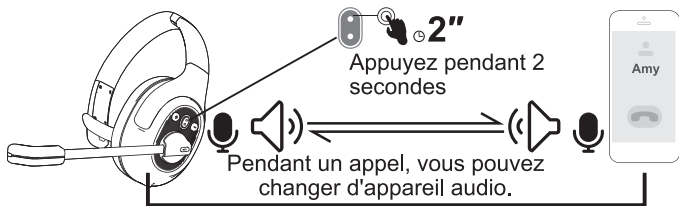



Fonctions d'appel

Appel à trois :

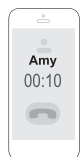

Nouvel appel

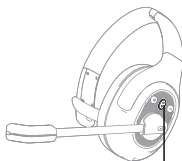

Au téléphone



Clic



Tom

Amy

Répondre à un nouvel appel et raccrocher votre appel en cours



Double-clic

Mode d'appel à trois



Tom

Amy

Répondre à un nouvel appel pendant un appel à trois



Double-clic



Tom

Amy

Basculer entre deux appels



Appuyez pendant



2 secondes



Amy

Tom

Gardez votre appel en cours et rejetez un nouvel appel



Appairage Bluetooth

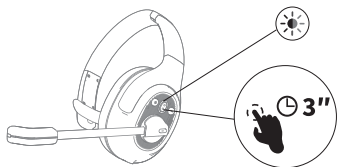

1. Allumez l'EKSAtelcom H1 Pro, jusqu'à ce que son indicateur Bluetooth clignote alternativement entre le rouge et le bleu, indiquant que le casque est en mode appairage.

2. Activez le Bluetooth de votre appareil, activez la fonction de recherche et sélectionnez "EKSA-H1 Pro". Après l'appairage, l'indicateur Bluetooth clignote lentement en bleu avec une invite vocale **"your headset is connected"**, confirmant une connexion réussie.

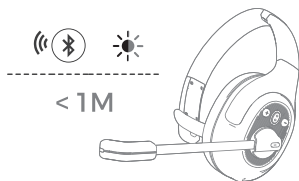
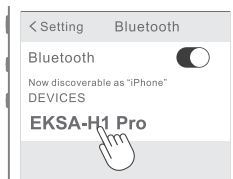

Noter :

1. Assurez-vous que la distance entre l'EKSAtelcom H1 Pro et l'appareil doit être inférieure à 1 mètre.
2. Si nécessaire, le code PIN pour terminer l'appairage est "0000".
3. Pendant l'état d'appairage, si une connexion ne peut pas être établie dans les 10 minutes, le casque s'éteindra automatiquement.
4. Lorsque le casque est rallumé, il se connectera automatiquement au dernier appareil connecté.
5. Il peut y avoir des problèmes de compatibilité avec la connexion à un ordinateur via Bluetooth. Il est préférable d'utiliser un adaptateur pour se connecter (non inclus).

2. Pour vous connecter à un nouvel appareil, désactivez le Bluetooth de l'appareil actuellement jumelé et suivez les étapes ci-dessus pour vous connecter avec succès à un nouvel appareil.

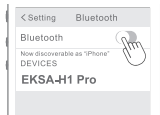

appareil A

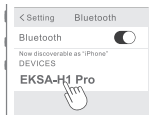

appareil B





Double couplage

1. Après avoir réussi à connecter l'EKSAtelcom H1 Pro à l'appareil A, désactivez le Bluetooth de l'appareil A. L'indicateur Bluetooth du casque clignote alternativement en rouge et bleu pour indiquer le mode d'appairage.

appareil A

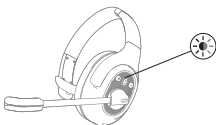

2. Activez le Bluetooth de l'appareil B, activez le mode de recherche et connectez-vous à l'"EKSA-H1 Pro".



appareil B

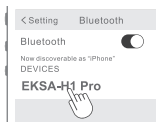

appareil B



3. Activez le Bluetooth de l'appareil A pour vous connecter à "EKSA-H1 Pro". Cela place les deux appareils A et B dans une connexion simultanée avec "EKSA-H1 Pro".

appareil B





Réinitialiser

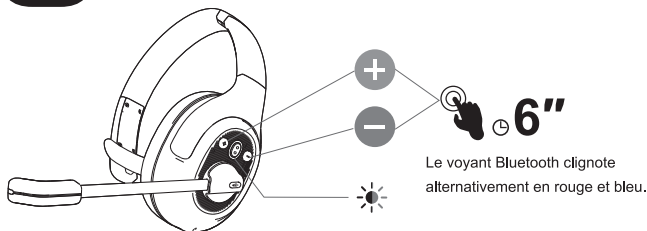

Lorsque l'EKSatelecom H1 Pro est en mode connecté/appairage, appuyez simultanément sur les boutons "volume +" et "volume -" et maintenez-les enfoncés pendant 6 secondes jusqu'à ce que le voyant s'allume en rouge et bleu, indiquant que les informations d'appairage sont effacées.



Mise en charge

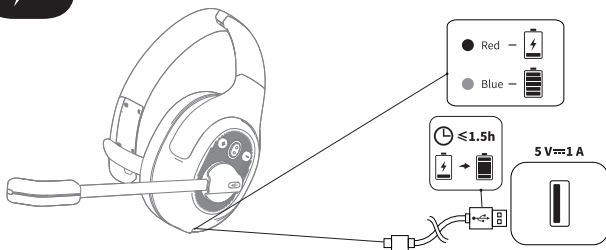

1. Lorsque la batterie est inférieure à 10 %, le casque émet une invite vocale **"battery low"** toutes les 3 minutes. Veuillez le charger dès que possible.
2. Lorsque l'EKSatelecom H1 Pro n'est pas utilisé, veuillez le charger au moins une fois tous les 2 mois.
3. Veuillez utiliser le câble de charge d'origine pour le chargement. La tension de charge ne peut pas dépasser 5 V.



Verpackungsliste

- ① EKSAtelecom H1 Pro Wireless Headset
- ② Typ-C Ladekabel
- ③ Tragetasche
- ④ Benutzerhandbuch
- ⑤ Ersatz-Ohrpolster

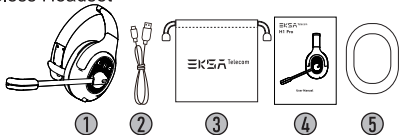

Technische Daten



Bluetooth Version: 5.0

Effektive drahtlose Reichweite: 30 m / 99 ft
(Ohne Hindernisse max. 50 Meter)



Musikzeit: ≈ 57 Stunden (70 % Lautstärke)

Sprechzeit: ≈ 30 Stunden (70 % Lautstärke)

Ladezeit: ≈ 1,5 Stunden



Lautsprecher-Durchmesser: 40 mm

Impedanz: $32 \Omega \pm 15 \%$

Empfindlichkeit: 114 ± 3 dB

Frequenzgang: 20 Hz – 20 kHz



Größe: 2,7 mm * 1,85 mm

Empfindlichkeit: -25 ± 1 dB

Frequenzgang: 100 Hz – 10 kHz

Impedanz: 2,2 k Ω







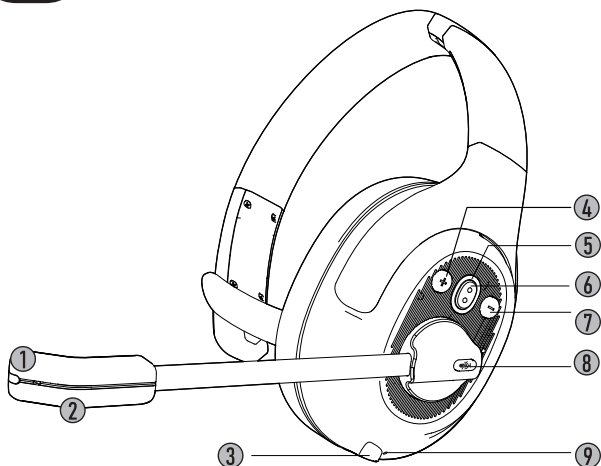

Ausrichtung: Omnidirektional

Mikrofon: EKSAtelecom VoicePure Technologie



Produktübersicht



- ①  Anrufanzeige
- ②  EKSAtelecom VoicePure Technologie
- ③  Typ-C-Ladeanschluss
- ④  Lautstärke +
- ⑤  Bluetooth Anzeige
- ⑥  Multi-Function Button (MFB)
- ⑦  Lautstärke -
- ⑧  Mikrofon-Stummschalttaste
- ⑨  Ladeindikator



Bedienerführung



MFB:



3 Sekunden drücken: Ein/Aus



Klicken: Abspielen/Pause



Siri



Dreifach-Klick: Sprachassistent/Siri



Lautstärketaste:



Klicken: Lautstärke + / -



2 Sekunden drücken:
Nächster/Vorheriger Titel



Mikrofon-Stummschalttaste:



Klicken: Mikrofon ein/aus



Anruffunktionen

Anrufbearbeitung:

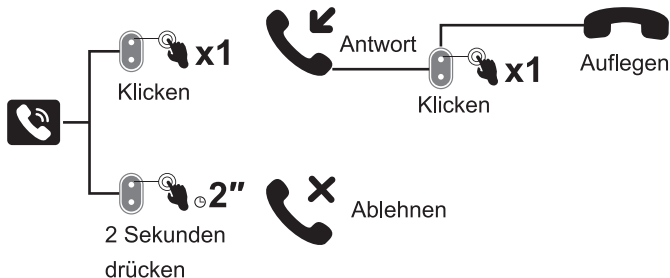

Wahlwiederholung:

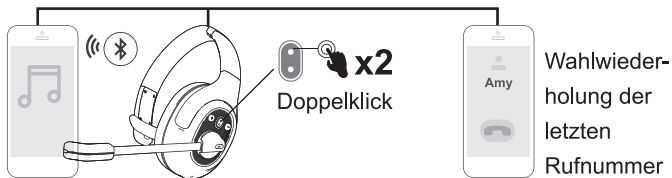

Audio-Umschaltung:





Anrufbearbeitung



Neuer Anruf:

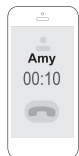

Am Telefon

Neuer
Anruf

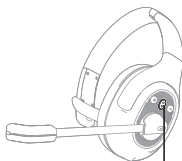

Klicken



Neuen Anruf
annehmen und
den aktuellen
Anruf auflegen



Doppelklick

Modus für
Drei-Wege-Gespräche



Neuen Anruf
annehmen | Den aktuellen
Anruf
beibehalten
Während eines
Drei-Wege-Gesprächs



2 Sekunden

drücken



Aktuellen Anruf
halten und
neuen Anruf
ablehnen



Zwischen zwei Anrufen wechseln



Bluetooth Kopplung

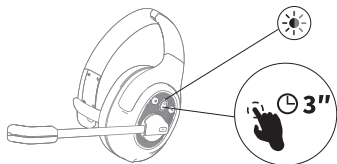

1. Schalten Sie das EKSAtelcom H1 Pro ein, bis die Bluetooth-Anzeige abwechselnd rot und blau blinkt, was anzeigt, dass sich das Headset im Pairing-Modus befindet.

2. Schalten Sie das Bluetooth Ihres Geräts ein, aktivieren Sie die Suchfunktion und wählen Sie "EKSA-H1 Pro". Nach dem Pairing blinkt die Bluetooth-Anzeige langsam in blauem Licht mit der Sprachansage **"your headset is connected"**, was eine erfolgreiche Verbindung bestätigt.

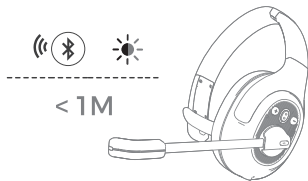
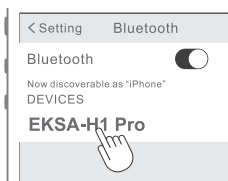

Anmerkung:

1. Halten Sie den Abstand zwischen dem EKSAtelcom H1 Pro und Ihrem Gerät innerhalb von 1 Meter.
2. Falls erforderlich, ist der Pin-Code zum Abschließen der Kopplung "0000".
3. Wenn im Pairing-Status innerhalb von 10 Minuten keine Verbindung hergestellt werden kann, schaltet sich das Headset automatisch aus.
4. Wenn das Headset wieder eingeschaltet wird, verbindet es sich automatisch mit dem zuletzt verbundenen Gerät.
5. Bei der Bluetooth Verbindung mit PC können Kompatibilitätsprobleme auftreten. Am besten mit einem Adapter (nicht enthalten).



3. Um eine Verbindung mit einem neuen Gerät herzustellen, schalten Sie das Bluetooth des aktuell gekoppelten Geräts aus und befolgen Sie die oben genannten Schritte, um eine erfolgreiche Verbindung mit einem neuen Gerät herzustellen.

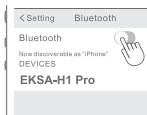

Gerät A

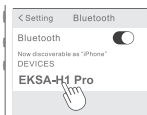

Gerät B





Duale Kopplung

1. Nachdem Sie das EKSAtelecom H1 Pro erfolgreich mit Gerät A verbunden haben, schalten Sie das Bluetooth von Gerät A aus. Die Bluetooth-Anzeige des Headsets blinkt abwechselnd rot und blau, um den Kopplungsmodus anzuzeigen.

Gerät A



2. Schalten Sie das Bluetooth von Gerät B ein, aktivieren Sie den Suchmodus und stellen Sie eine Verbindung zu "EKSA-H1 Pro" her.



Gerät B

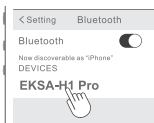

Gerät B



3. Schalten Sie das Bluetooth von Gerät A ein, um sich mit "EKSA-H1 Pro" zu verbinden. Dadurch werden beide Geräte A und B gleichzeitig mit "EKSA-H1 Pro" verbunden.

Gerät A





Zurücksetzen

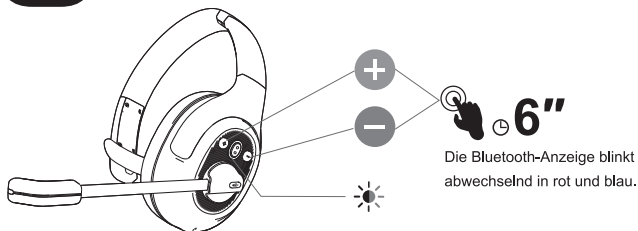

Wenn sich das EKSAtelecom H1 Pro im Verbindungs-/Paarungsmodus befindet, halten Sie die Tasten "Lautstärke +" und "Lautstärke -" gleichzeitig 6 Sekunden lang gedrückt, bis die LED rot und blau leuchtet, um anzuzeigen, dass die Paarungsinformationen gelöscht wurden.



Aufladen

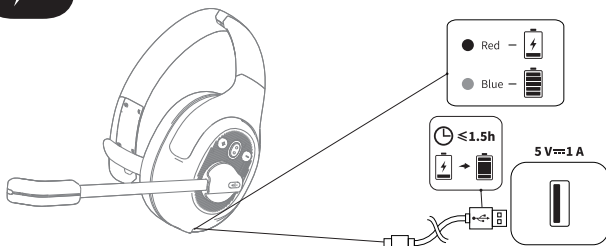

1. Wenn der Akku weniger als 10 % beträgt, gibt das Headset alle 3 Sekunden die Sprachansage **"battery low"** aus. Bitte laden Sie es so bald wie möglich auf.
2. Wenn das EKSAtelecom H1 Pro nicht benutzt wird, laden Sie es bitte mindestens einmal alle 2 Monate auf.
3. Bitte verwenden Sie das Original-Ladekabel zum Aufladen. Die Ladespannung darf 5 V nicht überschreiten.



Lista de Empaque

- ① Audífonos inalámbricos EKSAtelecom H1 Pro
- ② Cable de carga Tipo-C
- ③ Bolsa de transporte
- ④ Manual de usuario
- ⑤ Almohadillas para orejas de reemplazo

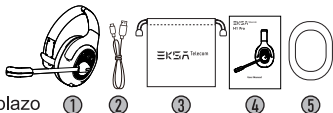

Especificaciones



Versión de Bluetooth: 5.0

Rango inalámbrico efectivo: 30 m / 99 ft

(Máx.50 metros sin obstáculos)



Tiempo de música: ≈57 horas (volumen al 70 %)

Tiempo de conversación: ≈30 horas (volumen al 70 %)

Tiempo de carga: ≈1,5 horas



Diámetro de bocina: 40 mm

Impedancia: $32 \Omega \pm 15 \%$

Sensibilidad: 114 ± 3 dB

Frecuencia de respuesta: 20 Hz - 20 kHz



Tamaño: 2,7 mm * 1,85 mm

Sensibilidad: -25 ± 1 dB

Frecuencia de respuesta: 100 Hz - 10 kHz

Impedancia: 2,2 k Ω







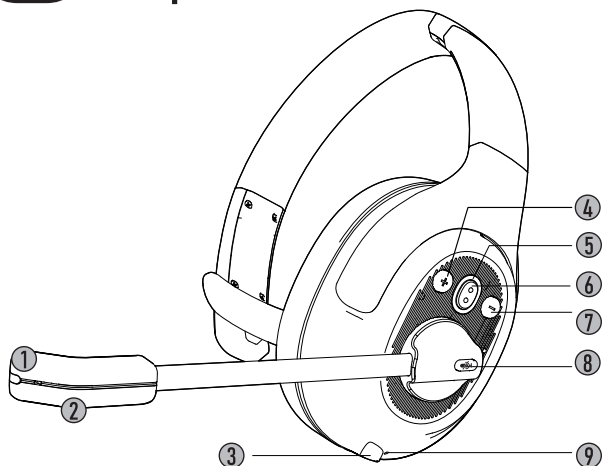

Patrón de polaridad: Omnidireccional

Micrófono: Tecnología de VoicePure EKSAtelecom



Descripción general del producto



- ①  Indicador de llamada
- ②  Tecnología de VoicePure EKS telecom
- ③  Puerto de carga Tipo-C
- ④  Volumen +
- ⑤  Indicador Bluetooth
- ⑥  Botón multifunción (BMF)
- ⑦  Volumen -
- ⑧  Botón para silenciar micrófono
- ⑨  • Indicador de carga



Guía de operación



Botón multifunción:



Presiona por 3 segundos: Auricular encendido/apagado



Click: Inicio/Pausa



Siri



Triple click: Asistente de voz/Siri



Botón de volumen:



Click: Volumen + / -



Presiona por 2 segundos para canción siguiente/previa



Botón para silenciar micrófono:



Click: Micrófono encendido/apagado



Funciones de llamada

Manejo de llamada:

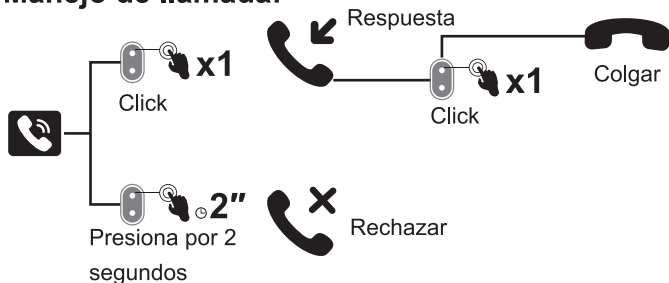

Volver a marcar:

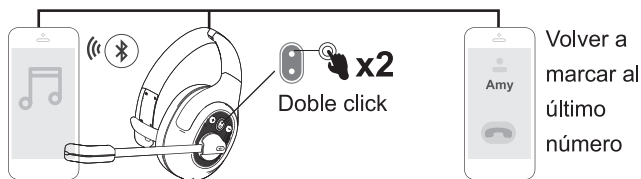

Comutación de audio:

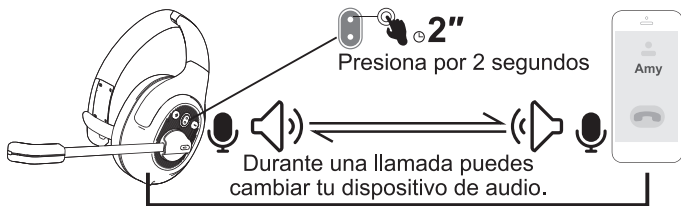



Funciones de llamada



Llamada en tres vías:

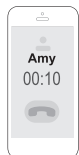

Nueva llamada

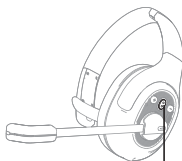

Enciende el teléfono



Click



Responde una nueva llamada y cuelga la llamada actual



Doble click

Modo de llamada en tres vías



Responde una nueva llamada | Mantén la llamada actual
Durante una llamada en tres vías



Presiona por 2 segundos



Mantén la llamada actual y rechaza una nueva llamada



Doble click



Cambia entre dos llamadas



Emparejamiento Bluetooth

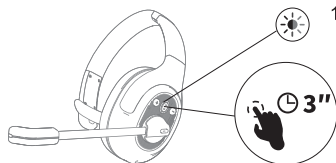

1. Enciende tu EKSAtelcom H1 Pro, hasta que su indicador Bluetooth parpadee alternando entre rojo y azul, indicando que los audífonos están en modo de emparejamiento.

2. Enciende tu dispositivo Bluetooth, activa la función de búsqueda, y selecciona "EKSA-H1 Pro". Después del emparejamiento, el indicador de Bluetooth parpadeará lentamente en azul con un mensaje de voz "your headset is connected", confirmando una conexión exitosa.

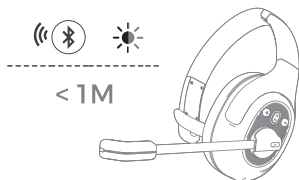
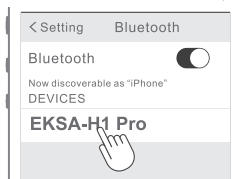

Nota:

1. Mantenga la distancia entre el EKSAtelcom H1 Pro y su dispositivo dentro de 1 metro.
2. De ser necesario, el código pin para completar el emparejamiento es "0000".
3. Cuando se encuentre en proceso de emparejamiento, si la conexión no puede establecerse dentro de 10 minutos, los auriculares automáticamente se apagarán.
4. Cuando los audífonos estén encendidos de nuevo, se conectarán al último dispositivo emparejado, de manera automática.
5. Puede haber problemas de compatibilidad con la conexión a una computadora a través de Bluetooth. Lo mejor es usar un adaptador para conectar (no incluido).

3. Para conectar un nuevo dispositivo, apaga el Bluetooth del dispositivo que actualmente está emparejado y sigue los pasos anteriores para conectar exitosamente a un nuevo dispositivo.

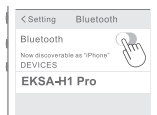

dispositivo A

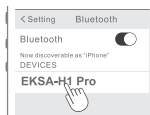

dispositivo B





Emparejamiento dual

1. Después de conectar exitosamente el EKSAtelecom H1 Pro al dispositivo A, apaga el Bluetooth del dispositivo A. El indicador Bluetooth de los audífonos parpadeará entre rojo y azul para indicar que se encuentra en modo de emparejamiento.

dispositivo A

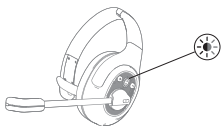

2. Enciende el dispositivo Bluetooth B, activa el modo de búsqueda, y conéctate a "EKSA-H1 Pro".

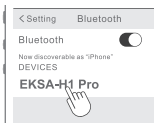

dispositivo B

dispositivo B

3. Enciende el dispositivo Bluetooth A para conectar con "EKSA-H1 Pro". Esto colocará a ambos dispositivos (A y B) en una conexión simultánea con "EKSA-H1 Pro".

dispositivo A





Reiniciar

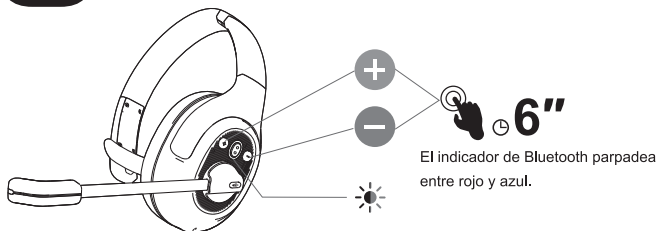

Cuando EKSatelecom H1 Pro esté conectado/modo de emparejamiento, presiona y sostén los botones "volumen +" y "volumen -" de manera simultánea por 6 segundos hasta que las luces LED enciendan en rojo y azul, indicando que la información de emparejamiento está borrada.



Carga

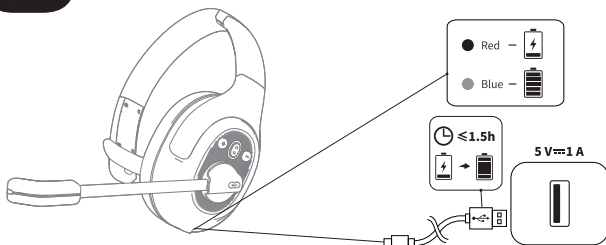

1. Cuando la batería cuente con menos del 10 %, los audífonos darán el mensaje de voz **"battery low"** cada 3 minutos. Por favor, cárgalos lo más pronto posible.
2. Cuando EKSatelecom H1 Pro no sea usado, por favor cárgalo al menos una vez cada dos meses.
3. Por favor usa el cable original para la carga. El voltaje no debe exceder los 5 V.



Lista d'imballaggio

- ① EKSAtelecom H1 Pro Cuffie senza Fili
- ② Cavo di Ricarica di Type-C
- ③ Custodia per Trasporto
- ④ Manuale per Utente
- ⑤ Cuscinetto auricolare di ricambio

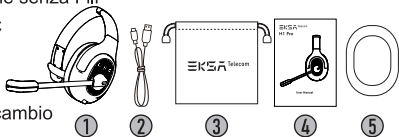

Specificazioni



Versione Bluetooth: 5.0

Portata Wireless Effettiva: 30 m / 99 feet
(Max. 50 metri senza ostacoli)



Tempo di Musica: ≈57 ore (70 % volume)

Tempo di Conversazione: ≈30 ore (70 % volume)

Tempo di Ricarica: ≈1,5 ore



Diametro Altoparlante: 40 mm

Impedenza: $32 \Omega \pm 15 \%$

Sensibilità: 114 ± 3 dB

Risposta in Frequenza: 20 Hz - 20 kHz



Dimensioni: 2,7 mm * 1,85 mm

Sensibilità: -25 ± 1 dB

Risposta in Frequenza: 100 Hz - 10 kHz

Impedenza: 2,2 k Ω

Schema Polare: Omnidirezionale

Microfono: EKSAtelecom VoicePure Tecnologia



Panoramica del Prodotto

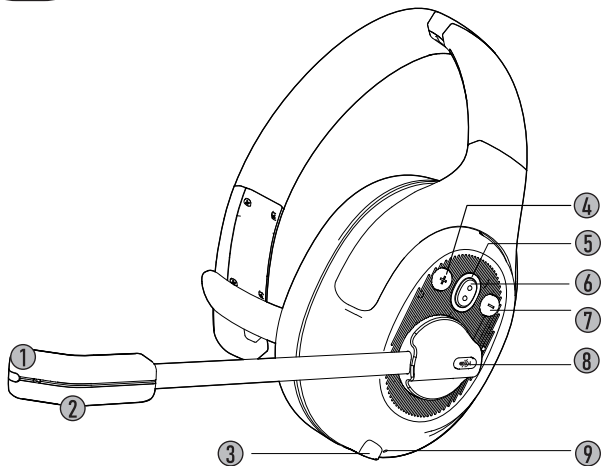

- ① Indicatore di chiamata
- ② EKSAtelecom VoicePure Tecnologia
- ③ Porta di Ricarica di Type-C
- ④ Volume +
- ⑤ Indicatore Bluetooth
- ⑥ Pulsante Multifunzione (MFB)
- ⑦ Volume -
- ⑧ Pulsante Muto Microfono
- ⑨ Indicatore di Ricarica



Guida d'Operazione



Pulsante Multifunzione:



Premere per 3 secondi: Cuffia accesa/spenta



Click: Play/Pause



Siri



Triplo Click: Assistente Vocale/Siri



Pulsante del Volume:



Click: Volume + / -



Premere per 2 secondi alla traccia successiva/precedente



Pulsante Muto Microfono:



Click: Microfono acceso/spento



Funzioni di Chiamata

Gestione di Chiamata:

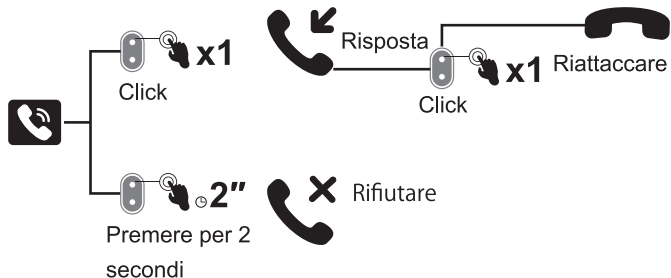

Ricomposizione:

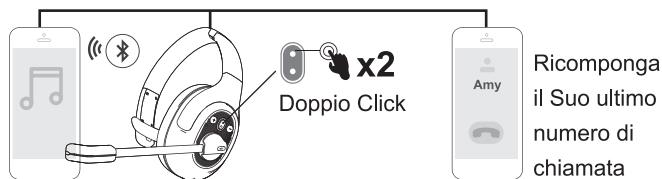

Commutazione Audio:





Funzioni di Chiamata



Chiamate a Tre Vie:

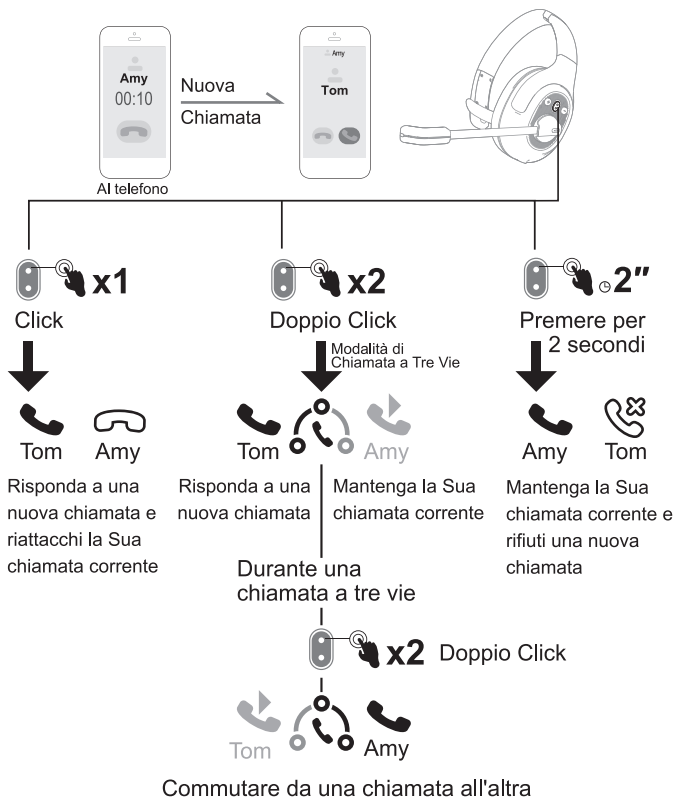



Accoppiamento Bluetooth

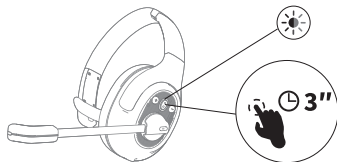

1. Accendere EKSAtelecom H1 Pro, finché il suo indicatore Bluetooth non lampeggia alternativamente in rosso e blu, indicando che l'auricolare è in modalità di accoppiamento.

2. Attivi il Bluetooth del Suo dispositivo, attivi la funzione di ricerca e seleziona "EKSA-H1 Pro". Dopo l'accoppiamento, l'indicatore Bluetooth lampeggia lentamente in luce blu con un messaggio vocale **"your headset is connected"**, confermando una connessione riuscita.

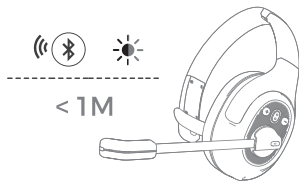
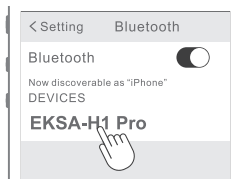

Nota:

1. Mantiene la distanza tra EKSAtelecom H1 Pro e il tuo dispositivo entro 1 metro.
2. Se necessario, il codice pin per completare l'accoppiamento è "0000".
3. Durante lo stato di accoppiamento, se non è possibile stabilire una connessione entro 10 minuti, l'auricolare si spegnerà automaticamente.
4. Quando l'auricolare viene riacceso, si collegherà automaticamente all'ultimo dispositivo connesso.
5. Potrebbero esserci problemi di compatibilità con la connessione a un computer tramite Bluetooth, È meglio utilizzare un adattatore per la connessione (non incluso).

3. Per connettersi a un nuovo dispositivo, disattivi il Bluetooth del dispositivo attualmente accoppiato e segua i passaggi precedenti per connettersi correttamente a un nuovo dispositivo.

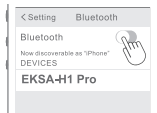

dispositivo A

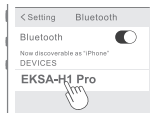

dispositivo A





Doppio Accoppiamento

1. Dopo aver collegato correttamente EKSAtelecom H1 Pro al dispositivo A, spegna il Bluetooth del dispositivo A. L'indicatore Bluetooth dell'auricolare lampeggia alternativamente in rosso e blu per indicare la modalità di accoppiamento.

dispositivo A



2. Attivi il Bluetooth del dispositivo B, attivi la modalità di ricerca, e connessa a "EKSA-H1 Pro".

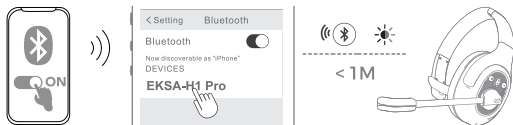

dispositivo B

dispositivo B

3. Attivi il Bluetooth del dispositivo A per connettersi con "EKSA-H1 Pro". Ciò mette entrambi i dispositivi A e B in una connessione simultanea con "EKSA-H1 Pro".

dispositivo A

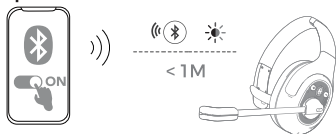



Ripristinare

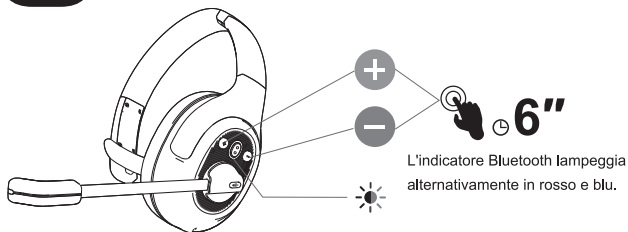

Quando EKSatelecom H1 Pro è in modalità di connessione/accoppiamento, tenga premuti contemporaneamente i pulsanti "volume +" e "volume -" per 6 secondi finché il LED non si accende in rosso e blu, indicando che le informazioni di accoppiamento sono state cancellate.



Ricarica

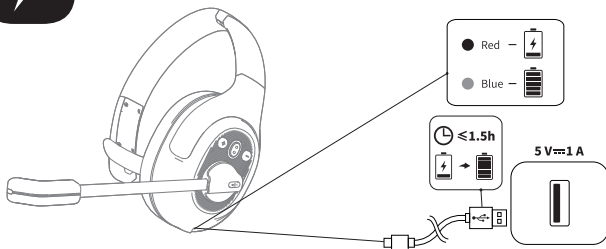

1. Quando la batteria è inferiore al 10 %, l'auricolare emetterà un messaggio vocale "**battery low**" ogni 3 minuti. Si prega di caricarlo il più presto possibile.
2. Quando EKSatelecom H1 Pro non è in uso, si prega di caricarlo almeno una volta ogni 2 mesi.
3. Si prega di utilizzare il cavo di ricarica originale per la ricarica. La tensione di carica non può superare i 5 V.

Limited Warranty / 保証 / Garantie Limitée / Eingeschränkte Garantie / Garantía Limitada / Garanzia Limitata

Our friendly customer service team is ready and waiting to help. Feel free to contact us:

私たちのカスタマーサービスチームはいつでもお手伝いします。連絡先は次のとおり:

Notre amicale équipe de service à la clientèle est prête et attend de vous aider. N'hésitez pas à nous contacter :

Unser freundliches Kundenservice-Team ist bereit, Ihnen zu bedienen. So können Sie uns kontaktieren:

Nuestro amable equipo de servicio al cliente está listo y esperando para ayudarlo. Bienvenido a contactarnos:

Il nostro cordiale team di assistenza clienti è pronto e in attesa di aiutare. Non esitate a contattarci:

 GLOBAL: +852 6940 4955 (Mon to Fri 9:00 am-6:30 pm, UTC +8 HKT)
INDIA: +91-7676831995 (9:30 to 17:30 active time, IST, Mon to Fri)

 GLOBAL: info@eksatelecom.com
INDIA: support@eksatelecom.co.in

 www.eksatelecom.com/pages/warranty

Manufacturer: YI ZHAO (SHENZHEN) CO., LIMITED

Add.: 6th Floor, T3 Creative Building, Shenzhen Colorful Huiwei Cultural and Creative Expo City, No.5010 Baoan Avenue, Caowei Community, Hangcheng Street, Baoan District, Shenzhen City, Guangdong Province, China



C&E Connection E-Commerce (DE) GmbH
Add.: Zum Linnegraben 20, 65933, Frankfurt am Main, Germany
Tel.: +4906927246648
Email: info@ce-connection.de



APEX CE SPECIALISTS LIMITED
Add.: 89 Princess Street, Manchester, M1 4HT, UK
Tel.: +441616371080
Email: info@apex-ce.com

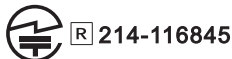

FCC ID: 2A25A-H1

Made in China

Be Heard Anywhere