

Introduction and Features

The AP4-FD31 provides a 6-channel pre-amp output for use with aftermarket audio equipment. Using the digital A2B audio data in conjunction with CAN data, the AP4-FD31 delivers a variable 5v RMS pre-amp output with fading, balance, equalization, and level control capabilities. The module also retains audio from other vehicle features such as factory navigation prompts, safety chimes, Bluetooth and voice activation. A data bus controlled remote amplifier turn on wire is also provided by the AP4-FD31. The module also provides a variable 2-channel fiber optic digital audio output (TOSLINK).

Important Notes

1. This interface is only compatible in vehicles equipped with an A2B data bus controlled premium sound system. To verify compatibility, look for a B&O badge on the door speakers or dash speakers.
2. The AP4 interface installs at the factory amplifier location. Included T-Harness installs behind radio to access factory speaker wiring not available at factory amplifier.
3. The factory amplifier will be disconnected and will no longer power the vehicle speakers. An aftermarket amplifier must be added to power the vehicle's speakers. For example, you cannot only add a subwoofer, as the factory speakers that were connected to the factory amplifier will no longer function.
4. On most Ford models, some of the vehicle speakers will be connected to the radio module in addition to the external amplifier. These speakers will also stop working when the factory amplifier is disconnected and will need to be powered by an aftermarket amplifier. See Speaker Connections on Page 3 for vehicle specific speaker information.
5. The chime volume and minimum volume levels are set to 50% by default. If this level is adequate, no additional adjustment is required. Please refer to the Setup and Configuration section on page 9 for more details.
6. The level control knob must be connected in order to manually adjust the chime volume and minimum volume settings.
7. The remote output is rated at 2A of current. If more current is needed, an external relay must be used.
8. Channels 5 and 6 are non-fading outputs. The output level of channels 5 and 6 can be controlled using the supplied level control knob.
9. No adjustments can be made manually using the programming button, or the factory SWC, when the module is connected to a PC.

Module Layout

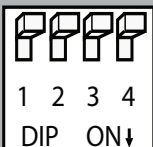
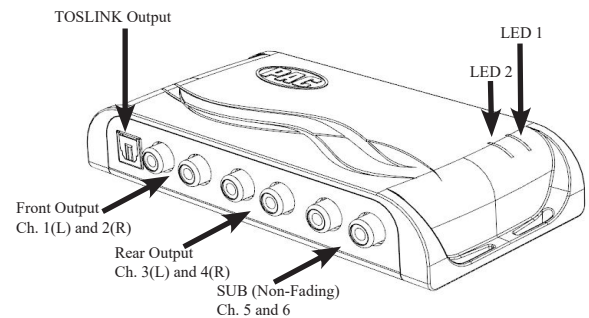
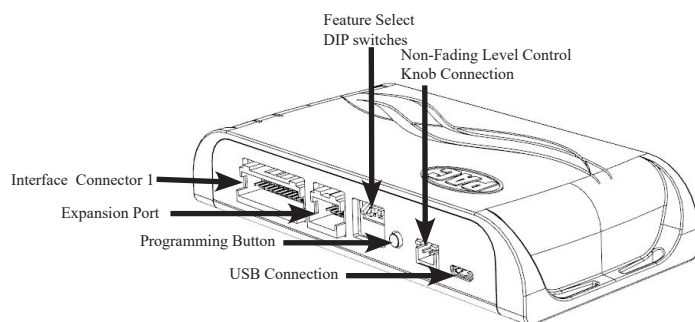

Set DIP switches to the ON position to activate the corresponding features.
Set DIP switches to the OFF position for any features that are not desired.



Two Channel Mode	5v / 4v Preout	Not Used	Vehicle Select
1	2	3	4

Wiring Connection Chart

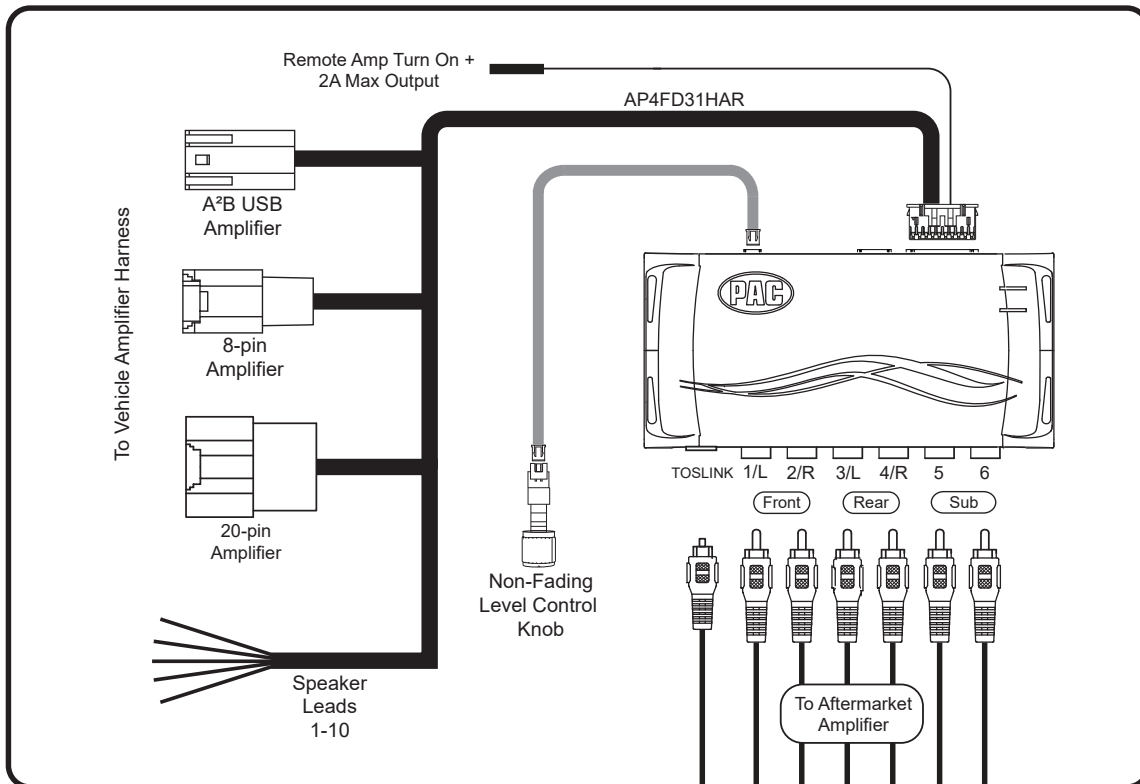

Installation

1. Access the factory amplifier (Audio Digital Sound Processing Module). Amplifier locations are listed starting on Page 3.
2. Disconnect the 20-pin, 8-pin and A2B USB connectors from the amplifier. The amplifier can be removed or left in the vehicle.
3. Plug the 20-pin, 8-pin and A2B USB cables into the matching connectors on the AmpPRO (AP4FD31HAR) harness.
4. Before connecting the interface, set any feature DIP switches that apply to the install:
 - a. DIP switch 1 is used for two channel mode. In this mode, all outputs will be non-fading and all chimes are diverted through channels 1 & 2 and TOSLINK.
 - b. Set DIP switch 2 on (down) to lower the RCA output voltage to 4v. Leave DIP switch 2 off (up) to keep the RCA output voltage at 5v. See troubleshooting section on Page 11 for more details.
 - c. DIP switch 3 is not used and should remain off (up).
 - d. Set DIP switch 4 to on (down) position if installing interface in a Mach-E. For all other vehicle models, DIP switch 4 should be off (up).
5. Connect the AmpPRO harness to the AmpPRO Interface Connector 1.
6. Connect the level control knob cable to the interface.
7. Connect the signal cables (RCA/TOSLINK) and remote input from the aftermarket amplifier.

NOTE! The aftermarket amplifier must have a very solid ground and the amplifier power/ground connections should be made before connecting the RCA's or Remote Turn On to the AP4-FD31! On aluminum framed vehicles, it is recommended to ground directly to the battery.

Speaker Connections

If using the factory speaker wires to connect to the aftermarket amplifier, they will be located in two locations, at the 20-pin plug at the Digital Sound Processing Module (Amplifier) and either a 32-pin or 24-pin plug at the Audio Control Module (Radio). Adapter plugs are provided for all speaker wire connections.

Because the factory speaker wire pin locations, colors and plug style vary from model to model, reference the charts below and use a tone generator for speaker locations and polarity. Please note that most vehicles will not follow the "standard" speaker wire colors and polarity. For example the right front positive speaker lead may connect to the left rear negative (GRN/BLK) lead on the adapter plug.

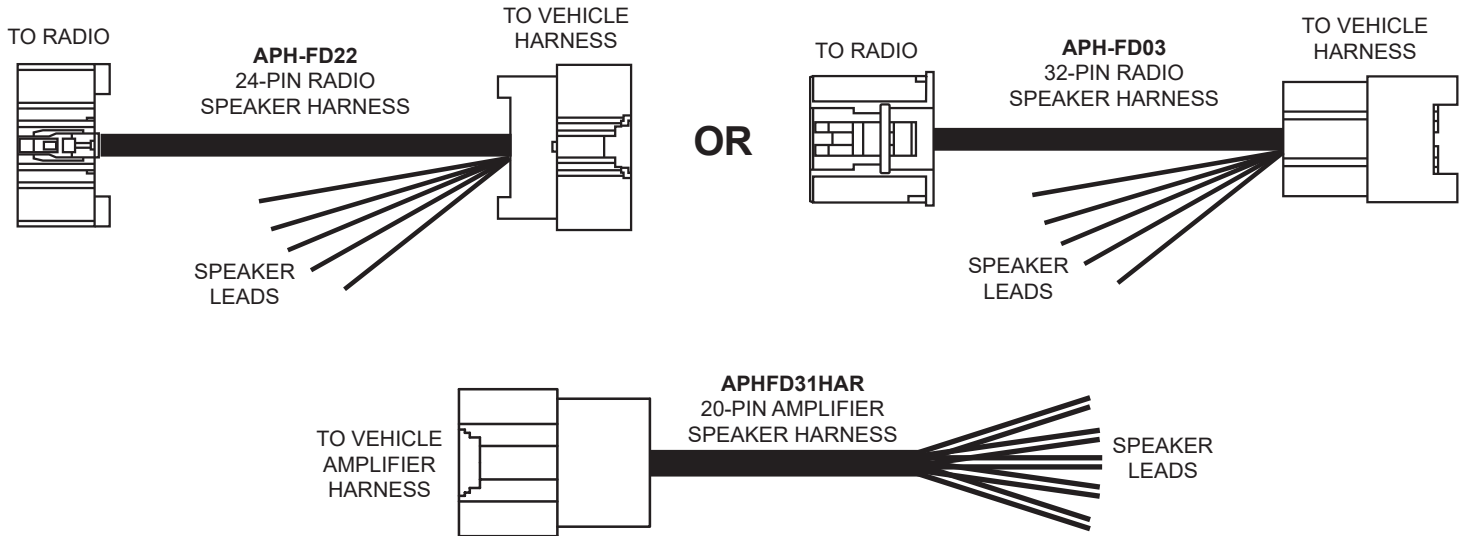

For additional vehicle applications and the latest speaker wiring information, visit the AP4-FD31 product page on PACaudio.com



Ford Bronco (10 Speaker) 2021 | Amplifier Location: RH cargo area behind trim panel

20 Pin Plug at AMPLIFIER (DSP) (AP4FD31HAR)		
LEADS	PAC COLOR	POSITION/POLARITY
Speaker 1	WHT	LF KICK / +
Speaker 1	WHT/BLK	LF KICK / -
Speaker 2	GRY	RF KICK / +
Speaker 2	GRY/BLK	RF KICK / -
Speaker 3	GRN	LF DASH / +
Speaker 3	GRN/BLK	LF DASH / -
Speaker 4	VIO	RF DASH / +
Speaker 4	VIO/BLK	RF DASH / -
Speaker 5	RED	SUB2 / +
Speaker 5	RED/BLK	SUB2 / -
Speaker 6	BLU	SUB1 / +
Speaker 6	BLU/BLK	SUB1 / -
Speaker 7	BRN	
Speaker 7	BRN/BLK	

32 Pin Plug at RADIO (ACM) (APH-FD03)		
LEADS	PAC COLOR	POSITION/POLARITY
Speaker 1	WHT	LR POD / +
Speaker 1	WHT/BLK	LR POD / -
Speaker 2	GRY	CENTER / +
Speaker 2	GRY/BLK	CENTER / -
Speaker 3	GRN	
Speaker 3	GRN/BLK	
Speaker 4	VIO	RR POD / +
Speaker 4	VIO/BLK	RR POD / -
Speaker 5	ORG	
Speaker 5	ORG/BLK	
NOTES:		

Ford Bronco Sport (10 Speaker) 2021 | Amplifier Location: LH cargo area behind trim panel

20 Pin Plug at AMPLIFIER (DSP) (AP4FD31HAR)		
LEADS	PAC COLOR	POSITION/POLARITY
Speaker 1	WHT	LF DOOR / +
Speaker 1	WHT/BLK	LF DOOR / -
Speaker 2	GRY	RF DOOR / +
Speaker 2	GRY/BLK	RF DOOR / -
Speaker 3	GRN	LR DOOR / +
Speaker 3	GRN/BLK	LR DOOR / -
Speaker 4	VIO	RR DOOR / +
Speaker 4	VIO/BLK	RR DOOR / -
Speaker 5	RED	
Speaker 5	RED/BLK	
Speaker 6	BLU	SUB1 / +
Speaker 6	BLU/BLK	SUB1 / -
Speaker 7	BRN	
Speaker 7	BRN/BLK	
Speaker 8	WHT/BLU	
Speaker 8	WHT/RED	
Speaker 9	LT GRN	
Speaker 9	LT GRN/BLK	

32 Pin Plug at RADIO (ACM) (APH-FD03)		
LEADS	PAC COLOR	POSITION/POLARITY
Speaker 1	WHT	CENTER / +
Speaker 1	WHT/BLK	CENTER / -
Speaker 2	GRY	LH DASH / -
Speaker 2	GRY/BLK	LH DASH / +
Speaker 3	GRN	RH DASH / -
Speaker 3	GRN/BLK	RH DASH / +
Speaker 4	VIO	
Speaker 4	VIO/BLK	
Speaker 5	ORG	
Speaker 5	ORG/BLK	

NOTES:

Ford F-150 (8 Speaker) 2018-2020 | Amplifier Location: Behind LH rear seat back

20 Pin Plug at AMPLIFIER (DSP) (AP4FD31HAR)		
LEADS	PAC COLOR	POSITION/POLARITY
Speaker 1	WHT	LF DOOR / +
Speaker 1	WHT/BLK	LF DOOR / -
Speaker 2	GRY	RF DOOR / +
Speaker 2	GRY/BLK	RF DOOR / -
Speaker 3	GRN	LR DOOR / +
Speaker 3	GRN/BLK	LR DOOR / -
Speaker 4	VIO	RR DOOR / +
Speaker 4	VIO/BLK	RR DOOR / -
Speaker 5	RED	SUB2 / +
Speaker 5	RED/BLK	SUB2 / -
Speaker 6	BLU	SUB1 / +
Speaker 6	BLU/BLK	SUB1 / -
Speaker 7	BRN	CENTER / +
Speaker 7	BRN/BLK	CENTER / -
Speaker 8	WHT/BLU	
Speaker 8	WHT/RED	
Speaker 9	LT GRN	
Speaker 9	LT GRN/BLK	

24 Pin Plug at RADIO (ACM) (APH-FD22)		
LEADS	PAC COLOR	POSITION/POLARITY
Speaker 1	WHT	LF TWEET / +
Speaker 1	WHT/BLK	LF TWEET / -
Speaker 2	GRY	RF TWEET / +
Speaker 2	GRY/BLK	RF TWEET / -
Speaker 3	GRN	
Speaker 3	GRN/BLK	
Speaker 4	VIO	
Speaker 4	VIO/BLK	
Speaker 5	ORG	
Speaker 5	ORG/BLK	

NOTES:



Ford F-150 (8 Speaker) 2021-2022 | Amplifier Location: Behind LH rear seat back

20 Pin Plug at AMPLIFIER (DSP) (AP4FD31HAR)		
LEADS	PAC COLOR	POSITION/POLARITY
Speaker 1	WHT	LF DOOR / +
Speaker 1	WHT/BLK	LF DOOR / -
Speaker 2	GRY	RF DOOR / +
Speaker 2	GRY/BLK	RF DOOR / -
Speaker 3	GRN	LR DOOR / +
Speaker 3	GRN/BLK	LR DOOR / -
Speaker 4	VIO	RR DOOR / +
Speaker 4	VIO/BLK	RR DOOR / -
Speaker 5	RED	CENTER / +
Speaker 5	RED/BLK	CENTER / -
Speaker 6	BLU	SUB1 / +
Speaker 6	BLU/BLK	SUB1 / -
Speaker 7	BRN	
Speaker 7	BRN/BLK	
Speaker 8	WHT/BLU	
Speaker 8	WHT/RED	

32 Pin Plug at RADIO (ACM) (APH-FD03)		
LEADS	PAC COLOR	POSITION/POLARITY
Speaker 1	WHT	
Speaker 1	WHT/BLK	
Speaker 2	GRY	LF PILLAR / +
Speaker 2	GRY/BLK	LF PILLAR / -
Speaker 3	GRN	RF PILLAR / +
Speaker 3	GRN/BLK	RF PILLAR / -
Speaker 4	VIO	
Speaker 4	VIO/BLK	
Speaker 5	ORG	
Speaker 5	ORG/BLK	
NOTES:		

Ford F-150 (18 Speaker) 2021-2022 | Amplifier Location: Behind LH rear seat back

20 Pin Plug at AMPLIFIER (DSP) (AP4FD31HAR)		
LEADS	PAC COLOR	POSITION/POLARITY
Speaker 1	WHT	LF DOOR / +
Speaker 1	WHT/BLK	LF DOOR / -
Speaker 2	GRY	LH DASH / +
Speaker 2	GRY/BLK	LH DASH / -
Speaker 3	GRN	LF OVERHEAD / +
Speaker 3	GRN/BLK	LF OVERHEAD / -
Speaker 4	VIO	LH HEADREST / +
Speaker 4	VIO/BLK	LH HEADREST / -
Speaker 5	RED	RF OVERHEAD / +
Speaker 5	RED/BLK	RF OVERHEAD / -
Speaker 6	BLU	SUB1 / +
Speaker 6	BLU/BLK	SUB1 / -
Speaker 7	BRN	RF DOOR / +
Speaker 7	BRN/BLK	RF DOOR / -
Speaker 8	WHT/BLU	RH DASH / -
Speaker 8	WHT/RED	RH DASH / +
Speaker 9	LT GRN	CENTER / +
Speaker 9	LT GRN/BLK	CENTER / -
Speaker 10	ORG	RH HEADREST / +
Speaker 10	ORG/BLK	RH HEADREST / -

32 Pin Plug at RADIO (ACM) (APH-FD03)		
LEADS	PAC COLOR	POSITION/POLARITY
Speaker 1	WHT	LR DOOR / +
Speaker 1	WHT/BLK	LR DOOR / -
Speaker 2	GRY	LF PILLAR / +
Speaker 2	GRY/BLK	LF PILLAR / -
Speaker 3	GRN	RF PILLAR / +
Speaker 3	GRN/BLK	RF PILLAR / -
Speaker 4	VIO	RR DOOR / +
Speaker 4	VIO/BLK	RR DOOR / -
Speaker 5	ORG	
Speaker 5	ORG/BLK	
NOTES:		



Setup and Configuration

1. Once all connections have been made and all factory harnesses are reconnected, close all the doors, lock the car using the factory keyfob, and let the vehicle sit for 10 minutes with the keyfob out of range. This will ensure that the vehicle data-bus goes to sleep and the AmpPRO will function as intended.
2. Turn the ignition on. LED 1 on the interface will turn on and the +12v remote output will turn on.
3. Set the amp gain(s) to the desired level. We recommend using an oscilloscope and test tones to set the amp gain(s). Please refer to the MECF Advanced study guide if you are unfamiliar with this process.
4. Check volume, balance, fade and EQ settings.
5. If you would like to adjust the chime volume or minimum volume, do so using one of the methods outlined below. If you are happy with the default levels, no adjustments are necessary.

Manually Setting the Chime Volume

You can manually set the level of the factory chime using either the programming button on the side of the interface, or the factory SWC. If you would like to set the chime volume using the PC app please proceed to the AmpPRO App section.

PLEASE NOTE: Level control knob must be connected to module for either of the following methods.

Setting the chime volume using the programming button

1. Start with the level control knob turned all the way down (counter-clockwise), the vehicle running and the driver's door closed.
2. Press the programming button on the side of the interface.
3. LED 1 will turn green and there will be three beeps.
4. Open the driver's door and the chimes will begin continuously sounding for seven seconds.
5. Turn the level control knob clockwise until the desired chime level is reached.
6. You can now either press the programming button twice or wait ten seconds to exit the settings.

Setting the chime volume using the factory SWC

1. Start with the level control knob turned all the way down, the vehicle running and the driver's door closed.
2. Press and hold the track down button on the factory SWC for approximately ten seconds. **PLEASE NOTE:** The radio will respond to the SWC commands during this process, this is normal and has no effect on the AP4 operation.
3. LED 1 will turn green and there will be three beeps.
4. Open the driver's door and the chimes will begin continuously sounding for seven seconds.
5. Turn the level control knob clockwise until the desired chime level is reached.
6. You can now either press the programming button twice or wait ten seconds to exit the settings.

Manually Setting the Minimum Volume

If the minimum volume of the radio (factory radio volume level 1) is too loud, you can manually set the level of the minimum volume using either the programming button on the side of the interface or the factory SWC. If you would like to set the minimum volume using the AmpPRO app, please proceed to the AmpPRO App section.

Setting the minimum volume using the programming button

1. Start with the level control knob turned all the way down (counter-clockwise).
2. Set the amp gains to the desired level.
3. Set the volume on the factory radio to 1.
4. Press the programming button on the side of the interface twice.
5. LED 1 will turn amber and there will be two beeps.
6. Turn the level control knob clockwise until the desired minimum volume level is reached.
7. You can now either press the programming button once or wait ten seconds to exit the settings.

Setting the minimum volume using the factory SWC

1. Start with the level control knob turned all the way down (counter-clockwise).
2. Set the amp gains to the desired level.
3. Set the volume on the factory radio to 1.
4. Press and hold the track up button on the factory SWC for approximately ten seconds. **PLEASE NOTE:** The radio will respond to the SWC commands during this process, this is normal and has no effect on the AP4 operation.
5. LED 1 will turn amber and there will be two beeps.
6. Turn the level control knob clockwise until the desired minimum volume level is reached.
7. You can now either press the programming button once or wait ten seconds to exit the settings.



Use of the AmpPRO App allows you to do the following:

- Configure User Interface Options such as:
 - Minimum Volume Level
 - Chime Volume Level
 - Enable / Disable factory EQ
 - Bass / Mid / Treble boost frequencies and Q factor
- Update Product Firmware
- Read Firmware / Hardware Versions

You can download the Amp PRO app at :
<http://aampglobal.com/appdownloads>

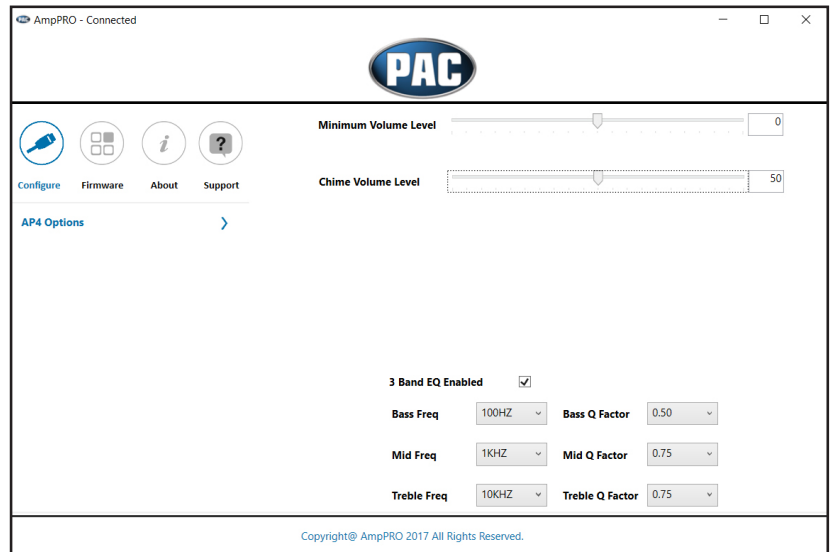

PLEASE NOTE: These settings can be adjusted with the module installed in the vehicle, or on the bench. However, it is recommended to make the adjustments with the module installed, and the factory radio on, so that the changes can be heard.

Minimum Volume Level - This allows you to set the minimum volume level of the factory radio (factory radio volume level 1).

Chime Volume Level - This allows you to set the volume of the AP4 chimes (ie: park sensors).

3 Band EQ Enabled - This allows you to enable / disable the 3 band factory EQ.

Bass / Mid / Treble Freq / Q Factor - This allows you to set the center frequency that will be adjusted when setting the 3 band factory EQ, as well as the Q Factor for each frequency. The Q Factor determines how many of the adjacent frequencies will be

Available Frequencies and Q Factors					
Bass Frequency	60HZ	Mid Frequency	500HZ	Treble Frequency	7.5KHZ
	80HZ		1KHZ		10KHZ
	100HZ		1.5KHZ		12.5KHZ
	120HZ		2.5KHZ		15KHZ
Bass Q Factor	0.50	Mid Q Factor	0.75	Treble Q Factor	0.75
	1.00		1.00		1.25
	1.50		1.25		
	2.00		1.50		

AmpPRO App (cont)

Firmware Updates

The AmpPRO app will also allow you to update the interface with new firmware as it becomes available. Please visit www.pac-audio.com or contact our tech support department to see if there is a firmware update for your interface.

Connect the interface to your PC and select "Firmware", then "Update Firmware". Now select "Select File". Finally, browse to the place where you saved the file and select it. This will begin the updating process. Once finished, disconnect the interface from the PC and resume normal operation.

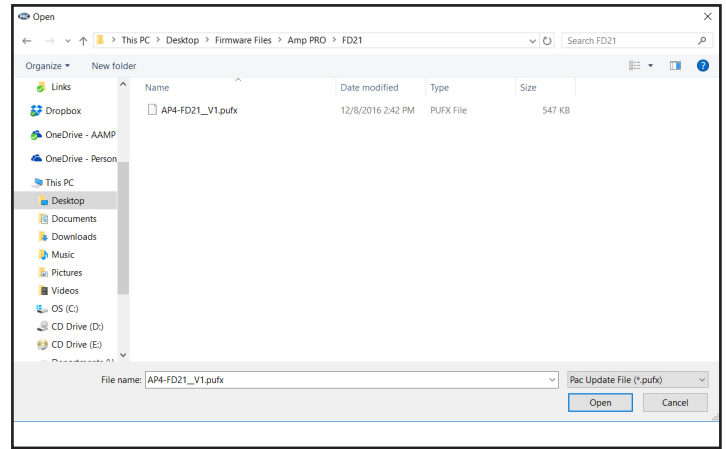
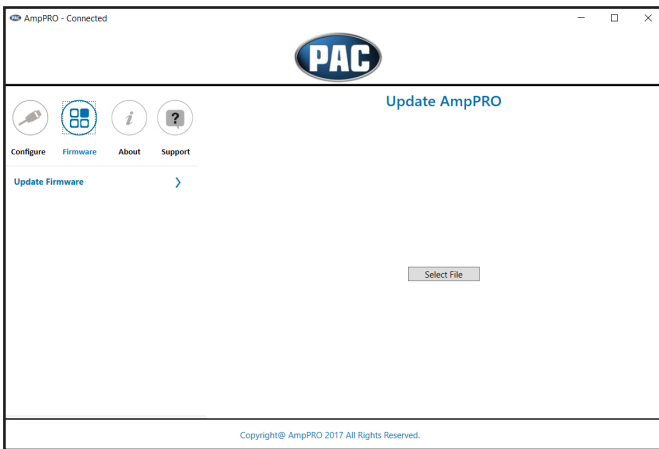

Restoring Factory Settings

You can restore the interface to factory default settings by pressing and holding the programming button on the side of the module until the status LEDs start blinking red. Once the LEDs start blinking red, release the button.

This reset will restore the following settings to their factory defaults:

- Chime volume level
- Minimum volume level
- Enable / Disable factory EQ
- Factory EQ frequency
- Factory EQ Q factor

Troubleshooting

1. No audio - Check to see if LED 1 is illuminated. If not, cycle the ignition off and back on.
2. Hiss at high amp gain - Set feature DIP switch 2 to the on (down) position to lower the output voltage of the AP4 to 4v. If you still hear the hiss, lower your amp gains until the hiss is gone.
3. Low volume setting on radio is too loud - Set minimum volume using process outlined in Setup and Configuration, or using the AmpPRO application.

LED Legend		
	Action/Color	During Normal Operation
LED 1	Solid Red	Module Active
	Solid Amber	Minimum Volume Adjustment Mode
	Rapid Blink Any Color	DSP Activity
LED 2	Blinking Amber	USB Connection Detected
Both LEDs	Alternate Blinking Red	Performing Memory Reset

Technical Support

Email: support@PAC-audio.com

Phone: 727-592-5991

Chat: PAC-Audio.com

Warranty

LIMITED WARRANTY

The quality controls used to manufacture PAC products are designed to ensure your complete satisfaction.

This warranty applies only to the original owner of PAC products purchased from an authorized PAC dealer. It covers PAC products that, upon inspection by authorized PAC personnel, are found to have failed in normal use due to defects in material or workmanship. This warranty does not cover installation expenses.

Attempting to service or modify our products, or operate them outside their recommended usage will render this WARRANTY VOID.

Unless prescribed by law, PAC is not liable for any personal injury, property damage and/or incidental or consequential damages (including water damage) resulting from product malfunctions, defects and/or misuse. PAC is also not liable for any products that are altered or improperly installed.

WARRANTY PERIOD AND PROCESS

Within the first 12 months from date of purchase, subject to the conditions above, PAC will repair or replace product at its sole discretion if it is found to be defective in material or workmanship. Product must be returned to an authorized PAC dealer with PROOF OF PURCHASE.

