



User manual for Spectrum One

This manual provides information on monitor features, setting up and using the monitor, and technical specifications, for the following 27" IPS Spectrum One monitors developed by Dough:

ES07D03, ES07DC9, ES07E30

© Copyright 2023 Dough GmbH

AMD, the AMD Arrow logo, FreeSync™, and Radeon™ are trademarks of Advanced Micro Devices, Inc. NVIDIA®, the NVIDIA® logo, GeForce®, and G-SYNC™ are trademarks and/or registered trademarks of NVIDIA Corporation in the United States and other countries. DisplayPort™, the DisplayPort™ logo, and VESA® are trademarks and/or registered trademarks of the Video Electronics Standards Association in the United States and other countries. HDMI®, the HDMI® Logo, and High-Definition Multimedia Interface are trademarks and/or registered trademarks of HDMI Licensing LLC. USB Type-C® and USB-C® are registered trademarks of USB Implementers Forum. Corning® and Gorilla® Glass are registered trademarks of Corning Inc. Windows is a trademark and/or registered trademark of Microsoft Corporation in the United States and other countries. Other company and product names may be trademarks of the respective companies with which they are associated.

The information contained herein is subject to change without notice. The only warranties for Dough products and services are set forth in the express warranty statements accompanying such products and services. Nothing herein should be construed as constituting an additional warranty. Dough shall not be liable for technical or editorial errors or omissions contained herein.

First Edition: April 2021

About this manual



CAUTION

Indicates there's a hazardous situation that could be dangerous and cause injury or even death. It's important to follow the instructions closely to avoid this risk.



IMPORTANT

Indicates that the information is significant, but not necessarily hazardous. It could relate to the proper functioning of your device or avoiding property damage or data loss.



NOTE

Provides additional information to clarify or supplement important points in the main text. Notes may provide helpful hints for completing a task.



This product incorporates HDMI technology.

Table of contents

| | |
|--|-----------|
| About this manual | 3 |
| Table of contents | 4 |
| Getting started | 8 |
| Important safety information..... | 8 |
| About Spectrum One..... | 9 |
| Front components..... | 10 |
| Rear components..... | 10 |
| Rear components..... | 11 |
| Setting up Spectrum | 12 |
| Installing the Spectrum Stand..... | 12 |
| Removing the Spectrum Stand | 14 |
| Attaching a VESA mount..... | 15 |
| Connecting the power cable..... | 17 |
| Connecting video cables..... | 18 |
| Connecting USB devices | 20 |
| The built-in USB hub..... | 20 |
| Connecting peripheral devices | 21 |
| Connecting to the USB host device(s) | 22 |
| Connecting an audio device..... | 24 |
| Installing a security cable | 25 |
| Setting up your workspace..... | 26 |
| Adjust your monitor | 26 |
| Stay active | 27 |
| Watch your eyes..... | 28 |
| Blue light..... | 28 |
| Screen flicker..... | 28 |
| Using the monitor | 29 |
| Turning on the monitor..... | 29 |
| Turning off the monitor | 30 |
| Cool features..... | 31 |
| One-cable solution..... | 31 |
| Quick actions..... | 33 |
| Using the on-screen display..... | 34 |
| Controlling the OSD menu..... | 34 |
| OSD components..... | 36 |
| Live information display | 36 |
| OSD menu | 36 |
| Input/Output menu | 37 |

| | |
|--------------------------------------|----|
| Select video input source..... | 37 |
| Volume..... | 37 |
| Split-screen mode..... | 37 |
| Secondary input source | 37 |
| Audio source | 38 |
| USB Type-C port mode | 38 |
| HDMI port 1 mode | 38 |
| HDMI port 2 mode..... | 38 |
| DisplayPort mode..... | 38 |
| USB hub menu | 39 |
| Host device override | 39 |
| Type-C host device..... | 39 |
| DisplayPort host device..... | 39 |
| HDMI 1 host device..... | 40 |
| HDMI 2 host device | 40 |
| Power delivery..... | 40 |
| Gaming menu..... | 41 |
| Frame rate counter | 41 |
| Frame rate counter color..... | 41 |
| Crosshair..... | 41 |
| Crosshair color | 42 |
| Crosshair style..... | 42 |
| Crosshair position..... | 42 |
| Presets menu..... | 43 |
| Load factory defaults | 43 |
| Load user preset 1..... | 43 |
| Load user preset 2 | 43 |
| Load user preset 3 | 43 |
| Save preset..... | 43 |
| Picture menu..... | 44 |
| Color space..... | 44 |
| Brightness | 44 |
| Contrast..... | 44 |
| Sharpness | 44 |
| Color temperature..... | 44 |
| User-defined color temperature | 44 |
| Gamma..... | 45 |
| Backlight dimming | 45 |
| Aspect ratio..... | 45 |

| | |
|--|-----------|
| Performance menu | 46 |
| Low-latency mode | 46 |
| Adaptive-Sync / VRR..... | 46 |
| Response time overdrive | 46 |
| User-defined overdrive | 46 |
| Backlight strobing | 46 |
| User-defined pulse width | 46 |
| User-defined pulse phase | 46 |
| OSD menu | 47 |
| Language | 47 |
| Position | 47 |
| Transparency | 47 |
| Time-out | 47 |
| Rotation..... | 47 |
| Indicator light menu..... | 48 |
| On Behavior | 48 |
| On color: Red / Green / Blue..... | 48 |
| Standby behavior | 48 |
| Standby color: Red / Green / Blue | 48 |
| Information menu | 49 |
| Model | 49 |
| Serial number | 49 |
| Firmware version | 49 |
| Support and troubleshooting..... | 50 |
| Cable requirements | 50 |
| DisplayPort | 50 |
| HDMI | 51 |
| USB Type-C | 52 |
| Solving common problems | 54 |
| Updating firmware | 55 |
| Contacting support | 57 |
| Locating the model and serial number | 57 |
| Maintaining the monitor..... | 58 |
| Maintenance guidelines..... | 58 |
| Cleaning..... | 59 |
| Shipping | 59 |
| Disposal | 59 |
| Technical specifications | 60 |
| Display..... | 61 |
| Size | 61 |

| | |
|---|----|
| Image quality | 61 |
| Speed | 61 |
| Technology | 62 |
| Ports..... | 62 |
| Video input..... | 62 |
| USB hub | 63 |
| Audio | 63 |
| Features..... | 63 |
| Adjustment..... | 64 |
| Stand | 64 |
| Size and weight..... | 64 |
| Electrical and operating requirements | 65 |
| Limited warranty..... | 65 |
| In the box..... | 65 |

Getting started

Important safety information

Only use the power cord and AC adapter that came with your monitor. They're designed to work together and have been tested to ensure they're safe.

Always plug the power cord into an outlet that's easy to reach. When you need to unplug the monitor, hold the plug firmly and pull it out of the outlet. Don't pull the cord itself.

The plug on the power cord is designed to fit into a grounded outlet, which is a safer type of outlet. Make sure the outlet you're using is grounded before you plug in the monitor. Don't disable or remove the grounding pin or use a 2-pin adapter to circumvent it.

Check the ampere rating of the products you have plugged in, and make sure the total rating of everything you've plugged in doesn't exceed the rating of the outlet or power cord. Look at the power label on each device to find its ampere rating.

Don't block or cover the slots and openings on the monitor. This can prevent it from ventilating properly and could cause it to overheat. Don't put anything into the slots or spill any liquid on or into the monitor.

Keep the monitor in a place where it can get good airflow and isn't exposed to too much light, heat, or moisture.

Don't use the monitor in any area where there could be an explosion or fire risk, such as places where chemicals or gases are present. These areas may be marked, but not always. Examples include storage facilities, vehicles using propane or butane, and places where the air contains chemicals, dust, or metal powders.

To protect your computer and monitor, connect all power cords to a surge protection device like a power strip or uninterruptible power supply (UPS). Not all power strips offer surge protection, so make sure the one you use is labeled as such.

To avoid serious injury, set up your workstation properly and maintain good posture and healthy habits while using your computer.

Be careful not to place anything on the power cords or cables. Arrange all cords and cables so that they can't be pulled, stepped on, or tripped over.

Don't drop the monitor or put it on an unstable or vibrating surface. Use furniture that's designed to properly support your monitor. Avoid placing your monitor on dressers, bookcases, shelves, desks, speakers, chests, or carts because it could fall over and cause damage or personal injury.

This product is intended for entertainment purposes. To avoid distractions or disturbing reflections on the screen, consider placing the monitor in an area with controlled lighting. Avoid bright surfaces or direct light sources that could interfere with your viewing experience.

About Spectrum One

At Dough, we believe in putting product decisions in the hands of the end-user. Each and every aspect throughout the development process has been debated and discussed together with our community, a gathering of 10 000 tech enthusiasts who love premium devices with bleeding-edge technology. By putting our minds together with hardcore gamers, coders, and designers, we built the ultimate monitor: Spectrum One.

As a result, your monitor has a unique blend of awesome features. Let's have a look!

Spectrum One is an In-Plane Switching (IPS) monitor that produces rich on-screen colors and creates better viewing angles. This IPS screen is paired with a 144Hz refresh rate and a faster response time of 1ms, giving you both speed and good picture quality. Because you shouldn't have to choose.

The product supports FreeSync™, an Adaptive-Sync technology, and is compatible with G-SYNC®. It is designed to reduce stuttering and tearing in games and videos by locking the monitor's refresh rate to the frame rate of the graphics card. Check with your graphics card manufacturer for compatibility with Adaptive-Sync monitors.

Spectrum One is calibrated at the factory to provide maximum color accuracy in the DCI-P3 color space, so the monitor is ready to use for color critical applications with minimal setup. These factory calibration settings are saved in monitor memory and work independently from the source device used. A one-page calibration report is printed and included with each monitor.

Two High-Definition Multimedia Interface (HDMI) 2.1 video inputs can take an uncompressed 10-bit 4Kp 144Hz image signal from modern graphics cards and offer Adaptive-Sync and high refresh rate features on the latest consoles.

Overdrive and blur reduction settings were tuned by experts to provide usable presets for anyone to start gaming straight out of the box. On top of this, Spectrum One offers unparalleled custom adjustment options for high-speed gaming.

The built-in USB hub can be connected to a host computer using either USB Type-B or Type-C. You can switch between these inputs freely or have them switch along with your video signal to imitate the effect of a KVM switch.

Spectrum One can be connected to a mobile device with a single USB Type-C cable, simultaneously powering or charging the device (up to 100W), displaying an image, playing back audio, and providing access to the built-in USB hub.

You can find more detailed information in the Technical Specifications section on page 60.

Front components

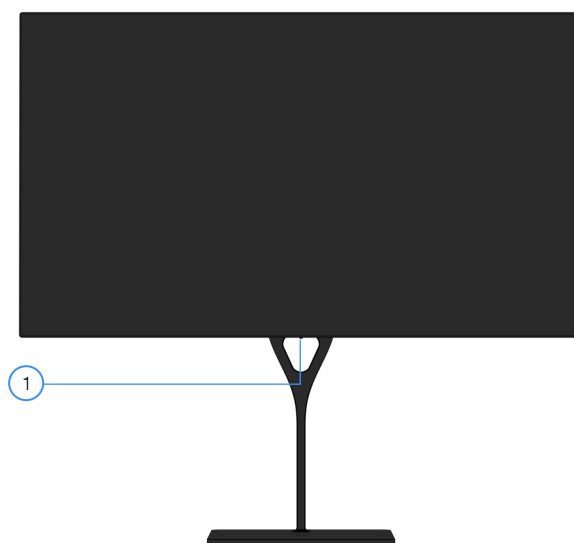

| Component | Description |
|-------------------|--|
| 1 Indicator light | Identifies the current state of the monitor. |

Rear components

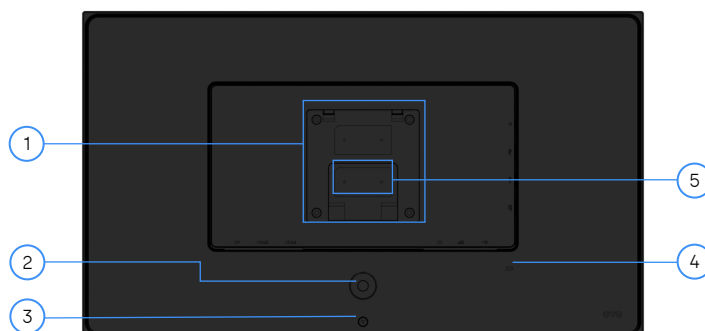

| Component | Description |
|----------------------------|---|
| 1 Stand/VESA connector | Allows you to connect the Spectrum Stand or a VESA-compatible mounting device |
| 2 OSD joystick | Opens the OSD menu, selects an item from the menu, or closes the OSD menu. |
| 3 Power button | Turns the monitor off and on. |
| 4 Kensington security slot | Connect a security cable to secure the monitor to a fixed object. |
| 5 Serial number label | Contains your monitor's unique serial number. |

Rear components

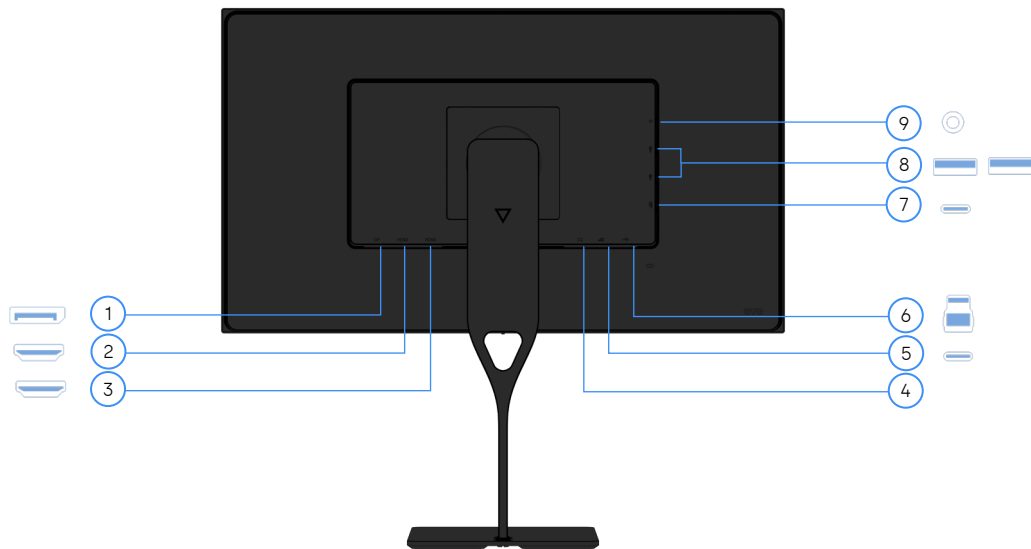

| Component | Description |
|--|---|
| 1 DisplayPort 1.4 port | Connect a DisplayPort cable to a source device such as a computer. |
| 2 HDMI 2.1 port 1 | Connect an HDMI cable to a source device such as a computer or game console. |
| 3 HDMI 2.1 port 2 | Connect an HDMI cable to a source device such as a computer or game console. |
| 4 DC power port | Connect the adapter to power the monitor. |
| 5 USB Type-C port with DP Alt Mode 1.4, USB upstream data, and power delivery up to 100W | Connect a USB Type-C cable to a source device such as a computer. Power or charge devices up to 100W. This port also enables the downstream USB ports to perform their functions. |
| 6 USB Type-B port (upstream) | Connect a USB cable to a source device such as a computer or game console. This port enables the downstream USB ports to perform their functions. |
| 7 USB Type-C SuperSpeed port (downstream) | Connect USB cables to a peripheral device, such as a keyboard, mouse, or USB hard drive. |
| 8 USB Type-A SuperSpeed ports (downstream) (2) | Connect USB cables to a peripheral device, such as a keyboard, mouse, or USB hard drive. |
| 9 3.5mm audio jack | Connect headphones or speakers. |

Setting up Spectrum

It is important to set up your monitor correctly. That way you keep your gear and yourself safe, so you can focus on enjoying your equipment without worry.



IMPORTANT

To prevent damage to the monitor, do not touch the surface of the LCD panel. Pressure on the panel may cause nonuniformity of color or disorientation of the liquid crystals. If this occurs, the screen will not recover to its normal condition.

Installing the Spectrum Stand

The Spectrum Stand (sold separately) was designed from the ground up to be a sleek but sturdy companion to your monitor. To safely attach the Spectrum Stand:

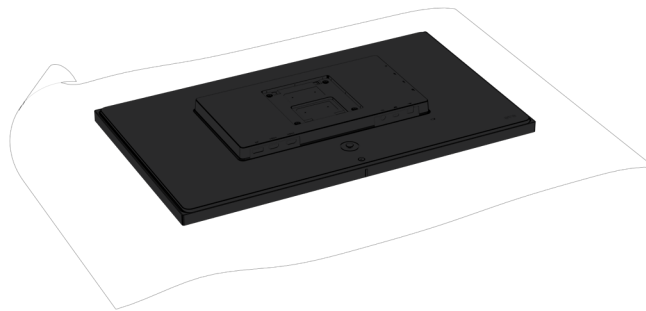

1. Position the monitor face-down on a flat and stable surface.



IMPORTANT

To prevent the screen from getting scratched, defaced, or broken, cover your work surface with protective sheet foam or a non-abrasive cloth.



NOTE

If you have not yet unpacked Spectrum, you can safely attach the stand before removing the monitor from its box.

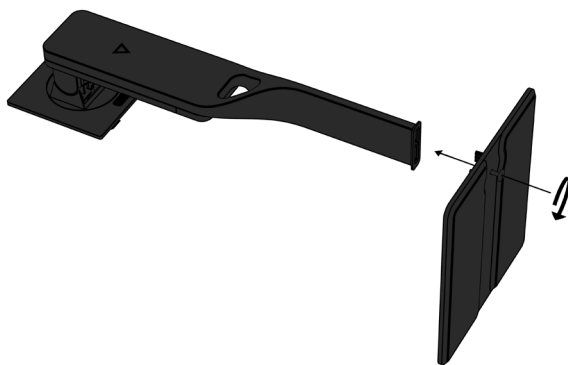

2. Slide the stand's base into the bottom of the stand arm, and then tighten the screw on the underside of the base.

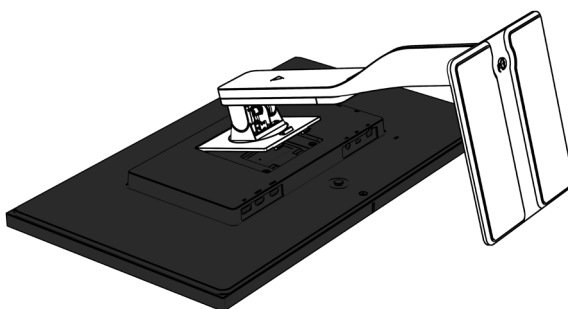

3. Insert the top of the stand into the back of the monitor cabinet at an angle, then press down. The stand will click into place.



NOTE

The Dough Spectrum Stand (model ES07D04) is sold separately.

Removing the Spectrum Stand

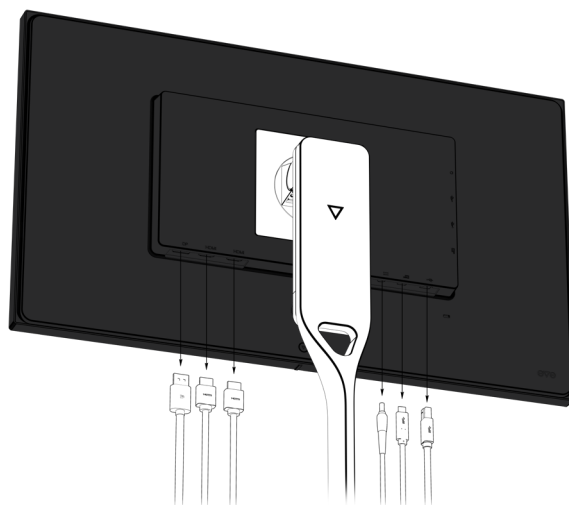

1. Disconnect and remove all cables from the monitor.
2. Position the monitor face-down on a flat and stable surface.



IMPORTANT

To prevent the screen from getting scratched, defaced, or broken, cover your work surface with protective sheet foam or a non-abrasive cloth.

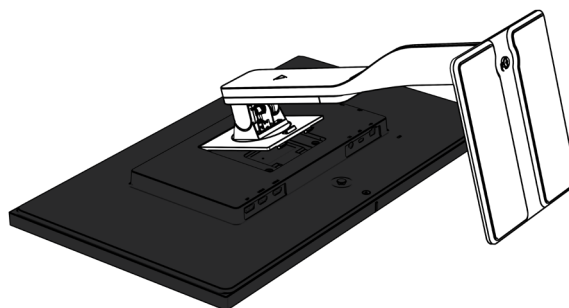

3. Slide up the quick-release button on the stand and lift the stand away from the monitor.



NOTE

The Dough Spectrum Stand (model ES07D04) is sold separately.

Attaching a VESA mount

Spectrum is compatible with most VESA mounting arms and mounts (sold separately). The VESA mount must support the 100×100mm VESA Mounting Standard and should be rated to hold at least 5.0kg of weight.



IMPORTANT

You might need additional tools such as a screwdriver (purchased separately) when you attach a mounting device.

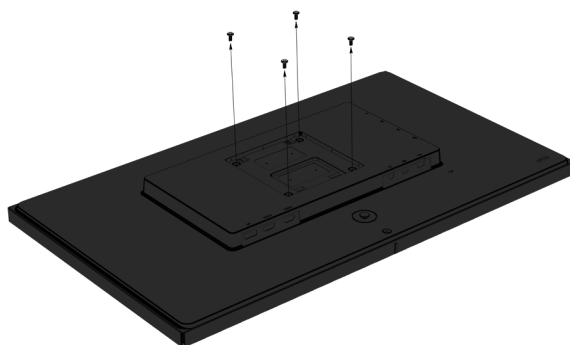

1. Remove the four mounting screws from the back of the monitor.

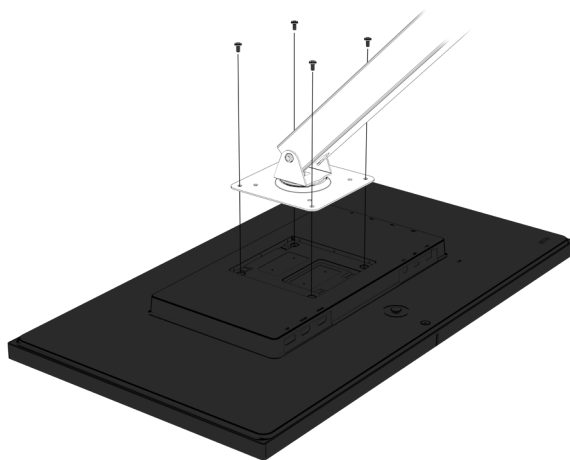

2. Align the screw holes on your mounting device with the four VESA screw holes in the back of the monitor, then insert and tighten the four mounting screws through the mounting device and into the monitor.

**IMPORTANT**

These are generic instructions that may not apply to your mounting device. Always follow the mounting device manufacturer's instructions when mounting the monitor to a wall or swing arm.

Spectrum comes with four M4×10mm screws. To ensure that your monitor is mounted securely, you may need to use screws of a different length, that may or may not have been provided with your mounting device.

Connecting the power cable

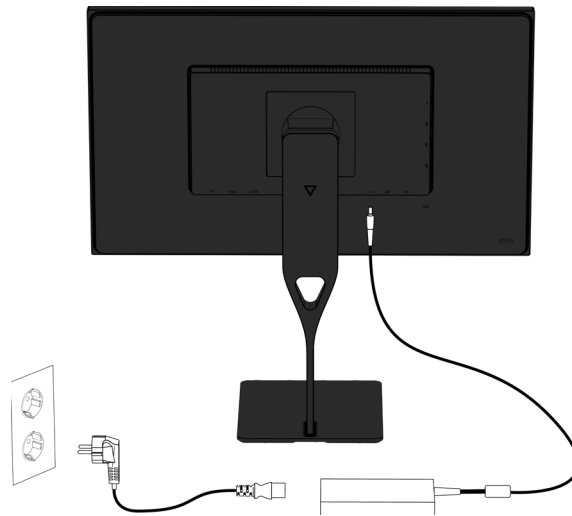

Connect the power cord to the AC adapter and plug the other end into a grounded AC outlet. Then connect the adapter to the DC power connector on the rear of the monitor.



CAUTION

To reduce the risk of electric shock or damage to the equipment:

Only use the power cord and AC adapter that came with your monitor. They're designed to work together and have been tested to ensure they're safe.

The plug on the power cord is designed to fit into a grounded outlet, which is a safer type of outlet. Make sure the outlet you're using is grounded before you plug in the monitor. Don't disable or remove the grounding pin or use a 2-pin adapter to circumvent it.

Check the ampere rating of the products you have plugged in, and make sure the total rating of everything you've plugged in doesn't exceed the rating of the outlet or power cord. Look at the power label on each device to find its ampere rating.

Be careful not to place anything on the power cords or cables. Arrange all cords and cables so that they can't be pulled, stepped on, or tripped over.

Always plug the power cord into an outlet that's easy to reach. When you need to unplug the monitor, hold the plug firmly and pull it out of the outlet. Don't pull the cord itself.

Connecting video cables

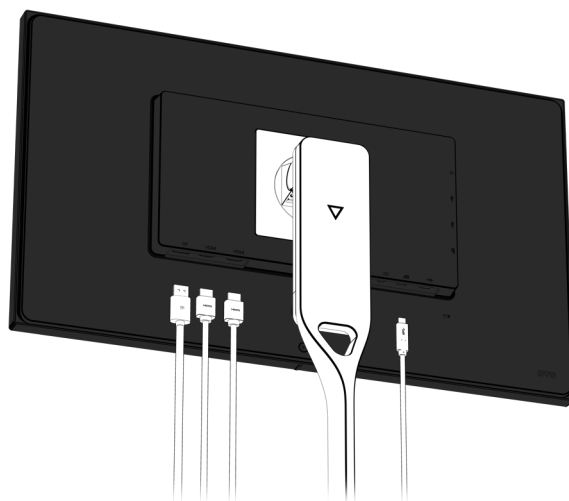

- Connect one end of an HDMI cable to one of the HDMI ports along the bottom of the monitor, and the other end to the HDMI port on the source device;
- Connect one end of a DisplayPort cable to the DisplayPort connector along the bottom of the monitor, and the other end to the DisplayPort connector on the source device; and/or
- Connect one end of a USB Type-C cable to the USB Type-C port along the bottom of the monitor, and the other end to the USB Type-C port on the source device.



CAUTION

When powering or charging your device via USB Type-C, DC power does not need to be connected. Do not connect two power sources (DC power in and USB Type-C) to the host device simultaneously.

Use only USB Type-C cables that are rated for up to 100W of power delivery. The use of inappropriate cables could represent a fire hazard. Charging at high power can cause high temperatures. Consult the documentation that came with your device about fire safety.



IMPORTANT

The host computer must be able to support the USB Power Delivery protocol over the USB Type-C connector to be charged or powered by Spectrum.

The host computer must be able to support DisplayPort Alternate Mode over the USB Type-C connector to provide Spectrum with an image signal.

**NOTE**

The monitor automatically determines which inputs have valid video signals. You can also select inputs manually using the on-screen display (OSD) menu.

With so many ports available, it isn't surprising that not everyone intends to use the same cable types or cable lengths. Our surveys show that because of this, more than half the cables we could have included in the box would have gone to waste. That's not good for the environment, and it's not good for your wallet, either. With this in mind, we ship our monitors without cables.

Connecting USB devices

The built-in USB hub

Spectrum has a built-in USB hub that allows you to connect multiple devices to your computer with a single cable.

The USB hub lets you plug in many devices at once, even if your computer doesn't have enough built-in ports. And instead of having cords all over your desk, you can gather them neatly in one spot. Only one USB cable is needed to connect your monitor to your computer.

Because the monitor also has a built-in USB switch, you can connect to up to two computers, and switch which of the two controls your USB devices, either manually or automatically based on the video port in use. You can learn more about setting up which port controls the built-in hub on page 38.

Connecting peripheral devices

The side of the monitor provides one USB Type-C and two USB Type-A downstream ports. You can use these to connect devices such as a mouse, keyboard, phone, external hard drive or solid-state drive, and practically anything that is USB-connected.

The monitor can also charge attached devices, at up to 15W through the USB Type-C port, or up to 10W through the USB Type-A ports. You can control whether these devices continue charging while the monitor is turned off in the OSD menu. You can learn more about this setting on page 40.

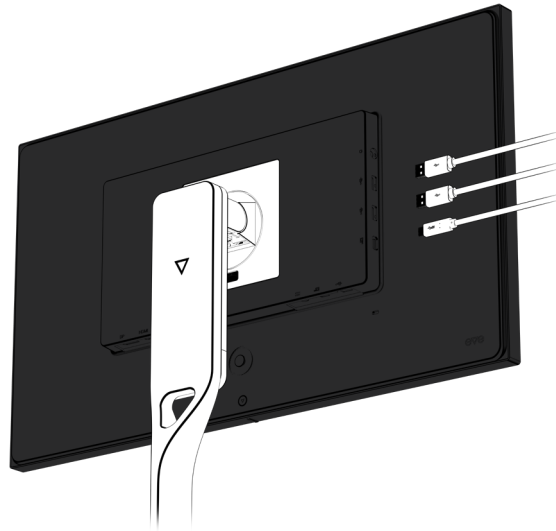

1. Connect one or more peripheral devices.

- Connect a USB peripheral device or its cable to one of, or both the USB Type-A ports on the side of the monitor; and/or
- Connect a USB peripheral device or its cable to the USB Type-C port on the side of the monitor.



IMPORTANT

Do not switch between USB upstream ports while a storage device connected to the downstream ports is in use, as this may cause data loss. For the same reason, it is not recommended to enable automatic USB hub host switching in the OSD menu if storage devices are attached to Spectrum's downstream ports.



NOTE

Spectrum's built-in USB hub supports speeds up to 10Gbps. The actual speeds may vary based on the connected peripherals and the capabilities of the USB port on the host device.

Connecting to the USB host device(s)

The bottom of the monitor provides one USB Type-B and one USB Type-C upstream port. Either can be used to connect the built-in USB hub to a host device.

Connecting both USB ports along the bottom to two separate host devices simultaneously allows you to select which of the connected host devices controls the USB hub from the on-screen display (OSD) menu. Only one host device can make use of the built-in USB hub at any time. You can learn more about USB hub settings on page 38.

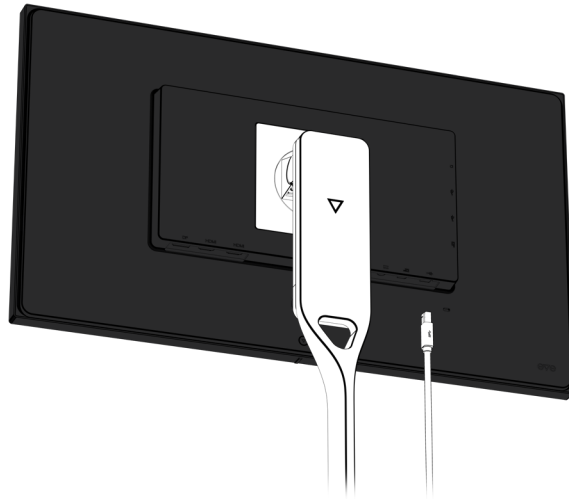

1. Connect an upstream cable for the built-in USB hub.

- If you connected Spectrum to the video source device using the USB Type-C port along the bottom of the monitor, this same cable can double as the upstream cable for the built-in USB hub; and/or
- If you connected Spectrum to the video source device using HDMI or DisplayPort, you will need to connect one end of a USB cable to either the USB Type-B or USB Type-C port along the bottom of the monitor, and the other end to a USB port on the host device.

**NOTE**

You must connect either one of, or both the USB upstream ports along the bottom of the monitor to the host device (computer, laptop, gaming console) to make use of USB ports of the built-in USB hub.

When connected by a single USB Type-C cable, Spectrum may not be able to simultaneously operate the built-in USB hub at its full speed and run the display at its maximum resolution, refresh rate, and color depth due to technical limitations. The bandwidth priority can be set in the OSD. You can learn more about setting your priority preferences on page 38.

Spectrum's built-in USB hub supports speeds up to 10Gbps. The actual speeds may vary based on the connected peripherals and the capabilities of the USB port on the host device.

When used only to enable the built-in USB hub, either of these ports can be connected using a cable with a USB Type-A connector on the end that plugs into the computer. When the USB Type-C port is used to receive a video signal, audio signal, and/or to provide power, only a suitable cable with a USB Type-C connector on both ends will suffice.

Connecting an audio device

Spectrum has a built-in digital-to-analog converter (DAC) that sends audio signals from the video source device to the amplified 3.5mm audio jack connector on the rear of the monitor.

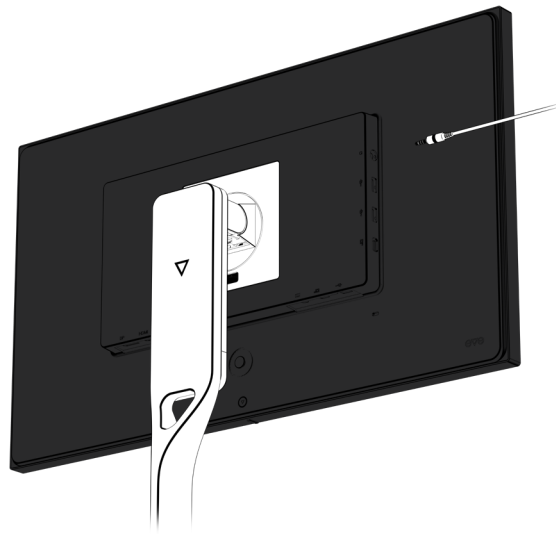

- Connect the 3.5mm audio jack plug to the audio port on the rear of the monitor to make use of your speakers, headphones, or other audio device.



CAUTION

To reduce the risk of personal injury, adjust the source device volume before using headphones, earbuds, or a headset. Gradually increase the volume until you can hear it clearly, comfortably and without distortion. Limit the amount of time you are subjected to high-volume sound.

Installing a security cable

You can secure the monitor to a fixed object with an optional security cable available from third parties.

- Connect the lock to the Kensington Security Slot on the rear of the monitor and use the key provided to attach and remove the lock.



IMPORTANT

If these instructions do not apply to your security cable, then follow the lock manufacturer's instructions when securing the monitor.

Setting up your workspace

...or setting up your battle station.

When setting up your workspace, whether it's for work or gaming, it's important to prioritize your safety and health. This means maintaining proper posture, health, and work habits, as well as setting up an ergonomic workspace with a properly positioned monitor.

Prolonged computer use can cause discomfort, headaches, eyestrain, or physical injury. If you experience numbness, aching, pain, stiffness, or any recurring or persistent discomfort or pain, take a break and consider consulting a medical professional.

Adjust your monitor

1. Adjust the monitor's height to a comfortable position for your individual workstation. The monitor's top bezel edge should not exceed a height that is parallel to your eye height.



NOTE

A monitor that is positioned low and reclined might be more comfortable for users with corrective lenses.

2. Tilt the monitor forward or backward to set it to a comfortable eye level.

3. Using the Spectrum Stand or select VESA monitor mounts, you can pivot the monitor from landscape to portrait orientation. This lets you adapt the layout of your screen to your applications.

When using the Spectrum Stand:

- a. Adjust the monitor to its highest position.
- b. Pivot the monitor 90° clockwise or counterclockwise from landscape to portrait orientation.



IMPORTANT

If the monitor is not in full height position when pivoting, the bottom corner of the monitor panel will come in contact with the base and potentially cause damage to the monitor or the stand.



NOTE

If you use the monitor in any orientation other than right-side-up, you can rotate the OSD menu and joystick controls to match the new orientation. You can learn more about adjusting the OSD on page 47.

Stay active

Reposition your monitor as you adjust your working posture throughout the workday. Don't stay in one fixed posture for too long, but avoid slouching or leaning, and get up to move around regularly.

To avoid discomfort and injury, it's important to take regular breaks while using the computer. Go outside, take a few deep breaths of fresh air, stretch, and exercise to take care of your body. This will not only help you maintain good health but can also boost your creativity, alertness, and reflexes, which can be beneficial whether you're aiming for a promotion or aiming for that elusive enemy sniper.



NOTE

The perfect working posture may require third-party accessories such as adjustable or ergonomic chairs, footrests, or specialized peripherals. All bodies are different, so try different things to find out what makes you most comfortable!

Watch your eyes

Take frequent breaks to rest your eyes. To avoid eye strain, it can help to look away from the monitor and focus on a distant point. Make sure your room is well-lit, and wear glasses or contact lenses if necessary.

Adjust the position of Spectrum to eliminate screen glare from windows or light sources.

Adjust the brightness and contrast settings on your monitor to enhance text and image clarity. You can learn more about adjusting the image on page 44.

Keep your Spectrum clean from dust and stains to maintain its readability and clarity. You can learn more about cleaning the screen on page 59.

Blue light

Visible light contains a range of wavelengths and energy. Blue light, which has the highest energy in the visible light spectrum, can potentially harm the eyes more than other visible light.

Sunlight is the main source of blue light, but excessive exposure to artificial blue light from computer screens can cause eye strain and discomfort, especially in dark environments.

To reduce the amount of blue light emitted from Spectrum One, you can adjust the color temperature to warm colors or manually adjust the color balance. You can learn more about adjusting the color temperature on page 44.

Screen flicker

The constant on-off cycling of some monitors (also called 'flicker') may force your eyes to work harder to adjust to the changes in brightness.

Prolonged exposure to flickering screens may lead to loss of focus, fatigue, headaches, and blurred vision, especially in individuals who are sensitive to such visual stimuli.

The LED backlight unit used in Spectrum One is based on technologies that do not produce flicker during normal use, and does not rely on pulse-width modulation (PWM).

Using the monitor

Turning on the monitor

1. Press the power button on the computer to turn it on.

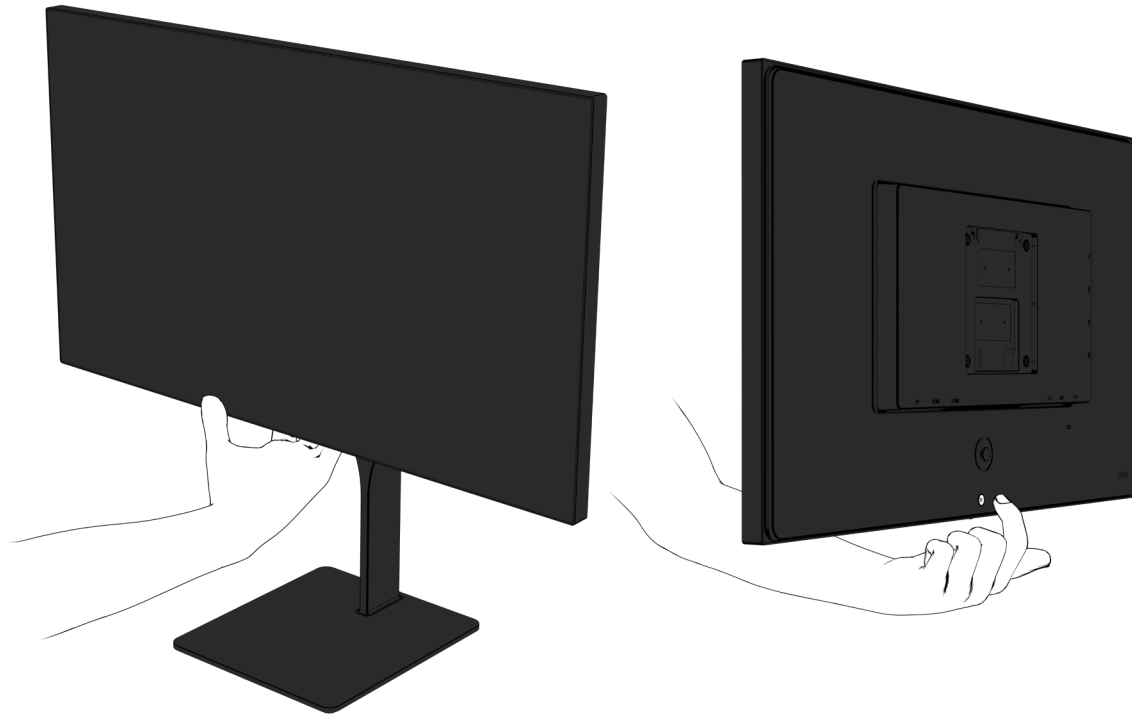

2. Press the power button on the rear of the monitor to turn it on.

When the monitor is first turned on, the monitor automatically scans the signal inputs for an active input and uses that input for the screen.

The indicator light at the bottom of the monitor will light up white when the monitor is active.



NOTE

You can change the behavior of the indicator light or disable it entirely in the on-screen display (OSD) menu.

Turning off the monitor

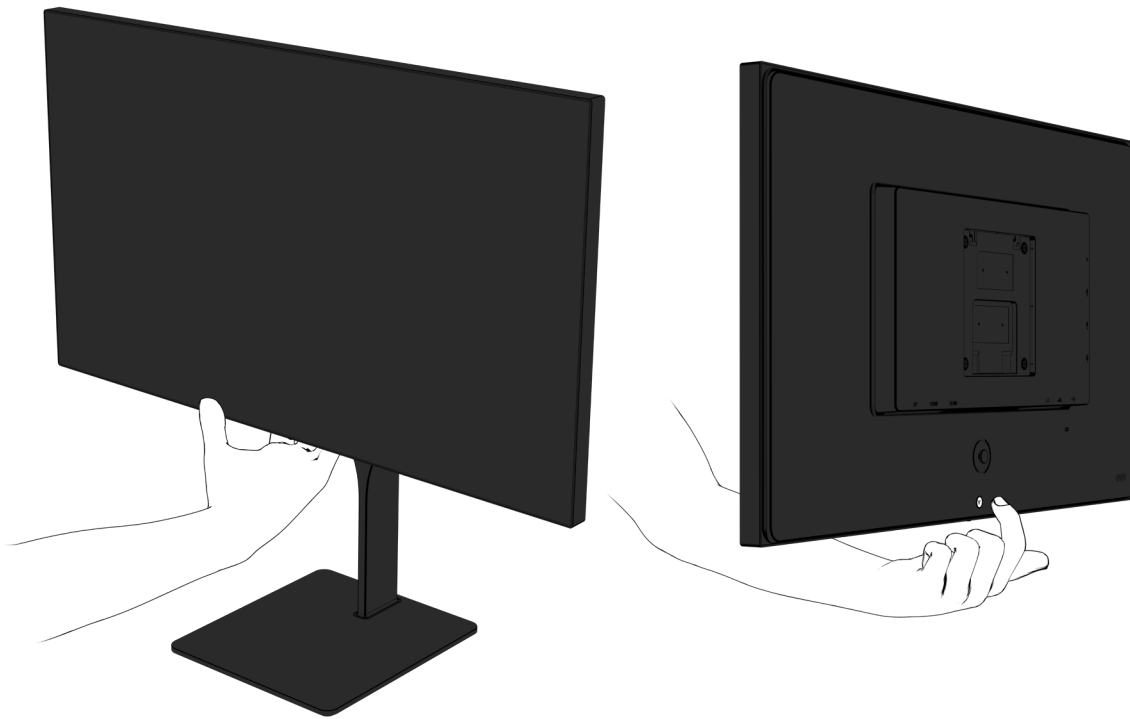

1. Press the power button on the rear of the monitor to turn it off.



NOTE

If there is no video signal for a prolonged period, the monitor will enter standby mode. This means that the monitor is not turned off and will resume operation once a video signal is available again. By default, the indicator light will gradually dim and brighten in a breathing effect to indicate standby mode.

Cool features

One-cable solution

Typically, separate cables are needed to connect your monitor to your computer for video, audio, and USB data. Additionally, yet another cable is required to charge your laptop or other mobile device. With USB Type-C, you can do all of that with just one cable, simplifying the setup process. It's also a neat and straightforward way to declutter your desk from a tangle of cables.

You can attach a computer, notebook, or similar device to the monitor with a single USB Type-C cable, which then provides connectivity for high-speed data, audio, video, and up to 100W of power or charging.

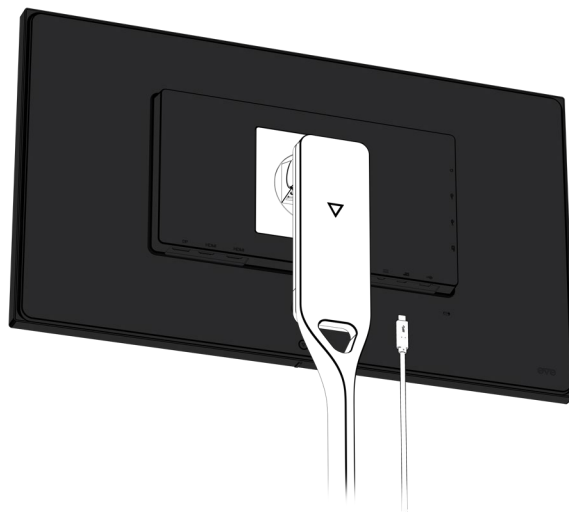

- Connect one end of a USB Type-C cable to the USB Type-C port along the bottom of the monitor and the other end to the USB Type-C port on the computer, notebook, or other device.



CAUTION

When powering or charging your device via USB Type-C, DC power does not need to be connected. Do not connect two power sources (DC power in and USB Type-C) to the host device simultaneously.

Use only USB Type-C cables that are rated for up to 100W of power delivery. The use of inappropriate cables could represent a fire hazard. Charging at high power can cause high temperatures. Consult the documentation that came with your device about fire safety.

**IMPORTANT**

The host computer must be able to support the USB Power Delivery protocol over the USB Type-C connector to be charged or powered by Spectrum.

The host computer must be able to support DisplayPort Alternate Mode over the USB Type-C connector to provide Spectrum with an image signal.

**NOTE**

When connected by a single USB Type-C cable, Spectrum may not be able to simultaneously operate the built-in USB hub at its full speed and run the display at its maximum resolution, refresh rate, and color depth due to technical limitations. The bandwidth priority can be set in the OSD. You can learn more about setting your priority preferences on page 38.

Spectrum's built-in USB hub supports speeds up to 10Gbps. The actual speeds may vary based on the connected peripherals and the capabilities of the USB port on the host device.

Quick actions

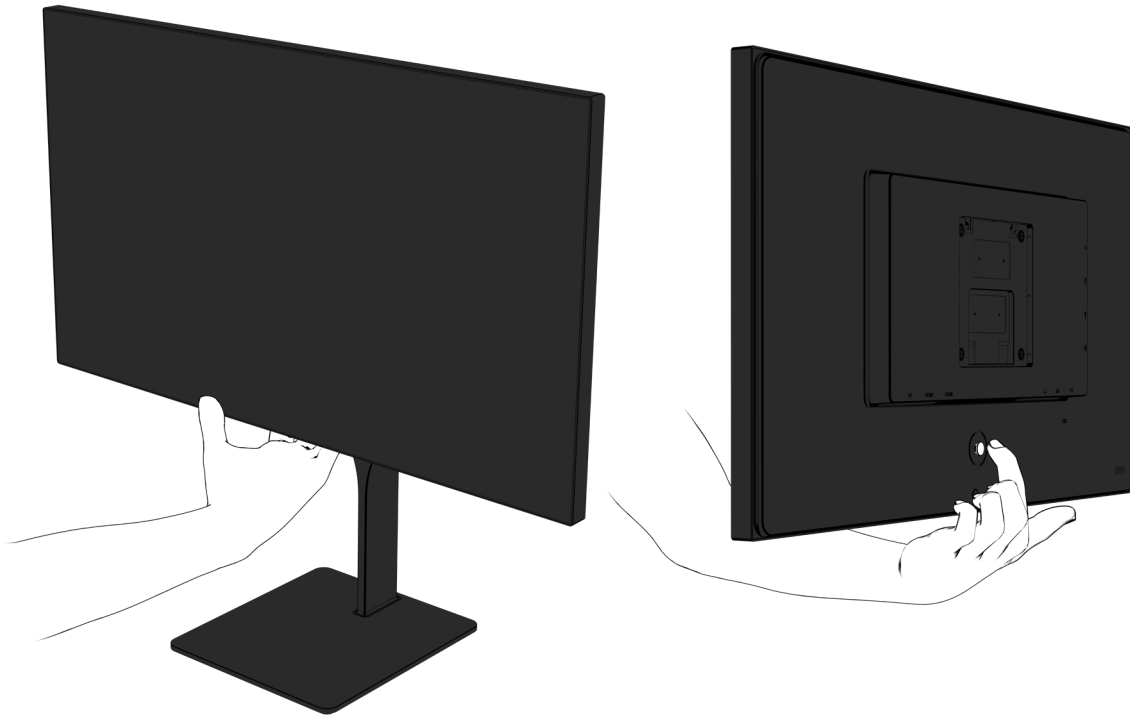

If the OSD menu, crosshair overlay, and frame rate counter overlay are not active, pressing the joystick in any direction will perform quick actions. This lets you quickly enable or disable features, or cycle through available options:

- Pressing down will cycle video input sources.
- Pressing up will cycle USB hub input sources.
- Pressing left will enable or disable the frame counter overlay.
- Pressing right will enable or disable the crosshair overlay.



NOTE

These quick actions are not available when Spectrum is in standby mode. Depressing the joystick will temporarily activate the monitor and allow the changing of video- and USB hub input sources.

On model ES07D03, some of these quick actions are only available when using firmware version 106 or newer.

Using the on-screen display

Use the on-screen display (OSD) menu to display information about your monitor, or to adjust the picture properties and monitor features based on your preferences.

Controlling the OSD menu

While the monitor is turned on, you can access the menu and make adjustments using the joystick on the rear of the monitor by reaching underneath the bottom bezel.

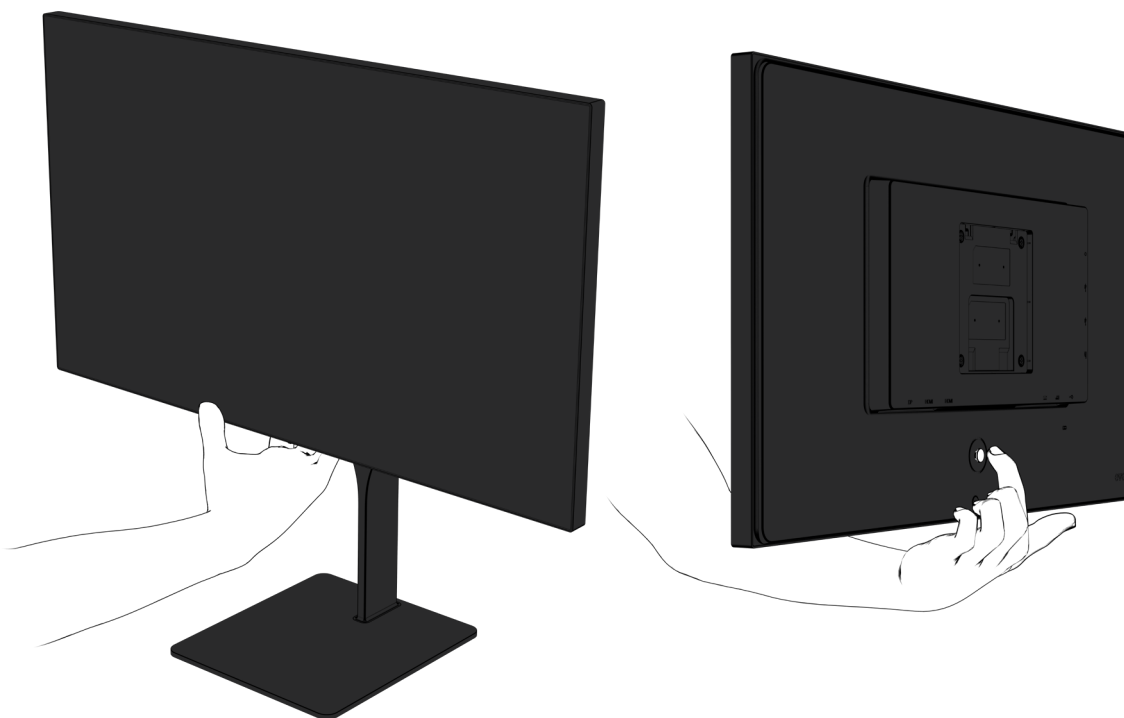

1. To access the OSD menu, depress the joystick to open the OSD.
2. Use the joystick to navigate, select, and adjust the menu choices.
 - Pressing up or down will change the current selection or adjust the current setting.
 - Pressing right will confirm the currently highlighted choice and proceed to the next submenu.
 - Pressing left will return to the previous menu level.



NOTE

Most settings will automatically be applied and stored as you cycle through the available options. Some settings do require you to confirm your selection by pressing right once more, before returning to the previous menu level or closing the OSD menu. These are generally settings that could cause compatibility issues or jarring changes in the display.

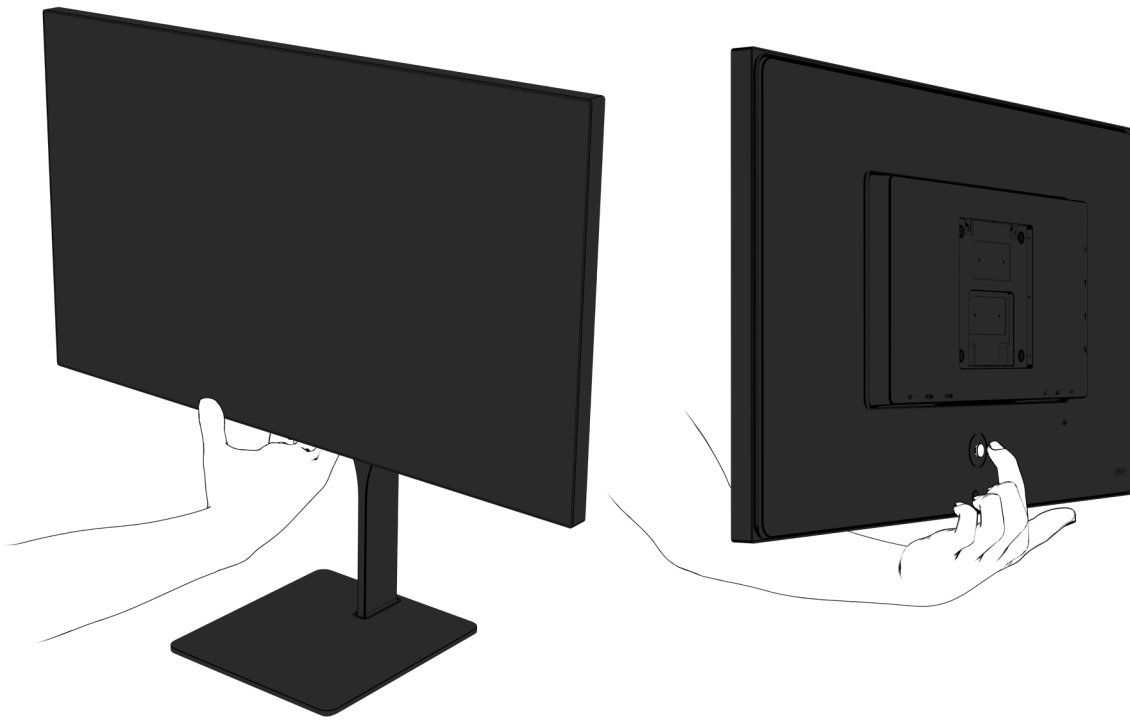

4. To close the OSD menu, depress the joystick. Alternatively, pressing the joystick left whilst in the main menu will close the menu. Finally, if no control inputs are given for a prolonged time, the OSD menu will close automatically.

**NOTE**

You can adjust the duration of this time-out in the 'OSD' submenu. You can learn more about adjusting the OSD time-out on page 47.

OSD components

Live information display

The live information display along the top shows the currently active signal source. Here you can quickly find information about your active inputs, resolution, refresh rate, and the use of HDR.

OSD menu

The OSD menu contains the settings that control your monitor's behavior. Here you can change the color qualities of the displayed image, as well as a slew of settings that allow you to fine-tune the features of the monitor.

The leftmost column contains the main menu, which contains categories of settings.

The middle column contains the settings of the current category.

The rightmost column displays the current values for each setting, or lets you choose your preferred value for the setting you are currently adjusting.

A white outline marks the currently active menu item.

You can learn more about the various settings and their effects from page 37 onwards.

Input/Output menu

Select video input source

Selects from which port the video source device is connected. When set to 'Select automatically', the monitor automatically switches to an active input, if the current input is not active.



NOTE

When set to 'Select automatically', the monitor may need more time to resume from sleep, as it will cycle through the available ports on by one, looking for a signal.

By default, you can quickly cycle through the various input sources by pressing the joystick down when the OSD menu is not active.

Volume

Adjusts the output volume for the built-in audio jack.



CAUTION

To reduce the risk of personal injury, adjust the source device volume before using headphones, earbuds, or a headset.

Split-screen mode

Enables showing an image from two display input sources side-by-side. Also known as 'Picture besides picture mode'.



NOTE

On model ES07D03, to enable Split-screen mode and its affiliated settings Spectrum must be updated to firmware version 106 or newer.

Secondary input source

Selects from which display input port the second image is shown in split-screen mode. This setting is only available when 'Split-screen mode' is set to 'On'.

Audio source

Selects from which of the two active input sources the audio is played in split-screen mode. This setting is only available when 'Split-screen mode' is set to 'On'.

USB Type-C port mode

Selects between maximum video signal bandwidth, or maximum USB hub data bandwidth for the USB Type-C port.

| | maximum USB hub bandwidth | maximum refresh rate at 4K |
|---------------------|---------------------------|----------------------------|
| High USB data speed | 10Gbps | 144Hz with DSC/ 60Hz |
| High refresh rate | 480Mbps | 144Hz |



NOTE

The exact bandwidth usage is determined by a combination of resolution, refresh rate, color depth, and compression. Changing any one of these factors may alter the limits imposed on the others.

To reach 144Hz refresh rate when USB-C bandwidth priority is set to High USB data speed, your video source device must support display stream compression (DSC).

On model ES07D03, to reach 144Hz refresh rate when USB-C bandwidth priority is set to High USB data speed, Spectrum must be updated to firmware version 107 or newer.

HDMI port 1 mode

Selects between the maximum performance of HDMI 2.1, or maximum compatibility with previous HDMI versions for HDMI port 1.

HDMI port 2 mode

Selects between the maximum performance of HDMI 2.1, or maximum compatibility with previous HDMI versions for HDMI port 2.

DisplayPort mode

Selects between the maximum performance of DisplayPort 1.4, or maximum compatibility with previous DisplayPort versions for the DisplayPort and USB Type-C ports.

USB hub menu



NOTE

On model ES07D03, to access this menu, Spectrum must be updated to firmware version 108 or newer. Some features may still be available elsewhere in the OSD.

Host device override

Forces the monitor to ignore individual port settings and always use either the USB Type-B or Type-C port to connect to the built-in USB hub to its upstream host device. When set to 'Off', the USB source switches automatically based on the individual port settings below.



IMPORTANT

Do not switch between USB upstream ports while a storage device connected to the downstream ports is in use, as this may cause data loss. For the same reason, it is not recommended to enable automatic USB hub host switching in the OSD menu if storage devices are attached to Spectrum's downstream ports.



NOTE

By default, you can quickly cycle through the various USB host device settings by pressing the joystick down when the OSD menu is not active.

If the firmware currently installed does not contain the 'USB hub' menu, the 'Host device override' feature may be found in the 'Input/Output' menu as 'Select USB hub source'. We recommend installing the latest firmware to unlock the full suite of USB hub customization options.

Type-C host device

Selects from which port the USB hub upstream host device is connected, when the USB Type-C port is the active video signal input port.

DisplayPort host device

Selects from which port the USB hub upstream host device is connected, when the DisplayPort port is the active video signal input port.

HDMI 1 host device

Selects from which port the USB hub upstream host device is connected, when HDMI port 1 is the active video signal input port.

HDMI 2 host device

Selects from which port the USB hub upstream host device is connected, when HDMI port 2 is the active video signal input port.

Power delivery

Selects the behavior of the built-in USB hub, when the monitor is turned off. When set to 'Always on', devices connected to the downstream USB ports of Spectrum will always be available to the host device, even when Spectrum is turned off (this still requires the monitor to be connected to AC power). When set to 'Turn off with monitor', devices connected to the downstream USB ports of Spectrum will only be available to the host device when the monitor is either in standby mode or active. This mode slightly reduces power consumption when the monitor is off.



NOTE

If the firmware currently installed does not contain the 'USB hub' menu, the 'Power delivery' feature may be found in the 'Input/Output' menu as 'USB hub'. We recommend installing the latest firmware to unlock the full suite of USB hub customization options.

Gaming menu

Frame rate counter

Enables or disables a live display of the current input frame rate.



NOTE

While the OSD menu is active, the frame rate counter cannot be displayed. If enabled, it will appear once the menu is closed.

By default, you can quickly toggle the frame rate counter on and off by pressing the joystick left when the OSD menu is not active.

As the monitor received no direct frame rate information from the graphics card, the frame rate displayed is based on the refresh rate. This means that it is only accurate when adaptive-sync is active.

At low frame rates, the graphics card may use a technique called low framerate compensation (LFC), duplicating frames to match the minimum refresh rate of Spectrum.

As Spectrum cannot differentiate between new frames and their duplicates the frame rate counter will in this case show the total number of frames generated by the graphics card (48). This may differ from the number of unique frames as displayed by some software-based frame rate counters.

Frame rate counter color

Selects the color of the frame rate counter.

Crosshair

Enables or disables a targeting reticule overlay.



NOTE

While the OSD menu is active, the crosshair cannot be displayed. If enabled, it will appear once the menu is closed.

By default, you can quickly toggle the crosshair on and off by pressing the joystick right when the OSD menu is not active.

Crosshair color

Selects the color of the crosshair.

Crosshair style

Selects the style of the crosshair.



Crosshair position

Adjusts the height at which the crosshair appears on the screen. (100 places the crosshair at the center of the display.)



NOTE

You can quickly adjust the position of the crosshair by pressing the joystick up or down when the crosshair overlay is active.

Presets menu

Load factory defaults

Overwrites all monitor settings with those stored in the factory setting profile for the monitor, restoring default values. This does not overwrite the user presets.

Load user preset 1

Overwrites all monitor settings with those stored in user-generated setting profile 1. This does not overwrite any user presets.

Load user preset 2

Overwrites all monitor settings with those stored in user-generated setting profile 2. This does not overwrite any user presets.

Load user preset 3

Overwrites all monitor settings with those stored in user-generated setting profile 3. This does not overwrite any user presets.

Save preset

Overwrites all monitor settings in the selected setting profile with the current values. This does not overwrite any other user presets.

Picture menu



NOTE

While HDR is enabled, the only option available in this menu is 'Sharpness'.

Color space

Selects the color space in which the monitor operates. P3 is the native color space of the display panel, and offers the widest range of colors. In sRGB mode colors are adjusted to avoid overshoot in colors.

Brightness

Adjusts much light the monitor emits.

Contrast

Adjusts the difference between light and dark areas of the monitor.

Sharpness

Adjusts how much the monitor emphasizes edges in the image.

Color temperature

Adjusts the colors of the monitor to match warm, cool, or neutral environmental light.

User-defined color temperature

Allows for individual manual control of red, green, and blue light values to manually adjust the white balance of the image. This setting is only available when 'Color temperature' is set to 'User defined'.

Gamma

Adjusts the brightness curve between light and dark areas of the monitor.

Backlight dimming

Selects the backlight dimming behavior.

- When HDR is active, this setting defaults to 'Local', where individual zones of the backlight are dimmed or brightened to increase the dynamic contrast between lighter and darker areas of the image.
- When HDR is not active, this setting defaults to 'Off', where the monitor does not adjust the brightness of the backlight over time.

Aspect ratio

Selects the method used for displaying content below native resolution.

| | image upscaling behavior |
|-----------------------|--|
| Maintain aspect ratio | The image is scaled up as large as will fit on the display, without deforming it. This is a common default for TVs. |
| Pixel perfect | The image is scaled up by duplicating pixels at an integer ratio, as large as will fit on the display. This preserves the image quality of pixel art in retro games. |
| Stretch to fill | The image is scaled up as large as will fit on the display, even if that stretches the image. |
| 1 : 1 | The image is displayed exactly as per the input signal, even if that only uses a small portion of the screen. |

Performance menu

Low-latency mode

Selects between the compatibility of a traditional frame buffer, or a line buffer to streamline input and output refresh rate.

Adaptive-Sync / VRR

Enables or disables support for variable refresh rates (VRR) through adaptive-sync technology. This feature enables AMD FreeSync, NVIDIA G-SYNC, VESA Adaptive-Sync, and HDMI-VRR features. This setting is shown as 'Adaptive-Sync' when connected through the DisplayPort or USB Type-C video input, or as 'VRR' when connected through the HDMI video input.

Response time overdrive

Selects a preset to determine how much overdrive is applied to pixel transitions.

User-defined overdrive

Adjusts how much overdrive is applied to pixel transitions. Two separate values are controlled by this setting depending on whether 'Backlight strobing' is enabled or disabled. In either case, the relevant value is displayed and controlled by this setting. This setting is only available when 'Response time overdrive' is set to 'User defined'.

Backlight strobing

Selects a preset to determine how long the backlight is active for each refresh cycle, to reduce motion blur. When set to 'Off', the backlight does not strobe and is active continuously.

User-defined pulse width

Adjusts how long the backlight is active for each refresh cycle, to reduce motion blur. This setting is only available when 'Backlight strobing' is set to 'User defined'.

User-defined pulse phase

Adjusts at which point during the refresh cycle the backlight becomes active. This setting is only available when 'Backlight strobing' is set to 'User defined'.

OSD menu

Language

Selects the language in which the OSD menu is displayed.

| language | displayed as |
|----------|--------------|
| English | English |
| Chinese | 中文 |
| French | Français |
| German | Deutsch |
| Japanese | 日本語 |
| Spanish | Español |



NOTE

The OSD sub-menu is always called 'OSD'. The 'Language' option in any language is followed by the word 'language' in English. Finally, the name of each language is always displayed in its own language. This way, users who do not speak the currently selected language can always find the language setting to change it.

Position

Selects the location on the screen where the OSD menu is displayed.

Transparency

Adjusts the transparency of the OSD menu overlay.

Time-out

Adjusts the time delay since the last control input, before the OSD menu automatically closes.

Rotation

Selects the orientation of the OSD on the screen and the corresponding orientation of the joystick controls, such that both are upright when the monitor is used in portrait mode.

Indicator light menu

On Behavior

Selects the behavior of the indicator light when the monitor is on.

| | indicator light behavior |
|------------|---|
| Off | Off |
| Steady | Always on |
| Slow pulse | Very slowly breathes on and off |
| Fast pulse | Quickly breathes on and off |
| Slow blink | Slowly but repeatedly turns on and off |
| Fast blink | Quickly and repeatedly turns on and off |

On color: Red / Green / Blue

Adjusts the red, green or blue light value shown by the indicator light when the monitor is on.

Standby behavior

Selects the behavior of the indicator light when the monitor is in standby mode.

The options are described in detail in the description of the 'On behavior' setting earlier in this section.

Standby color: Red / Green / Blue

Adjusts the red, green or blue light value shown by the indicator light when the monitor is in standby mode.

Information menu

Model

Displays the monitor's model and model number.

Serial number

Displays the monitor's unique serial number.

Firmware version

Displays the monitor's current firmware version.

Support and troubleshooting

Cable requirements

There are many different cables on the market, and not all of them will give you the best experience with your monitor. Here are some specifications and certifications you should keep in mind when purchasing a new cable for your monitor.

DisplayPort

DisplayPort is an audio/video interface that was first introduced in 2006 to provide a unified, easy to produce replacement for the variety of monitor connectors that were in use at the time. Though similar in capability to the more famous and TV-focused HDMI, DisplayPort has been designed with a focus on computer monitors. Today, DisplayPort is the best way to connect Spectrum to your desktop PC.

We recommend using a high-quality cable that is certified 'DP8K', has a DisplayPort connector on either end, and is no longer than 3m.

| Goal | Requirement |
|---|---|
| Provide a video signal to the DisplayPort | <p>Certification: Use a cable that is certified 'DP8K'.</p> <p>Connectors: The cable can have a DisplayPort connector on both ends, or can have a DisplayPort connector on the monitor side and a USB Type-C connector on the computer side.</p> <p>Speeds: A cable that is certified 'DP8K' will provide support for all the benefits of DisplayPort 1.4. It will enable Spectrum's maximum resolution, refresh rate, and color depth, and support all its features.</p> <p>Cables of higher certification, such as 'DP40' or 'DP80', will also support all the benefits of DisplayPort 1.4.</p> <p>A cable that is not VESA-certified may only offer support for DisplayPort 1.2. It may not enable Spectrum's maximum resolution, refresh rate, and color depth, and it may not support features such as Display Stream Compression (DSC) and High Dynamic Range (HDR).</p> <p>Spectrum can operate its ports in DisplayPort 1.2 mode, if your computer supports DisplayPort 1.4 but you must use an uncertified cable.</p> |

HDMI

HDMI is an audio/video interface that was first introduced in 2002 to provide a convenient, digital connection between video devices and displays. It has quickly become a wide-spread standard and has evolved over time, with each new version introducing higher bandwidth support and a broader feature set. Today, HDMI is the best way to connect Spectrum to your consoles and other video devices.

We recommend using a high-quality cable that is certified 'Ultra High Speed USB Cable', has an HDMI connector on either end, and is no longer than 5m.

| Goal | Requirement |
|---|---|
| Provide a video signal to one of the HDMI ports | <p data-bbox="483 645 1246 707">Certification: Use a cable that is certified 'Ultra High Speed HDMI Cable'.</p> <p data-bbox="483 754 1198 817">Connectors: The cable must have an HDMI connector on both ends.</p> <p data-bbox="483 864 1350 1028">Speeds: A cable that is certified 'Ultra High Speed HDMI Cable' will provide support for all the benefits of HDMI 2.1. It will enable Spectrum's maximum resolution, refresh rate, and color depth, and support all its features.</p> <p data-bbox="483 1072 1299 1205">A cable with an older or no HDMI certification may not enable Spectrum's maximum resolution, refresh rate, and color depth, and it may not support features such as Display Stream Compression (DSC) and Variable Refresh Rate (VRR).</p> |

USB Type-C

USB Type-C is a data connector that was first introduced in 2014 as a replacement for the existing Type-A and Type-B connectors and their variants. The connector is compact and reversible, making it convenient to use and suitable for small mobile devices. Though developed as the new connector for carrying the USB data protocol, USB Type-C is also capable of transmitting video data using the DisplayPort standard and it can transfer high amounts of power. It is important to note, that even though the connector is technically capable of all these things, not every cable is made to the same standards, and USB Type-C cables can differ greatly in their capabilities.

We recommend a cable that is certified 'Certified USB' and 'DP8K', supports 'SuperSpeed USB 10Gbps' and 'USB-PD', contains an 'E-Mark' chip and is rated for up to 5A, has a USB Type-C connector on both ends, and is no longer than 1m.

| Goal | Requirement |
|---|--|
| Provide a video signal to USB Type-C port 1 | <p>Certification: Use a cable that is certified 'DP8K'.</p> <p>Connectors: The cable can have a USB Type-C connector on both ends, or can have a USB Type-C connector on the monitor side and a DisplayPort connector on the computer side.</p> <p>Speeds: A cable that is certified 'DP8K' will provide support for all the benefits of DisplayPort 1.4. It will enable Spectrum's maximum resolution, refresh rate, and color depth, and support all its features.</p> <p>Cables of higher certification, such as 'DP40' or 'DP80', will also support all the benefits of DisplayPort 1.4.</p> <p>A cable that is not VESA-certified may only offer support for DisplayPort 1.2 and may not support features such as Display Stream Compression (DSC) and High Dynamic Range (HDR).</p> <p>Spectrum can operate its ports in DisplayPort 1.2 mode, if your computer supports DisplayPort 1.4 but you must use an uncertified cable.</p> |

Connect a computer to the built-in USB hub

Certification:

Use a cable that is certified 'Certified USB'.

Connectors:

The cable can have a USB Type-C connector on both ends, or can have a USB Type-C connector on the monitor side and a USB Type-A connector on the computer side.

Speeds:

A cable that supports 'SuperSpeed USB 10Gbps' (also known as 'SuperSpeed+' or 'USB 3.1 Gen 2') will allow data transfer at the built-in hub's maximum speed of up to 10Gbps.

Cables of higher specification, such as 'USB 3.2 Gen 2x2', 'USB4', 'Thunderbolt 3', or 'Thunderbolt 4', will also allow a full speed connection to the built-in USB hub.

A cable that only supports 'SuperSpeed USB' (also known as 'USB 3.0' or 'USB 3.1 Gen 1') will only allow data transfer at up to 5Gbps.

A cable that only supports 'Hi-Speed USB' (also known as 'USB 2.0') will only allow data transfer at up to 480Mbps.

Provide power to a device connected to USB Type-C port 1

Specification:

Use a cable that supports 'USB Power Delivery' (USB-PD) version 2.0 or higher.

Connectors:

The cable must have a USB Type-C connector on both ends.

Speeds:

An 'E-Mark' (Electronically Marked Cable) chip is required to charge at Spectrum's full speed. This chip helps the monitor and your connected device determine their highest supported power transfer speed and contains important over-current and overload protections.

A cable that contains an 'E-Mark' chip and that is rated for up to 5 Amperes of current is required to charge at up to 100W.

A cable that does not contain an 'E-Mark' chip and/or is rated only for up to 3 Amperes of current, will only allow charging at up to 60W.

A cable that is rated for a lower current may offer limited or no charging capabilities.

Solving common problems

The following table lists possible problems, the possible cause of each problem, and the recommended solutions.

| Problem | Possible cause | Solution |
|---|---|---|
| Screen is blank. | Power cord is disconnected. | Connect the monitor power cord. |
| | Monitor is off. | Press the monitor power button  . |
| Screen is blank, or 'No signal' is displayed on the screen. | Monitor video cable is disconnected. | Connect the appropriate video cable between the computer and monitor. Be sure that the computer power is off while you connect the video cable. |
| | The monitor is set to the wrong input. | Press joystick down to switch video inputs, until a valid signal is found. |
| | System is in sleep mode. | Press any key on the keyboard or move the mouse to exit sleep mode. |
| Screen is blank, or 'Signal out of range' is displayed on screen. | System is powered off | Press the system's power button. |
| | Video resolution and/or refresh rate are set higher than what the monitor supports. | Change the settings to a supported setting. |
| Screen is blank, or video is flashing. | Video card is incompatible. | Replace the video card or connect the video cable to one of the computer's onboard video sources. |
| Image appears too dark. | Brightness setting is too low. | Open the OSD menu and select 'Brightness' in the 'Picture' menu to adjust the brightness scale as needed. |

Updating firmware

Spectrum features user-upgradable firmware. Updating the firmware may resolve issues and may improve or add new features.

You can download the latest firmware updates from the Downloads section of our support page at <https://www.dough.tech/pages/downloads>. Special instructions may be included, so keep an eye out for **instructions.pdf**.

Firmware is a specific class of software that provides low-level control for the device's specific hardware. Unlike device drivers which are stored on your computer's system drive, firmware is stored on the chips in the device itself. Though it rarely needs to be updated, firmware updates can improve system security, performance, or stability, and can in some cases even add new functionality.



IMPORTANT

Because firmware updates are written to non-volatile storage inside the monitor, there is a certain risk involved when installing them. Despite built-in failsafe- and recovery features, (a part of) Spectrum may not function properly if the update process is interrupted. Therefore, you should always make sure your monitor is connected to a reliable power source, and that you dedicate enough time to this process before you begin.

The documentation that comes with each firmware update lists the changes it enacts. We recommend to only install firmware updates if you are experiencing issues with the affected features or intend to use the new features it adds.

Installing firmware updates is always done at your own risk!

Take careful note of your monitor's model number, and only use firmware files that are specifically developed for your exact model. Using firmware developed for a different model may cause (a part of) Spectrum to not function properly.

Always cross-check the model number of your monitor with the models listed in the firmware update's documentation! If you are uncertain about which firmware file is right for your monitor, please contact our support team at <https://www.dough.tech/pages/support>.

Some new features were introduced through firmware updates. The following table lists certain features that may require a firmware update before you can use them on your monitor. Alongside each feature, the firmware version is listed that your Spectrum model requires to use them.

| feature | model ES07D03 | model ES07DC9 | model ES07E30 |
|---|------------------|------------------|------------------|
| Phase control and other precise backlight strobe settings | 104 and up | all | all |
| Display stream compression (DSC) over USB Type-C | 107 and up | all | all |
| DisplayPort 1.2 mode and DisplayPort 1.4 mode without display stream compression (DSC), over DisplayPort and USB Type-C | 108 and up | 101 and up | all |
| Variable refresh rates on PlayStation 5 | 107 and up | all | all |
| Split-screen mode | 106 and up | all | all |
| Crosshair styles (Cross and Eve) | 102 and up | all | all |
| Crosshair color options (red and black) | 102 and up | all | all |
| Crosshair color options (dark grey, medium grey, light grey, green, blue, cyan, magenta, and yellow) | 108 and up | 101 and up | all |
| Crosshair adjustable from the OSD menu | 108 and up | 101 and up | all |
| Frame rate counter color options (black, dark grey, medium grey, light grey, white, green, blue, cyan, magenta, and yellow) | 108 and up | 101 and up | all |
| Quick action to change video input source (joystick down) | 106 and up | all | all |
| Quick action to change USB hub source (joystick up) | 106 and up | all | all |
| Individual port bindings for USB hub auto-switching | 108 and up | all | All |
| OSD and control rotation for portrait mode | 104 and up | all | all |
| 'Bottom center' position option for the OSD | 108 and up | 101 and up | all |

Contacting support

If you cannot solve a problem using the troubleshooting tips in this section, you may need to contact technical support at <https://www.dough.tech/pages/support>. Have the following information available when you contact Dough:

- Monitor model number
- Monitor serial number
- Purchase date on invoice
- Conditions under which the problem occurred
- Any error messages received
- Your hardware configuration
- Name and version of the software you are using

Locating the model and serial number

The serial number and product number are located on a label on the rear of the monitor. You may need these numbers when contacting Dough about your issue.

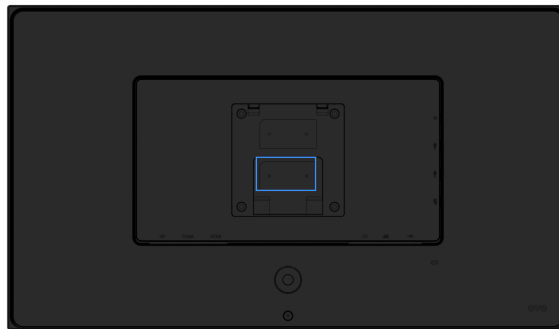

The model number is a seven-digit alphanumeric code starting with 'ES'.

The serial number is a twelve-digit alphanumeric code starting with 'EVE'.



NOTE

You may need to remove the Spectrum Stand or VESA mount to read the label.

Model ES07DC9 may have its model number listed as 'ES07D03/07DC9'.

Model ES07E30 may have its model number listed as 'ES07D03/07E30'.

Maintaining the monitor

Maintenance guidelines

To enhance the performance and extend the life of the monitor:

- When installing or removing the Spectrum Stand or a VESA mount, position the monitor face-down on a soft area to prevent it from getting scratched, defaced, or broken.
- Turn the monitor off when not in use. You can substantially increase the life expectancy of the monitor by using a screen saver program and turning off the monitor when not in use.



NOTE

Spectrum uses In-Plane Switching (IPS) display technology which provides ultrawide viewing angles and advanced image quality, making it suitable for a wide variety of advanced image quality applications. This panel technology, however, is not suitable for applications that exhibit static, stationary, or fixed images for long periods of time without the use of screen savers. These types of applications may include camera surveillance, marketing logos, and templates that are displayed on the screen for a prolonged period.

Displaying the same static image or image elements on the screen for multiple consecutive hours may cause image retention damage that could look like stains or watermarks on the monitor's screen. Image retention (also called 'burn-in') is a condition that may occur on all LCD screens. To avoid image retention damage, either turn off the monitor when it is not in use or use the power management setting, if supported on your system, to turn off the monitor when the system is idle.

- Do not open the monitor cabinet or attempt to service this product yourself. Adjust only those controls that are covered in the operating instructions.
- If the monitor is not operating properly or has been dropped or damaged, contact an authorized Dough dealer, reseller, or service provider. This includes situations where:
 - the power cord or plug is damaged, cut or frayed;
 - liquid was spilled into the product;
 - the product was exposed to rain or water;
 - the product has been dropped or the housing has been damaged;
 - the product exhibits a distinct change in performance; or
 - the product does not operate normally after following the operating instructions.
- Disconnect the monitor by grasping the plug firmly and pulling it from the AC outlet. Never disconnect the monitor by pulling the cord.
- Slots and openings in the cabinet are provided for ventilation. These openings must not be blocked or covered. Never push objects of any kind into cabinet slots or other openings, or spill liquid of any kind onto or into the product.
- Keep the monitor in a well-ventilated area, away from excessive light, heat, or moisture.

Cleaning

1. Turn off the monitor and unplug the power cord from the AC outlet.
2. Dust the monitor by wiping the screen and the cabinet with a soft, clean antistatic cloth, for example microfiber.
3. When dealing with more than dust, use a cleaning solution specifically designed for LCD panels to dampen your cloth. Wipe the screen gently and in small circles avoiding pressure.



IMPORTANT

Never spray the cleaning solution directly on the device, as it may run behind the bezel and damage the electronics.

4. For more difficult cleaning situations, use a 50/50 mix of water and isopropyl alcohol to dampen your cloth. Wipe the screen gently and in small circles avoiding pressure.



IMPORTANT

Never spray the cleaning solution directly on the device, as it may run behind the bezel and damage the electronics.

Do not use cleaners that contain any petroleum-based materials such as benzene, thinner, or any volatile substance to clean the monitor screen or cabinet. These chemicals may damage the monitor and cause permanent discoloration.

5. Make sure the screen and housing are completely dry before using the monitor again.

Shipping

Keep the original packing box in a storage area. You may need it later if you wish to move or ship the monitor.

Disposal



Spectrum was built to bring you joy for years. Should the day come that it is time to discard it, do not throw this electronic device into the trash. To minimize pollution and ensure the protection of our global environment, please recycle. If everything still works, consider giving it a new life on the desk of a friend or family member. Thank you for doing your part to keep our planet safe!

Technical specifications

For the latest specifications or additional specifications on this product, go to <https://www.dough.tech/products/spectrum-4k-144hz> and click *Specs*.



NOTE

All specifications represent the typical specifications provided by Dough's component manufacturers; actual performance may vary either higher or lower.

Display

Size

| | |
|--------------|----------------|
| monitor size | 27" (diagonal) |
| display area | 597x336mm |
| aspect ratio | 16 : 9 |

Image quality

| | |
|--------------------|---|
| native resolution | 3840x2160 pixels 4K Ultra-HD |
| pixel pitch | 0.1557mm |
| pixel density | 163ppi |
| brightness | 450cd/m ² typical 750cd/m ² peak |
| HDR | HDR10 Media Profile VESA DisplayHDR600 certified |
| displayable colors | 1.07 billion |
| color gamut | 98% DCI-P3 100% sRGB |
| color depth | 10-bit (8-bit + A-FRC) |
| color accuracy | Individual factory calibration D65 white point, average $\Delta E < 1$ (typical) |
| contrast ratio | 1000 : 1 typical 10 000 000 : 1 dynamic |
| viewing angles | 178° horizontal 178° vertical |
| surface treatment | Low-haze anti-glare matte coating (model ES07D03) Low-haze anti-reflective glossy coating (model ES07DC9) Corning Gorilla Glass 3 with DXC anti-reflective treatment (model ES07E30) |

Speed

| | |
|-----------------|---|
| response time | 5ms (gray-to-gray) typical 1ms (gray-to-gray) overdrive |
| frequency range | 48 – 144Hz |
| adaptive sync | VESA AdaptiveSync Display certified NVIDIA G-SYNC Compatible certified AMD FreeSync Premium Pro certified |

Technology

| | |
|----------------------|---|
| panel technology | Nano IPS Oxide TFT LCD |
| backlight technology | Bottom edge-lit white LED with KSF nano-particle layer Flicker free backlight without pulse-width modulation (PWM) |
| backlight dimming | No dynamic dimming in SDR mode 16-zone local dimming in HDR mode |
| curved panel | No |
| touch-enabled | No |
| pen-enabled | No |

Ports

Video input

| | |
|------------------|---|
| HDMI (2x) | HDMI 2.1 video input with 48Gbps of bandwidth, and support for: <ul style="list-style-type: none"> - enhanced display data channel (E-DDC); - HDR10 media profile; - variable refresh rate (VRR); and - high-bandwidth digital content protection (HDCP) 2.2 |
| DisplayPort (1x) | DisplayPort 1.4 video input with support for: <ul style="list-style-type: none"> - high bit rate 3 (HBR3) transmission mode; - display stream compression (DSC) 1.2; - enhanced display data channel (E-DDC); - HDR10 media profile; - variable refresh rate (VRR); and - high-bandwidth digital content protection (HDCP) 2.2 |
| USB Type-C (1x) | DisplayPort 1.4 video input with support for: <ul style="list-style-type: none"> - high bit rate 3 (HBR3) transmission mode; - display stream compression (DSC) 1.2; - enhanced display data channel (E-DDC); - HDR10 media profile; - variable refresh rate (VRR); and - high-bandwidth digital content protection (HDCP) 2.2 SuperSpeed+ USB (USB 3.1 Gen 2, up to 10Gbps) upstream connection to computer Power output up to 20V --- 5A (100W) (USB PD 3.0) |

USB hub

| | |
|--------------------------|--|
| USB Type-C (1x) | SuperSpeed USB 10Gbps (USB 3.1 Gen 2, up to 10Gbps) Power output up to 5V --- 3A (15W) |
| USB Type-A (2x) | SuperSpeed USB 10Gbps (USB 3.1 Gen 2, up to 10Gbps) Power output up to 5V --- 2A (10W) |
| USB Type-B upstream (1x) | SuperSpeed+ USB (USB 3.1 Gen 2, up to 10Gbps) upstream connection to computer (In addition to the USB Type-C port with video input) |

Audio

| | |
|-------------------------|---|
| 3.5mm audio output (1x) | Analog audio output from video input source |
|-------------------------|---|

Features

Adjustable **Backlight strobing** reduces eye-tracking motion blur and increases the clarity of objects that move quickly across the screen.

Adjustable **Overdrive** lets you balance high-speed performance and image quality to best suit your needs.

The **Pre-sets** have been tuned by Blur Busters for great performance straight out of the box.

A **Crosshair overlay** assists your aim and gives a competitive advantage.

A **Frame counter overlay** shows you how well your system performs and helps pick the right settings for any game.

Pixel-perfect upscaling, using integer-ratio pixel duplication for low-resolution input signals, maintains the iconic look of pixel art and keeps retro games looking crisp.

The **USB Type-C port** lets you connect the monitor and its built-in USB hub to your mobile device with a single cable while also charging it at up to 100W.

Split-screen mode places the screens from two computers side-by-side so you can keep an eye on everything at once.

User-upgradable firmware allows development to continue based on customer feedback, to tweak existing features and unlock new ones.

| | |
|------------------------|---|
| monitor mount support | Yes, VESA Mounting Interface Standard 100x100mm |
| security cable support | Yes, Kensington lock compatible |
| built-in speakers | No |

Adjustment

| | |
|---------------|--|
| controls | 1x Power button 1x 5-Way joystick Controls are centered on the back of the monitor |
| status light | 1x Power indicator light User-adjustable behavior and color (Default: solid white when on, pulsing white in standby) |
| OSD languages | English, Chinese, French, German, Japanese, Spanish |

Stand

| | |
|----------------------------|--------------------------------|
| material | Cast aluminum alloy |
| vertical tilt | 7° down, 23° up |
| horizontal swivel | No |
| pivot / landscape rotation | 90° left, 90° right |
| height adjust | 122mm |
| removable | Yes, with quick-release button |



NOTE

The Dough Spectrum Stand (ES07D04) is sold separately.

Size and weight

| | |
|---|--|
| dimensions, monitor with stand (WxHxD) | 607x571x227mm landscape, highest 607x449x227mm landscape, lowest 351x707x227mm portrait, highest 351x617x227mm portrait, lowest |
| dimensions, monitor only (WxHxD) | 607x351x44mm 696x446x137mm with box |
| dimensions, stand only (WxHxD) | 200x430x227mm 532x212x135mm with box |
| weight, monitor with stand | 7.0kg |
| weight, monitor only | 5.0kg 8.2kg with box |
| weight, stand only | 2.0kg 3.0kg with box |

Electrical and operating requirements

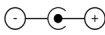
| | |
|----------------------|---|
| operating conditions | 0 – 35°C 20 – 80% RH |
| storage conditions | -20 – 60°C 20 – 80% RH |
| power consumption | 59W typical 222W maximum 0.49W standby |
| power input | 19.5V $\overline{=}$ 11.8A  |
| power supply type | External power adapter |
| power supply input | 110 – 240V \sim 3.5A 50 – 60Hz |

Limited warranty

3 years limited warranty
'Zero bright dot' pixel policy



NOTE

For warranty details or instructions, please refer to the warranty policy available on <https://www.dough.tech/pages/dough-spectrum-limited-warranty>

In the box

Dough Spectrum
Power adapter
Power cable
Quick start guide
Color calibration report