

ULTIMEA

Dolby Atmos

HDMI™
HIGH DEFINITION MULTIMEDIA INTERFACE

Bluetooth®



User Manual

Nova S70

EN: User Manual

FR: Manuel de l'Utilisateur

DE: Benutzerhandbuch

IT: Manuale d'uso

JP: ユーザーマニュアル

ES: Manual del usuario

Model No.: U3920

Nova S70 3.1.2 Channel Dolby Atmos Soundbar

Contents

01	User Manual	English
	Connection and Installation	02
06	Benutzerhandbuch	Deutsch
	Anschluss und Installation	07
11	ユーザーマニュアル	日本語
	接続と設置	12
16	Mode d'Emploi	Français
	Raccordement et installation	17
21	Manuale d'uso	Italiano
	Connessione e installazione	22
26	Manual del usuario	Español
	Conexión e instalación	27

User Manual

WE ARE
READY
TO HELP



support@ultimea.com



Model No.: U3920

Prefer video tutorial?

Setup guidance video, or USER MANUAL on ULTIMEA website.

@ultimea_official



support.ultimea.com

+1 888-598-8875 (US) Mon-Fri 9am-5pm (PST)
 +49 89-628-25828 (EU) Mon-Fri 9am-5pm (CET)

1 ACCESSORIES LIST

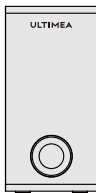

Subwoofer



Soundbar



Power Adaptor

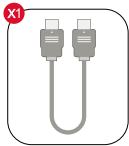

HDMI Cable

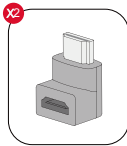

HDMI Adaptor

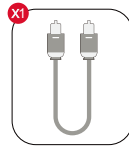

Digital Optical Cable

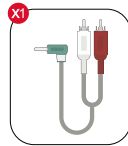

Stereo 3.5mm to RCA Audio Cable

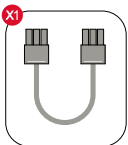

6-pin Cable for Soundbar Connection (140mm)



Remote Control

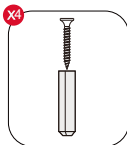

Wall Mounted Kit

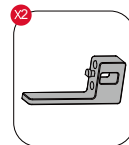

Wall Bracket



User Manual

2 SOUNDBAR CONTROLS

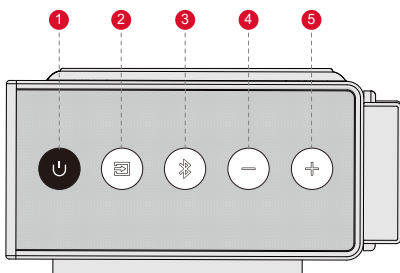

Control Panel

- 1 **“⏻”**: **Power Button**
Press to power on / Hold for 3 seconds to power off.
- 2 **“📺”**: **Input Mode**
Press to switch channels: eARC-HD IN (HDMI IN)-OPT (OPTICAL)-BT-AUX-USB.
- 3 **“📶”**: **BT**
Press to switch to Bluetooth channel and enter pairing mode. Hold for 3 seconds to disconnect the current device and connect to a new device manually on your mobile phone / PC / TV (BT ID: Nova S70).
- 4 **“—”**: **Volume Down**
- 5 **“+”**: **Volume Up**

Remote Control

- 1 "⏻": **Power Button**
Press to power on / Hold for 3 seconds to power off.
- 2 "eARC": **eARC**
Press to switch to HDMI eARC channel.
- 3 "HD IN": **HD IN**
Press to switch to HDMI IN channel.
- 4 "OPT": **OPT**
Press to switch to OPTICAL channel.
- 5 "BT": **BT**
Press to switch to Bluetooth channel and enter pairing mode.
Hold for 3 seconds to disconnect current device and connect to a new device manually on your mobile phone / PC / TV (BT ID: Nova S70).
- 6 "EQ": **EQ**
Press to switch among Movie, Dialogue, Music mode, the display will show: "MOVIE", "DIALOG", "MUSIC".
- 7 "INPUT": **INPUT**
Press to switch channels: eARC-HD IN (HDMI IN)-OPT (OPTICAL)-BT-AUX-USB.
- 8 "+": **Volume Up**
- 9 "-": **Volume Down**
- 10 "<": **Previous**
For BT and USB mode only: Skip to previous track.
- 11 ">": **Next**
For BT and USB mode only: Skip to next track.
- 12 "▶||": **Play / Pause**
For BT and USB mode only.
USB mode: Hold for 3 seconds to switch between single loop playback and list loop playback.
- 13 "Dolby ATMOS": **Dolby Atmos**
Press to adjust upward-firing sound level, the display will show: "AT 1", "AT 0", "AT -1".
- 14 "BASS MAX": **BASSMAX**
Press to adjust bass level, the display will show: "B5-2", "B5-1", "B5 0", "B5 1", "B5 2".
- 15 "🔇": **Mute / Recover the volume.**

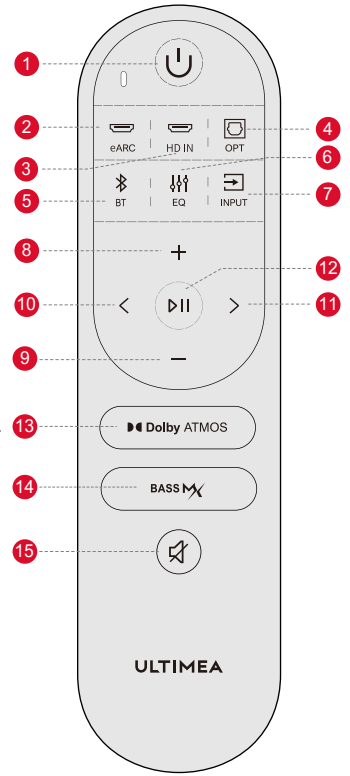

3 SOUNDBAR INSTALLATION

Assembly Steps

Step 1

Set the two parts of the Soundbar on the same level and align the connection joints. Connect the two parts by pushing parallelly to combine as one piece.

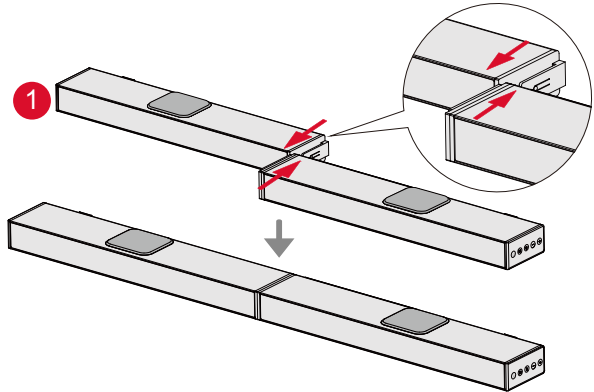

Step 2

Plug in 6pin Cable.

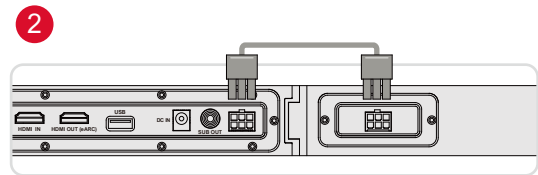

4 CONNECT TO SUBWOOFER

EN

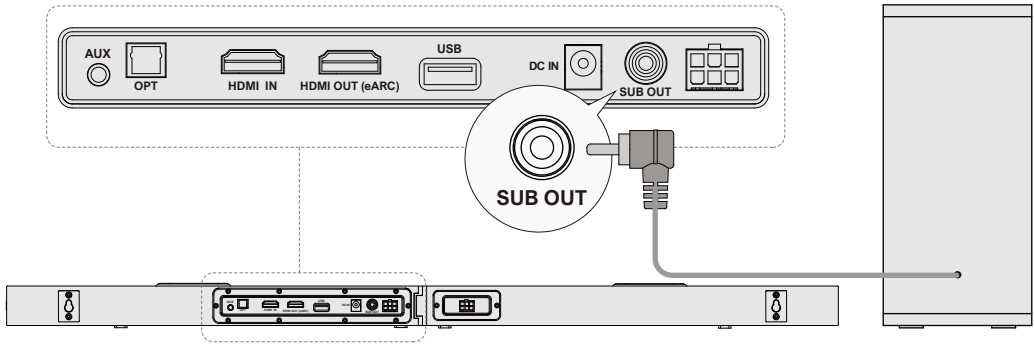

5 CONNECT TO TV VIA HDMI OUT eARC / ARC

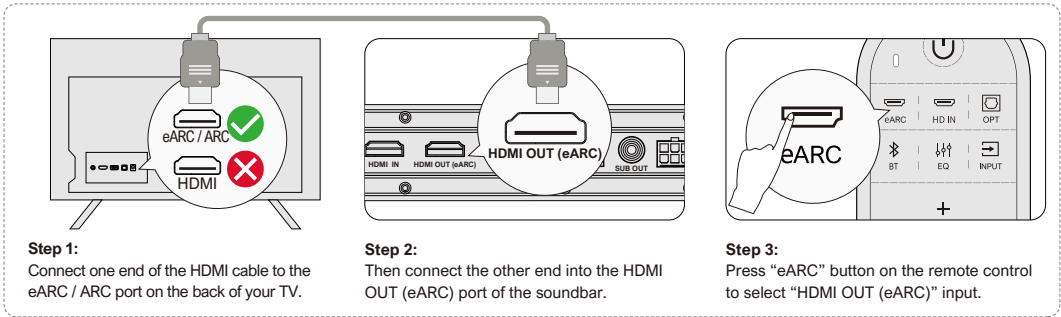

Note:

Make sure your TV HDMI supports eARC, otherwise the Dolby Atmos audio signal cannot be transmitted.

Atmos: If you are watching a movie in the Dolby Atmos format, please set the audio output on your TV to Pass Through:
TV Settings > Home > Settings > Sound > Digital Audio Output > Pass Through

DTS: If you are watching a movie in the DTS format, please set the audio output on your TV to PCM:
TV Settings > Home > Settings > Sound > Digital Audio Output > PCM

What's the difference between: HDMI IN, HDMI ARC, HDMI eARC?

HDMI IN is a standard HDMI input that allows you to connect devices to your TV or audio system. It supports audio and video signals, but it does not support audio return channel (ARC) or enhanced audio return channel (eARC) functionality.

HDMI ARC is a special HDMI port that supports two-way communication between your TV and audio system. This means that audio can be sent from your TV to your audio system, and audio system can send audio back to your TV.

HDMI eARC (Enhanced Audio Return Channel) is an updated version of HDMI ARC that supports higher quality audio formats such as Dolby Atmos and DTS:X.

Note: Please turn on the "CEC" function on your TV.

When eARC / ARC is connected, your TV remote control can control the soundbar and TV simultaneously:

- 1 Turn on / off
- 2 Adjust the volume

6 CONNECT TO OTHER DEVICE VIA HDMI IN

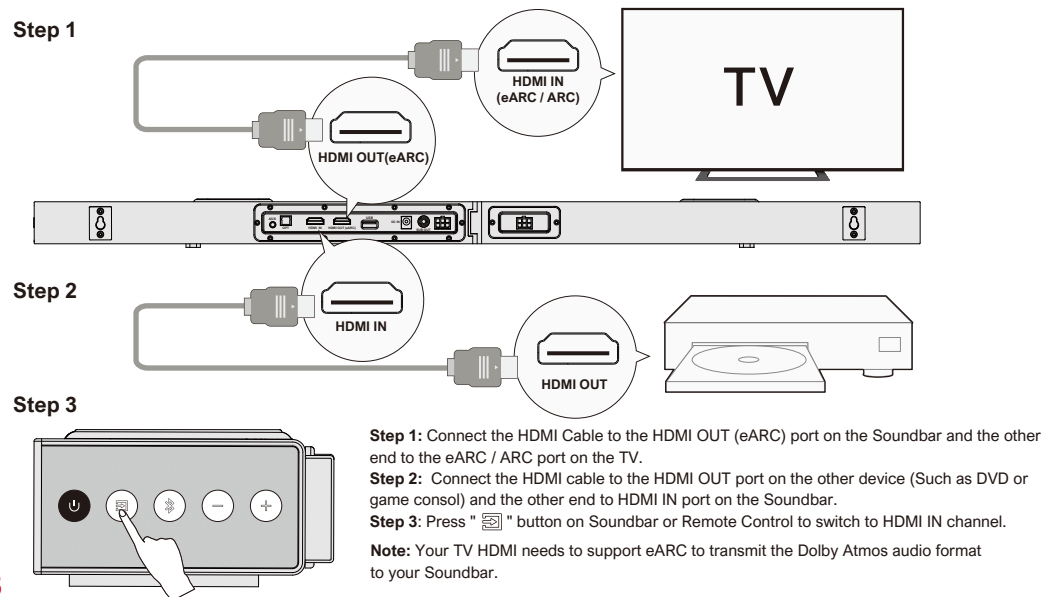

Step 1: Connect the HDMI Cable to the HDMI OUT (eARC) port on the Soundbar and the other end to the eARC / ARC port on the TV.

Step 2: Connect the HDMI cable to the HDMI OUT port on the other device (Such as DVD or game console) and the other end to HDMI IN port on the Soundbar.

Step 3: Press "HDMI IN" button on Soundbar or Remote Control to switch to HDMI IN channel.

Note: Your TV HDMI needs to support eARC to transmit the Dolby Atmos audio format to your Soundbar.

7 CONNECT TO TV VIA OPTICAL / AUX

EN

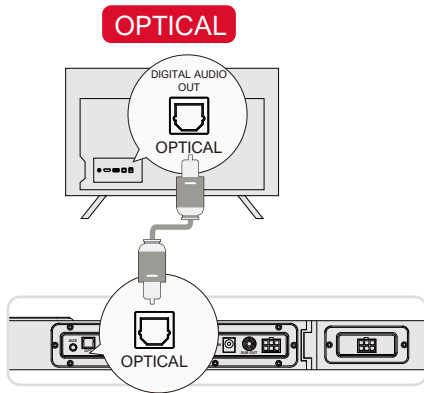

OPTION 1: OPTICAL

- 1 Make sure the cable is connected to OPTICAL OUT port on your TV, and the other end to OPTICAL port on the Soundbar.
- 2 Make sure the optical plug is inserted correctly as it shows in the picture. Do not insert the plug upside down and break the optical.

Note: If audio is coming from the internal TV speakers, mute or minimize the TV volume.

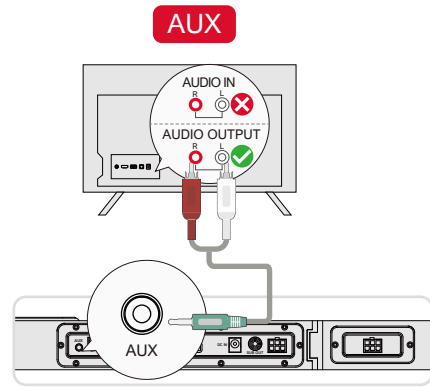

OPTION 2: AUX

- 1 Connect the 3.5mm to RCA audio cable to connect to your TV's RCA AUDIO OUT port.
- 2 Make sure the color of the cables ends matches the color of the TV ports.

Note: Please remember to unplug the AUX cable from TV and Soundbar when you want to switch other mode.

In Optical Mode: If there is no sound, try setting the TV audio output to PCM: TV Settings > Home > Settings > Sound > Digital Audio Output > PCM

8 CONNECT TO BLUETOOTH®

- 1 Press the "Bluetooth" button on the soundbar or remote control to enter Bluetooth pairing mode.
- 2 Open your phone's Bluetooth settings, find and select "Nova S70" to connect the soundbar.

Note: If it's already in the Bluetooth mode and connected, press and hold "Bluetooth" button for 3 seconds to disconnect current device and connect to new device manually on your mobile phone / PC / TV.

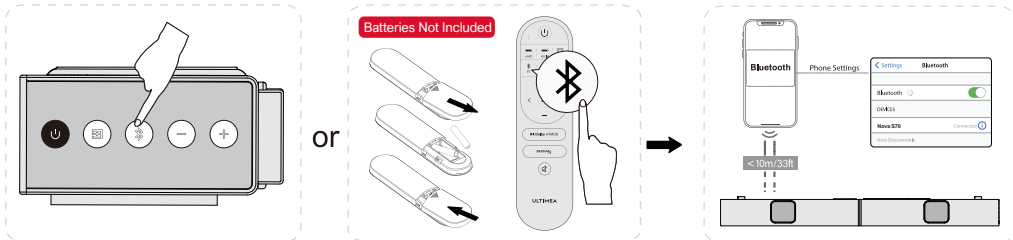

9 PLACEMENT OPTIONS

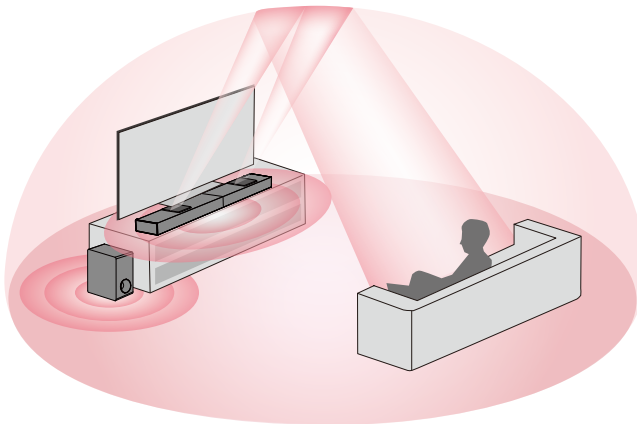

Note: The soundbar should be placed at or near ear level.

10 WALL MOUNT INSTALLATION

EN

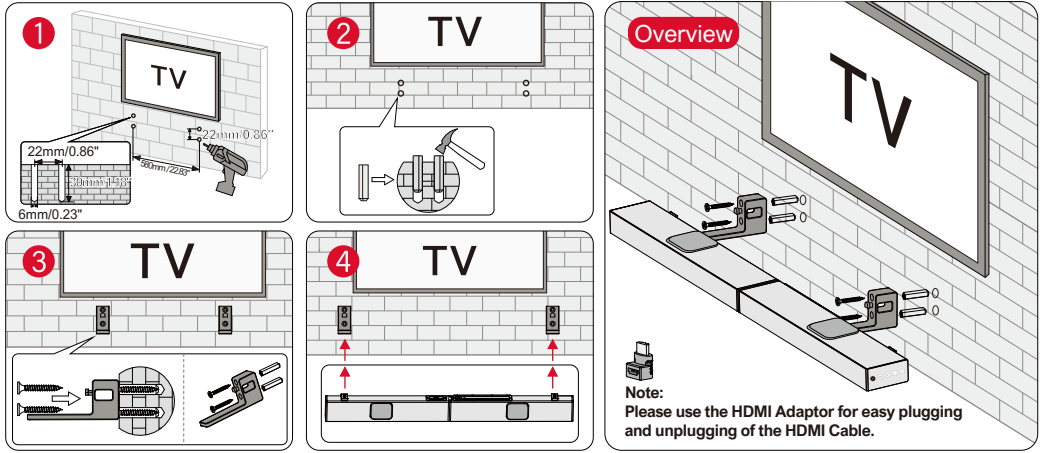

11 SPECIFICATIONS

Model Number	U3920
Power Supply	AC 100-240V, ~50 / 60Hz
Soundbar Drivers	(3.1" x 1.2") x 3 (Soundbar) + 1.8" x 2 (upward-firing Driver) + 2.25" (Subwoofer)
Frequency Response	45Hz - 18kHz
Standby Power	<0.5W
Operating Temperature	0°C - 45°C / 32°F - 113°F
Bluetooth Version	5.3

Dimensions and Weight		
Soundbar	800(W) x 38(H) x 90(D)mm	31.5" x 1.5" x 3.5"
Subwoofer	270(W) x 115(H) x 270(D)mm	10.6" x 4.5" x 10.6"
Packaging	332(W) x 432(H) x 190(D)mm	13.1" x 17" x 7.5"
Net Weight	4.15kg / 9.15lbs	
Gross Weight	5.1kg / 11.24lbs	

ULTIMEA

Nova S70

Benutzerhandbuch



Modell Nr.: U3920

WIR SIND BEREIT ZU HELFEN



support@ultimea.com

DE

Bevorzugen Sie ein Video-Tutorial?

Setup-Anleitung Video, oder
USER MANUAL auf ULTIMEA
Website.

@ultimea_official



support.ultimea.com

+1 888-598-8875 (US) Mon-Fri 9am-5pm (PST)
+49 89-628-25828 (EU) Mon-Fri 9am-5pm (CET)

1 ZUBEHÖRLISTE

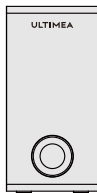

Subwoofer



Soundbar



Netzadapter

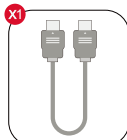

HDMI-Kabel

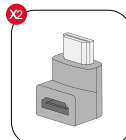

HDMI-Adapter

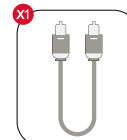

Optisches Digitalkabel

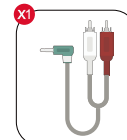

Stereo 3.5mm auf RCA
Audiokabel

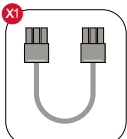

6-pin Kabel für
Soundbar-Anschluss (140mm)



Fernbedienung

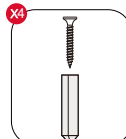

Wandmontage-Kit

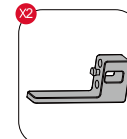

Wandhalterung



Benutzerhandbuch

2 SOUNDBAR-BEDIENELEMENTE

Bedienfeld

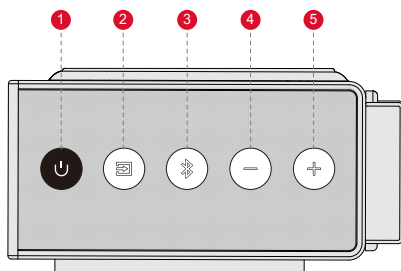

1 “⏻”: **Einschalttaste**

Zum Einschalten drücken / zum Ausschalten 3 Sekunden lang gedrückt halten.

2 “📺”: **Eingangsmodus**

Drücken, um den Kanal zu wechseln: eARC-HD IN (HDMI IN)-OPT (OPTICAL)-BT-AUX-USB.

3 “📶”: **BT**

Drücken Sie , um zum Bluetooth-Kanal zu wechseln und den Kopplungsmodus zu aktivieren. Halten Sie die Taste 3 Sekunden lang gedrückt, um die Verbindung mit dem aktuellen Gerät zu trennen und sich manuell mit einem neuen Gerät auf Ihrem Mobiltelefon / PC / Fernseher zu verbinden. (BT ID: Nova S70).

4 “-”: **Lautstärke verringern**

5 “+”: **Lauter**

Fernsteuerung

- 1 "U": **Einschalttaste**
Zum Einschalten drücken / zum Ausschalten 3 Sekunden lang gedrückt halten.
- 2 "eARC": **eARC**
Drücken, um zum HDMI eARC-Kanal zu wechseln.
- 3 "HD IN": **HD IN**
Drücken, um zum HDMI IN-Kanal zu wechseln.
- 4 "OPT": **OPT**
Drücken, um zum OPTICAL-Kanal zu wechseln.
- 5 "BT": **BT**
Drücken Sie , um zum Bluetooth-Kanal zu wechseln und den Kopplungsmodus zu aktivieren. Halten Sie die Taste 3 Sekunden lang gedrückt, um die Verbindung mit dem aktuellen Gerät zu trennen und sich manuell mit einem neuen Gerät auf Ihrem Mobiltelefon / PC / Fernseher zu verbinden. (BT ID: Nova S70).
- 6 "EQ": **EQ**
Drücken Sie diese Taste, um zwischen den Modi Film, Dialog und Musik umzuschalten; auf dem Display wird angezeigt: "MOVIE", "DIALOG", "MUSIC".
- 7 "INPUT": **INPUT**
Zum Umschalten der Kanäle drücken:
eARC-HD IN (HDMI IN) -OPT (OPTICAL)-BT-AUX-USB.
- 8 "+": **Lautstärke aufwärts**
- 9 "-": **Lautstärke runter**
- 10 "<": **Zurück**
BT- und USB-Modus: Zum vorherigen Titel springen.
- 11 ">": **Nächster**
BT- und USB-Modus: Sprung zum nächsten Titel.
- 12 "DII": **Wiedergabe / Pause**
Nur für BT- und USB-Modus.
USB-Modus: Halten Sie die Taste 3 Sekunden lang gedrückt, um zwischen Einzelschleifenwiedergabe und Listenschleifenwiedergabe umzuschalten.
- 13 "Dolby ATMOS": **Dolby Atmos**
Drücken Sie die Taste, um die Lautstärke nach oben zu regeln, auf dem Display erscheint: "AT I", "AT D", "AT - I".
- 14 "BASS MAX": **BASSMAX**
Drücken Sie diese Taste, um den Basspegel einzustellen; auf dem Display wird angezeigt: "BS-2", "BS-1", "BS 0", "BS 1", "BS 2".
- 15 "Mute": **Stummschaltung / Wiederherstellung der Lautstärke.**

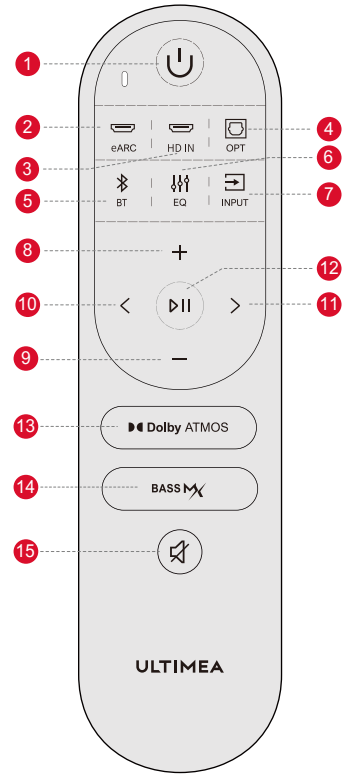

3 SOUNDBAR-INSTALLATION

Montageschritte

Schritt 1

Stellen Sie die beiden Teile der Soundbar auf die gleiche Höhe und richten Sie die Verbindungsstellen aus. Verbinden Sie die beiden Teile durch paralleles Schieben, um sie zu einem Stück zusammenzufügen.

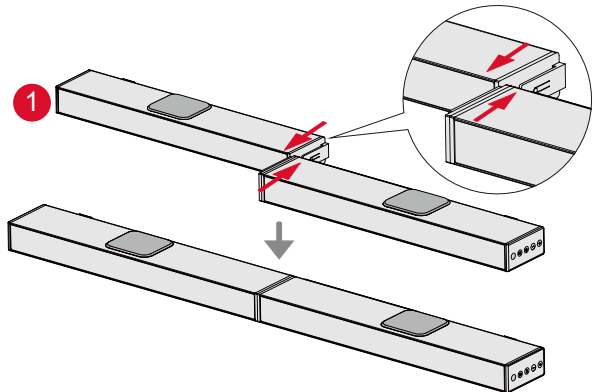

Schritt 2

Stecken Sie Stereo 6-pin kabel.

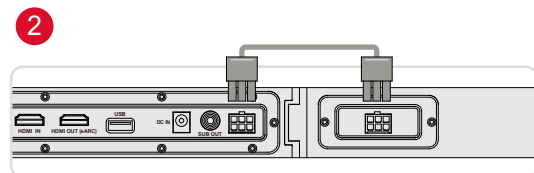

4 ANSCHLUSS AN SUBWOOFER

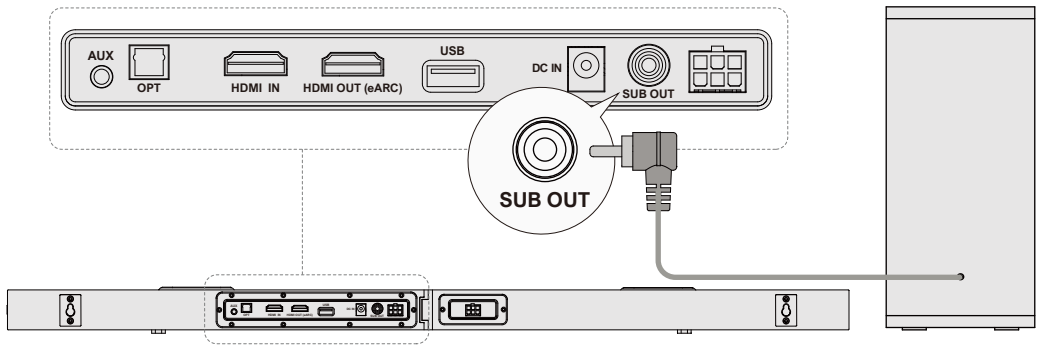

DE

5 ANSCHLUSS AN DEN TV VIA HDMI OUT eARC / ARC

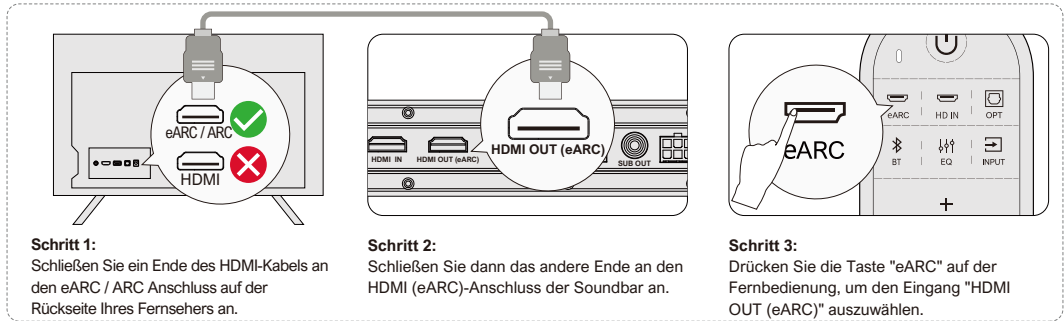

Schritt 1:

Schließen Sie ein Ende des HDMI-Kabels an den eARC / ARC Anschluss auf der Rückseite Ihres Fernsehers an.

Schritt 2:

Schließen Sie dann das andere Ende an den HDMI (eARC)-Anschluss der Soundbar an.

Schritt 3:

Drücken Sie die Taste "eARC" auf der Fernbedienung, um den Eingang "HDMI OUT (eARC)" auszuwählen.

Hinweis:

Der HDMI-Anschluss Ihres Fernsehers muss eARC unterstützen, um das Dolby Atmos-Audioformat an Ihre Soundbar zu übertragen.

Atmos: Wenn Sie einen Film im Dolby Atmos-Format ansehen, stellen Sie bitte den Audioausgang an Ihrem Fernseher auf Pass Through: TV-Einstellungen > Home > Einstellungen > Ton > Digitaler Audioausgang > Pass Through

DTS: Wenn Sie sich einen Film im DTS-Format ansehen, stellen Sie den Audioausgang an Ihrem Fernseher bitte auf PCM: TV-Einstellungen > Home > Einstellungen > Ton > Digitaler Audioausgang > PCM

Was ist der Unterschied zwischen: HDMI IN, HDMI ARC, HDMI eARC?

HDMI IN ist ein Standard-HDMI-Eingang, über den Sie Geräte an Ihren Fernseher oder Ihr Audiosystem anschließen können. Er unterstützt Audio- und Videosignale, aber keine Audio-Rückkanal- (ARC) oder erweiterte Audio-Rückkanal- (eARC) Funktionalität.

HDMI ARC ist ein spezieller HDMI-Anschluss, der die Zwei-Wege-Kommunikation zwischen Ihrem Fernsehgerät und Ihrem Audiosystem unterstützt. Das bedeutet, dass Audiosignale von Ihrem Fernseher an Ihr Audiosystem gesendet werden können und das Audiosystem Audiosignale zurück an Ihren Fernseher senden kann.

HDMI eARC (Enhanced Audio Return Channel) ist eine aktualisierte Version von HDMI ARC, die höherwertige Audioformate wie Dolby Atmos und DTS:X unterstützt.

Hinweis: Bitte schalten Sie die "CEC"-Funktion an Ihrem Fernseher ein.

Wenn eARC / ARC angeschlossen ist, kann Ihre TV-Fernbedienung die Soundbar und den Fernseher gleichzeitig steuern:

- 1 Einschalten / Ausschalten
- 2 Lautstärke einstellen

6 ANSCHLUSS AN EIN ANDERES GERÄT ÜBER HDMI IN

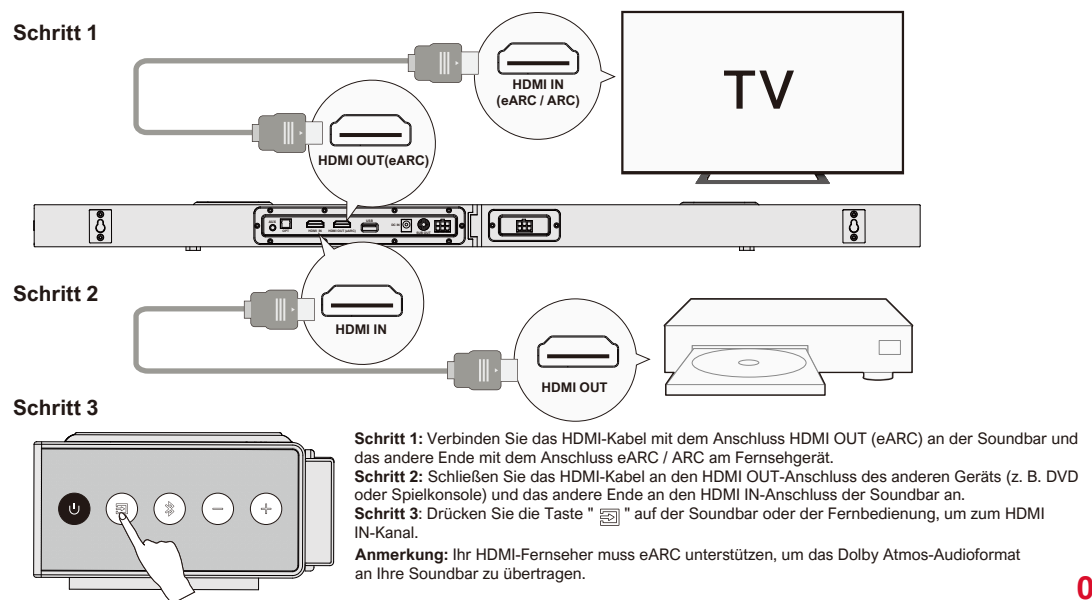

Schritt 1

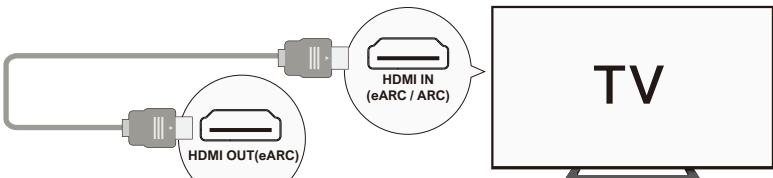

Schritt 2

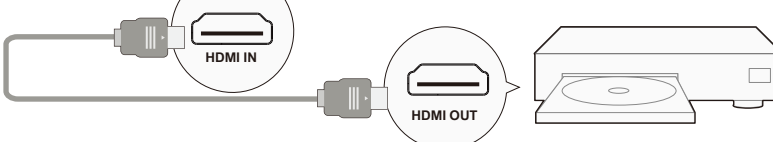

Schritt 3

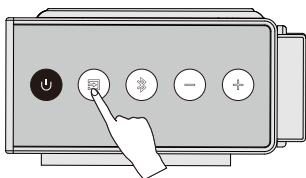

Schritt 1: Verbinden Sie das HDMI-Kabel mit dem Anschluss HDMI OUT (eARC) an der Soundbar und das andere Ende mit dem Anschluss eARC / ARC am Fernsehgerät.

Schritt 2: Schließen Sie das HDMI-Kabel an den HDMI OUT-Anschluss des anderen Geräts (z. B. DVD oder Spielkonsole) und das andere Ende an den HDMI IN-Anschluss der Soundbar an.

Schritt 3: Drücken Sie die Taste "Input" auf der Soundbar oder der Fernbedienung, um zum HDMI IN-Kanal.

Anmerkung: Ihr HDMI-Fernseher muss eARC unterstützen, um das Dolby Atmos-Audioformat an Ihre Soundbar zu übertragen.

7 ANSCHLUSS AN FERNSEHER ÜBER OPTISCH / AUX

DE

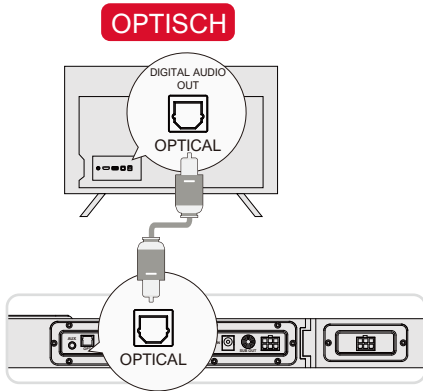

OPTION 1: OPTISCH

- 1 Stellen Sie sicher, dass das Kabel an den OPTICAL OUT-Anschluss Ihres Fernsehers und das andere Ende an den OPTICAL-Anschluss der Soundbar angeschlossen ist.
- 2 Vergewissern Sie sich, dass der optische Stecker richtig eingesteckt ist, wie auf dem Bild zu sehen. Stecken Sie den Stecker nicht verkehrt herum ein, um das optische Kabel nicht zu beschädigen.

Hinweis: Wenn der Ton über die internen TV-Lautsprecher wiedergegeben wird, schalten Sie die Lautstärke des Fernsehers stumm oder verringern Sie sie.

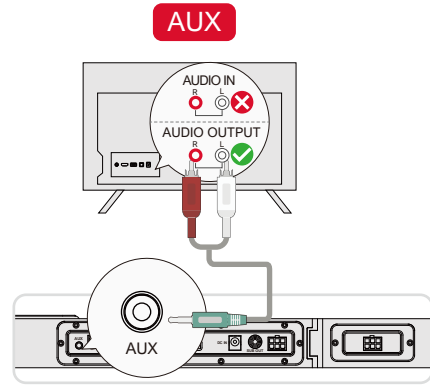

OPTION 2: AUX

- 1 Schließen Sie das 3,5-mm-Cinch-Audiokabel an den RCA-AUDIO OUT-Anschluss Ihres Fernsehers an.
- 2 Achten Sie darauf, dass die Farbe der Kabelenden mit der Farbe der TV-Anschlüsse übereinstimmen.

Hinweis: Bitte denken Sie daran, das AUX-Kabel vom Fernseher und der Soundbar zu trennen, wenn Sie in einen anderen Modus wechseln möchten.

Im optischen Modus: Wenn kein Ton zu hören ist, versuchen Sie, den Audioausgang des Fernsehers auf PCM einzustellen:
TV-Einstellungen > Home > Einstellungen > Ton > Digitaler Audioausgang > PCM

8 MIT BLUETOOTH® VERBINDEN

- 1 Drücken Sie die Taste "⌘" auf der Soundbar oder der Fernbedienung, um den Bluetooth-Kopplungsmodus zu aktivieren.
 - 2 Öffnen Sie die Bluetooth-Einstellungen Ihres Telefons, suchen und wählen Sie "Nova S70", um die Soundbar zu verbinden.
- Hinweis:** Wenn sich das Gerät bereits im Bluetooth-Modus befindet und verbunden ist, halten Sie die Taste "⌘" 3 Sekunden lang gedrückt, um die Verbindung mit dem aktuellen Gerät zu trennen und manuell eine Verbindung mit einem neuen Gerät auf Ihrem Mobiltelefon / PC / Fernseher herzustellen.

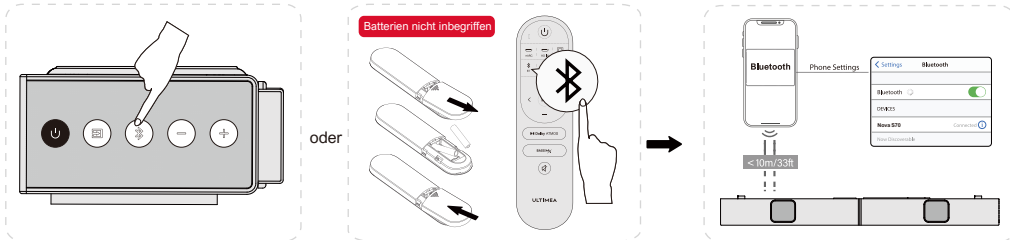

9 PLATZIERUNGSMÖGLICHKEITEN

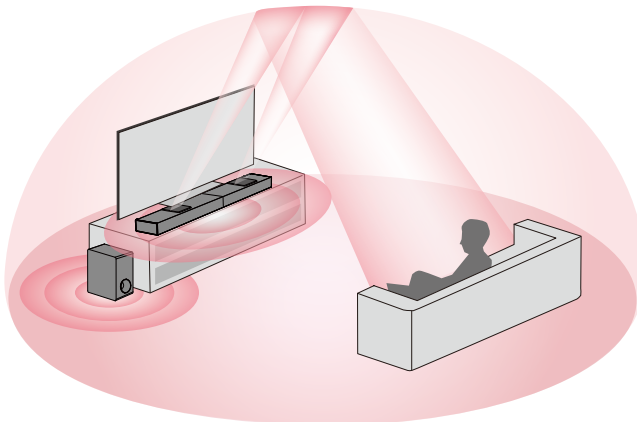

Hinweis: Die Soundbar sollte in Ohrhöhe oder in der Nähe des Ohres aufgestellt werden.

10 WANDBEFESTIGUNG

DE

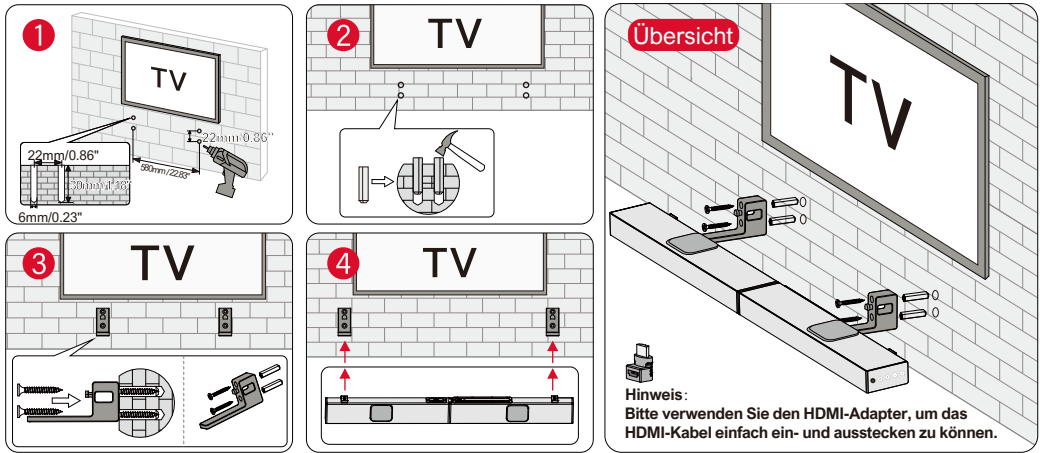

11 SPEZIFIKATIONEN

Modell-Nummer	U3920
Stromversorgung	AC 100-240V, ~50 / 60Hz
Soundbar-Treiber	(3.1" x 1.2") x 3 (Soundbar) + 1.8" x 2 (aufwärts gerichtete Treiber) + 2.25" (Subwoofer)
Frequenzgang	45Hz - 18kHz
Standby-Leistung	<0.5W
Betriebstemperatur	0°C - 45°C / 32°F - 113°F
Bluetooth Vision	5.3

Abmessungen und Gewicht		
Soundbar	800(W) x 38(H) x 90(D)mm	31.5" x 1.5" x 3.5"
Subwoofer	270(W) x 115(H) x 270(D)mm	10.6" x 4.5" x 10.6"
Verpackung	332(W) x 432(H) x 190(D)mm	13.1" x 17" x 7.5"
Nettogewicht	4.15kg / 9.15lbs	
Bruttogewicht	5.1kg / 11.24lbs	

ULTIMEA

Nova S70

JP

ユーザーマニュアル

お手伝い
いたします



support@ultimea.com



モデルNo: U3920

ビデオチュートリアル
をご希望ですか?

セットアップガイドのビデオ、またはULTIMEAウェブサイトのユーザーマニュアルをご覧ください。



@ultimea_official

+1 888-598-8875 (US) Mon-Fri 9am-5pm (PST)
+49 89-628-25828 (EU) Mon-Fri 9am-5pm (CET)



support.ultimea.com

1 アクセサリーリスト



サウンドバー



サブウーファー

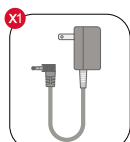

電源アダプター

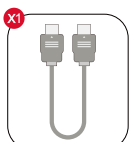

HDMIケーブル

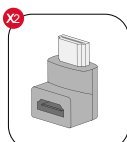

HDMIアダプター

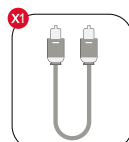

デジタル光ケーブル

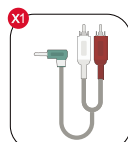

3.5mm-RCAオーディオケーブル

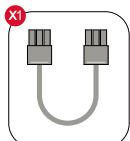

サウンドバー接続用6ピンケーブル(140mm)



リモコン

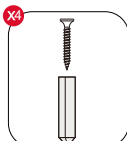

壁掛けネジキット

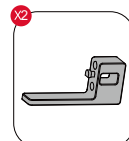

壁掛け固定スタンド



ユーザーマニュアル

2 サウンドバーのコントロール

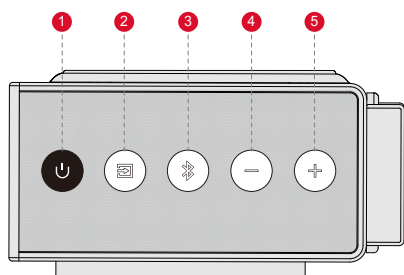

コントロールパネル

- 1 “” : 電源ボタン
押すと電源が入り、3秒間押し続けると電源が切れます。
- 2 “” : 入力モード
押してチャンネルを切り替える: eARC-HD IN (HDMI IN) - OPT (OPTICAL)-BT-AUX-USB.
- 3 “” : BT
を押すとBTチャンネルに切り替わります。(BT ID: Nova S70).
- 4 “” : ボリュームダウン
- 5 “” : 音量アップ

リモコン

- ① “**⏻**” :電源ボタン
電源オン/3秒長押しで電源オフ。
- ② “**eARC**” : eARC
押すとHDMI eARCに切り替えます。
- ③ “**HD IN**” : HD IN
押すとHDMI INに切り替えます。
- ④ “**OPT**” : OPT
押すとOPTICALに切り替えます。
- ⑤ “**BT**” : BT
を押すとBTチャンネルに切り替わります。
(BT ID: Nova S70).
- ⑥ “**EQ**” : EQ
を押して映画、対話、音楽モードを切り替えます:
“**MOVIE**”, “**LOG**”, “**MUSIC**”.
- ⑦ “**INPUT**” : INPUT
を押してチャンネルを切り替えます:
eARC-HD IN(HDMI IN)-OPT(OPTICAL)-BT-AUX-USB.
- ⑧ “**+**” :ボリュームアップ
- ⑨ “**-**” :ボリュームダウン
- ⑩ “**<**” :前
BTおよびUSBモード: 前のトラックにスキップします。
- ⑪ “**>**” :次へ
BTおよびUSBモード: 次のトラックにスキップします。
- ⑫ “**⏮**” :再生/一時停止
USBモード: 3秒間長押しすると、シングルループ再生とリストループ再生が切り替わります。
- ⑬ “**Dolby ATMOS**” :ドルビーアトモス
を押して、上方向のサウンドレベルを調整します:
“**AT 1**”, “**AT 0**”, “**AT -1**” と表示されます。
- ⑭ “**BASSMAX**” : BASSMAX
を押して低音レベルを調整します: “**B5-2**”, “**B5-1**”, “**B5 0**”, “**B5 1**”, “**B5 2**”.
- ⑮ “**🔇**” :音量ミュート/リストア。

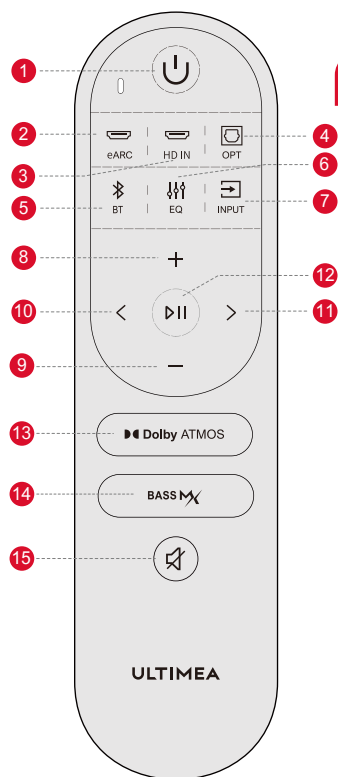

JP

3 サウンドバー設置

組み立て手順

ステップ 1

サウンドバーの2つのパーツを同じ高さにセットし、接続部の位置を合わせます。2つのパーツを平行に押しつけて接続し、1つのパーツとして組み合わせます。

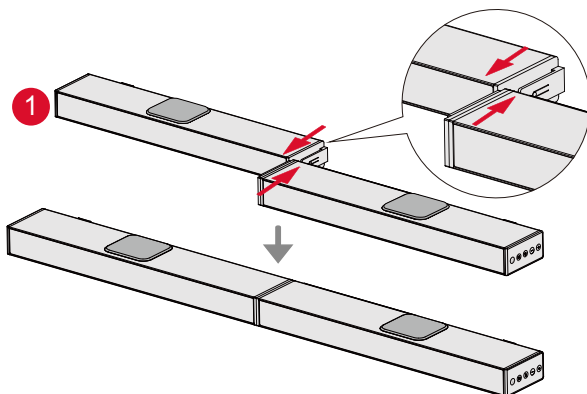

ステップ 2

ステレオ6ピンオーディオケーブルを差し込む。

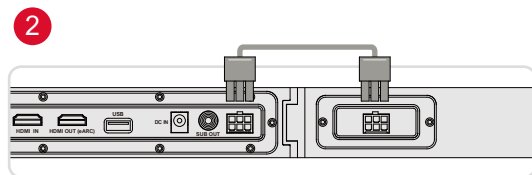

4 サブウーファーに接続する

JP

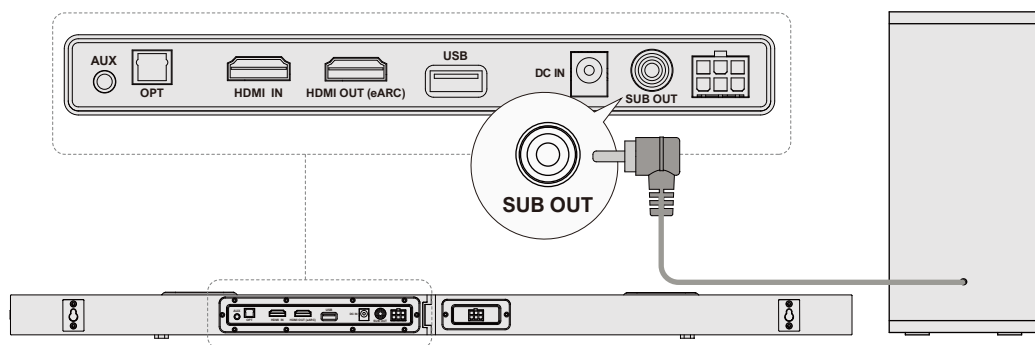

5 HDMI出力eARC / ARCを介してテレビに接続する

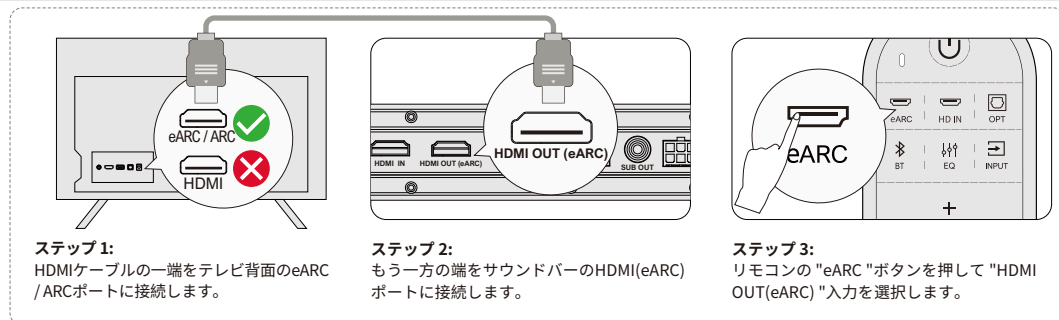

ステップ 1:

HDMIケーブルの一端をテレビ背面のeARC / ARCポートに接続します。

ステップ 2:

もう一方の端をサウンドバーのHDMI(eARC)ポートに接続します。

ステップ 3:

リモコンの "eARC" ボタンを押して "HDMI OUT(eARC)" 入力を選択します。

注意:

Dolby Atmos 音声フォーマットをサウンドバーに伝送するには、テレビのHDMIポートがeARCに対応している必要があります。

Atmos: Dolby Atmosフォーマットの映画を視聴する場合は、テレビの音声出力をパススルーに設定してください:

テレビの設定 > ホーム > 設定 > サウンド > デジタル音声出力 > パススルー

DTS: DTSフォーマットの映画を視聴する場合は、テレビの音声出力をPCMに設定してください:

テレビの設定 > ホーム > 設定 > サウンド > デジタル音声出力 > PCM

HDMI IN、HDMI ARC、HDMI eARCの違いは何ですか?

HDMI IN は、テレビやオーディオシステムに機器を接続するための標準的なHDMI入力です。オーディオとビデオ信号に対応していますが、オーディオ・リターン・チャンネル (ARC) やエンハンスト・オーディオ・リターン・チャンネル (eARC) 機能には対応していません。

HDMI ARC は、テレビとオーディオシステム間の双方向通信をサポートする特別なHDMIポートです。つまり、オーディオはテレビからオーディオ・システムに送られ、オーディオ・システムはテレビにオーディオを送り返すことができます。

HDMI eARC (Enhanced Audio Return Channel) は、Dolby AtmosやDTS:Xなどの高品質オーディオフォーマットをサポートするHDMI ARCのアップデートバージョンです。

注: テレビの「CEC」機能をオンにしてください。

eARC / ARCが接続されている場合、テレビのリモコンでサウンドバーとテレビを同時に操作できます:

- ① 電源オン/オフ
- ② 音量調整

6 HDMI入力で他の機器に接続する

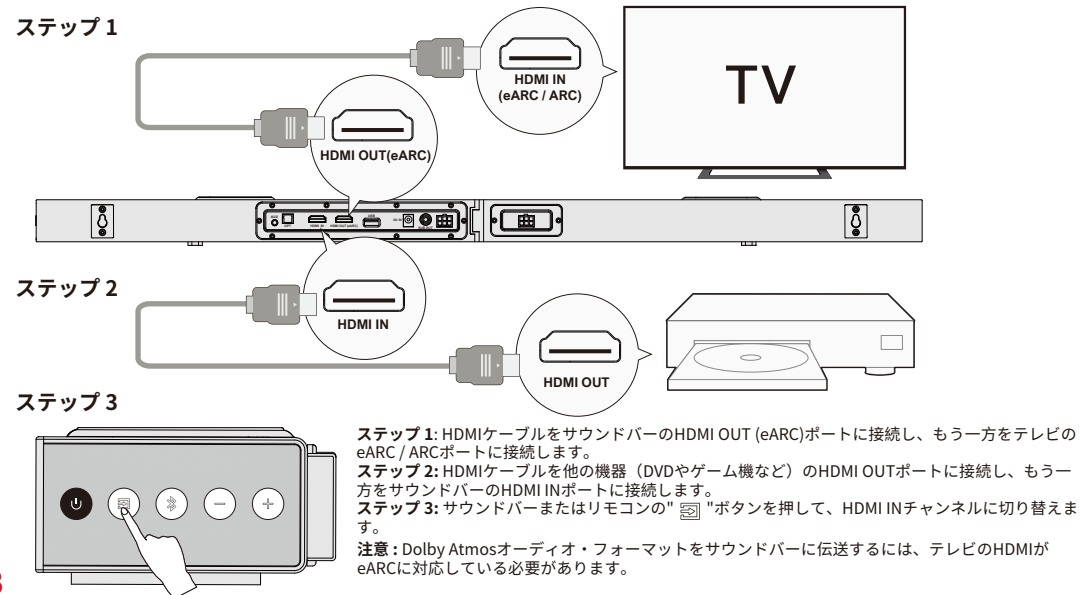

ステップ 1

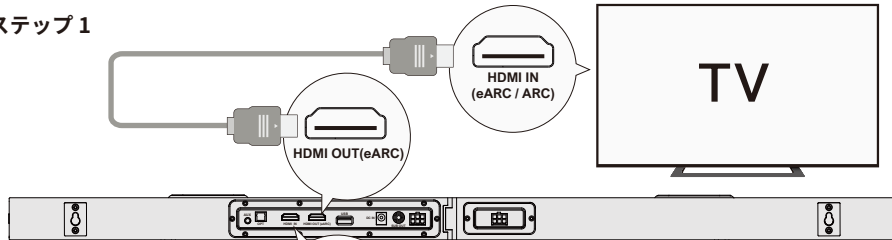

ステップ 2

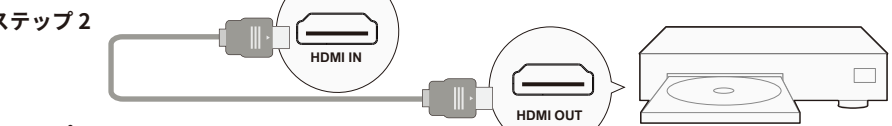

ステップ 3

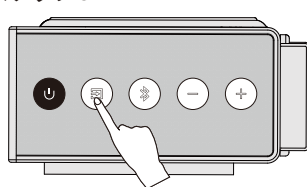

ステップ 1: HDMIケーブルをサウンドバーのHDMI OUT (eARC)ポートに接続し、もう一方をテレビのeARC / ARCポートに接続します。

ステップ 2: HDMIケーブルを他の機器 (DVDやゲーム機など) のHDMI OUTポートに接続し、もう一方をサウンドバーのHDMI INポートに接続します。

ステップ 3: サウンドバーまたはリモコンの " " ボタンを押して、HDMI INチャンネルに切り替えます。

注意: Dolby Atmosオーディオ・フォーマットをサウンドバーに伝送するには、テレビのHDMIがeARCに対応している必要があります。

7 オプティカル/AUXでテレビに接続

光学式

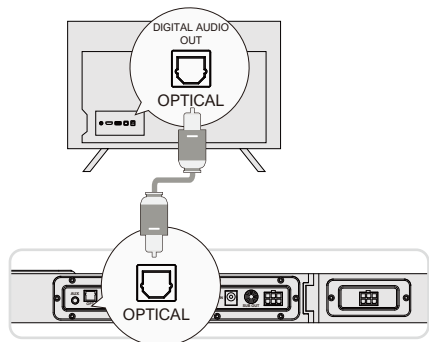

オプション1: 光学式

- 1 テレビのポートがOPTICAL OUTであることを確認し、ケーブルの両側をテレビとサウンドバーの両方でOPTICALに接続します。
 - 2 コードの差し込み口が写真のように正しく差し込まれていることを確認してください。
(間違って差し込むと破損する恐れがあり)
- 注: 接続した後、テレビのスピーカーからも音声が再生される場合は、テレビの音量をミュートまたは最小にしてください。

AUX

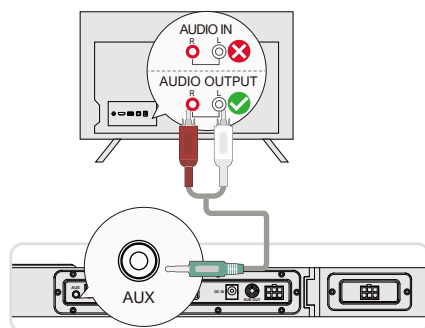

オプション2: AUX

- 1 3.5mmオーディオケーブルをテレビのRCA AUDIO OUTポートに接続します。
 - 2 ケーブルの端の色がテレビのポートの色と同じであることを確認してください。ポートに接続してください。
- 注: 他のモードに切り替える場合は、テレビとサウンドバーからAUXケーブルを抜いてください。

オプティカルモード: 音が出ない場合は、テレビの音声出力をPCMに設定してください。
TV設定>ホーム>設定>サウンド>デジタル音声出力>PCM

8 ブルートゥース接続

- 1 サウンドバーまたはリモコンの "Bluetooth" ボタンを押してBluetoothペアリングモードに入ります。
 - 2 携帯電話のBluetooth設定を開き、"Nova S70" を見つけて選択し、サウンドバーを接続します。
- 注: すでにBluetoothモードで接続されている場合は、"Bluetooth" ボタンを3秒間長押しして、現在のデバイスを切断し、携帯電話/PC/テレビで手動で新しいデバイスに接続します。

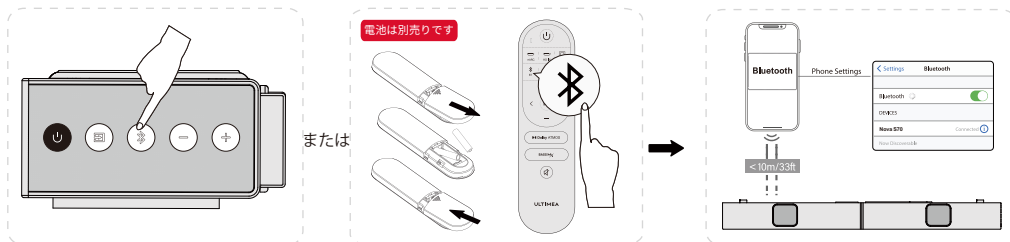

9 配置オプション

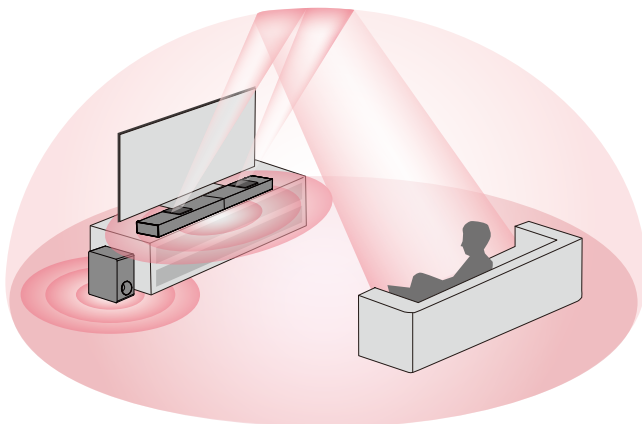

注意: サウンドバーは耳の高さか、その近くに設置してください。

10 壁掛け設置

JP

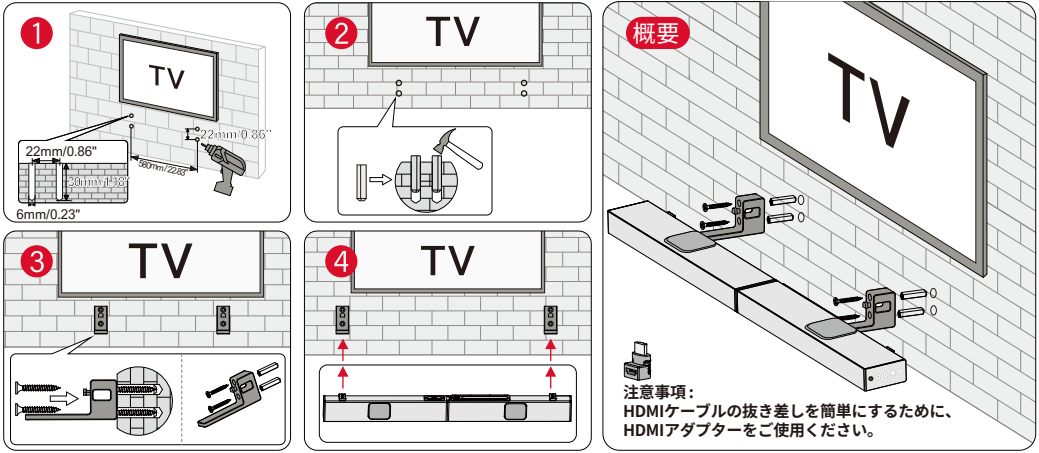

11 仕様

モデル番号	U3920
電源	AC 100-240V, ~50 / 60Hz
サウンドバードライバー	(3.1インチ×1.2インチ)×3(サウンドバー)+1.8インチ×2 (上向きドライバー)+5.25インチ×1(サブウーファー)
周波数応答	45Hz - 18kHz
スタンバイ電力	<0.5W
動作温度	0°C - 45°C / 32°F - 113°F
ブルートゥースバージョン	5.3

寸法と重量		
サウンドバー	800(W) x 38(H) x 90(D)mm	31.5" x 1.5" x 3.5"
サブウーファー	270(W) x 115(H) x 270(D)mm	10.6" x 4.5" x 10.6"
パッケージ	332(W) x 432(H) x 190(D)mm	13.1" x 17" x 7.5"
正味重量	4.15kg / 9.15lbs	
総重量	5.1kg / 11.24lbs	

ULTIMEA

Nova S70

Manuel de l'utilisateur



Numéro de modèle : U3920

NOUS SOMMES PRÊTS À VOUS AIDER



support@ultimea.com

FR

Vous préférez un tutoriel vidéo ?

Vidéo d'aide à l'installation, ou MANUEL D'UTILISATION sur le site web d'ULTIMEA.

@ultimea_official



support.ultimea.com

+1 888-598-8875 (US) Mon-Fri 9am-5pm (PST)
+49 89-628-25828 (EU) Mon-Fri 9am-5pm (CET)

1 LISTE DES ACCESSOIRES



Barre de son



Caisson de basse

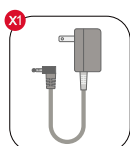

Adaptateur d'alimentation

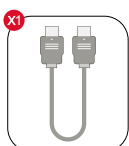

Câble HDMI

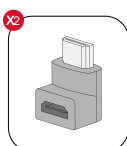

Adaptateur HDMI

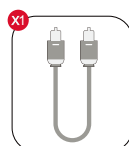

Câble optique numérique

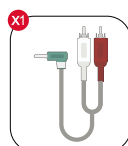

Câble audio stéréo 3.5 mm vers RCA

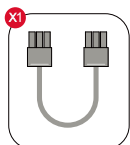

Câble à 6 broches pour la connexion de la barre de son (140 mm)



Télécommande

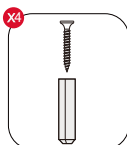

Kit de montage mural

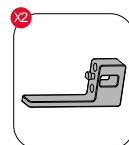

Support mural



Manuel de l'utilisateur

2 COMMANDES DE LA BARRE DE SON

Panneau de contrôle

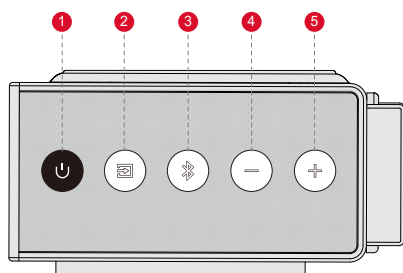

- 1 "⏻": Bouton d'alimentation**
Appuyez sur ce bouton pour allumer l'appareil / Maintenez-le enfoncé pendant 3 secondes pour l'éteindre.
- 2 "📺": Mode d'entrée**
Appuyez sur cette touche pour changer de canal : eARC-HD IN (HDMI IN) -OPT (OPTICAL)-BT-AUX-USB.
- 3 "📶": BT**
Appuyez sur cette touche pour passer au canal BT et entrer en mode d'appairage / Maintenez-la enfoncée pendant 3 secondes pour déconnecter l'appareil actuel et vous connecter manuellement à un nouvel appareil sur votre téléphone portable / PC / TV (BT ID: Nova S70).
- 4 "⏪": Réduction du volume**
- 5 "⏩": Augmentation du volume**

Télécommande

- 1 "U" : **Bouton d'alimentation**
Appuyer pour mettre sous tension / Maintenir pendant 3 secondes pour mettre hors tension.
- 2 "eARC" : **eARC**
Appuyez sur cette touche pour passer au canal HDMI eARC.
- 3 "HD IN" : **HD IN**
Appuyez sur cette touche pour passer au canal HDMI IN.
- 4 "OPT" : **OPT**
Appuyez sur cette touche pour passer au canal OPTICAL.
- 5 "BT" : **BT**
Appuyez sur cette touche pour passer au canal Bluetooth et entrer en mode d'appairage. Maintenez cette touche enfoncée pendant 3 secondes pour déconnecter l'appareil actuel et vous connecter manuellement à un nouvel appareil sur votre téléphone portable / PC / TV (BT ID: Nova S70).
- 6 "EQ" : **EQ**
Appuyez sur cette touche pour basculer entre les modes Film, Dialogue et Musique: "MOVIE", "DIALOG", "MUSIC".
- 7 "INPUT" : **INPUT**
Appuyez sur cette touche pour changer de canal : eARC-HD IN (HDMI IN) -OPT (OPTICAL)-BT-AUX-USB.
- 8 "+" : **Augmentation du volume**
- 9 "-" : **Baisse du volume**
- 10 "<" : **Précédent**
Pour les modes BT et USB uniquement: Passer à la piste précédente.
- 11 ">" : **Suivant**
Pour les modes BT et USB uniquement: Passer à la piste suivante.
- 12 "▶||" : **Lecture / Pause**
Pour les modes BT et USB uniquement.
Mode USB : Maintenez cette touche enfoncée pendant 3 secondes pour basculer entre la lecture d'une boucle unique et la lecture d'une boucle de liste.
- 13 "Dolby ATMOS" : **Dolby Atmos**
Appuyez sur cette touche pour régler le niveau sonore vers le haut, l'écran affiche: "RT 1", "RT 0", "RT - 1".
- 14 "BASS MAX" : **BASSMAX**
Appuyez sur cette touche pour régler le niveau des basses: "B5- 2", "B5- 1", "B5 0", "B5 1", "B5 2".
- 15 "Mute" : **Mute / Récupérer le volume.**

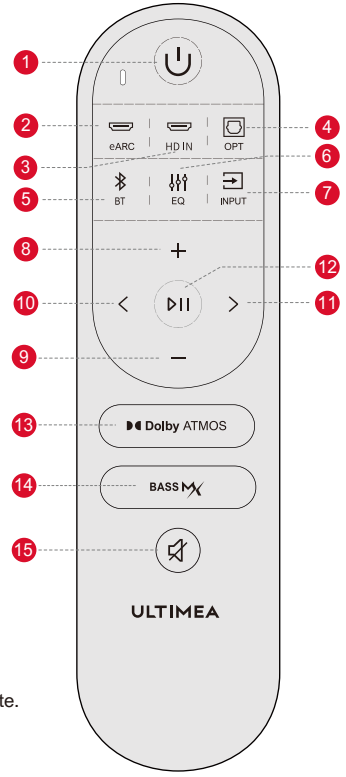

3 INSTALLATION DE LA BARRE DE SON

Étapes de l'assemblage

Étape 1

Placer les deux parties de la barre de son au même niveau et aligner les joints de connexion. Relier les deux parties en les poussant parallèlement pour qu'elles ne forment plus qu'une seule pièce.

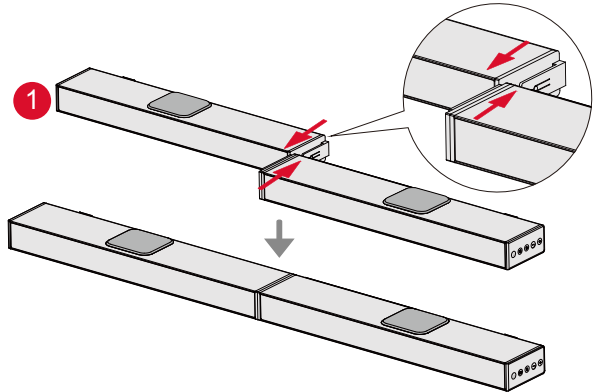

Étape 2

Brancher les câbles audio stérééo à 6 broches.

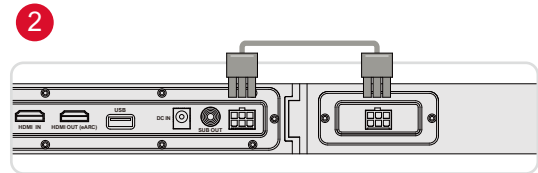

4 CONNECTER AU CAISSON DE BASSE

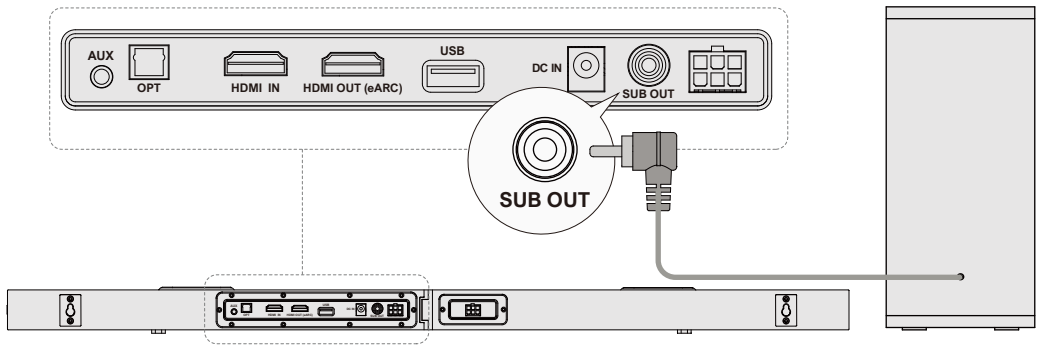

FR

5 CONNECTER AU TELEVISEUR VIA HDMI OUT eARC / ARC

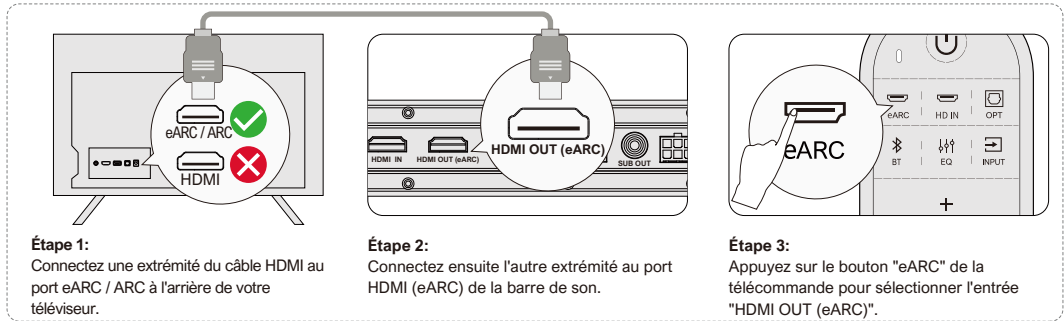

Étape 1:
Connectez une extrémité du câble HDMI au port eARC / ARC à l'arrière de votre téléviseur.

Étape 2:
Connectez ensuite l'autre extrémité du câble HDMI (eARC) de la barre de son.

Étape 3:
Appuyez sur le bouton "eARC" de la télécommande pour sélectionner l'entrée "HDMI OUT (eARC)".

Remarque:

Le port HDMI de votre téléviseur doit prendre en charge l'eARC pour transmettre le format audio Dolby Atmos à votre soundbar.

Atmos: Si vous regardez un film au format Dolby Atmos, réglez la sortie audio de votre téléviseur sur Pass Through :

Réglages TV > Accueil > Réglages > Son > Sortie audio numérique > Pass Through

DTS: Si vous regardez un film au format DTS, réglez la sortie audio de votre téléviseur sur PCM :

Réglages TV > Accueil > Réglages > Son > Sortie audio numérique > PCM

Quelle est la différence entre : HDMI IN, HDMI ARC, HDMI eARC ?

HDMI IN est une entrée HDMI standard qui vous permet de connecter des appareils à votre téléviseur ou à votre système audio. Elle prend en charge les signaux audio et vidéo, mais ne prend pas en charge la fonctionnalité de canal de retour audio (ARC) ou de canal de retour audio amélioré (eARC).

HDMI ARC est un port HDMI spécial qui prend en charge la communication bidirectionnelle entre votre téléviseur et votre système audio. Cela signifie que le son peut être envoyé de votre téléviseur à votre système audio, et que le système audio peut renvoyer le son à votre téléviseur.

HDMI eARC (Enhanced Audio Return Channel) est une version actualisée de HDMI ARC qui prend en charge des formats audio de meilleure qualité tels que Dolby Atmos et DTS:X.

Remarque : veuillez activer la fonction "CEC" sur votre téléviseur.

Lorsque eARC / ARC est connecté, la télécommande de votre téléviseur peut contrôler la barre de son et le téléviseur simultanément: 1 Allumer / éteindre 2 Régler le volume

6 CONNECTER À UN AUTRE APPAREIL VIA L'ENTRÉE HDMI

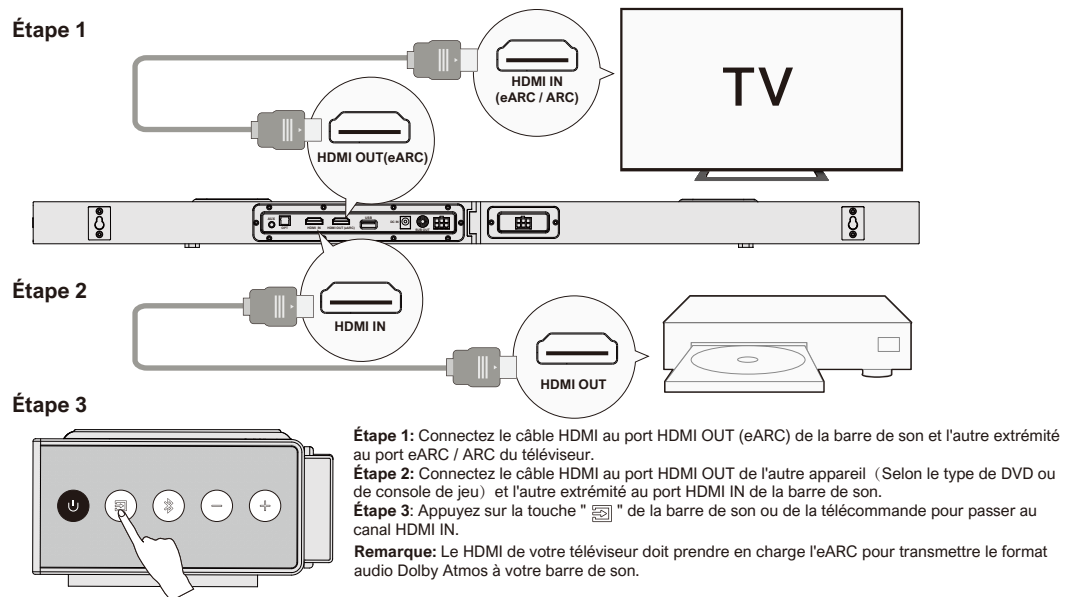

Étape 1

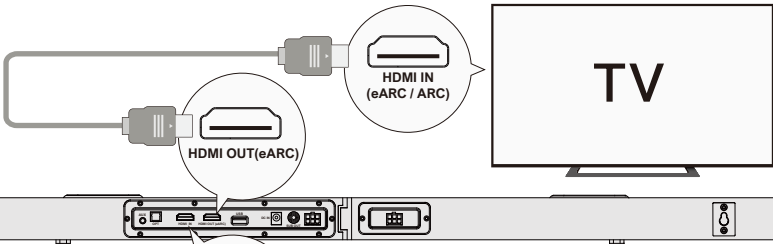

Étape 2

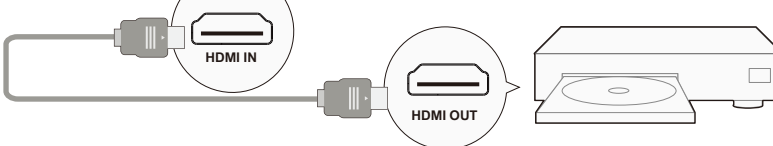

Étape 3

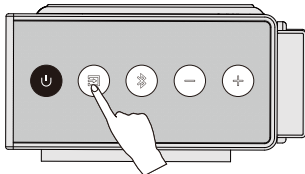

Étape 1: Connectez le câble HDMI au port HDMI OUT (eARC) de la barre de son et l'autre extrémité au port eARC / ARC du téléviseur.

Étape 2: Connectez le câble HDMI au port HDMI OUT de l'autre appareil (Selon le type de DVD ou de console de jeu) et l'autre extrémité au port HDMI IN de la barre de son.

Étape 3: Appuyez sur la touche "HDMI" de la barre de son ou de la télécommande pour passer au canal HDMI IN.

Remarque: Le HDMI de votre téléviseur doit prendre en charge l'eARC pour transmettre le format audio Dolby Atmos à votre barre de son.

7 CONNECTER AU TÉLÉVISEUR VIA OPTIQUE / AUX

OPTIQUE

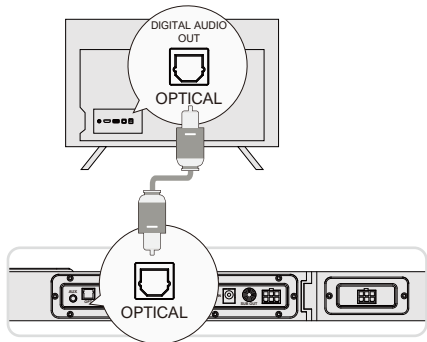

OPTION 1 : OPTIQUE

- 1 Assurez-vous que le câble est connecté au port OPTICAL OUT de votre téléviseur et l'autre extrémité au port OPTICAL de la barre de son.
 - 2 Assurez-vous que la prise optique est insérée correctement, comme indiqué sur l'image. N'insérez pas la fiche à l'envers et ne cassez pas le câble optique.
- Remarque:** Si le son est diffusé par les haut-parleurs internes du téléviseur, coupez ou réduisez le volume du téléviseur.

AUX

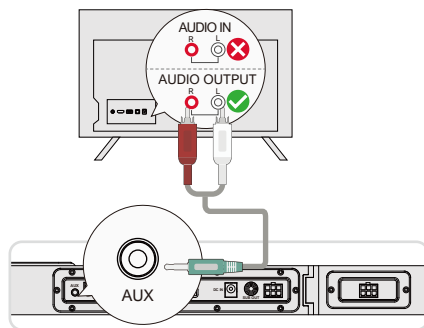

OPTION 2 : AUX

- 1 Connectez le câble audio 3.5 mm vers RCA au port OPTICAL OUT de votre téléviseur.
 - 2 Assurez-vous que la couleur des extrémités du câble correspond à la couleur des ports du téléviseur.
- Remarque:** N'oubliez pas de débrancher le câble AUX de la télévision et de la barre de son lorsque vous souhaitez changer de mode.

En mode optique : S'il n'y a pas de son, essayez de régler la sortie audio du téléviseur sur PCM :
Réglages TV > Accueil > Réglages > Son > Sortie audio numérique > PCM

8 CONNECTER À BLUETOOTH®

- 1 Appuyez sur le bouton "Bluetooth" de la barre de son ou de la télécommande pour entrer en mode d'appairage Bluetooth.
- 2 Ouvrez les paramètres Bluetooth de votre téléphone, recherchez et sélectionnez "Nova S70" pour connecter la barre de son.

Remarque: Si l'appareil est déjà en mode Bluetooth et connecté, appuyez sur le bouton "Bluetooth" et maintenez-le enfoncé pendant 3 secondes pour déconnecter l'appareil actuel et vous connecter manuellement à un nouvel appareil sur votre téléphone portable / PC / TV.

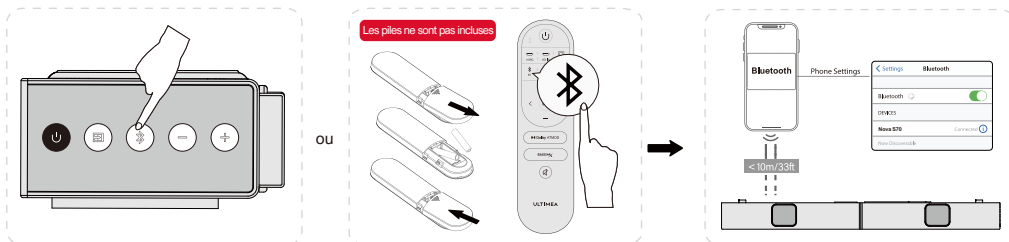

9 OPTIONS DE PLACEMENT

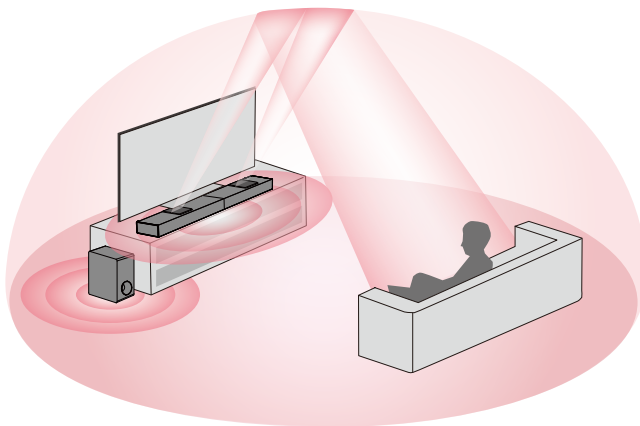

Remarque: La barre de son doit être placée à hauteur d'oreille ou presque.

10 INSTALLATION MURALE

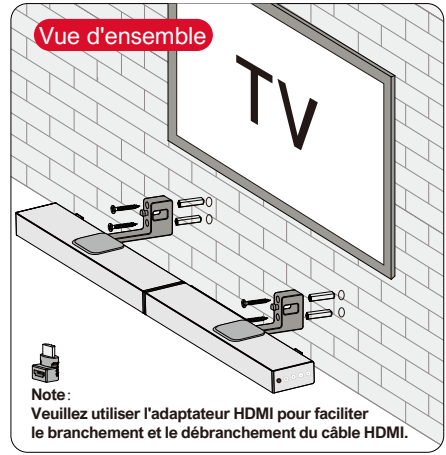
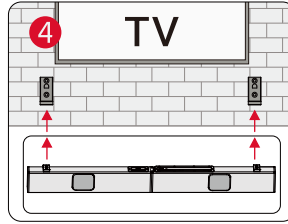
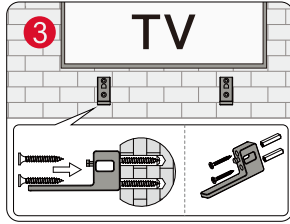
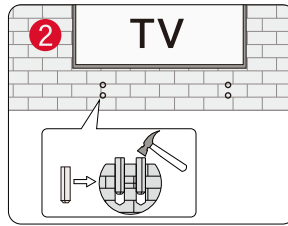
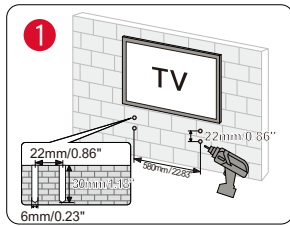

FR

11 CARACTÉRISTIQUES TECHNIQUES

Numéro de modèle	U3920
Alimentation électrique	AC 100-240V, ~50 / 60Hz
Pilotes de la barre de son	(3.1" x 1.2") x 3(barre de son)+ 1.8" x 2(pilote ascendant) + 5.25" x 1(subwoofer)
Réponse en fréquence	45Hz - 18kHz
Puissance en veille	<0.5W
Température de fonctionnement	0°C - 45°C / 32°F - 113°F
Vision Bluetooth	5.3

Dimensions et poids		
Barre de son	800(W) x 38(H) x 90(D)mm	31.5" x 1.5" x 3.5"
Caisson de basse	270(W) x 115(H) x 270(D)mm	10.6" x 4.5" x 10.6"
Emballage	332(W) x 432(H) x 190(D)mm	13.1" x 17" x 7.5"
Poids net	4.15kg / 9.15lbs	
Poids brut	5.1kg / 11.24lbs	

ULTIMEA

Nova S70

Manuale Utente

SIAMO PRONTI AD AIUTARTI



support@ultimea.com

IT



Modello N.: U3920

Preferisci un tutorial video?

Video guida all'installazione o MANUALE UTENTE sul sito web di ULTIMEA.

[Twitter](#) [Facebook](#) [Instagram](#) [YouTube](#) [TikTok](#)
@ultimea_official



support.ultimea.com

+1 888-598-8875 (US) Mon-Fri 9am-5pm (PST)
+49 89-628-25828 (EU) Mon-Fri 9am-5pm (CET)

1 ELENCO DEGLI ACCESSORI

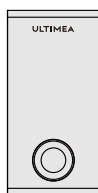

Subwoofer



Soundbar

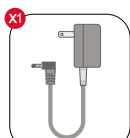

Adattatore di alimentazione

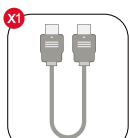

Cavo HDMI

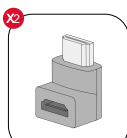

Adattatore HDMI

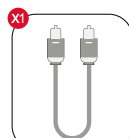

Cavo ottico digitale

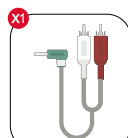

Cavo audio stereo da 3.5 mm a RCA

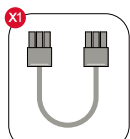

Cavo da 6 pin per connessione alla soundbar (140 mm)



Telecomando

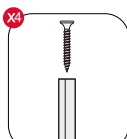

Kit di montaggio a parete

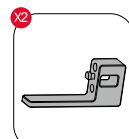

Staffa a parete



Manuale Utente

2 CONTROLLI DELLA SOUNDBAR

Pannello di controllo

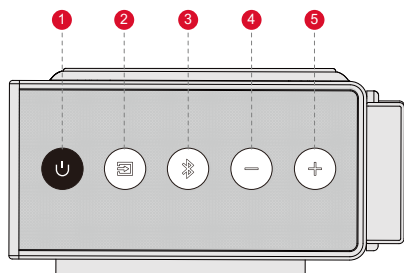

- 1 "⏻": Pulsante di accensione**
Premere per accendere / Tenere premuto per 3 secondi per spegnere.
- 2 "📺": Modalità di ingresso**
Premere per cambiare canale: eARC-HD IN (HDMI IN) -OPT (OPTICAL)-BT-AUX-USB.
- 3 "📶": BT**
Premere per passare al canale BT / Tenere premuto per 3 secondi per scollegare il dispositivo corrente e collegarsi a un nuovo dispositivo. (BT ID: Nova S70).
- 4 "⏪": Volume giù**
- 5 "⏩": Volume su**

Telecomando

- 1 "U": **Pulsante di accensione**
Premere per accendere / Tenere premuto per 3 secondi per spegnere.
- 2 "eARC": **eARC**
Premere per passare al canale HDMI eARC.
- 3 "HD IN": **HD IN**
Premere per passare al canale HDMI IN.
- 4 "OPT": **OPT**
Premere per passare al canale OTTICO.
- 5 "BT": **BT**
Premere per passare al canale BT / Tenere premuto per 3 secondi per disconnettere il dispositivo attuale e connettersi a un nuovo dispositivo (BT ID: Nova S70).
- 6 "EQ": **EQ**
Premere per passare tra le modalità Film, Dialogo, Musica, il display mostrerà: "MOVIE", "DIALOG", "MUSIC".
- 7 "INPUT": **INPUT**
Premere per passare ai canali: eARC-HD IN (HDMI IN) -OPT (OTTICO)-BT-AUX-USB.
- 8 "+": **Volume su**
- 9 "-": **Volume giù**
- 10 "<": **Precedente**
Modalità BT e USB: Passa alla traccia precedente.
- 11 ">": **Successivo**
Modalità BT e USB: Passa alla traccia successiva.
- 12 "▶||": **Riproduci / Pausa**
Solo per modalità BT e USB.
Modalità USB: Tenere premuto per 3 secondi per passare tra la riproduzione in loop singolo e la riproduzione in loop della lista.
- 13 "Dolby Atmos": **Dolby Atmos**
Premere per regolare il livello del suono ad altoparlanti orientati verso l'alto, il display mostrerà: "AT 1", "AT 0", "AT -1".
- 14 "BASS MAX": **BASSMAX**
Premere per regolare il livello dei bassi, il display mostrerà: "B5-2", "B5-1", "B5 0", "B5 1", "B5 2".
- 15 "Mute": **Muto / Ripristino del volume.**

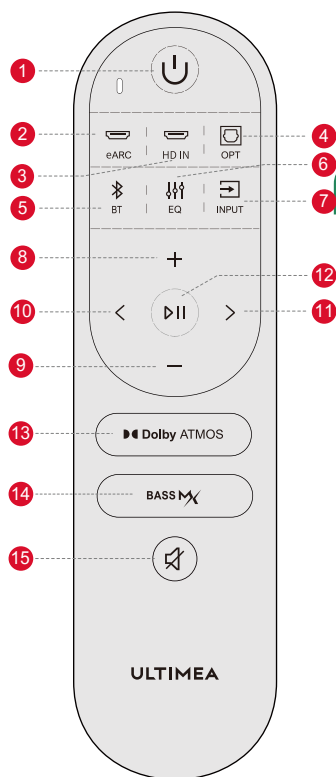

IT

3 INSTALLAZIONE DELLA SOUNDBAR

Passaggi di assemblaggio

Passaggio 1

Posiziona le due parti della soundbar allo stesso livello e allinea le giunture di connessione. Collega le due parti spingendo parallelamente per unirle come un unico pezzo.

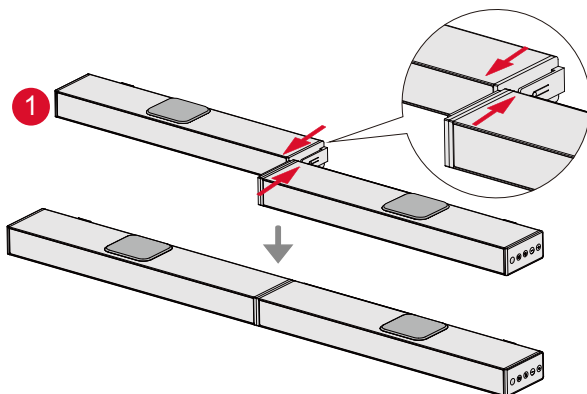

Passaggio 2

Collega i cavi audio stereo da 6 pin.

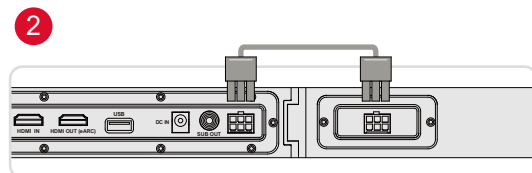

4 COLLEGAMENTO AL SUBWOOFER

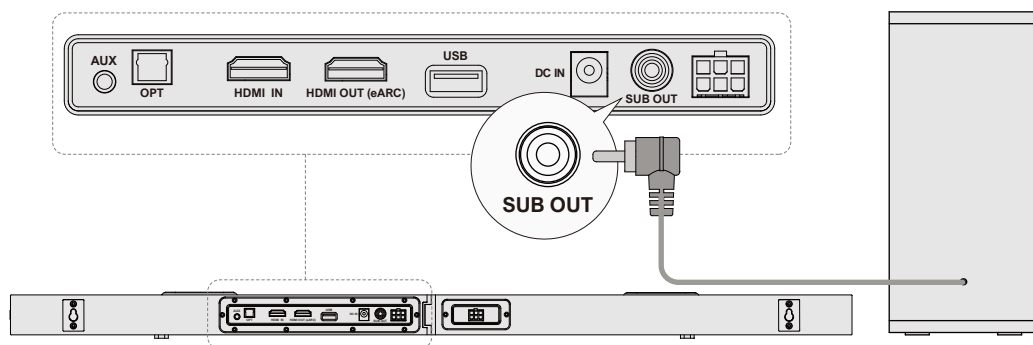

IT

5 COLLEGAMENTO ALLA TV TRAMITE HDMI OUT eARC / ARC

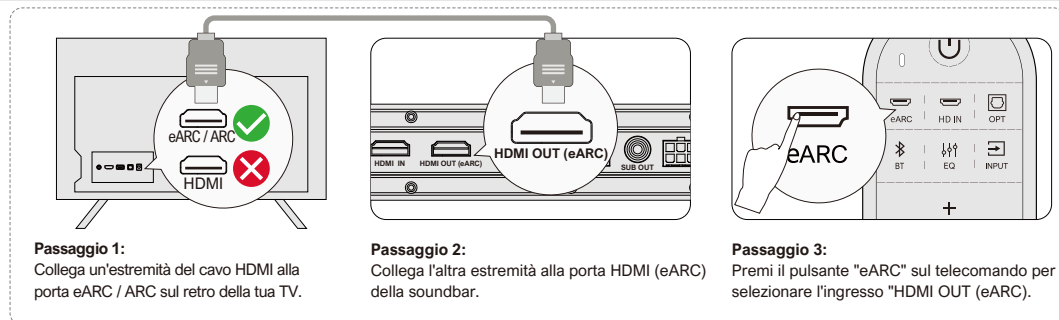

Passaggio 1:

Collega un'estremità del cavo HDMI alla porta eARC / ARC sul retro della tua TV.

Passaggio 2:

Collega l'altra estremità alla porta HDMI (eARC) della soundbar.

Passaggio 3:

Premi il pulsante "eARC" sul telecomando per selezionare l'ingresso "HDMI OUT (eARC)".

Nota:

La porta HDMI della tua TV deve supportare eARC per trasmettere l'audio Dolby Atmos alla tua soundbar.

Atmos: Se stai guardando un film nel formato Dolby Atmos, imposta l'uscita audio sulla tua TV su Pass Through:

Impostazioni TV > Home > Impostazioni > Audio > Uscita audio digitale > Pass Through

DTS: Se stai guardando un film nel formato DTS, imposta l'uscita audio sulla tua TV su PCM:

Impostazioni TV > Home > Impostazioni > Audio > Uscita audio digitale > PCM

Qual è la differenza tra: HDMI IN, HDMI ARC, HDMI eARC?

HDMI IN è un ingresso HDMI standard che consente di collegare i dispositivi al televisore o al sistema audio. Supporta segnali audio e video, ma non supporta la funzionalità ARC (Audio Return Channel) o eARC (Enhanced Audio Return Channel).

HDMI ARC è una porta HDMI speciale che supporta la comunicazione bidirezionale tra il televisore e il sistema audio. Ciò significa che l'audio può essere inviato dal televisore al sistema audio e il sistema audio può inviare l'audio al televisore.

HDMI eARC (Enhanced Audio Return Channel) è una versione aggiornata dell'HDMI ARC che supporta formati audio di qualità superiore come Dolby Atmos e DTS:X.

Nota: attivare la funzione "CEC" sul televisore.

Quando è collegato eARC / ARC, il telecomando del televisore può controllare contemporaneamente la soundbar e il televisore:

- 1 Accendere / Spegnerne
- 2 Regolare il volume

6 COLLEGAMENTO AD ALTRI DISPOSITIVI TRAMITE INGRESSO HDMI

Fase 1

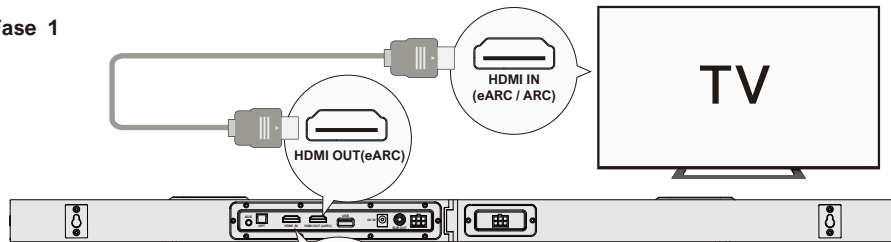

Fase 2

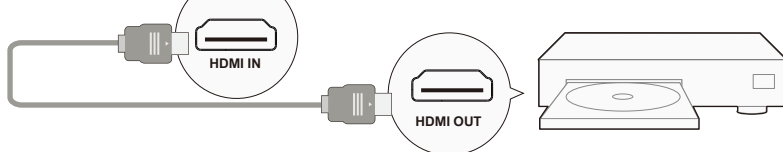

Fase 3

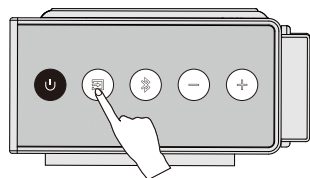

Étape 1: Collegare il cavo HDMI alla porta HDMI OUT (eARC) della Soundbar e l'altra estremità alla porta eARC / ARC del televisore.

Étape 2: Collegare il cavo HDMI alla porta HDMI OUT dell'altro dispositivo (ad esempio un DVD o una console per videogiochi) e l'altra estremità alla porta HDMI IN della Soundbar.

Étape 3: Premere il pulsante "HDMI IN" sulla Soundbar o sul telecomando per passare al canale HDMI IN.

Nota: L'HDMI del televisore deve supportare eARC per trasmettere il formato audio Dolby Atmos alla Soundbar.

7 COLLEGAMENTO ALLA TV VIA OTTICO / AUX

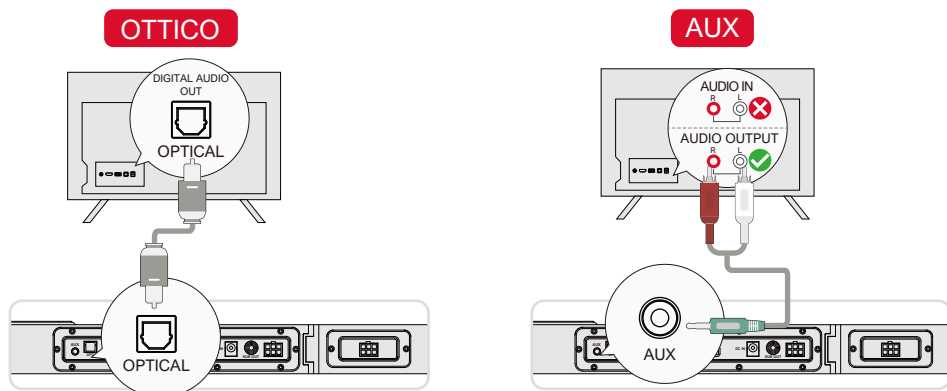

OPZIONE 1: OTTICO

1 Assicurarsi che il cavo sia collegato alla porta OPTICAL OUT del televisore e l'altra estremità alla porta OPTICAL del sistema Soundbar.

2 Assicurarsi che la spina ottica sia inserita correttamente come mostrato nell'immagine. Non inserire la spina al contrario e non rompere l'ottica.

Nota: Se l'audio viene riprodotto dagli altoparlanti interni del televisore, disattivare o ridurre al minimo il volume del televisore.

OPZIONE 2: AUX

1 Collegare il cavo audio da 3.5 mm a RCA alla porta RCA AUDIO OUT del televisore.

2 Assicurarsi che il colore delle estremità dei cavi corrisponda a quello delle porte del televisore.

Nota: Ricordarsi di scollegare il cavo AUX dal televisore e dalla Soundbar quando si desidera cambiare modalità

In modalità ottica: Se non si sente alcun suono, provare a impostare l'uscita audio del televisore su PCM:
Impostazioni TV > Home > Impostazioni > Audio > Uscita audio digitale > PCM.

8 COLLEGARSI AL BLUETOOTH®

1 Premere il pulsante "Bluetooth" sulla soundbar o sul telecomando per accedere alla modalità di accoppiamento Bluetooth.

2 Aprire le impostazioni Bluetooth del telefono, trovare e selezionare "Nova S70" per collegare la soundbar.

Nota: Se è già in modalità Bluetooth e collegato, tenere premuto il pulsante "Bluetooth" per 3 secondi per scollegare il dispositivo corrente e collegarsi manualmente a un nuovo dispositivo sul telefono cellulare / PC / TV.

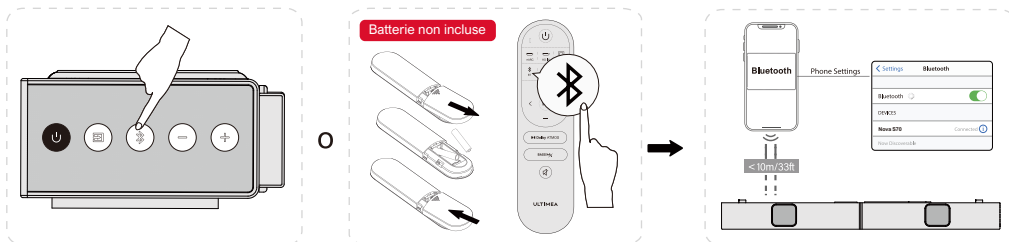

9 OPZIONI DI COLLOCAMENTO

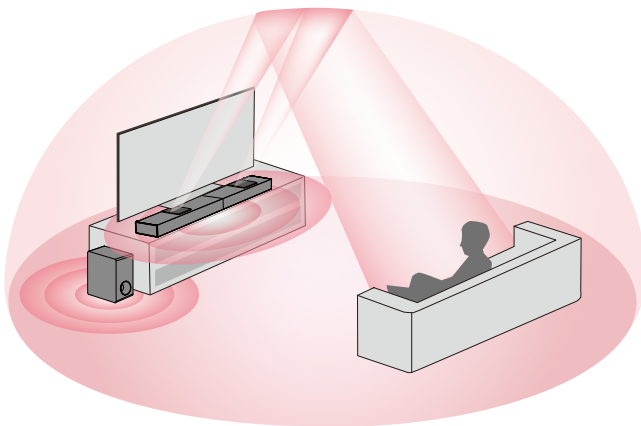

Nota: La soundbar deve essere posizionata all'altezza delle orecchie o vicino ad esse.

10 INSTALLAZIONE A MURO

IT

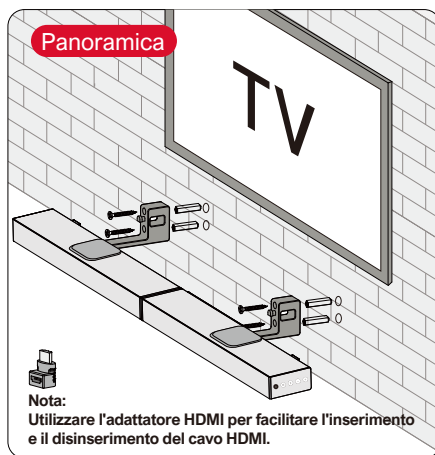
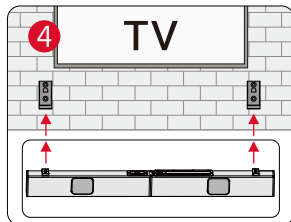
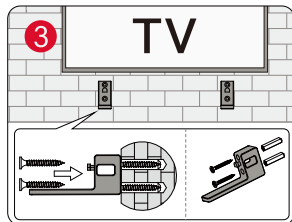
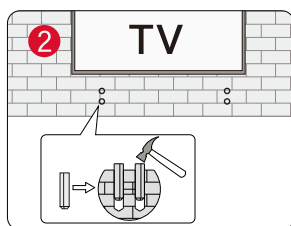
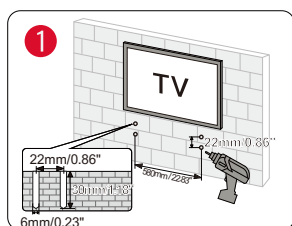

11 SPECIFICHE

Numero di modello	U3920
Alimentazione	AC 100-240V, ~50 / 60Hz
Driver della Soundbar	(3.1" x 1.2") x 3 (Soundbar) + 1.8" x 2 (driver che sparano verso l'alto) + 5.25" x 1 (subwoofer)
Risposta in frequenza	45Hz - 18kHz
Potenza in standby	<0.5W
Temperatura di esercizio	0°C - 45°C / 32°F - 113°F
Visione Bluetooth	5.3

Dimensioni e peso		
Soundbar	800(W) x 38(H) x 90(D)mm	31.5" x 1.5" x 3.5"
Subwoofer	270(W) x 115(H) x 270(D)mm	10.6" x 4.5" x 10.6"
Imballaggio	332(W) x 432(H) x 190(D)mm	13.1" x 17" x 7.5"
Peso netto	4.15kg / 9.15lbs	
Peso lordo	5.1kg / 11.24lbs	

ULTIMEA

Nova S70

Manual de usuario

ESTAMOS LISTOS PARA AYUDAR



support@ultimea.com



Nº de modelo: U3920

¿Prefiere un tutorial en vídeo?

Vídeo guía de instalación o MANUAL DE USUARIO en el sitio web de ULTIMEA.

@ultimea_oficial



support.ultimea.com

ES

+1 888-598-8875 (US) Mon-Fri 9am-5pm (PST)
+49 89-628-25828 (EU) Mon-Fri 9am-5pm (CET)

1 LISTADO DE ACCESORIOS

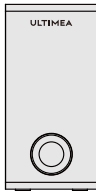

Subwoofer



Barra de sonido



Adaptador de corriente

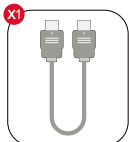

Cable HDMI

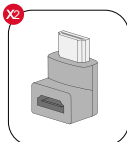

Adaptador HDMI

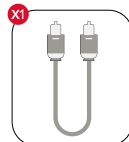

Cable digital óptico

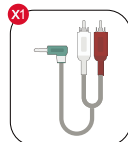

Cable de audio estéreo de 3.5 mm a RCA

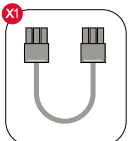

Cable de 6 clavijas para conexión de barra de sonido (140 mm)



Mando a distancia

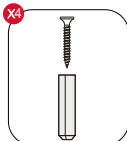

Kit de montaje en pared

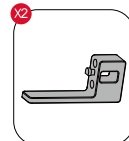

Soporte de pared



Manual del usuario

2 CONTROLES DE LA BARRA DE SONIDO

Panel de control

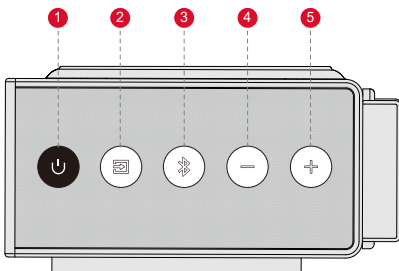

- 1 “⏻”: **Botón de encendido**
Pulse para encender / Mantenga pulsado durante 3 segundos para apagar.
- 2 “📺”: **Modo de entrada**
Pulse para cambiar de canal: eARC-HD IN (HDMI IN) -OPT (OPTICAL)-BT-AUX-USB.
- 3 “📶”: **BT**
Pulse para cambiar al canal BT / Mantenga pulsado durante 3 segundos para desconectar el dispositivo actual y conectarse a un nuevo dispositivo. (BT ID: Nova S70).
- 4 “-”: **Bajar volumen**
- 5 “+”: **Subir volumen**

Mando a distancia

- 1 "U": **Botón de encendido**
Pulse para encender / Mantenga pulsado durante 3 segundos para apagar.
- 2 "eARC": **eARC**
Pulse para cambiar al canal HDMI eARC.
- 3 "HD IN": **HD IN**
Pulse para cambiar al canal HDMI IN.
- 4 "OPT": **OPT**
Pulse para cambiar al canal OPTICAL.
- 5 "BT": **BT**
Pulse para cambiar al canal BT / Mantenga pulsado durante 3 segundos para desconectar el dispositivo actual y conectarse a un nuevo dispositivo. (BT ID: Nova S70).
- 6 "EQ": **EQ**
Pulse para cambiar entre los modos Película, Diálogo, Música, la pantalla mostrará: "MOV", "LOG", "MUS".
- 7 "INPUT": **INPUT**
Pulse para cambiar de canal:
eARC-HD IN (HDMI IN) -OPT (OPTICAL)-BT-AUX-USB.
- 8 "+": **Subir Volumen**
- 9 "-": **Bajar volumen**
- 10 "<": **Anterior**
Modo BT y USB: Salta a la pista anterior.
- 11 ">": **Siguiente**
Modo BT y USB: Salta a la pista siguiente.
- 12 "▶||": **Reproducir / Pausa**
Sólo para los modos BT y USB.
Modo USB: Mantenga pulsado durante 3 segundos para cambiar entre reproducción de bucle simple y reproducción de bucle de lista.
- 13 "Dolby ATMOS": **Dolby Atmos**
Pulse para ajustar el nivel de sonido ascendente, la pantalla mostrará: "AT 1", "AT 0", "AT - 1".
- 14 "BASS MAX": **BASSMAX**
Pulse para ajustar el nivel de graves, la pantalla mostrará: "B5-2", "B5-1", "B5 0", "B5 1", "B5 2".
- 15 "Mute": **Silenciar / Recuperar el volumen.**

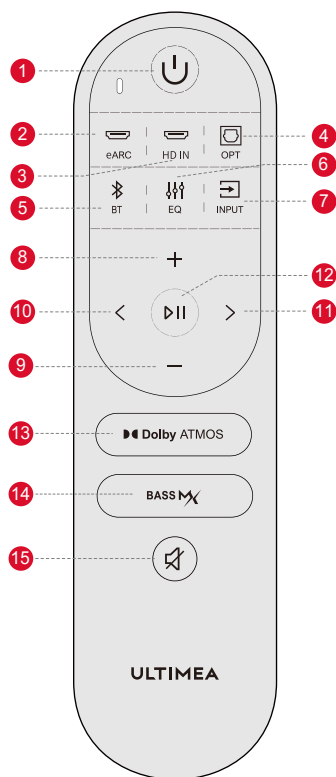

3 INSTALACIÓN DE LA BARRA DE SONIDO

Pasos de montaje

Paso 1

Coloque las dos partes de la barra de sonido al mismo nivel y alinee las juntas de conexión. 2. Conecte las dos partes empujando paralelamente para combinarlas como una sola pieza.

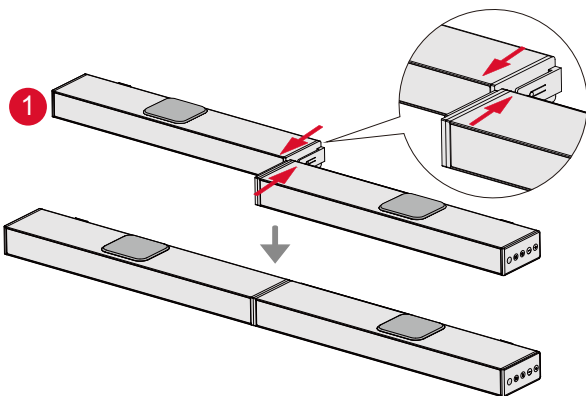

Paso 2

Enchufa los cables de audio estéreo de 6 clavijas.

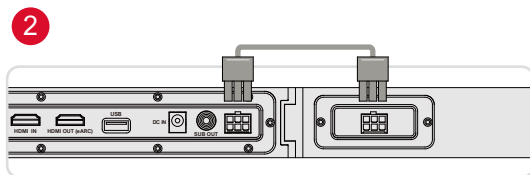

4 CONECTAR AL SUBWOOFER

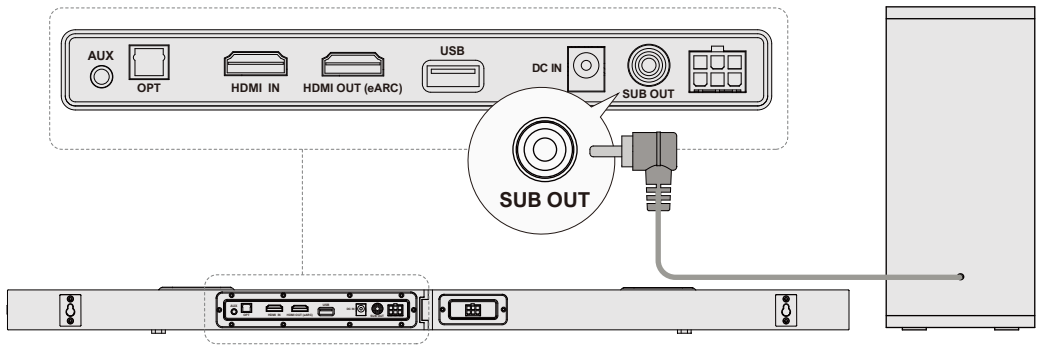

ES

5 CONECTE AL TELEVISOR A TRAVÉS DE LA SALIDA HDMI eARC / ARC

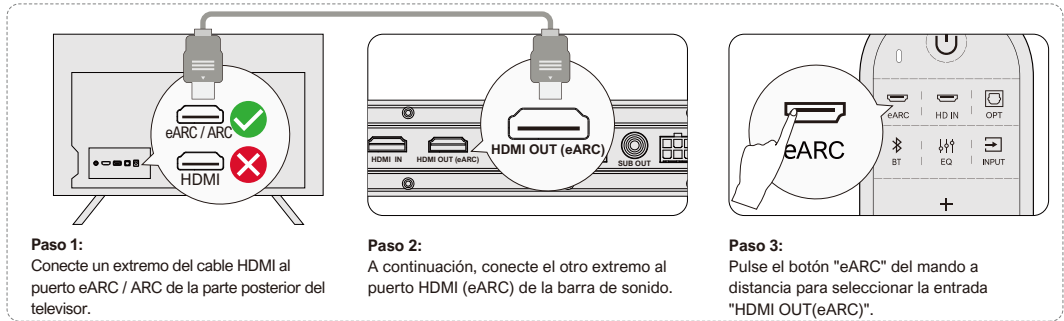

Paso 1:
Conecte un extremo del cable HDMI al puerto eARC / ARC de la parte posterior del televisor.

Paso 2:
A continuación, conecte el otro extremo al puerto HDMI (eARC) de la barra de sonido.

Paso 3:
Pulse el botón "eARC" del mando a distancia para seleccionar la entrada "HDMI OUT (eARC)".

Nota:

El puerto HDMI de su televisor debe ser compatible con eARC para transmitir el formato de audio Dolby Atmos a su Soundbar.

Atmos: Si está viendo una película en formato Dolby Atmos, ajuste la salida de audio del televisor en Pass Through:

Ajustes TV > Inicio > Ajustes > Sonido > Salida de audio digital > Pass Through.

DTS: Si está viendo una película en formato DTS, configure la salida de audio del televisor como PCM:

Ajustes TV > Inicio > Ajustes > Sonido > Salida de audio digital > PCM

¿Cuál es la diferencia entre: HDMI IN, HDMI ARC, HDMI eARC?

HDMI IN es una entrada HDMI estándar que permite conectar dispositivos al televisor o al sistema de audio. Admite señales de audio y video, pero no es compatible con las funciones de canal de retorno de audio (ARC) o canal de retorno de audio mejorado (eARC).

HDMI ARC es un puerto HDMI especial que permite la comunicación bidireccional entre el televisor y el sistema de audio. Esto significa que el audio puede enviarse desde el televisor al sistema de audio, y el sistema de audio puede devolver el audio al televisor.

HDMI eARC (canal de retorno de audio mejorado) es una versión actualizada de HDMI ARC que admite formatos de audio de mayor calidad, como Dolby Atmos y DTS:X.

Nota: Active la función "CEC" en su televisor.

Cuando eARC / ARC está conectado, el mando a distancia del televisor puede controlar la barra de sonido y el televisor simultáneamente: ❶ Encender / apagar ❷ Ajustar el volumen

6 CONECTE A OTRO DISPOSITIVO A TRAVÉS DE HDMI IN

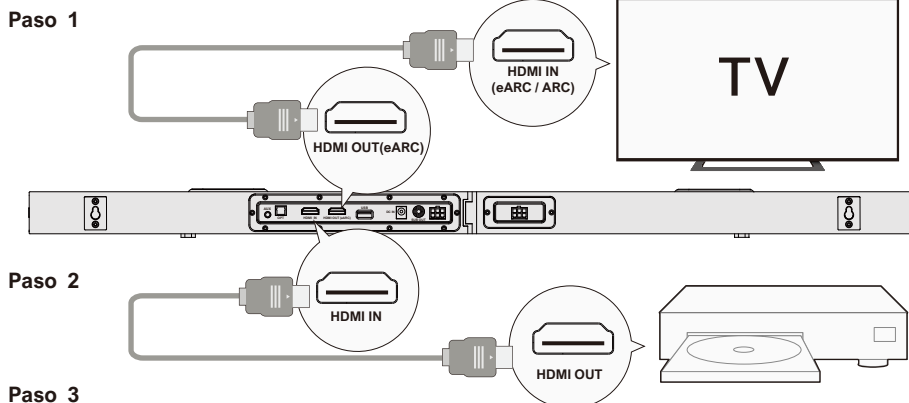

Paso 1

Paso 2

Paso 3

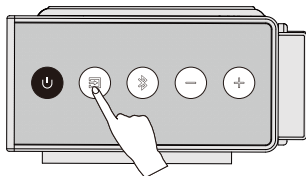

Paso 1: Conecte el cable HDMI al puerto HDMI OUT (eARC) de la barra de sonido y el otro extremo al puerto eARC / ARC del televisor.

Paso 2: Conecte el cable HDMI al puerto HDMI OUT del otro dispositivo (Tal como DVD o videoconsola) y el otro extremo al puerto HDMI IN de la Soundbar.

Paso 3: Pulse el botón " " en el Soundbar o en el mando a distancia para cambiar a canal HDMI IN.

Nota: El HDMI del televisor debe ser compatible con eARC para transmitir el formato de audio Dolby Atmos a la barra de sonido.

7 CONEXIÓN AL TELEVISOR VÍA ÓPTICA / AUX

ÓPTICA

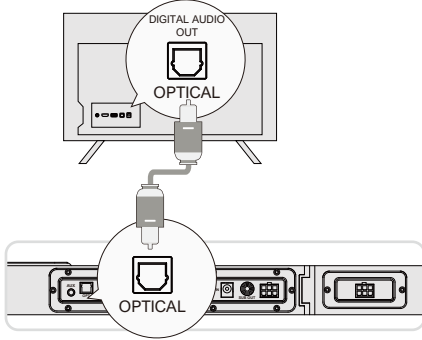

OPCIÓN 1: ÓPTICA

- 1 Asegúrese de que el cable está conectado al puerto OPTICAL OUT del televisor y el otro extremo al puerto OPTICAL de la barra de sonido.
 - 2 Asegúrese de que el conector óptico está insertado correctamente como se muestra en la imagen. No inserte el enchufe al revés y rompa el conector óptico.
- Nota:** Si se reproduce audio por los altavoces internos del televisor, silencio o minimice el volumen del televisor.

AUX

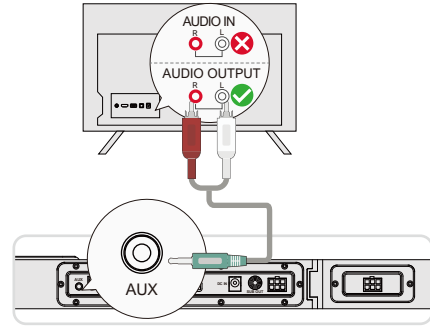

OPCIÓN 2: AUX

- 1 Conecte el cable de audio de 3.5 mm a RCA para conectarlo al puerto RCA AUDIO OUT de su TV.
 - 2 Asegúrese de que el color de los extremos de los cables coincide con el color de los puertos del televisor.
- Nota:** Recuerde desconectar el cable AUX del televisor y de la barra de sonido cuando desee cambiar de modo.

En modo óptico: Si no hay sonido, pruebe a ajustar la salida de audio del televisor a PCM:
Ajustes TV > Inicio > Ajustes > Sonido > Salida de audio digital > PCM

8 CONECTAR CON BLUETOOTH®

- 1 Pulse el botón "Bluetooth" de la barra de sonido o del mando a distancia para acceder al modo de emparejamiento Bluetooth.
- 2 Abra la configuración Bluetooth de su teléfono, busque y seleccione "Nova S70" para conectar la barra de sonido.

Nota: Si ya está en modo Bluetooth y conectado, mantenga pulsado el botón "Bluetooth" durante 3 segundos para desconectar el dispositivo actual y conectarse a un nuevo dispositivo manualmente en su teléfono móvil / PC / TV.



9 OPCIONES DE COLOCACIÓN

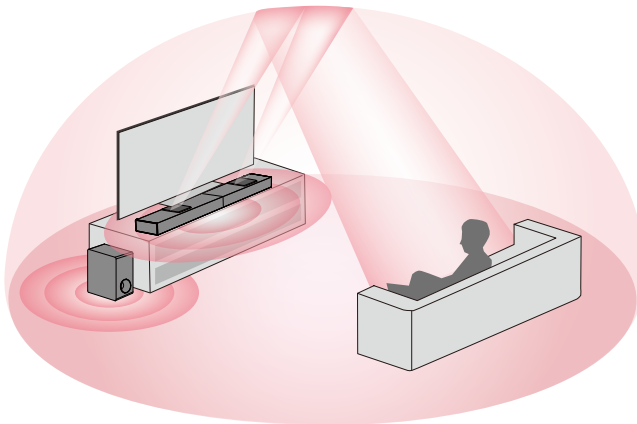

Nota: La barra de sonido debe colocarse a la altura del oído o cerca de él.

10 INSTALACIÓN EN PARED

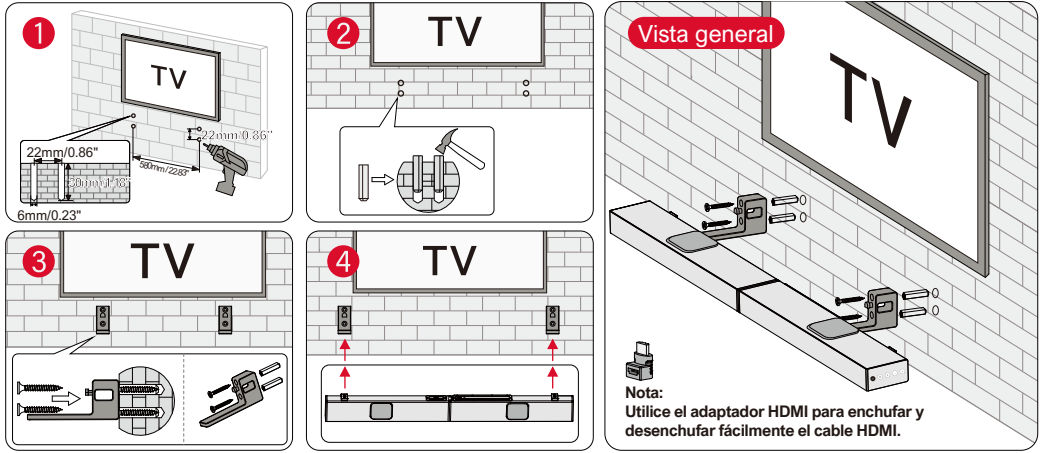

ES

11 ESPECIFICACIONES

Número de modelo	U3920
Fuente de alimentación	AC 100-240V, ~50 / 60Hz
Transductores de la barra de sonido	(3.1" x 1.2") x 3 (barra de sonido) + 1.8" x 2 (transductores ascendentes) + 5.25" x 1 (subwoofer)
Respuesta en frecuencia	45Hz - 18kHz
Potencia en espera	<0.5W
Temperatura de funcionamiento	0°C - 45°C / 32°F - 113°F
Visión Bluetooth	5.3

Dimensiones y peso		
Barra de sonido	800(W) x 38(H) x 90(D)mm	31.5" x 1.5" x 3.5"
Subwoofer	270(W) x 115(H) x 270(D)mm	10.6" x 4.5" x 10.6"
Embalaje	332(W) x 432(H) x 190(D)mm	13.1" x 17" x 7.5"
Peso neto	4.15kg / 9.15lbs	
Peso bruto	5.1kg / 11.24lbs	

SAFETY INSTRUCTIONS

Please read this user manual carefully and save it for future reference.

Do not make unauthorized alterations to the product, doing so may compromise safety, regulatory compliance, system performance, and may void the warranty.

- Avoid dropping.
- Do not disassemble.
- Do not submerge in water.
- Avoid extreme temperatures.
- Do not use the device outdoors during thunderstorms.
- Use original or certified cables.
- Do not place dangerous items on top of this device (e.g. liquid filled objects, lit candles).
- Clean with a dry, soft lint-free cloth. Do not use any corrosive cleaner or oil.
- To avoid hearing damage, do not listen for extended periods at high volume.
- Do not expose the batteries to extreme heat sources such as direct sunlight or open flames.
- The ideal operating temperature for this product and its accessories is between 41°F/5°C and 95°F/35°C.
- The adapter should be installed near the device and should be easily accessible.
- Do not use this product in environments of extreme heat or cold. Never expose this device to strong sunshine or wet environments.

PROPER DISPOSAL INSTRUCTIONS



This mark shown on the product or its packaging, indicates that this product should not be disposed of with other household waste at the end of its working life.

To prevent possible harm to the environment or human health from uncontrolled waste disposal, please separate this from other types of wastes and recycle it responsibly to promote the sustainable reuse of material resources.

Waste Electrical & Electronic Equipment

Household user should contact either the retailer where they purchased this product, or their local government office, for details of where and how they can take this item for environmentally safe recycling.

Business users should contact their suppliers and check the terms and conditions of the purchase contract. This product should not be mixed with other commercial wastes for disposal.

FCC REGULATORY COMPLIANCE

NOTE: This equipment has been tested and found to comply with the limits for a Class B digital device, pursuant to part 15 of the FCC Rules. These limits are designed to provide reasonable protection against harmful interference in a residential installation. This equipment generates uses and can radiate radio frequency energy and, if not installed and used in accordance with the instructions, may cause harmful interference to radio communications.

However, there is no guarantee that interference will not occur in a particular installation. If this equipment does cause harmful interference to radio or television reception, which can be determined by turning the equipment off and on, the user is encouraged to try to correct the interference by one or more of the following measures:

- Reorient or relocate the receiving antenna.
- Increase the separation between the equipment and the receiver.
- Connect the equipment to an outlet on a circuit different from that to which the receiver is connected.
- Consult the dealer or an experienced radio / TV technician for help.

Any changes or modifications not expressly approved by the party responsible for compliance could void the user's authority to operate the equipment.

This device complies with Part 15 of the FCC Rules.

Operation is subject to the following two conditions:

- (1) This device may not cause harmful interference.
- (2) This device must accept any interference received, including interference that may cause undesired operation.

This equipment complies with FCC radiation exposure limits set forth for an uncontrolled environment. This equipment should be installed and operated with a minimum distance of 20cm between the radiator & your body. This transmitter must not be co-located or operating in conjunction with any other antenna or transmitter.

ISED WARNINGS

This device contains licence-exempt transmitter (s) / receiver (s) that comply with Innovation, Science and Economic Development Canada's licence-exempt RSS (s). Operation is subject to the following two conditions:

- (1) This device may not cause interference.
- (2) This device must accept any interference received, including interference that may cause undesired operation of the device.

L'émetteur/récepteur exempt de licence contenu dans le présent appareil est conforme aux CNR d'Innovation, Sciences et Développement économique Canada applicables aux appareils radio exempts de licence. L'exploitation est autorisée aux deux conditions suivantes:

- (1) L'appareil ne doit pas produire de brouillage;
- (2) L'appareil doit accepter tout brouillage radioélectrique subi, même si le brouillage est susceptible d'en compromettre le fonctionnement.

This equipment complies with IC exposure limits set forth for an uncontrolled environment. This equipment shall be installed and operated with a minimum distance of 20cm between the radiator & body.

Cet équipement est conforme aux limites d'exposition IC définies pour un environnement non contrôlé. Cet équipement doit être installé et utilisé avec une distance minimale de 20cm entre le radiateur et la carrosserie.

Declaration of Conformity

We (Manufacturer is responsible for this declaration)
Dyanic (Shenzhen) Technology Limited
(Company name)

20th Floor, Building 4, Tianan Cloud Park, Bantian St.,
Longgang District Shenzhen, China 518000
(Company address)

Declare under our sole responsibility that the product
Trade Mark: ULTIMEA
Product Name: Nova S70 3.1.2 Channel Dolby Atmos Soundbar
Model No.: U3920
To which this declaration relates is in conformity with
the essential
requirement set out in the Council Directive on the
Approximation of the laws of the Member States
relating to RED Directive (2014/53/EU) & RoHS (2011/
65/ EU) product is responsible to affix CE marking, the
following standards were applied:

EN 55032:2015/A11:2020
EN 55035:2017/A11:2020
ENIEC 61000-3-2:2021
EN 61000-3-3:2013/A1:2021
ETSIEN 301 489-1 V2.2.3(2019-11)
ETSIEN 301 489-17 V3.2.4(2020-09)
EN 300 328 V2.2.2(2019-07)
EN 50663:2017
ENIEC 62368-1:2020+A11:2020
IEC62321-3-1:2013
IEC 62321-4:2013+A1:2017
IEC 62321-5:2013
IEC 62321-6:2015
IEC 62321-7-1:2015
IEC 62321-7-2:2017
IEC 62321-8:2017

Full Name: Yoyo.Yu
Position: Approbation Manager
Signature: 
Place/Date: Shenzhen, China/Dec. 25-2022

Trade Marks:



Dolby, Dolby Vision, Dolby Atmos, and the double-D symbol are registered trademarks of Dolby Laboratories Licensing Corporation. Manufactured under license from Dolby Laboratories. Confidential unpublished works. Copyright© 1992-2021 Dolby Laboratories. All rights reserved.



The Bluetooth® word mark and logos are registered trademarks owned by Bluetooth SIG, Inc. and any use of such marks by Soundlab Technology Co.,Ltd. is under license. Other trademarks and trade names are those of their respective owners.



The Adopted Trademarks HDMI, HDMI High-Definition Multimedia Interface, HDMI trade dress and the HDMI Logos are trademarks or registered trademarks of HDMI Licensing Administrator, Inc. in the United States and other.

ULTIMEA





Nova S70 3.1.2 Channel Dolby Atmos Soundbar
Model No.: U3920

 Dyanic GmbH
Buchenring 57, 22359 Hamburg, Germany

 UK Crossborder limited
7 Bell Yard London WC2A 2JR, UK United Kingdom

Made in China
Manufacturer: Dyanic (Shenzhen) Technology Limited
Address: 20th Floor, Building 4, Tianan Cloud Park, Bantian St.,
Longgang District, Shenzhen, China 518000

If you need our support, kindly reach out to our
service team. We are always glad to help.

+1 888-598-8875 (US)
Mon-Fri 9am-5pm (PST)
+49 89-628-25828 (EU)
Mon-Fri 9am-5pm (CET)
 support@ultimea.com
 support@ultimea.de
 support@ultimea.com
 support@ultimea.de



@ultimea_official