

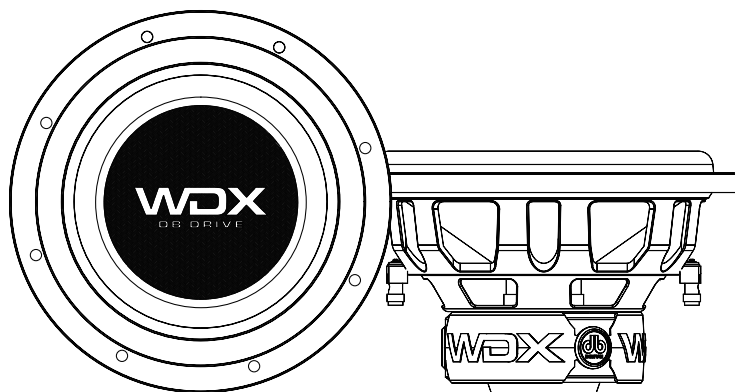

WDX GO

WDX8G0.2

WDX8G0.4 | WDX10G0.4 | WDX12G0.4



USER MANUAL

Due to continuous improvement of the product, specifications are subject to change without notice.

Introduction:

Congratulations on your purchase of a DB Drive state-of-the-art subwoofer. Your selection of a DB Drive car audio product indicates a true appreciation of fine musical reproduction. Whether adding to an existing system or including your DB Drive subwoofer in a new system, you are certain to notice immediate performance benefits.

Product Commitment:

DB's engineering professionals harnessed years of expertise, experience and passion, coupled with exhaustive testing and creative design to develop the optimal product and performance for your musical enjoyment. This is our commitment to you. It's what you deserve and have come to expect from DB DRIVE. We appreciate your confidence and look forward to your positive experience.

Keep Your Sales Receipt:

Take this time to attach your sales receipt to the manual and put it in a safe place. In case of any unforeseen reason this product may need warranty service, your receipt will be necessary to establish purchase date.

Recommendation:

A subwoofer's performance is only as good as its installation. Proper installation will maximize the system's overall performance. It is recommended that you have our product installed by an authorized DB Drive retailer. However, if you decide to install it yourself, please carefully read through this manual and take your time to do a quality installation.

Optimal Product Choice:

To get the maximum performance out of your stereo system, we recommend using 100% authentic DB Drive electronics and DB LINK wiring and accessories. Matching DB Drive amplifiers and Speakers with your state-of-the-art electronics purchase is critical to optimize your system's performance. Wiring is the lifeblood of a system, make sure your audio system has the adequate current and signal transfer it deserves and needs. DB Link has it all, from wiring rolls; Speaker, power, ground and remote to amplifier kits, RCAs, Fuse holders, distribution blocks and battery connectors. Insist on getting the best, DB LINK. It's what you deserve to get the optimum performance from your audio system.

IMPORTANT!

Before making any connections, disconnect the car's battery until the installation is completed to avoid possible damage to the electrical system.

WARNING!

Exposure to a high power sound system can cause hearing loss or damage. Listening to your system at loud levels while driving will impair your ability to hear traffic sounds and emergency vehicles. Use common sense when listening to your system.

Serial # _____ Model # _____

PRODUCT FEATURES

- High Temperature Voice coil
- Reinforced paper cone
- Double stitched foam surround
- Dual poly-cotton dampeners
- Stamped Cast basket
- Rubber gasket trim ring
- Large gauge compression terminals
- Protective magnet cover

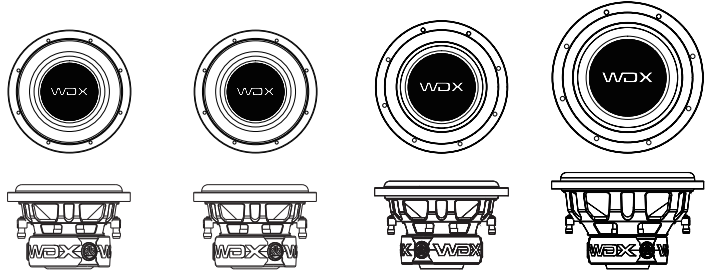

	WDX8G0.2	WDX8G0.4	WDX10G0.4	WDX12G0.4
Structure:	8" (20.3cm) Woofer	8" (20.3cm) Woofer	10" (25.4cm) Woofer	12" (30.4cm) Woofer
Max Power:	800 Watts	800 Watts	1000 Watts	1200 Watts
Nominal Power:	400 Watts	400 Watts	500 Watts	600 Watts
Impedance:	2" (50.8mm) 2Ω Dual Voice Coil	2" (50.8mm) 4Ω Dual Voice Coil	2.5" (63.5mm) 4Ω Dual Voice Coil	2.5" (63.5mm) 4Ω Dual Voice Coil

PRODUCT SPECIFICATIONS

T/S PARAMETERS	WDX8G0.2	WDX8G0.4	WDX10G0.4	WDX12G0.4
Resonant Frequency (fs)	42.074 Hz	41.702Hz	38.074 Hz	34.798 Hz
DC Resistance (Re)	1.6Ω x 2	3.2Ω x 2	3.4Ω x 2	3.4Ω x 2
Mechanical Q (Qms)	2.651	2.230	2.370	2.876
Electromagnetic Q (Qes)	0.481	0.447	0.580	0.673
Total Q (Qts)	0.407	0.372	0.466	0.545
Compliance Equivalent Volume (Vas)	9.554m	8.417m	18.768m	34.645m
Mechanical Compliance of Suspension (Cms)	150.779u M/N	132.844u M/N	100.274u M/N	86.553u M/N
BL Product (BL)	6.851 N/A	9.745 N/A	11.051 N/A	11.556 N/A
Diaphragm Mass inc. Airload (Mms)	94.901 gr	93.321 gr	174.262 gr	241.691 gr
Sound Pressure Level (SPL)	83.6 dB	84.3 dB	84.4 dB	85.2 dB
X-Max	11 mm	11 mm	14 mm	14 mm

PRODUCT DIMENSIONS

- A** Frame Diameter
- B** Mounting Depth
- C** Cutout Diameter

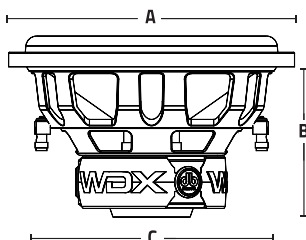

	WDX8G0.2 / WDX8G0.4	WDX10G0.4	WDX12G0.4
A Frame Diameter:	8.42 in. (214 mm)	10.70 in. (272 mm)	12.40 in. (315 mm)
B Mounting Depth:	4.62 in. (117.50 mm)	5.84 in. (148.50 mm)	6.51 in. (165.50 mm)
C Cutout Diameter:	6.90 in. (175.38 mm)	9.07 in. (230.57 mm)	10.85 in. (275.79 mm)

RECOMMENDED ENCLOSURES

The purpose of the information below is to help you select the most appropriate type of enclosure for your application. We have selected the two most popular enclosure types and their performance benefits.

Sealed Enclosure: (Air-Suspension design): Characteristically simpler to make, sealed enclosures usually are better at controlling the woofer's excursion and performance at lower frequencies. The added control allows for higher power handling or the use of a bigger amplifier. The secret is to maintain a perfect seal. Using glue and sealants at all seams is recommended to prevent leaks and integrity of the enclosure. The size or volume of the enclosure will directly affect the performance of the woofer. Smaller enclosures generally provide the desired bump to the frequency response curb and Greater SPL. Larger enclosures will provide a lower but flatter response for deeper bass. In general, the benefit of the sealed enclosure versus a ported enclosure is a smaller footprint, simpler build with higher power handling, a more linear flat response, superior sound quality and extended low frequency output.

Ported Enclosure: (Bass-Reflex or Vented): A ported enclosure is simply a sealed enclosure with a port or vent added to the sealed design for the purpose of tuning the enclosure to higher output at the desired tuned frequency, typically 3db or higher. Another advantage of a ported enclosure is the reduction of cone motion for the speaker, thus distortion at higher power levels within the tuned frequency response of the port. A drawback is that building a ported enclosure is more complex than a sealed enclosure. Having the wrong port or vent could result in poor sound, and the potential of damaging a woofer when played too loud or out of the tuning frequency. Thus, we recommend not guessing, please follow the guidelines listed in this manual or go to a professional. In General, the benefit of a ported enclosure versus a sealed enclosure is higher volume output at the tuned frequency and stronger bass output with lower power input.

Construction: We recommend using ¾" MDF (Medium Density Fiberboard) for the construction of an enclosure. It is critical for the side walls of the enclosure not to flex due to the pressure generated by the woofer, bracing might be required. The enclosure sides should be secured together with nails/screwed. We also recommend the use of glues and sealants to maintain the integrity of the enclosure and eliminate leaks.

RECOMMENDED ENCLOSURES

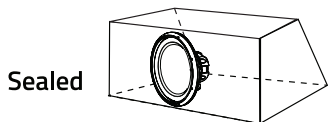

Sealed

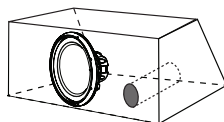

Vented

ENCLOSURES:	WDX8G0.2 / WDX8G0.4	WDX10G0.4	WDX12G0.4
Woofer Cut-out:	6.90 in. (175.38 mm)	9.07 in. (230.57 mm)	10.85 in. (275.79 mm)
Mounting Depth:	4.62 in. (117.50 mm)	5.84 in. (148.50 mm)	6.51 in. (165.50 mm)
Sealed Box:	0.7 cu ft. (19.82 L)	0.8 cu ft (22.65 L)	1.4 cu ft. (39.64 L)
Vented Box:	0.9 cuft. (25.49 L)	1.39 cu ft. (39.36 L)	1.4 cu ft. (39.64 L)
▪ Vent Area:	7.06 sq in. (45.6 cm ²)	12.57 sq in. (81.57 cm ²)	12.57 sq in. (81.57 cm ²)
▪ Vent Length:	8 in. (20.32cm)	13in (33.02cm)	14in (35.56cm)
▪ Tuning:	45Hz	40Hz	36Hz
Dynamic Power :	800 Watts	1000 Watts	1200 Watts
Nominal Power :	400 Watts	500 Watts	600 Watts

CALCULATING ENCLOSURES

It is recommended to build your enclosure from at least 3/4" thick MDF (medium density fiber board). Make sure the enclosure is sealed airtight.

▪ Calculating External Volume

To calculate box volume, measure the outside Width x Height x Depth of the enclosure. *Example 12" x 14" x 9" = 1512*

Next you must convert cubic inches into cubic feet. To do this, you must divide the cubic inches total by 1728". *Example 1512 ÷ 1728 = .875 Cubic feet.*

Calculating Internal Volume

- To calculate the internal (net) volume of the above box you must first multiply the thickness of the wood you are using by Two(2). *Example 3/4" x 2 = 1.5"*

Next subtract 1.5 from each of the outside measurements of the box.

Width	Height	Depth
12 - 1.5 = 10.5	14 - 1.5 = 12.5	9 - 1.5 = 7.5

Multiply the new totals (H x W x D) *Example: 10.5 x 12.5 x 7.5 = 984.375*

Next you must convert cubic inches into cubic feet. To do this, you must divide the cubic inch total by 1728". *Example 984.375 ÷ 1728 = .5696 cubic feet.*

DVC WIRING CONFIGURATIONS

You can change the wiring configuration of your speakers (Series, Parallel and Series / Parallel) to match the impedance loads that maximizes the power output of you amplifier. Wiring the same woofer or multiple woofers in these three different wiring configurations will result in different impedance loads.

Series: Is the method of wiring of alternate positive with negative terminals (string method) (Illustration below)

Parallel: Is the method of wiring where you wire match 2 speaker terminals with positive to positive terminal and negative to negative. (Illustration below)

Series/Parallel: This configuration is a combination of both series and parallel. We recommend series for the terminal and parallel for the leads to amp. (Illustration below)

1 X 2Ω DVC
SUBWOOFER

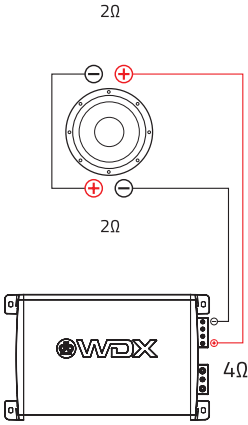

■ SERIES ■

1 X 2Ω DVC
SUBWOOFER

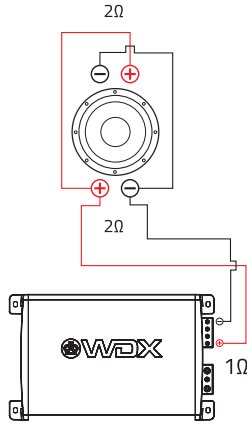

■ PARALLEL ■

2 X 4Ω DVC
SUBWOOFER

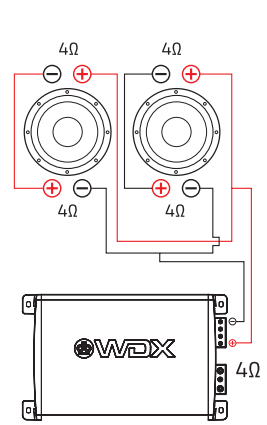

■ SERIES/PARALLEL ■

2Ω DVC WIRING CONFIGURATIONS

1 X 2Ω DVC
SUBWOOFER

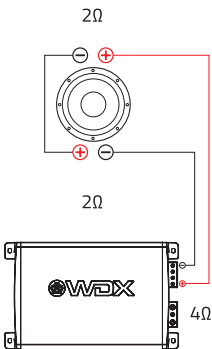

1 X 2Ω DVC
SUBWOOFER

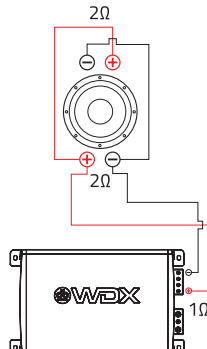

2 X 2Ω DVC
SUBWOOFERS

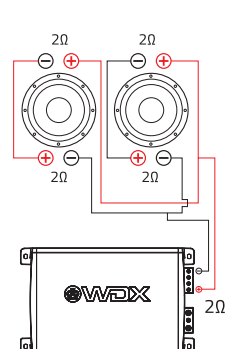

3 X 2Ω DVC SUBWOOFERS

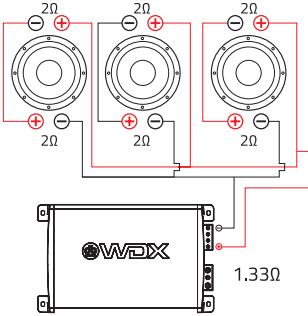

4 X 2Ω DVC SUBWOOFERS

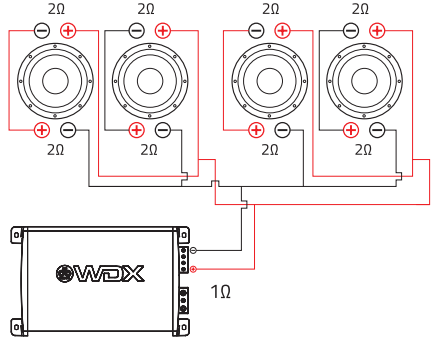

4Ω DVC WIRING CONFIGURATIONS

1 X 4Ω DVC SUBWOOFER

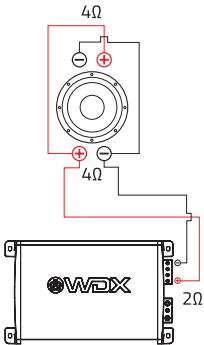

2 X 4Ω DVC SUBWOOFER

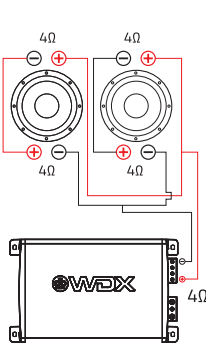

2 X 4Ω DVC SUBWOOFER

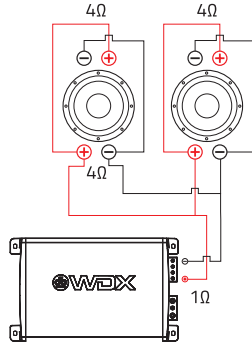

3 X 4Ω DVC SUBWOOFER

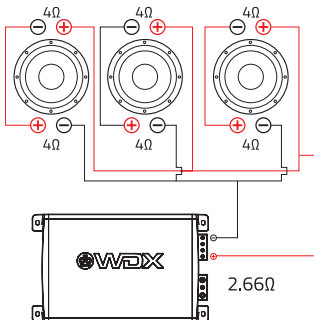

4 X 4Ω DVC SUBWOOFER

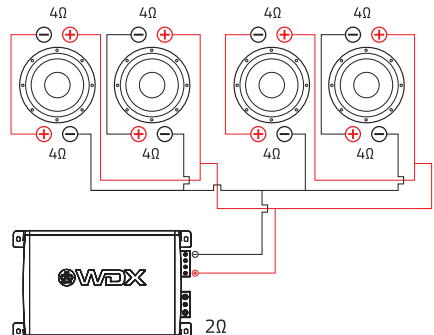

LIMITED WARRANTY

DB Drive™ warrants any products purchased in the U.S.A. from an authorized DB Drive™ dealer.

All products are warranted to be free from defects in material and workmanship under normal use and service for a period of one (1) year.

This warranty applies to the original purchaser only.

DB Drive™ will either repair or replace (as its option) any unit that has been found to be defective and under warranty provided the defect occurs within the one (1) year warranty period.

This limited warranty does not extend to units that have been subjected to misuse, abuse, neglect, or accident. In DB Drive™'s judgment, products that show evidence of having been altered, modified, or serviced without DB Drive™'s authorization, will be ineligible under this warranty.

To obtain warranty service please contact your retailer or visit our website at www.dbdrive.net for more details.



DB Research L.L.P. ■ 302 Hanmore Industrial Parkway ■ Harlingen, TX 78550
Ph: (877) 787-0101 ■ Fax: (956) 421-4513 ■ tech support: support@dbdrive.net

Designed and Engineered in the U.S.A. 